

COMBAT *KNIFE THROWING*

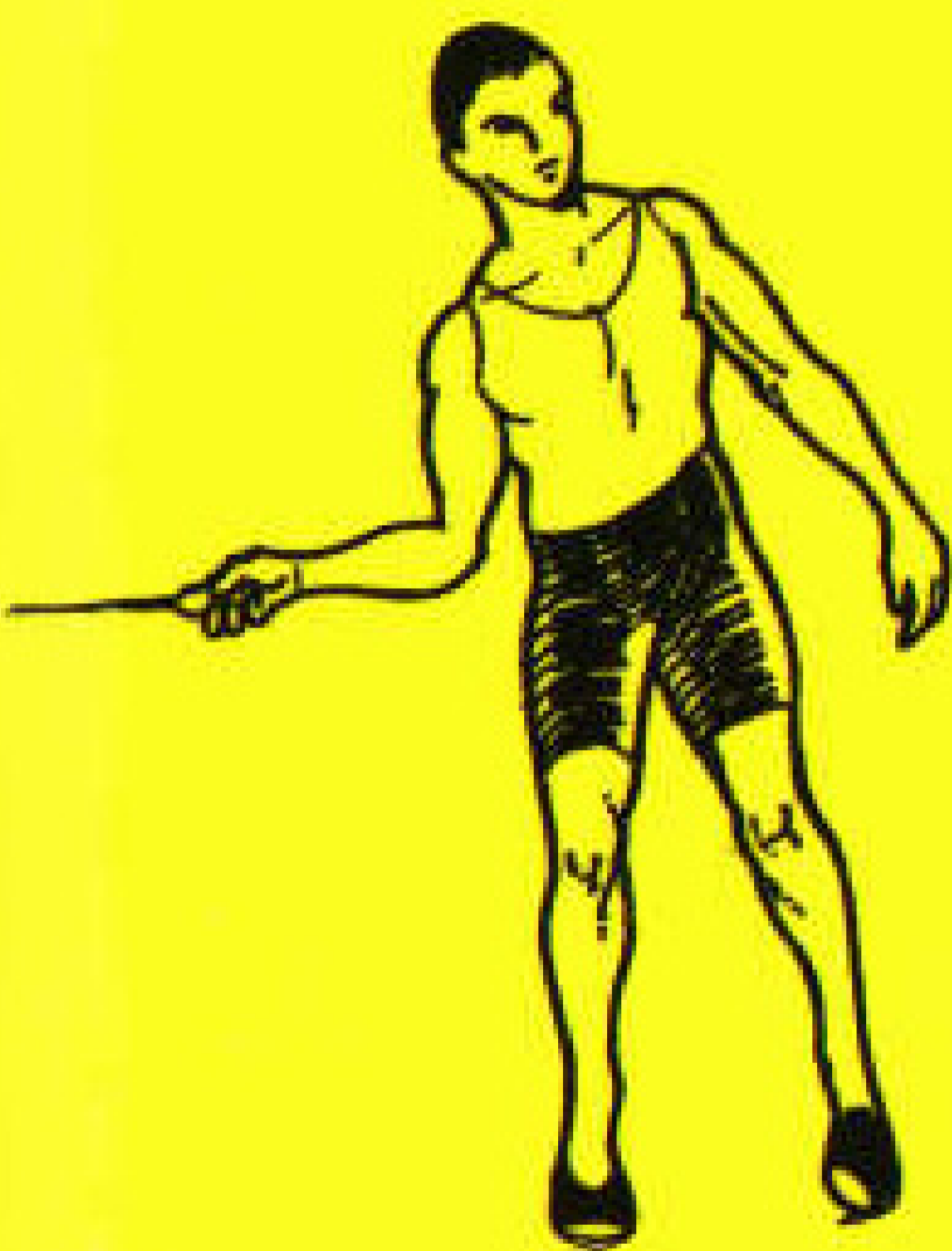

A
New Approach



to
Knife Throwing

and
Knife Fighting

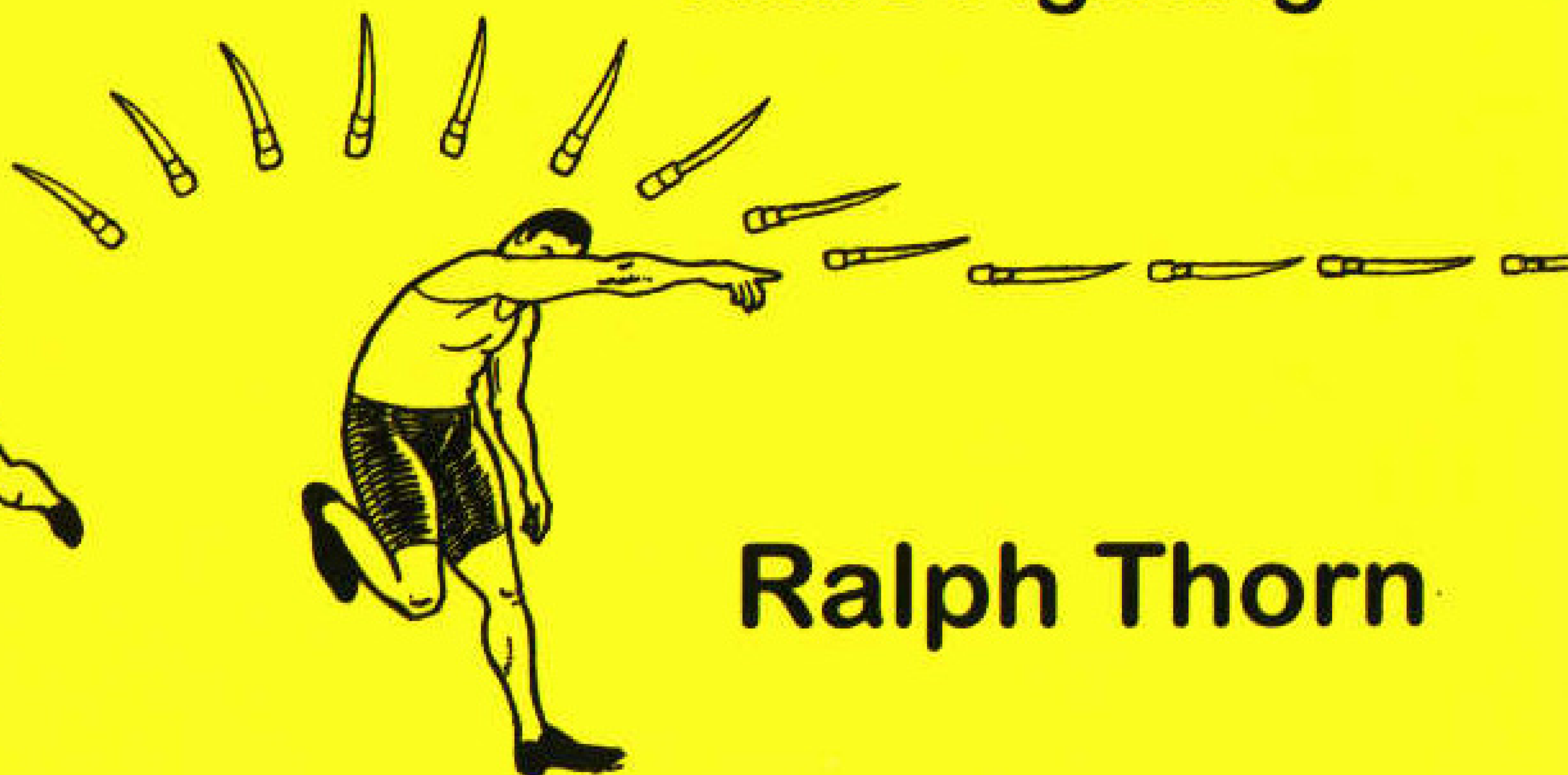

Ralph Thorn

Neither the author nor the publisher assumes any responsibility for the use or misuse of information contained in this book. It is sold for entertainment purposes only. Be warned!

Combat Knife Throwing

A New Approach to Knife Throwing and Knife Fighting
© 2002 by Ralph Thorn

All rights reserved. No part of this book may be reproduced or stored in any form whatsoever without the prior written consent of the publisher. Reviews may quote brief passages without the written consent of the publisher as long as proper credit is given.

Published by:

Loompanics Unlimited
PO Box 1197
Port Townsend, WA 98368

Loompanics Unlimited is a division of Loompanics Enterprises, Inc.
Phone: 360-385-2230
Fax: 360-385-7785
E-mail: service@loompanics.com
Web site: www.loompanics.com

Cover and illustrations by Ralph Thorn

ISBN 1-55950-227-4

Library of Congress Card Catalog Number 2002103993

Contents

Introducing Spear-Style and Combat Knife Throwing	1
Chapter One	
Balancing a Knife for Throwing.....	13
Chapter Two	
Targets and Safety.....	35
Chapter Three	
Spear-Style Knife Throwing.....	49
Chapter Four	
Combat Knife Throwing.....	73
Chapter Five	
Psychological and Physical Conditioning.....	97
Chapter Six	
Hunting and Recreational Skills.....	105

Introducing Spear-Style and Combat Knife Throwing

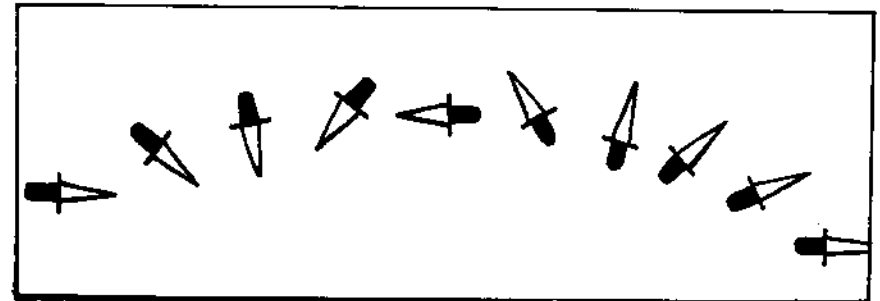

Figure 1

A throwing knife whose weight is in its front end will turn circles in the air, making it difficult to stick into a target.

Conventional wisdom among knife-fighting experts has it that knife throwing is a pursuit best left to circus performers, hillbilly theme parks, and hobbyists and that it is useless for combat or other survival purposes. You see, the only realistic way to seriously hurt someone or something with a thrown knife is to get a “penetration” (stab, as opposed to slash) wound, and the only way to get said stab wound is to, unsur-

Combat Knife Throwing A New Approach to Knife Throwing and Knife Fighting

2

prisingly enough, hit the target/victim with the knife point-first (called a "stick" in knife-throwing parlance). And you see, child, it is difficult, almost impossible, to stick a knife into unpredictably moving targets. As every one of the handful of knife-throwing manuals, hunting magazine articles, or Internet fan sites in existence seem to state explicitly (when they don't assume you already know), since a knife inevitably turns handle-over-blade circles in its natural flight path (a phenomenon variously called "spin," "rotation," or "revolution"), the only way to throw one and stick it into a target more than a step or two away is to perform the following process: Carefully measure the distance it takes for a particular knife, thrown by a particular person, to make a particular number of revolutions — one-half, one, two, etc. — and then have that exact person always throw that exact knife, from that exact distance, at that exact speed, to achieve that exact number of rotations, and thus a stick. If you throw by the handle and the knife revolves around precisely once as it travels to the target, presto — it hits point-first on impact. If you throw by the blade and it revolves exactly one and one-half times — you again get a stick.

The trick, then, is just to always stand the same distance away for each of these throws and to throw them so that the knife always revolves at the same rate of speed. You thus have, say, a one-half-spin throw you use at 4' 6", a full-spin throw that you throw from 9 feet, a spin-and-a-half at 12 feet, and so on, with various tricks and variations thrown in (no pun intended) for variety. Unless you are able to vary this rate of speed at which the blade rotates, which leads to far less consistently sticking the target and is thus ordinarily discouraged, the areas in between these set distances are ignored. (It should be noted that the rate of speed of this rotation is not the same as the speed at which the knife travels to the target, just how fast it is flipping over itself as it does so, though both must remain constant in this method of throwing.)

Introducing Spear-Style and Combat Knife Throwing

3

Professionals, while they throw very accurately at still targets, always throw from a same few measured distances. Throwing from in between them would cramp their style and result in the knife bouncing off the target; it is therefore considered pointless (pun intended).

Only at a distance of a pace or so, they say, is it possible to simply hold a knife by the handle — falsely assumed, I suppose, by the naive masses of a bread-buttering public to be the *only* way to hold a gosh-darn knife — and throw it point-first and get a stick. Even from mere feet away the knife will spin around enough to cause it to hit with the flat of the blade or the butt of the handle. The throwing knives you see advertised as such, aside from being nearly handleless and guardless, are obviously balanced to have their weight disproportionately in the front end, just to turn over in the air — rotate — more quickly and predictably.

Similarly, the sport is closely linked to hatchet throwing, where the weight of the weapon is distributed likewise (a comparatively light handle with a heavy head). All this obviously means that it is impossible to stick any target if any one of three conditions occurs: a.) you move non-laterally relative to the target (toward or away from it) a few inches as you throw; b.) the target does likewise; or c.) both a and b. This is easy enough to prevent at the circus, but in fighting or hunting situations these are not entirely unlikely events, and the practical uses of knife throwing are thus rightly relegated not to the arts of combat or survival but to the art of performance, where girls attach themselves to spinning wooden wheels while rhinestone cowboys standing a couple of steps away define their silhouettes in flashing metal; where celluloid Bowie knives regularly fly end-over-end for forty feet, evidently in blissful ignorance of their ineffectiveness in the real world, and cause instant death to mustachioed serial villains wearing black hats.

Combat Knife Throwing A New Approach to Knife Throwing and Knife Fighting

4

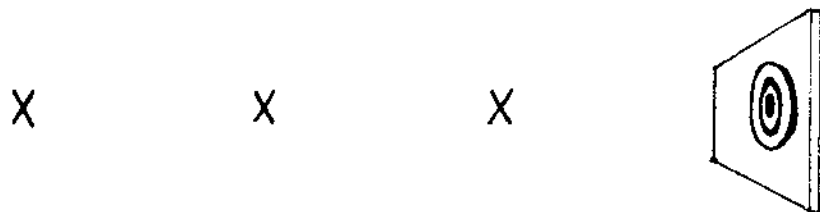

Figure 2

Like other types of performers, circus knife throwers must "hit their marks" — they can only throw from set locations.

Only those ignorant of the basic mechanics of knife throwing could believe in such a thing as this latter. They are probably the same people who think Jean-Claude van Damme and Steven Seagal are real butt-kicking martial artists. And anyway, those little throwing knives you see in the catalogs just aren't big and heavy enough to have "stopping-power" capability. If you did manage to get lucky and hit somebody point-first you'd probably just bounce it off their sternum or forearm and do nothing more than make them mad, in addition to losing your weapon — although this would at least have the dubious benefit of ending the suspense over the fight's outcome.

It is reasonable among experts, such as they are, to assume that anybody who thinks there is such a thing as combat knife throwing just doesn't know what he is talking about. If you get into a knife fight keep your knife in your hand, and if some fool tries to throw his at you, simply put an arm block in front of your face, take one step forward or back, watch the butt-end of his blade bounce harmlessly off your arm and hit the

Introducing Spear-Style and Combat Knife Throwing

5

ground, and then end the conflict according to the dictates of your conscience, for you are now doubly armed while he is disarmed and at your mercy.

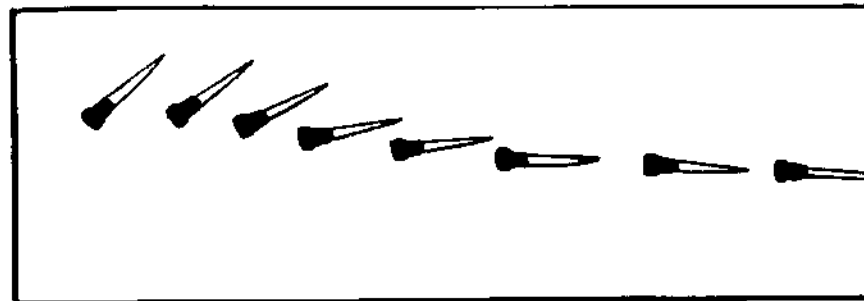

Figure 3

Throwing a knife point-first at a target, like you would a spear, is easy if the knife is balanced and gripped properly.

There is nothing wrong with such conventional wisdom regarding the usefulness of this style of knife throwing as a self-defense or survival tool. There *is* something *dramatically* wrong with the single assumption underlying this whole theory of knife throwing (which I hereafter call "circus throwing"). This assumption underlies the shape of seemingly every throwing blade forged since Wild Bill Hickcock toured the territory west of the Mississippi — knives which are then sold, presumably, to people who have somehow gotten circus-style throwing instructions and learn to throw them in this way, in a circular, self-perpetuating process. That assumption is, again, only this: that a knife leaving a human hand must tumble ungraciously end-over-end through the air if it is thrown any distance not measured in inches, as Moses declared from the mountaintop and Sir Isaac Newton decreed into law, and that

Combat Knife Throwing

A New Approach to Knife Throwing and Knife Fighting

6

knife-flinging mankind — and womankind — must learn to accept this simple commonsense limitation.

In fact, it is perfectly possible (and very easy) to change the balance of a knife or sword of nearly any reasonable size (roughly, from hunting-knife size up to 30 inches) so that it will fly point-first at a target several yards away *without the point ever dropping more than slightly, let alone rotating circularly*; that is, so that it will fly the way a spear or arrow flies. It is therefore perfectly possible to hit a target point-first with a knife from any range that your arm strength will allow, with a multiplicity of arm angles (overhand, underhand, side-arm, even around-the-back) whether it, or you, or both are moving in any direction as you do so. These targets can be hit hard enough to do them very serious damage, including instant fatal damage if you hit the right spots on a living target.

It is furthermore perfectly possible (though not quite as easy) to balance and throw that same knife in such a way as to be able to control the rate of speed at which it rotates in the air without seriously compromising the velocity with which it approaches the target. Thus, by varying that rate of speed, you can hit any target point-first from any distance equal to or less than the maximum range your ability gives you — again, not just the artificial set distances that circus throwers almost always stand at and throw from due to the inherent limitations of their style, but also that far vaster territory in between those set points.

It is not at all impossible, by using either of these two methods, to throw knives from real-time, real-life *variable* distances and angles, the same simple way you would throw a baseball (and every bit as accurately — in my case much *more* accurately — and most importantly, as accurately as circus-style throwing and with a greater chance of hitting the target point-first with far less practice). Forgive the repetition of this very simple concept, but it seems necessary to emphasize this

7

because practiced knife throwers of the circus style simply do not believe it, and people unfamiliar with knife throwing do not even realize that circus-style throwers cannot in fact simply throw knives from variable distances the way one would any other object. (I will not further insult your intelligence by stating the *desirability* of being able to throw a knife in much the same way you would throw a ball or, more ominously, shoot a bullet.) None of this takes any special equipment or talent — only some practice, a roll or two of tape, and a knife with its weight more in the handle end than the blade end.

This method, to say the least, changes the equation of the utility of knife throwing in life-or-death situations. It also has the benefit of making it a heck of a lot more fun to do, which will lead to getting that necessary practice more painlessly (if, perhaps, not less injuriously!).

I know these things are possible because I do them all the time, and have for years. My inspiration for putting my quiver full of knife-slinging techniques into writing is twofold: One, I want to make people aware of the nonsensical, self-imposed limitations of circus throwing, a style which even the majority of its adherents admit is useful only for entertainment purposes. Most of the advice given out by these types of throwers is, from the point of view of my experience, nearly totally useless to the layman at best, or dangerously ignorant and wrong at worst. (A glaring example of this would be the lunatic assertion in one pamphlet that the best combat throw is the backhand. It is categorically, inarguably, undeniably the *worst*, for at least four reasons I know of and will make clear in the chapter on combat. Here's a quick preview: It is slow developing, low velocity, leaves the thrower in poor defensive position both before and afterwards, and is woefully inaccurate in that it leaves one unable to significantly adjust the throwing angle to a moving target.) Two, I have a passion for knife throwing that I want others to share, and I am convinced that if

Combat Knife Throwing A New Approach to Knife Throwing and Knife Fighting

8

people who become exposed to knife throwing were not limited from the start by this inferior style that dominates the activity, more of them might find it appealing enough to try. After all, my style leads to greater power, mobility, range, and consistency in hitting things point-first than circus throwing ever could.

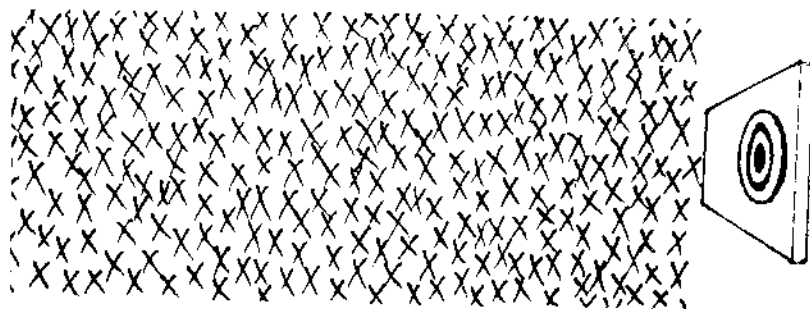

Figure 4

...and this means you can throw from anywhere and stick it in.

Personally, I rejected circus throwing from my first encounter with it simply because I hit upon my own throwing style and the concomitant methodology in actualizing it -- fancy words for wrapping tape on bayonet blades and chucking them at trees! -- in my early teens, without any instruction from anybody. By the time I got old enough to contract a disease particular to adults, the one which leads us to stop tinkering with things and "get serious" by seeking out experts to teach us to do things better than we think we can do them ourselves, I had already developed a skill level that I was unwilling to abandon in order to learn to do things the way the books said was "right." I could, in fact, already do what they all said on page one was undoable.

Introducing Spear-Style and Combat Knife Throwing

9

It all came about much by accident. I loved playing with knives almost from the cradle and had often tried throwing ordinary folding and hunting knives even as a preadolescent (even then I could juggle three of them at a time and I still have visible scars that remind me that I had to learn to do that, too). I quickly discovered the same thing as every kid who does so: It's hard as heck to control the way those things spin around in the air and get the point to hit whatever you're throwing at. I had given up on knife throwing when, not so long after, I accidentally broke the handle from a cheap sword I had by whacking the thing at shrubbery or some such. I made a new handle of duct tape, wrapped right around the back end of the blade itself instead of the no longer existent tang, so I could salvage it as an improvised machete. (The tang of a knife is the part of the blade that extends down into the handle.)

Playing with this new toy, I discovered that this much larger knife, since it rotated at a slower rate, was not only easier to toss and catch while juggling but *much* easier to control than a smaller knife when I threw it *at* things, especially if I threw it underhand instead of overhand. Even more importantly, simply by experimenting with the location and amount of tape on my homemade handles, I discovered that I could so stabilize the flight of the knife that it could travel virtually in a straight line for well over twenty feet without the point turning over at all -- even when thrown (overhand this time) by the skinny arm of a 100 pound boy.

Of course it wasn't long until I had an arsenal of sword, machete, and bayonet blades wrapped in various kinds of tape, to the great consternation, I am sure, of every tree and fencepost in half of Appalachia. (On Judgment Day, I had better hope old Jehovah is no treehugger). Within a couple of years I had even learned to throw much smaller knives, many of them just the (predictably) broken remnants of my swords and bayonet

Combat Knife Throwing
A New Approach to Knife Throwing and Knife Fighting

10

blades, with a range, accuracy, and velocity I never would have dreamed possible in the beginning. This in turn led to my rejecting the parameters internalized by the knife throwers and knife fighters in all the books and magazines, and to making new rules for my new game. I became a combat-oriented knife thrower.

For years I thought that, because I grew up throwing knives in this seemingly unique style that I developed, it would be nearly impossible for me to verbalize my methods and to thus show others how to duplicate them. Not only is my throwing so habitual and automatic that I am probably not even consciously aware of many of the things I do, but it is now nearly two decades since I was first learning to throw. How would I ever be able to relate it to a beginner when everything I had done with knives since my early teens had been aimed at making knife throwing such a reflex with me that my very nerves and muscles cannot remember a time when I could not do it?

This thinking of mine ended recently through another accidental epiphany. As usual, I threw much less in the summer due to the heat, and when I started throwing more again in the fall I overdid it and made my throwing arm sore. As a result, I somehow found myself doing something I have almost never done: throwing left-handed. I was so clumsy that I was forced to think about things I hadn't in years. Things like stance, grip, arm angle, balance, release, and developing velocity. This was such a delightful novelty that I've continued throwing a little while every day left-handed, bringing back to my frontal lobes all those little things about knife throwing that I long ago sent to my brainstem along with typing, drawing, and driving a car. I furthermore realized: If I can do it lefty (and I am improving at a surprising rate), it really *is* easy enough to be teachable. At the very least, it is easy relative to the complications of the circus style.

Introducing Spear-Style and Combat Knife Throwing

11

I can teach others to do it the same way I am teaching the other side of my body, since the observations I make while throwing left-handed apply almost perfectly to a rank beginner. Certainly I am not a physical freak, just an ordinary-sized man in his thirties with fairly coordinated hands and feet, who grew up carousing through the woods with a blade or three in his hand. (Actually, I still do that, so like some bizarro-world Peter Pan, maybe I never grew up.) Regardless, only now, thanks to belatedly rediscovering my own spirit of inquiry, have I even discovered that I can throw left-handed!

While this tract, then, is of unfortunate necessity often about me and my experience — since, while I suspect I am not entirely alone, to my direct knowledge I am the only person who throws this way — it is much more about the *possibilities* of knife throwing that do exist. These have been denied by all such baseless assumptions as I find even myself, who ought to know better, making, and by the evident total lack of either athleticism or experimentation from those in print who call themselves experts on knife throwing. It is intended to inspire others not so much to slavishly imitate my style as to identify and transcend all these silly limitations and continue what I only start here. Most of all, I want the next generation to grow up knowing that there is an alternative to throwing knives the way the current self-defined “experts” say. If this became a reality, it would change in short order the whole concept of the correct way to throw, and by extension, fight with, knives.

More accurately, I deny that there is one correct way, only a correct general approach that I try to present here, an approach that encourages as many ways to throw knives as there are future knife throwers. And if this is all only a tempest in a teapot, I am merely trying to say that you can pour out the whole tepid brew of the past and make a hundred flavors of coffee.

Combat Knife Throwing
A New Approach to Knife Throwing and Knife Fighting

12

The author would like to thank his younger sister and Officer J. Phillips, both of whom gave much needed assistance in producing this book (though in entirely divergent ways).

Chapter One
Balancing a Knife for Throwing

13

Chapter One
Balancing a Knife
for Throwing

Perhaps the easiest way to understand the basics of the style of knife throwing described here, especially if you are already familiar with conventional knife throwing, is to first realize why it bears no resemblance to hatchet throwing. Hatchets, and for that matter Bowie-type knives, are *tools* intended for purposes entirely different from throwing. As chopping and cutting instruments, they are much heavier in the front end than in the handle end. Their weight is thus asymmetrical; they are what I call "*front-heavy*."

Compare these to objects intended to be thrown or projected through the air like missiles: Their shape and weight is either totally symmetrical, as in the cases of footballs, flying discs, or cannonballs, or in the case of more elongated, pointed (and therefore more knifelike) objects such as spears, darts, or arrows, counterbalanced or stabilized in some way on the back end to prevent an unstable front end from dipping or wobbling in flight.

Conventional knife throwing seems to have evolved entirely from attempts to throw ordinary hunting or fighting knives, perhaps as a campfire pastime, without changing their balance

Combat Knife Throwing A New Approach to Knife Throwing and Knife Fighting

14

at all. (Obviously a frontiersman, soldier, or hunter of the past would not have wanted to alter the balance and thus performance of one of his most precious tools just for the purposes of sport, and certainly throwing hunting-type knives or hatchets are useless for anything but sport.)

What is remarkable is that even as knife throwing became a more specialized activity and moved into a corner of the entertainment industry, there seems to have been no effort to change the basic balance of the knives used so that their relatively heavy front end would not immediately start dropping as soon as they were thrown. A mass-produced, conventional (circus-style) throwing knife is symmetrical weight-wise in that its balance point is generally as close to its center as possible, but this does not address the basic problem. These knives still turn over themselves as they fly through the air; they just turn tighter circles instead of lopsided egg-shaped ellipses, as hatchets or Bowie knives do. The supposition is that the best way to have maximum control over a thrown knife is to control the way it rotates in the air, so precisely balanced "throwing knives," which are useless as cutting tools, are manufactured to turn over in the air more cleanly. This is another verse in the song that was playing while they were rearranging the deck chairs on the Titanic.

If you are going to abandon the use of a knife as a tool entirely and balance it specifically for throwing, why in the world should you still remain limited by the natural flight pattern of knives that are meant to remain as tools, and are balanced to remain in the hand? It seems curious, almost incredible, that none of the people who throw or manufacture these knives has ever simply developed a knife that will fly through the air without spinning around at all. After all, no one questions that it is possible to throw a spear with great effectiveness without the point turning over, since human beings sur-

Chapter One *Balancing a Knife for Throwing*

15

vived by doing so for thousands of years. (Some still do today.) On the flip side, it has never been demonstrated that it is feasible to hunt or fight with pointed weapons that rotate in the air (with the arguable exception of the throwing-star type of small throwing weapons, which spin like Frisbees when thrown and have multiple points that are intended to be poisoned, and so have less in common with knives than even spears). And it is clearly much easier to hit a target, from any distance, with the point of the knife when throwing spear style as opposed to hatchet style.

The superiority of the point-first, spear type of flight pattern to the rotating flight pattern of a hatchet should, in fact, be so obvious as to go without saying. The Olympic record for a javelin throw is over 340 feet. Why should it be assumed that it is impossible to throw a knife spear style, if it is balanced to do so, straight at a target from far more modest distances, like 15 or 20 feet? Has anyone ever tried to produce a knife that would?

The answer to this question is no, but fortunately you don't need to wait for anyone to manufacture a knife for you to throw in this way. You can cheaply and easily make one (or many) yourself out of a variety of different types of knives or even other objects.

Briefly, the method described here simply involves wrapping electrical tape on key areas of a large knife blade to create an entirely new handle, thereby changing the knife's balance point and dynamic behavior. This will allow it to fly at a target point-first for yards without rotating, if it is gripped and thrown correctly.

The knives you make will outperform any knife that could possibly be manufactured, for a variety of reasons. One, you can position the way the knife handle sits in your own individual hand, literally down to the millimeter, simply by wrapping

Combat Knife Throwing
A New Approach to Knife Throwing and Knife Fighting

16

tape in the right way, in the right areas. (For underhanded throws, especially, this is vitally important.) Two, you can easily adapt the balance of the knife. This will enable you to throw it for different purposes or at different ranges, as your ability level or performance preferences change. Another reason is that a knife with a broken point will remain serviceable, since you can easily rebalance it. (Knife points can break frequently in this style of throwing because of the variable angles and high velocities involved, and after you put a new point on one the missing weight will dramatically change the way the blade flies through the air. Remaking the handle will fix this.) Even if, by some miracle, knives intended for this type of throwing were mass-manufactured, the first thing you would want to do anyway would be to wrap some tape on it, just to fine-tune it to the shape and size of your hand and arm strength. I have never discovered a better way to make a throwing-knife handle, and have never needed to.

Before we start making these knives we need to get some terms straight or we will quickly have a tower of Babel collapse on us, since some of our language is new and some is unconventional. First: Any knife not balanced specifically for throwing is a tool of some other kind, not necessarily a throwing weapon. The word *knife*, then, when it is not assumed to mean throwing knife, will be preceded by an adjective describing its function as a tool: steak knife, hunting knife, combat knife. We will also call throwing knives *blades* for short, since we'll use this term so much and because that's what we're mostly going to make them of: big knife blades, but if we say *the blade of the knife*, it means what you always thought it meant; the naked metal part of the knife above the handle, whether it's a tape handle or not. (When we say *the plane of the blade*, we will be referring to whether the knife is lying like it is flat to the ground — a horizontal plane — or

Chapter One
Balancing a Knife for Throwing

17

standing on its edge like a coin that's neither heads nor tails — a vertical plane.)

And if knife throwing is to be anything more than a glorified vertical version of mumblety-peg, the balance of the knife must be modified to make it into an instrument specifically meant for throwing *spear style* — that is, thrown in such a way that it does not rotate in the air, which is clearly the most useful and sensible way to throw objects of this shape. We will call this undesirable phenomenon of a knife revolving in circles as it flies through the air *rotation*, because we want to reserve the word *spin* for something else, to be discussed later. (Also, the word *revolution* has connotations not appropriate to the conventional style of knife throwing, which we consider archaic. We will consider the style of knife throwing presented *here* to be revolutionary! Or should we make that *counter-revolutionary*, since the knife doesn't revolve? Forgive me — I digress....)

Even when we learn later to throw a knife at long range with a rotating flight pattern, the knives we use to do so will still be throwable spear style, as almost everything we do in balancing a throwing knife is intended to retard the rate of its rotation in the air. For the remainder of this book, the term *throwing knife* will refer to elongated metal objects flat enough to hold an edge, with a point on one end and a tape handle on the other, and specifically balanced to be thrown spear style, whether they are made out of butter knives, files, old lawnmower blades, or what have you. Any knife not so balanced is simply a tool intended for some other purpose, including those objects usually labeled as "throwing knives," which are a tool of the entertainment trade. These we will call *circus knives* until they are properly balanced for real throwing. After a sufficient probationary period in which their mettle (metal?) is tested and their honor suitably demonstrated, they might be so fortunate

Combat Knife Throwing
A New Approach to Knife Throwing and Knife Fighting

18

as to earn our designation of "throwing knife." Until then they are merely knife-like metal objects with the potential to become throwing knives.

If you've already invested in some expensive circus or combat knives, here's the good news: Even many of these can be easily modified to throw spear style, and doing so will not greatly reduce the ability of the knife to be an effective hand weapon or tool, if you wish it to remain so. Here's the bad news: There are other knives that will serve the purpose of throwing much better and they are generally less expensive.

The best throwing knife must possess the following characteristics:

- a. it must be made of a metal that is very difficult to break or bend;
- b. it must be as dense, as heavy, and as thick in the spine as possible;
- c. it must be able to hold a reasonably sharp point and edge;
- d. unless it is exceptionally thick and heavy, it must be at least 9 or so inches overall in length;
- e. it must be cheap enough for you to not care when it breaks, for it someday will.

These conditions are all met beautifully by old-fashioned "Mauser" bayonets. A bayonet, if you don't know, is a knife made to be attached to the barrel of a gun in order to give a soldier an available hand weapon. Some, called "spike bayonets," are not real knives at all but bladeless, pointed stabbing weapons. Some designs look like big Bowie knives. These types can be serviceable, but you can do much better. Another common design to avoid is the dagger-like American M4, issued during the Korean War era. The shape is great but it is a little too short.

The design that is best for our purposes is one that was popular around the turn of the century, with very recognizable

Chapter One
Balancing a Knife for Throwing

19

features including a screwed-on wooden handle and a heavy metal piece on the back with a protruding, retractable locking mechanism that attaches to a gun. These often come in a leather or metal sheath. The blade usually has a deep blood gutter — a groove running lengthwise through its center meant for, as the name implies, blood to run out of — only one edge sharpened all the way down, and either a point in the center (like a dagger has) or a wedge point.

This basic design is unmistakable once you have seen it. They are often called "Mauser" bayonets after one of the guns they were meant for. These come in various lengths, but most of them are longer than the kinds of bayonets manufactured later. They are made of a dense, tough metal that is hard to break, come with an original point that well suits our purposes, and have a blade which is exceptionally thick, but able to hold a good enough edge if necessary. Get the biggest you can if they are the same price; smaller ones are usually cheaper — ten bucks or less. It is quite an interesting comment on human nature that so many of these were manufactured all over the civilized world in the twentieth century that they are still floating around in surprisingly great quantities. (It is a further comment on human nature that some people consider these deadly objects to be collector's items.)

If you can't find some for sale, you can certainly get them by mail order. There is, of course, no reason to get ones in collectible condition. In fact, since you are going to tear them down and render them not only uncollectible but also nearly unrecognizable, you should look for old scratch-and-dent bayonets lacking sheaths or even handles at flea markets or sporting-goods store bargain bins. If you can't find any, by all means don't hesitate to tear a perfectly good bayonet apart, at least if you paid less than twenty bucks for it; with any luck at all it shall give you many years of service.

Combat Knife Throwing
A New Approach to Knife Throwing and Knife Fighting

20

If you have fallen victim to the collector mentality and would prefer to admire a bayonet or some fancy fantasy knife as it hangs on your wall rather than actually pull it out of its dusty sheath and use it for something, you are perhaps more interested in style than substance anyway. In this case you might do almost as well to take up circus throwing and ignore the rest of this book, since circus throwing appears quite stylish to those ignorant of its mechanics, but is utterly lacking in substance. Just make sure you don't get in any knife fights. At least not with anybody who finishes reading this book.

Another good choice, one about as affordable, is sword blades. Even relatively inexpensive swords of the kind you find at flea markets and gun shows (and yes, even those notorious Pakistani blades) are usually made from grades of metal that hold up fairly well for our purposes. Razor-sharp blades don't matter so much to us here; what matters most is the overall size, weight, and density of the metal. You should avoid severely curved swords, such as scimitars, or blades with any kind of drop-point (a point that curves downward), but a moderately curved blade, such as that of a samurai sword, is fine. In fact, unless the sword is nearly as thick at the spine as a bayonet, knives with a slight curve might be a little better for beginners, because they will have the effect of feeling heavier and thus more controllable. Get a sword that is functional, not some decorative blade that is made, as some samurai swords are, of aluminum alloy, which is useless for anything here. (Pure aluminum sheets, if they are at least an eighth of an inch thick, can be easily cut with rotary saws and made into serviceable and nearly indestructible practice knives, but this is really not recommended since these will be too soft to stick into wood consistently.) Avoid rapiers and similar thin-bladed swords; they aren't heavy enough and they will break too easily. You want a blade at least an inch wide.

Chapter One
Balancing a Knife for Throwing

21

Some other types of these would be ninja swords, broadswords, and sabers.

Some other common types of big knives, such as machetes, are usually to be avoided because the blades are too wide and not thick enough. This leads to bending and breaking of the knife and control problems (light, wide knives like this catch too much air and this destabilizes them). Another problem with this type of knife is the fact that they are usually too broad at the point end and would require a lot of cutting to get a good point for throwing.

If you think you have to use an oversized hunting knife, it is possible but not preferable. It needs to have either a Bowie-style point (one that turns upwards) or a dagger style (straight, and sharp on both sides). Again, drop-point knives, such as skinning knives, are true to their name when thrown — the point goes down like a rock, which is exactly what we don't want. Make sure this kind of knife has a handle as wide as the blade itself and a full tang, that is, that the bottom part of the blade, the part that the handle is attached to, is as wide as the part of the blade that shows and not just a little narrow tongue of metal disappearing into the center of the handle. Knives of this kind will need the weight of a full tang in the handle and a narrow tang will break quickly. A hunting knife meeting these qualifications is likely to be either custom-made or very expensive, so you should probably look away from big hunting or kitchen knives altogether. If you have a good functional machete or hunting knife and you are determined to throw it in this way, it might be best to just wrap tape in the manner described right around the existing handle. This knife probably won't perform as well as a bayonet or sword blade under any circumstances, especially if it has a large hand guard, so don't ruin it. Get better knives to practice with from the beginning and you may find much later that you can throw just about

Combat Knife Throwing

A New Approach to Knife Throwing and Knife Fighting

22

anything fairly effectively, even improvised throwing knives such as these.

As for conventional, so-called "throwing knives" (circus knives), some of these are actually perfect for our purposes, since they are often the correct size and shape. The "professional" type often lack handles and have only cursory guards, which means we don't even have to strip them down as much. Unless the hand guard is overlarge or the knife has some other weird extra metal shapes that need filing or cutting off, you can just wrap tape around its back end and start throwing it immediately. Ignore any circus knives that have attached handles or hilts or are less than nine inches long, which is probably most of them. You want a big, flat, naked hunk of metal with as many straight lines as possible. It will almost surely have a disproportionately wide front end, but that's fine. We'll balance that out with extra weight on the back end and actually use that heavy front end to our advantage. For us, it will have the practical effect of making the knife (relative to a normally shaped one) behave as if it is longer than it actually is, which is good. Some expensive circus knives have built-in weights, adjustable with screws, to vary their rate of rotation. I hope you found this book before you bought one of these insane things. If not, try to get your money back. (For the knife, that is, not the book!)

These are the best of the readily available choices, but in fact, any flat, thick, fairly straight piece of suitable metal shaped something like a knife, as long as you can put a point on it, can be converted to a throwing knife — at least one good for practice, if not necessarily as good for combat. It shouldn't be over 3 or 4 inches wide and must be narrow enough at the handle end so that it will fit your hand properly after you have actually added the handle. (I wasn't kidding about lawnmower blades and files, though the former would

Chapter One

Balancing a Knife for Throwing

23

need to be flattened out, then narrowed at one end and sharpened to a point on the other.) It is best if there are no flaws or holes, like screw holes that hold on handles, since these will lead to earlier breaking.

Stripping Down Bayonets and Swords

To build a knife that will perform at the maximum level, it is necessary to permanently remove any handles and hand guards it came with; this is what I call "stripping down." We need a durable, precisely balanced handle of a specific shape for throwing, and the shape of an ordinary knife handle and guard and the materials used to make them simply are not suitable. While, as said above, it is possible to rebalance a largish knife of almost any kind to throw spear style simply by doing nothing more than wrapping tape right around the back end of its existing handle, it is not recommended that you do so while you are learning to throw. For a variety of reasons these knives are harder for beginners to control than stripped-down bayonet and sword blades. You will quickly break, dull, and otherwise damage them if you throw them in this fashion, and if you leave them sharpened you will jeopardize your life, so why bother?

Cheap swords of the kind we want usually have a partial tang, which means only the length of the knife above the hilt is useful. This makes things simple. Just cut the handle off right above the hand guard and discard it. The leftover blade will make at least one good throwing knife, or two smaller ones if you cut it in half. You can use a hacksaw or a cutting wheel on a rotary tool for cutting. Be aware that you won't have to cut quite all the way through. At a certain point you can just put

Combat Knife Throwing
A New Approach to Knife Throwing and Knife Fighting

24

the sword into a vise and whack it with a hammer next to the cut, and it will break. This saves a little time and wear and tear on your tools — although I suppose the hammer and vise might say different.

Bayonets of the preferred kind are a little more complicated. As already described, they have a wooden handle attached to the tang with screws. Unfortunately these, being about a century old, are often rusted too badly to turn with a screwdriver, but you can pry the whole handle off with that same screwdriver and the help of your hammer. This will reveal a full tang shaped like the handle, with two screw-holes in it (you might now have to cut off the screws). The mechanism that attaches the bayonet to the gun (the heavy piece of metal on the very back end, with the retracting button) and the piece located where a guard would be on an ordinary knife (it has a hole in it for the gun barrel to pass through) must both go. The former you must remove by cutting; the latter you can often just knock off with a hammer, although it is lightly welded on and may bend before it comes off. Aside from the necessity of rebalancing the knife and making it fit comfortably in the hand, the weight of these things will cause a knife to break much sooner.

The decision you have to make is how much of the blade you want to use. If you want the longest knife possible, you can file or grind down the irregular edges on the tang and use the whole piece, though the knife may sooner or later break at one of the screw-holes. For a knife a couple of inches shorter, one that won't break as quickly, you can cut the knife off at the front screw-hole. Shorter knives usually have a much longer life span than bigger ones in any case, but then again, if you get at all lucky with the location of a break in a big knife, it will still make a good short knife or possibly even two. Of course, you could save the most time and effort simply by

Chapter One
Balancing a Knife for Throwing

25

treating the bayonet the way you would a sword and just remove the whole handle with one cut, but this will make a knife 3 or 4 inches shorter, which will make for a big difference in its performance.

The size of the knife used to throw is a matter of personal preference; there are no absolute answers about what is best for a beginner to learn with. You must determine your own physical and mental strengths and weaknesses, and until you know what you are doing you should always err on the side of safety. There are distinct tradeoffs between bigger and smaller knives. The one that will interest you most at this point is that bigger knives seem to be far easier for most people to learn to throw, but smaller knives are easier to acquire and overall might be a little safer.

I usually call knives greater than 16" in length "big knives," knives less than one foot in length "little knives" — or my pet diminutive, "baby blades" — and those in between "two-way" knives. While the exact lengths chosen here are a little arbitrary (it's a more gradual change), knives definitely do fall into three major categories in terms of their behavior when thrown. Big knives can be thrown from greater range and this makes it less likely that a big knife will bounce back far enough to hit the person who threw it when he misses, but if they do, they do correspondingly more damage.

A beginner shouldn't practice throwing really big knives from inside 8 or 10 feet. A two-foot sword blade that glances back at your head from close range could kill you. (We will call knives coming back at where they came from "glance-backs;" this phenomenon deserves a name because it is mortally important to understand.) Big knives can be thrown underhand more effectively from any range, and in either of the underhand styles we will introduce. Big knives hit hard of

Combat Knife Throwing
A New Approach to Knife Throwing and Knife Fighting

26

their own weight and so don't need to be thrown at maximum speed to be effective, which also can make for a slower, easier to understand throwing motion. However, since their greater momentum can keep them moving even after they stick into targets, it can be a little harder to tell from the angles that they stick in at what you are doing wrong and so correct it.

Little knives need to be thrown at greater velocities for effectiveness, and when they glance back at the thrower they come fast, but are much more accurate than larger knives. They are difficult to throw underhanded except from close range; inside 8 feet or so.

Two-way knives perform well for any of the five basic throws (four combat throws and one mostly recreational throw) described in this book, but aren't the best knife for any of those throws individually.

You will have to experiment a little to find what size knife works best for you. If you have a larger knife, remember: You can always make it smaller, but if you make it too small to begin with, you won't be able to make it large again. The biggest knives, because they are hard to carry or conceal, are primarily used for practice and some other fun stuff to be discussed later; the smallest knives probably need to move a little too fast when thrown to allow beginners to understand the basic mechanics of this style of knife throwing. We will therefore start by assuming the use of a stripped-down bayonet or sword blade between 12 and 16 inches long, since these are generally the best combat knives, and this book is largely about combat-style throwing. Keep in mind, however, that unless otherwise specified, the instructions apply equally to all sizes and shapes of knives — it's just that particular throws can be considerably easier or harder, according to the knife that is used.

Once you have a naked blade of any kind, dull its edge with a file or whetstone if you haven't already figured this out the

Chapter One
Balancing a Knife for Throwing

27

hard way during the stripping-down stage. Sharp knives are dangerous to work with when stripping down, but crazy dangerous to learn to throw with. You want to make the handle end especially dull, since this will prolong the life of the tape handle we are to make. It is also important to make sure the point isn't too dull or too sharp.

If you're using a bayonet blade of the kind with only one sharp edge and an opposite edge that is thick right to the end of the point, you'll want to put at least a false edge on this thick side, using your file or grinder. (If you are really serious about knife throwing you might want to invest in a grinder, because anything you have to file takes a lot of effort. A rotary tool beats a hacksaw, too.) You'll know a knifepoint is too sharp if it bends in any way when you take it out of a target. If you don't dull it, it will eventually break. Cut a new point that isn't at such an acute angle.

Incidentally, any time you put a new point onto a knife it should be a wedge point, because this keeps a little more weight on the knife (when thrown, knives with dagger points act as if they are an inch shorter than ones with wedge points). Also, you only have to make one cut, not two, as you would with a point in the center of the blade. Always cut the blade side off if the knife has one thick edge and one bladed edge; if you do the opposite you're making a drop-point. If a knife won't stick into anything, this could be an indication that the point is too dull. The general rule about points is this: the smaller the knife, the sharper the point. This is because heavier knives bring their own power and therefore don't need as much help to stick in.

Next you will want to give your knife a coat of paint. Paint will help keep your knives from rusting; this is necessary if you throw outdoors. You will be repainting them often — of course the paint will chip off gradually when you throw them

Combat Knife Throwing

A New Approach to Knife Throwing and Knife Fighting

28

and it will wear from the point immediately. For this reason you should just use cheap spray-paint, not expensive rustproof or aluminum paints (although the latter makes a good primer). The best colors are the brightest, for a couple of reasons. First, when you throw knives outdoors you lose them. A knife painted fluorescent orange or yellow is much easier to find when it snakes its way under the grass than one painted black.

Does a hot pink throwing knife offend your aesthetic sensibilities, cowboy? I don't blame you; it does mine also, but consider something else. A bayonet blade left unpainted or painted black or dull rustproof red with black electrical tape wrapped around one end, a knife clearly much used and scarred by many throws, looks a great deal like something from the book *Improvised Weapons in American Prisons*. It looks like a "shiv." It looks like something you'd see lying on the floorboards of Charles Manson's dune buggy. It looks dangerous enough to jump up and bite someone of its own volition. It looks bad, and that ain't good. What's that nice girl you invited over for dinner going to think when you forget to put your blades away and leave these monstrosities in plain sight? What's that police officer who pulled you over for speeding or stopped you on the street going to do if he finds them on you? Will your parole officer be amused by all this?

It is here that a happy color scheme, such as the sort used in children's bedrooms, can come to your rescue — along with the justifiably benign reputation circus performers give knife throwing. Pleasantly admit that it is a throwing knife, that that's your hobby. After all, who outside of Hollywood ever heard of using a throwing knife in a fight? If necessary, explain the mechanics of circus throwing and its uselessness, to show what a harmless hobby this really is. Don't explain spear-style throwing; they don't need to hear about that. A nice demonstration of juggling also seems to make these

Chapter One

Balancing a Knife for Throwing

29

deadly weapons seem more like toys. You might even want to whistle a tune as you give them one.

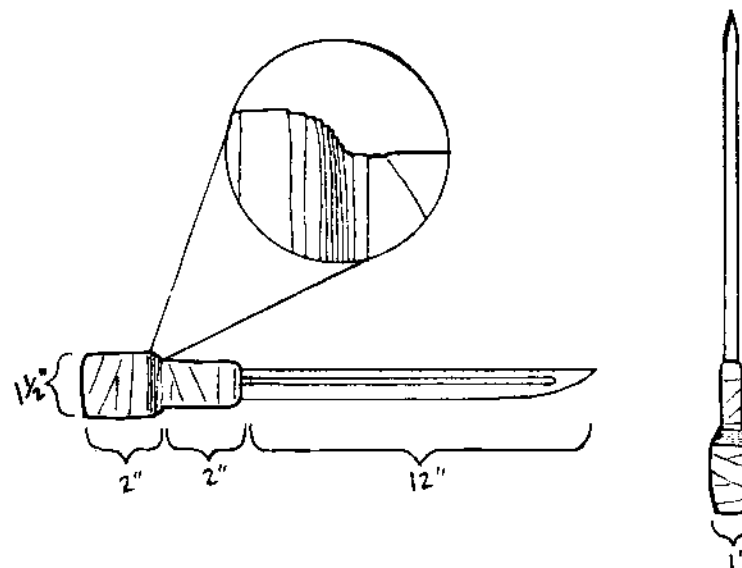

Figure 5

Here are some good rough dimensions for a 16-inch Mauser bayonet blade with a wedge (clip) point. Notice that by gradually making the handle thicker towards the back end, as shown in the insert, you can make an "underhand cuff" that you can comfortably wrap the end of your middle finger around when the knife is held in the underhand grip (Chapter 3).

Before making the handle, it is a good idea to put a strip or two of tougher tape, such as sealing tape, right over the edge of the part of the blade where the handle will go, just to dull it

Combat Knife Throwing
A New Approach to Knife Throwing and Knife Fighting

30

even further. The force of the knife leaving your hand will cause a tape handle to move slightly against the blade and, over many throws, actually begin to split even many layers of tape. Dulling the blade beneath the handle slows this process down. To make the tape handle itself, just start wrapping tape around the handle end of the blade. Whatever kind of tape you use, it needs to be dense and tough. Paper tape like masking tape or freezer tape won't work. Scotch tape won't work. Good quality duct tape or cloth tape work just fine, but if either is used for the outer layer they will leave annoying little strings hanging out before long. The best is electrical tape or any other of heavy plastic tape. Don't get the cheapest kind or the most expensive kind; the former will come unglued and the latter isn't necessary. Colored electrical tape is usually more expensive, so save it for the outer layer only and use regular old black for the rest. Don't stretch the tape too tightly or wrap it under hot temperatures; this will cause its shape to distort overnight as it contracts. It will "telescope" and hang over the back end of the knife. If it does so, you will need to cut this excess off and wrap it again, as there will then not be enough weight on the back end for the knife to fly properly.

The shape, size, and weight of the handle are vital; study the illustrations. The handle's weight will vary proportionately to the weight of the knife, but this is not as true of its length. A handle always needs to be at least long enough to hold your whole hand when you grip it, so it will still be usable as a hand weapon, and to make it easier to handle in general. Thus, an 18-inch-overall blade might need 5 inches of its back end covered in tape as a handle, but a blade only 12 inches long might need a handle very nearly as long. Practically, this just means that longer knives will have much thicker handles.

Regardless of the handle's length or the knife's overall length, more tape is always wrapped around the butt end of the

Chapter One
Balancing a Knife for Throwing

31

knife handle. (This back area of thicker tape will extend from the butt to about one and one-half inches up the handle on a 12-inch-overall blade, or about 2 inches from the butt of the handle on a 16-inch-overall blade. This back one and one-half inches of the handle is about three-quarters of an inch thick on a 12-inch-overall blade; the corresponding 2-inch long area on a 16-inch-overall blade is about one inch thick. The front couple of inches of the handle of either is about half as thick as its back end.)

This is one of two simple secrets to making the knife behave the way we want. The other is the "underhand cuff." Notice the area where the thicker amount of tape on the back part of the handle meets the remainder of the handle. Obviously, this point of meeting creates a little drop-off, a stair-step; this is what we call the "underhand cuff." By deliberately telescoping the shape of the tape here as you wrap it to make this a gradual step-down, and by locating it to exactly mate with a certain spot just below the top knuckle on the palm side of the middle finger of your throwing hand, you can make this area fit perfectly into your hand for underhanded throws. The cuff will give you better velocity, range, and control when throwing underhand. The thicker tape wrapped around the whole back end is simply to give it weight enough to counterbalance the remainder of the knife blade so that it can be thrown spear style from any arm angle. It also has the effect of adding far more punching power to your throws than any ordinary knife has, and the handle as a whole acts as a shock absorber, making breakage less likely.

Getting the blade perfectly balanced is the hardest part; it usually requires repeated experimentation (by throwing and rewinding) until it feels perfect. Even a few inches of tape, wrapped in the right or wrong spot, can dramatically affect the performance of smaller knives. The ideal balance point of a

Combat Knife Throwing
A New Approach to Knife Throwing and Knife Fighting

32

knife meant to be thrown spear style is, for knives from 12 to 16 inches, usually around two-thirds down from the point (right about where the front end of the tape handle is). To find the balance point of your knife, simply hold your hand out palm side up and lay the blade on your extended index finger, then see at what point on the blade the knife will sit there without tipping over one way or the other. Adjust this by adding or subtracting the amount of tape on the handle.

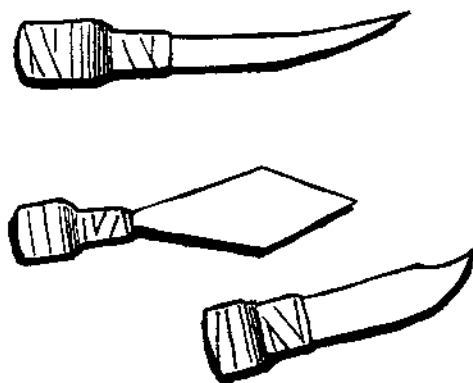

Figure 6

You can make a throwing knife out of almost anything; all you have to do to balance it properly is experiment with the shape and thickness of the tape handle. Here are some suggested shapes for a short sword blade, a big circus-style throwing knife, and a Bowie knife blade.

You are going to need to learn to throw before you can balance a knife properly, but you need a properly balanced knife to learn to throw. Is this the all-time Catch-22 or what? I guess you're going to have to do a lot of skipping back and forth be-

Chapter One
Balancing a Knife for Throwing

33

tween chapters in this book. And here I was trying so hard to keep it nice and linear.

With all this understood, here are some general pointers in balancing a knife: first, if the knifepoint is dipping and wanting to rotate, you probably need more weight on the back. Too much weight on the back will cause the knife point to want to jump up instead of fall down, so either take some off the back end or make the handle a little longer and heavier on the front end. Either of these phenomena can also result not just in the knife hitting with the point off its desired horizontal line, but in the plane of the blade itself becoming destabilized in flight. A poorly balanced knife will thus tend to hit the target flat or at unpredictable angles.

If knives are hitting point-first and bouncing off targets, you might have one of a number of problems. The handle might be fairly well balanced, but overall just a little too heavy for the size of the knife (which would also reduce its range). The point of the knife might be too dull. The target might be unusually hard due to dry or cold weather. The target might be made of a wood too hard for the grade of metal of your knife to penetrate consistently. You might not be throwing hard enough. Everything about the whole system influences everything else and conditions vary, which is one reason why it is so important to be able to balance and rebalance your own knives. Another is the fact that your handles are going to suffer some damage. They will be cut by other knives you throw while they sit innocently stuck in targets, dented by rocks when they hit the ground, become ragged on the outside layer of tape, and they will, as mentioned, split at the front end where the blade rubs them from underneath. These kinds of things can sometimes be fixed just by wrapping a new layer of tape over the whole handle, or by removing and covering just the bad spots, but sometimes only by creating an entirely new

Combat Knife Throwing
A New Approach to Knife Throwing and Knife Fighting

34

handle. Knowing immediately what a handle needs can only be done when you reach a high level of intuitive understanding of the behavior of thrown knives. This comes only with practice, but there are exercises that we will cover later that will help to make your learning curve less steep.

Chapter Two
Targets and Safety

35

Chapter Two

Targets and Safety

Now that you have built at least a rudimentary throwing knife, you're going to need something to throw it at. I'm sure you have anticipated this. I hope you haven't been casting an eager gaze at any of the trees in your back yard. Throwing knives of this size at trees, especially in the warm months when the sap is up, will kill them very easily, which would be a most dastardly thing to do. Even leaning a board up against one will endanger a tree's life — you won't always hit the board, and unless it is very thick and you keep it in good shape, it won't be long until you are splitting it and penetrating it entirely. You're going to have to build some targets. Fortunately, this is much simpler than making a knife and all you really need is some scrap lumber and a few basic tools.

There is no reason, in spear-style throwing, to construct complicated hanging targets of the kind circus throwers seem to prefer. These are usually arbor-like metal or wooden frames holding a thick wooden backboard suspended by chains attached to the frames, with thinner target faces made of log ends or something similar attached to the backboard. Circus throwers focus on short-range accuracy to the exclusion of almost all else, and throw comparatively lightweight knives at

Combat Knife Throwing A New Approach to Knife Throwing and Knife Fighting

36

comparatively low velocities. Because of this these targets suit them well. All they have to do is change the target faces on occasion. But bayonet blades with several ounces of tape wrapped around them flying at these targets would destroy them, backboard and all, much quicker than circus knives could, necessitating much more frequent replacement. Worse, because we are going to learn to throw knives while moving in all directions or standing off-balance and from multiple arm angles, longer ranges, and so on, we won't always be so accurate as the circus throwers. Those metal pipe frames are a good way to break our longer knives on a miss. In fact, one of the worst things you can have in the area where you throw knives is big pieces of any kind of solid metal.

It is possible to make targets of softer materials like straw or hay bales, but it isn't recommended. These types of things absorb a knife too deeply with too little effort from the thrower. Even imperfect throws are accepted into the unconditionally loving embrace of such targets. This seems like a blessing in the beginning, but it doesn't help you to improve very quickly, since it is hard to tell what you could be doing better. Worst of all, it encourages lower velocity throws. These things are good only for your first days of throwing, to build your confidence, or as backstops to your real targets, which should be made of wood.

There are fundamentally three types of wooden targets: boards, poles, and logs. None is necessarily better or worse; each has its advantages and disadvantages.

Flat planks and boards are the best targets for beginners for two reasons: they have a broad surface to hit and predictable angles on glancebacks. These targets are generally the easiest to maintain and safest to throw at. The flat surface will usually knock misses down into the dirt where they can't do much harm. Their biggest drawbacks are the fact that even perfect throws will occasionally bounce off of them when the plane of

Chapter Two Targets and Safety

37

the knife blade happens to hit perpendicular to the grain of the wood, and the fact that these are the shortest-lived of targets. Larger knives will split, splinter and otherwise chew up even 2-x-4s in relatively short order. There are a couple of other problems with these targets. One, if you throw at them at an angle sideways to the board, you risk breaking the point of the knife. If the knife sticks in, the force of the throw can carry the blade onward sideways across the target, snapping off the point and leaving it behind. (While we're on the subject, this is why you should always remove a knife stuck in hard from a target by moving it up and down with the plane of the blade, not sideways to the plane of the blade — if you do the latter, you'll bend or break it.) Also, you have to make sure that boards are firmly attached to some kind of background that is either very heavy or set into the ground. If they are not, they will have a trampoline effect on the knives, causing them to bounce off more often and less predictably.

Different types of woods give different results for all targets. Plywood, chipboard, Masonite, and such composite materials are nearly useless, because they have a lifespan measured in seconds when you throw knives at them. Likewise, wood that is starting to rot is useless; to a knife thrower it is sawdust waiting to happen. Planks made of soft deciduous wood like poplar are usually cheap and can have the great advantage of not easily splitting, because knives tend to almost punch holes in them and this absorbs the energy of the knife strike instead of distributing it through more of the board, which is what causes cracking. However, the surface of these boards will, as a result, become pitted with holes, and this irregular surface will reject more knives. Brittle woods have the opposite effect; they shatter on impact. The heavy types of oak that are used in construction are great for board targets. They splinter after a while, but only on the surface of the board, and these splinters can be peeled off. The core seems to almost last

Combat Knife Throwing A New Approach to Knife Throwing and Knife Fighting

38

forever. Red cedar works well for all types of targets since it is soft yet firm, resistant to rot and insects, smells wonderful when you cut it, and is plentiful and cheap in every area where it is found. It cannot be beat.

The easiest way to make a board target is to simply nail one tightly at the top and bottom to an already existing post or other background of some kind, such as the wall of a barn or outbuilding (be forewarned that these knives will go through sheet metal of the kind tin roofs or prefabricated storage buildings are made of as if it were aluminum foil if they hit it with the point, even when they only bounce into it). You will probably want to put boards at least 2" thick up first as a base to protect the background, then attach thinner planks to these as targets. Use nails with the smallest heads possible and locate the nails in places where you don't intend to throw (usually as high and low as can be). When a knife meets a nail head the knife wins easily, but enough of this punishment will of course dull and weaken your points.

If you don't have an existing backdrop to nail a target to, make one yourself. Get a solid post about 7 feet long — the best commonly available in the eastern U.S. are locust and our buddy red cedar, since they last the longest when exposed to the elements — dig a shallow (1 foot) posthole, and put it in the ground. Don't bother to tamp dirt too tightly around a post you use for knife throwing; you may find you have to move it when knives start flying in unpredictable directions and glancing into things you didn't expect them to, and in any event, no post will last forever.

And, of course, unless nothing else is available, it is silly to use treated lumbers or any kind of post you can use for something else as knife targets. You want the worst grade of scrap lumber you can find, a post you cut yourself somewhere from a fallen tree, old used nails and such, for after you are finished

Chapter Two Targets and Safety

39

you will return mightily armed, and you will come not to build but to destroy.

It may seem simpler, if you are going to have to put a post in the ground anyway, to just go ahead and use the post itself for the target, and indeed it can be — but there are some problems. Unless it is thick and durable, the post will soon wear out and then you will have to put in a whole new post. If you were using planks attached to the post, you would only have to replace the plank, which is quicker and easier. Of course, with round posts you don't have to worry about always standing at a perpendicular angle to the target face; you can throw from 360 degrees around it. This roundness is the advantage of the pole target, but it also brings a big disadvantage. Round posts will send knives straight back at the thrower far more than any other type of target. This is because, unless you hit the post dead center, the point will turn slightly sideways on impact simply due to the curvature of the post itself. This can, on occasion, knock the blade of the knife hard into the post and bounce the knife straight back towards the thrower. Unless you are very confident in your accuracy (or your ability to duck!) or plan on not practicing any close-range throws involving moving towards the target — that is, many combat throws, the main thrust of this book — when you start out you should only throw at pole targets if they are at least a foot and a half wide, and where are you going to come up with a post that big, let alone get it into the ground? A big dead tree is the only realistic type of pole target for a beginner. We might use small pole targets much later, to learn about defense against the knife, but you have to live long enough to get that far first.

By far the easiest wooden target face to stick a knife into is the end of a log. This is because it is much easier to stick a knife into wood when the plane of the knife blade and the grain of the wood are going in the same direction, and with a log end this is always true because you are throwing *into* the

Combat Knife Throwing A New Approach to Knife Throwing and Knife Fighting

40

grain itself, never against it. However, wood grain is not as big a problem with our style of throwing as with circus throwing. Partly this is because of the penetrating ability of our heavier knives, and partly because we can fairly easily keep the blade plane vertical anyway, which of course matches the grain of a post or plank that is standing up (by the way, if you have a large background such as a barn wall that you attach planks to as throwing targets, always do so with their grain vertical and not horizontal for this very reason). Nevertheless, log ends made of practically any wood are yielding but firm compared to a plank or post; and since they are also flat this makes them the ultimate surface to throw knives at.

The problem is the fact that you need logs from large trees, because cordwood-size is just too small for a target face. Unfortunately, as already mentioned, unless they are cut very thick, the knives we use would quickly destroy mere slices of wood, making frames for hanging them just about useless, and it is difficult to find ways to set larger hunks of logs up onto something that will hold them up high enough to throw at.

My solution is to simply stack logs about 6 feet long and a foot or two in diameter up on top of each other into a pyramid (these constitute two of my 30 or so knife targets). This allows you to throw at either end of your log pile, which cuts in half the wear either side would take, and if a target face becomes too rough, you just saw it off to make another one. Such targets will clearly outlast anything else many times over; if they don't rot they should last at least several years, and so might justify the effort it would take in getting them. If you use something like this, you might want to resist the temptation to throw at the sides of the logs instead of the ends. If you hit the top edge of the top log the same thing can happen as happens with round pole targets, only this time the knife will often fly straight up in the air, and where it stops, nobody knows.

Chapter Two Targets and Safety

41

If you have a barn, garage, or similar structure, one with plenty of space and interior walls that are hard for knives to damage, you have the perfect place to throw knives. You can quickly erect multiple targets, the walls keep the knives where you can easily find them when you miss, and of course, you're out of the elements. Consider yourself lucky, as I do (not having a garage, I have converted a small barn of mine into a "chop shop" of a different order). But if you do have to throw outside, *don't* consider yourself *unlucky*. As long as you do a couple of commonsense things, in good weather it's always more fun to throw outdoors, and anyway, the light is better.

Throwing knives have a perverse disposition when dealing with beginners. Aside from never going quite where you aim them, they deliberately find ways to get lost. When you take them outside they behave like children at recess. They will crawl under leaves, slither under grass, and sometimes, when they are in a particularly impish mood, find ways to hide above ground level, like in some grapevines or the crotch of a tree. They even have the power to make themselves temporarily invisible; you will find them suddenly reappearing in an area where you are sure you had already looked. If you are stumped, start at the target you threw at or the spot you think the knife most likely to be, and carefully work your way around it in a spiral. Sooner or later you will find the knife; in nearly twenty years and tens of thousands of throws, I have only once lost one longer than overnight. You did take my advice about bright paint, didn't you? Here's some more advice: Keep your grass trimmed short around your throwing area, use a garden rake to scour the dirt itself if that didn't work, invest in a good leaf rake if there are trees in your yard, and maybe a metal detector if you just get obsessive about it. A perfect knife can be a hard thing to part with.

Actually, you can make losing knives a very rare event, even outdoors, if you have sufficient backstops. In hilly areas,

Combat Knife Throwing A New Approach to Knife Throwing and Knife Fighting

42

just standing in a valley and throwing towards the side of a hill will help greatly. Backstops can be made of anything you don't mind having a knife hit; they are really just improvised walls or fences. Scrap tin or hexagonal woven wire nailed to a couple of posts acting as supports can work well, as do stacks of firewood. Backstops are best if they are constructed in a V-shape, where the target is located on the inside of the point of the V. They need to be touching the ground without leaving any gap, stand higher than the target itself, and should extend at least three feet on each side even for short-range throwing.

Backstops also help to protect any spectators, though the best way to do this is to simply not have any. Unless you are doing simple stand-still throwing at close range, like the circus throwers do, this style of knife throwing is just too dangerous to have anyone standing around watching. Our knives are bigger and meaner and hit harder than circus knives. Knives glancing off targets can fly 20 or 30 feet through the air in unpredictable directions, and if someone isn't paying attention they could get hit. Little boys are especially hard to deal with. They seem to be invariably fascinated with a man throwing a knife, and invariably oblivious to the fact that just because he seems confident of his own safety doesn't mean they should feel so brashly confident of theirs. And anyway, the last thing anybody needs is a reputation as a combat-oriented knife thrower (one reason the current author is hiding behind a pen name). Advertising yourself as some kind of bad boy only leads worse boys to your doorstep to test you; and if you ever do have to use this skill, it might be better to do so in secrecy, which might be a little harder to maintain if everybody and his dog and the horse they rode in on knows it is a skill you possess. If you have visitors desperate for amusement show them some short-range, low-velocity throws and tricks like knife juggling, which you can learn in an afternoon and is covered in the final chapter.

Chapter Two Targets and Safety

43

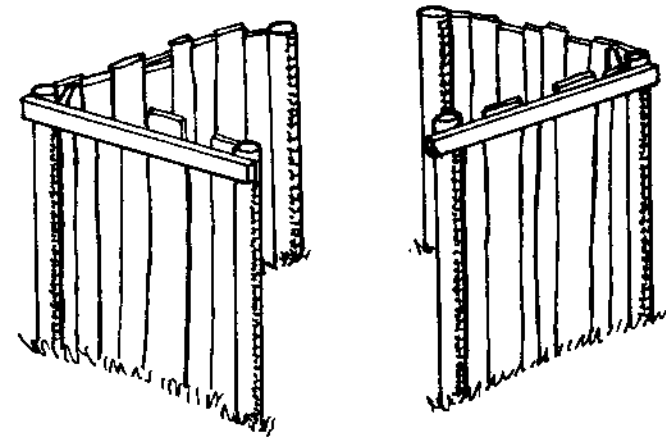

Figure 7

Two V-shaped backstops facing one another, with a target located inside each, will help you do less walking and searching for lost knives

Unless you are taking up knife throwing mostly to lose weight and therefore don't mind repeatedly retrieving your knives and then backing away from the target to throw them again, you will want to get as many knives as possible and at least two targets. This makes for less walking and more throwing since you can just go from target to target without backtracking. For real hardcore combat practice you would want a group of several poles at variable distances from each other as an outdoor practice area, but this would be a little extreme in any case and most undesirable for beginners.

The perfect outdoor setup for a beginner would be two V-shaped backstops containing board targets nailed to the inside of the post that constitutes the point of each V. The two Vs would face each other with their open sides. Each would be

Combat Knife Throwing A New Approach to Knife Throwing and Knife Fighting

44

about 12 feet deep, with a gap of 5 feet or so in between them to allow access. In a best-case scenario they would be located in an area shaded by several trees. This would make for less glare and summer heat, and in the event a blade did get away somehow, it is easier to rake leaves to find knives than it is to rake grass to find them.

Carrying Gear and Protection

If I have been making combat or spear-style knife throwing sound too dangerous for your blood (figuratively if not literally), it is time for me to assuage some of your fears. Knife throwing of this style is only as dangerous as you want to make it — if it were not, I wouldn't be here to write this book. We can make it safe by throwing safely, and we can wear things to protect us. Hockey players, baseball players, skateboarders, and of course, football players all wear so much specialized protective equipment that they look like knights in suits of armor for their games, but we don't need to go to such lengths. After all, we are only trying to survive bodily contact with sharpened pieces of flying metal, not trying to avoid getting a boo-boo when we fall down or get hit by a little round ball, like all those big, tough pro athletes.

You should always protect your eyes if you are throwing at high velocity at close range. Any point-first contact between knife and eyeball would probably blind you in that eye forever. This would of course greatly reduce your depth perception and then you couldn't throw knives nearly so well, so it is probably to be avoided. (If you haven't figured it out yet, this sort of dry sarcasm is what I have been given in place of a sense of humor.) For heaven's sake, wear goggles or something if you're getting a lot of knives back anywhere near your face. Better yet, figure out why this is happening — bad tar-

Chapter Two Targets and Safety

45

get, bad angle on throws, leaning into throws too much, whatever — and fix it. Knives should be bouncing off targets in a way that causes them to lose their kinetic energy long before they ever have a chance to get back to you with any force. In the rare event that they manage to make it that far, they should be tumbling slowly at ground level, which is why you should always wear shoes, socks and long pants when throwing knives. Your shins and ankles are the most likely places to get hit, and it stings to get whacked in the shins, as we all know. It stings worse when the shin-whacker is a knife, as some of us now know, and sometimes it bleeds.

It is also a good idea to wear some kind of protection around the throat, and possibly the wrists. This is because major blood vessels are closer to the skin surface in these areas, and if you did somehow get caught hard in either spot with a knifepoint it could be a disaster. A knife could damage your larynx even if it didn't hit with the point. You can make a collar and wristbands that will turn a knife, out of snaps or buckles and a wide piece of belt leather.

Unlike circus throwers, we don't always just stay in one place and passively toss knives at our targets in this style; we can attack them with maximum mobility and violence. Since you might be moving around so much while throwing, and will often find yourself with multiple knives in either hand, the possibility exists of tripping and falling onto a knife in such a way as to stab yourself. A knife in the throat or liver could even bring instant death if the weight of your body pressed you against the point before you could turn away. One way to protect both these areas with one garment is by getting a denim jacket with a collar, cutting the sleeves out (for greater freedom of movement), and then turning the collar up to cover your neck. You can sew an extra pad over the area of the liver (on the right side of your diaphragm, just inside the ribcage),

Combat Knife Throwing
A New Approach to Knife Throwing and Knife Fighting

46

and put a snap or button at the point of the collar to hold it up and shut while you throw.

Keeping medical tape around is another good idea. A wound that is losing a lot of blood needs to be wrapped as tightly as possible. Get the bleeding stopped if you can, and find someone else or call someone. Immediately. Your greatest danger from profuse bleeding is that you would pass out from the blood loss and then bleed to death before anyone even knew you were hurt.

Having these protective measures available will make you more confident in your safety, but this cuts two ways. Confidence will make you less hesitant, which will increase your ability to react quickly, but it could also invite your greatest enemy, which is carelessness. It only takes a split second to make a life-changing mistake. And of course you should never practice throwing knives while you are sleepy, mentally distracted, or chemically altered in any way.

The last thing we need to make is at least one sheath to hold knives. Since our knives are a little unconventional, our sheaths will need to be, too. If you don't have an old knife sheath you don't mind altering, you can get some scrap leather and make one from scratch. Just cut two pieces of the stiffest leather you can find into the shape of the blade of the knife. Since we want to let the entire tape handle stick out, only make them as long and wide as the blade part, with an inch or two extra border around their edges. Punch some holes in these borders and then sew the pieces loosely together using cord or wire. (I prefer to use copper wire stripped from old electrical cords because it is flexible but invulnerable to knife blades.) The reason the sheath is sewn together in this way is so that we can adjust its tightness to hold however many knives we want it to, as snugly as we want it to. Because these knives are without conventional handles or guards, more than one of them can be held in a single sheath. You can, of course,

Chapter Two
Targets and Safety

47

make as many sheaths as you want, put as many knives in them as you like, and locate them anywhere you want on any kind of strap; this is all a matter of personal taste. A wide waist belt of some kind, such as a military belt or a weight belt, will hold the weight of even a dozen small knives quite comfortably, and a waist belt is easier to conceal and not nearly as scary as a shoulder harness with foot-long knives in it. The last thing is to make sure that you always have at least one conventional hunting or fighting knife on your knife belt. These have a way of coming in handy in all sorts of circumstances, and it would be quite embarrassing to be caught with ten knives on you and not a single one of them much good for anything but throwing.

Chapter Three

Spear-Style

Knife Throwing

Until now it might seem that we have used the terms “spear-style” and “combat-style” throwing almost interchangeably, but there is a very significant difference. Throwing spear style, as you know by now, just means throwing in a way so that the point of the knife does not rotate, which describes four of the five throws presented in this book. The term “combat style” means throwing in a way that is intended to be used in self-defense. Practicing most combat throws therefore involves some risk to the thrower, since they are often thrown at high velocity while moving, standing off-balance, at unpredictable angles, and so on. While it seems clear that the best combat throws, for reasons discussed in the introduction, must be spear-style throws, this certainly doesn’t mean that all spear-style throwing is combat oriented.

Spear-style knife throwing can be a perfectly safe, harmless backyard recreation, in the same way that circus-style throwing or horseshoes is. And contrary to the impression I might have given, I have nothing whatsoever against circus throwing or circus throwers in and of themselves; I am probably more impressed than anyone by the phenomenal accuracy that professional performers evidently display in their acts. (For the

Combat Knife Throwing
A New Approach to Knife Throwing and Knife Fighting

50

record, I haven't seen any professional throwers live, and aside from my own experience and observations, I rely mostly on *Knife Throwing: A Practical Guide* by Harry McEvoy [Tokyo: Charles E. Tuttle, 1987] for my understanding of circus throwing. The few other books and articles I have seen are either very basic or nearly incomprehensible.) I know as well as anyone how hard it is, throwing overhand at least, to get a knife to stick consistently when you have to get it to rotate just once, let alone two or three times as many circus-style throwers can (that's why I don't bother to let the knife turn over at all). Some tricks that professionals do, such as cutting cigarettes from people's mouths, might be possible only with the rotating circus-style of throwing. The entertainment value of circus-style throwing is a proven quantity. Many people who are likely to pick this book up have probably devoted countless hours to learning to throw knives circus style. To them I offer a salute, and for a change I'm not being facetious. They have far more patience than I ever did. The short section that follows is written primarily for them, since there are things they will have to unlearn before they can learn to also throw spear style, though I daresay when they do they'll never go back.

**Comparing Circus Style
to Spear Style**

For the layman I see no advantages in circus throwing, since spear style is much easier to learn and, if you only want to keep it at the recreational level, just as safe. Of course, if you are interested in knife throwing as self-defense there is no comparison at all; spear style is infinitely superior. Circus-style throwers justifiably brag when, after weeks or months of practice, they can stick a knife eight or nine times out of ten

Chapter Three
Spear-Style Knife Throwing

51

from the usual amateur range for one rotation, about 12 feet or less; but with spear-style throwing, a good knife, and a soft target, almost any ordinary person might very well do this the first day they ever throw. (I once got a friend who had never thrown a knife in his life to stick my 18" bayonet blades into very tough, hard plank targets better than two-thirds of the time, from a range of at least 10 feet, within his first hour of practice.) Circus-style throwing can certainly be very accurate, but I see no reason why spear throwing couldn't be just as accurate, if accuracy were the sole thing emphasized. From 12 feet I can be consistently accurate, on average, to within about 2 inches with small knives, but for reasons that I will soon make obvious, I have never concentrated on pinpoint accuracy.

One way of expressing the essential difference between circus-style and spear-style throwing is to say that in the former you try to make every throw as similar as possible and in the latter you can and should treat every throw differently. Circus throwers try to throw the same knife, from the same distance, with the same release and the same stance so that they can get a perfect rotation and consistently stick the target. Since merely sticking the target is so easy when throwing spear style that it quickly becomes almost automatic, in spear-style throwing you can effortlessly switch between differently shaped and sized knives (I have two dozen and no two are identical), change release points, velocities, stances, and arm angles in a split second, throw off the wrong foot with a bad grip, throw while moving in any direction, and so on. You can, in other words, make it up as you go along. It's a little like the difference between practicing shooting free throws and actually playing basketball, or the difference between what a baseball pitcher does and what his shortstop does. Circus-style throwing is a *game of dexterity* that requires a single, very specific

Combat Knife Throwing

A New Approach to Knife Throwing and Knife Fighting

52

skill; in this it is much like bowling or billiards. Spear-style throwing can be like this if you want to stand still and throw for accuracy alone, but it can also become a *freestyle sport*, more like martial arts or skateboarding than like circus throwing. And, of course, it can be used for self-defense.

There are also some very specific technical differences between spear-style and circus-style throwing. The preferred stances, grips, and releases, as we will shortly see in greater detail, are sometimes diametrically opposed. Circus throwers just wrap all their five fingers around the knife like you would grab a hatchet; in spear style you will always use much more specialized grips, where the thumb and little finger hardly touch the knife on release. Circus throwers can throw by the blade or throw a knife with the plane of the blade horizontal; in spear style the handle is always gripped, with the plane of the blade held vertically (though this doesn't mean that the blade plane has to impact the target vertically). With circus throwing you are taught not to flip the wrist as the knife leaves the hand, or to flip it in a very feathery and consistent way, so that you won't cause the knife to rotate too quickly. In spear style we can deliberately flip the wrist hard to give the knife extra power, and the angle of the wrist and amount of flip change for every throw, depending on the range and how much of that power you want. And since they are not concerned as much with knife fighting or glancebacks, circus throwers can lean far forward into their throws or use lazy windups and predictable stances. A spear-style thrower can only afford these if he never intends to take advantage of spear style's greatest strength, which is mobile, freestyle throws, in which case he almost might as well be throwing circus style anyway. If you're going to just try to stick knives in things as an amusement, you might as well make it a challenge, which it won't be for long if you throw spear style.

Chapter Three

Spear-Style Knife Throwing

53

Spear Throws

To grip a knife to throw it spear style, hold the plane of the blade vertically in your hand with the cutting edge downwards, just as you would normally hold a knife for cutting, then place the tip of your index finger on the top edge of the blade. Please note that since your knives might change sizes but you can't change the size of your hand, on a small knife the index finger will be touching the metal edge of the heavy side of the blade (assuming it has one heavier side), but on a bigger knife this will be covered by the tape handle. This, of course, is just because our bigger knives have handles that extend a little farther up the blade. This fact makes no practical difference at all. You should wrap your middle and ring finger lightly around the knife handle. The middle finger will sit just above the "underhand cuff" area we made. The thumb should be lifted off the knife entirely upon release of the knife, but it will sit on the flat side of the handle until then to help hold the knife in place. The little finger will fit under the back end of the handle, doing little but giving the knife handle a little something to sit on when you point the knife at the sky while drawing it back to throw.

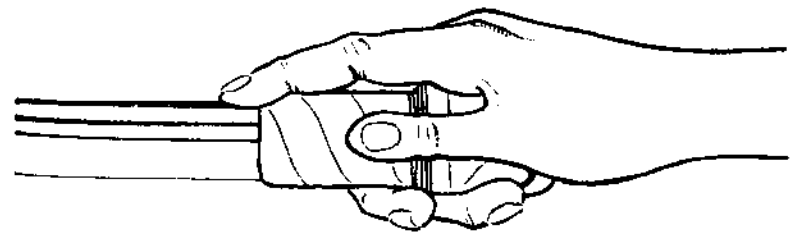

Figure 8
The overhand grip (side view).

Combat Knife Throwing
A New Approach to Knife Throwing and Knife Fighting

54

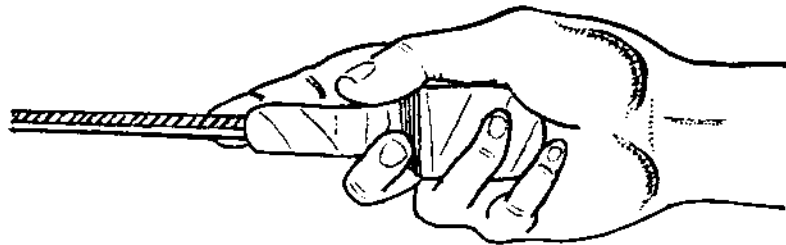

Figure 9
The overhand grip (palm view).

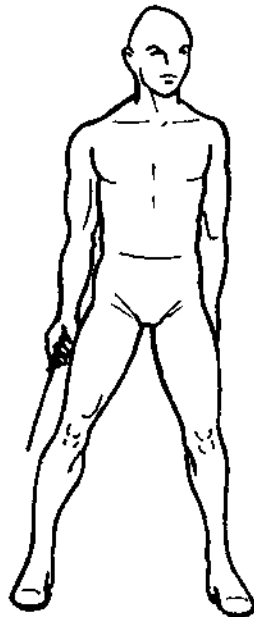

Figure 10
To throw the beginner's overhand, stand with your shoulders at a 90-degree angle to the target...

Chapter Three
Spear-Style Knife Throwing

55

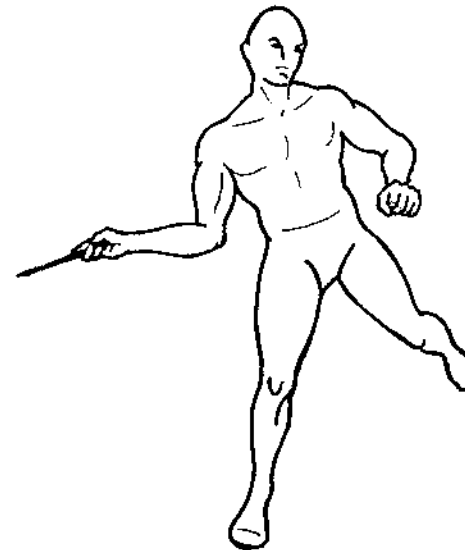

Figure 11
...plant your back foot as you rock back to gain momentum...

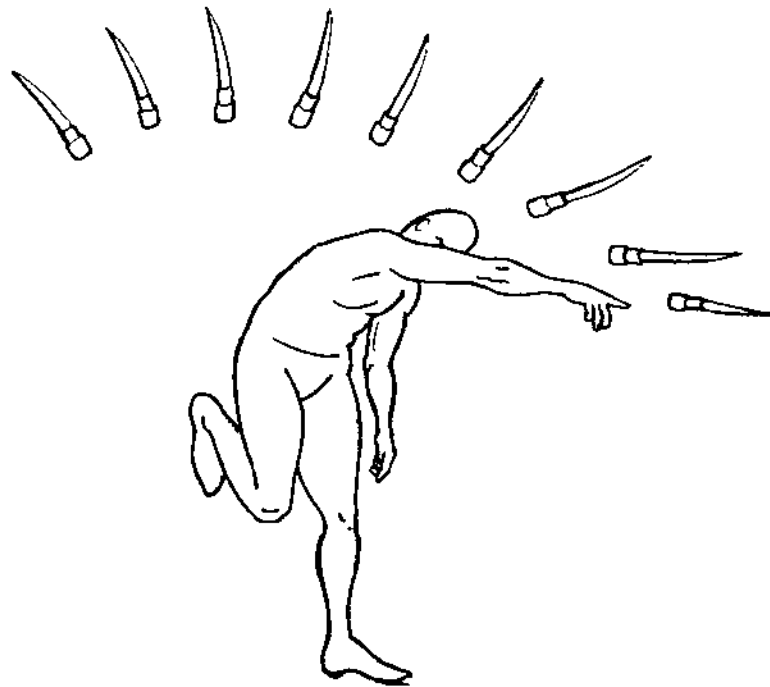

Figure 12

...and bring the knife high over your head, releasing it as you plant your front foot.

The first throw to learn is the overhand. Throw the knife the same way you would a baseball, only perhaps with more of a chopping-downwards action. You should start by aiming at about 3 feet off the ground on a vertical board target. This is not only an easier throw for a beginner to control and generate power for, but it is much safer, because the knife is angling downwards and should bounce low if you miss. (In fact, a good way to learn to do this throw, if you are having trouble, is to simply throw the knife directly into the ground, which is a nice soft target with quite a lot of area to hit.)

As you pull the knife back to throw, let your wrist fall back limply; and as you release it, propel the knife forward simply by gently flipping your wrist forward and aiming and pushing it with your index finger, which is the primary control finger in this grip. If you don't flip the knife slightly it will fly pointing upwards and hit the target flat, but as a beginner you will most likely try to flip the wrist far too hard and cause the point to drop. Learn to let the knife do most of the work of sticking in. Big knives do almost all the work for a beginner; this is why they are easier to learn with. By now it should go without saying that you are trying to throw the knife in a straight line towards the target (although in this case a line pointing at a slightly downwards diagonal angle) without the point going in any direction but forward, although for a beginner the flight will likely have some arc to it. With a little practice and a knife that has been properly balanced, a beginner should be able to stand at least 6 or 8 feet away and stick the knife into a target, which is all you are trying to do for now. This grip doesn't really need much fine-tuning; it works well even if you have gloves on. It should quickly seem natural.

Your stance for this throw is the same basic one human beings have been using for thousands of years for throwing spears, balls, rocks, or anything else that requires an overhand motion with some velocity. Watch a baseball pitcher if you aren't familiar with it. This stance varies slightly from individual to individual, according to their abilities, but some elements of good form are always present. If you are right handed (which will be assumed throughout these instructions unless stated otherwise), your left shoulder and foot are nearer to the target than the right ones, to a greater or lesser degree according to arm strength and the amount of torque that can be generated by the hips and abdomen.

When learning the overhand knife throw, you will likely want to stand nearly at an exact right angle to the target face.

Combat Knife Throwing

A New Approach to Knife Throwing and Knife Fighting

58

Lift your left foot a little with your right foot planted, rock backwards on the right foot, then swing your arm in a high overhand motion towards the target (maybe coming at an arm angle from around one o'clock) as you also step forward toward the target. You will plant your left foot just before releasing the knife at the end of the motion. Following through will help the throw, but will also keep you moving face-first into a target you just threw a knife at, which will be bad news on a glanceback. This is why you might use heavy cardboard boxes, a bale of hay, or something similar during your early training. If you have trouble sticking the knife at first, don't get discouraged — pay attention to the ways that the knife is deviating from the desired line and if you can't fix them by throwing differently, rebalance the knife until you start getting it right. I told you you'd be skipping back and forth in this book.

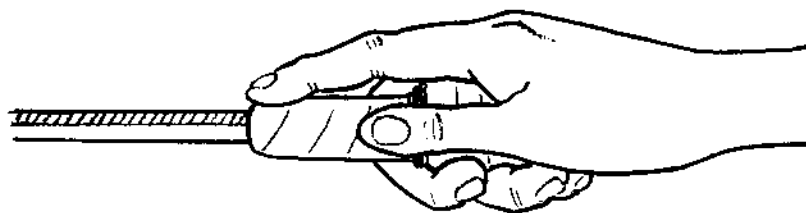

Figure 13
The underhand grip (side view).

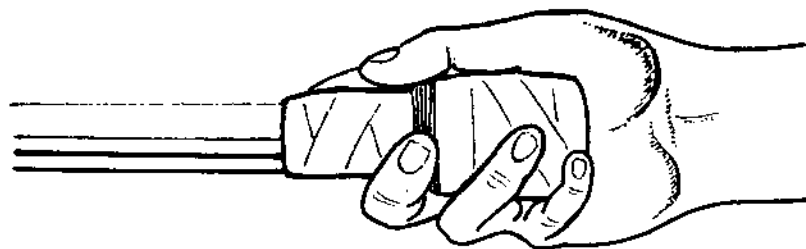

Figure 14
The underhand grip (palm view).

Chapter Three

Spear-Style Knife Throwing

59

The underhand grip is not as natural-seeming at first, but the first throw we use it for (the uppercut) seems to be the most natural and easiest of all for a beginner to learn if he uses knives that are large enough. The underhand grip is almost the same as the overhand grip; the only difference is that the plane of the blade is flipped. All you really have to do to switch to the underhand grip is rotate the knife handle by 90 degrees as it sits in the overhand grip, or a quarter-turn in the hand. To do this, hold the knife as you would in the overhand grip. Your index finger is sitting on the edge of the heavy or curved side — if it has one — of the knife blade or the top edge of the handle on a bigger knife. Right? Now, just grab the knife by the blade and twist it a quarter-turn counterclockwise (for a righty) so that your index finger is now on the flat side of the blade or handle, and your thumb is now sitting on the edge side of the handle. You'll notice that the heavy or curved side of the knife is now on the bottom and the sharp edge facing skywards if you hold the knife while extending your arm out with your wrist straight. Your middle finger is on the heavy-side edge of the handle and fits into the tape cuff we so carefully made, just below the top knuckle on the palm side as you grip the knife. This is so the knife will not slip so easily from your hand as you release it, which will give you more power and control. The middle finger is the primary guiding finger in this throw (as it seems to be among people who I see trying to help direct me through busy traffic from their driver's seats). Congratulations — you have learned the underhand grip, and the fact that we can shift to it from the overhand grip so easily makes our life much easier in combat practice.

Combat Knife Throwing
A New Approach to Knife Throwing and Knife Fighting

60



Figure 15

In the underhand stance you turn your shoulders at about 45 degrees to the target.

Chapter Three
Spear-Style Knife Throwing

61

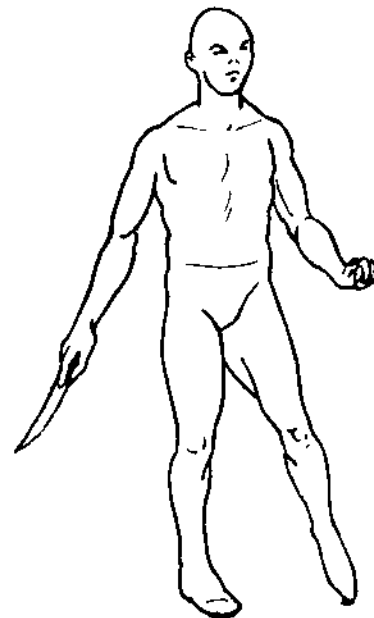

Figure 16

Rock backwards lightly...

Combat Knife Throwing
A New Approach to Knife Throwing and Knife Fighting

62

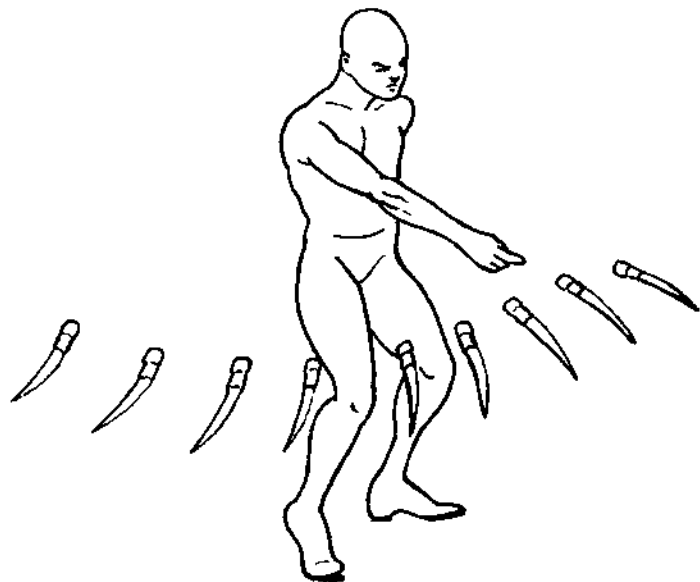

Figure 17

...then bend your knees and propel the knife forward, trying to keep your elbow and wrist straight until the knife is released.

To throw the uppercut (which is what we will call this short-range kind of underhand throw to differentiate it from the long-range underhand throw that appears in the final chapter), just stand as you would for the overhand, only with the front of your body turned more toward the target. Again, a beginner will probably need to lift his left foot at least slightly to get some momentum. You won't need to rock back on your right or plant your foot as much for this throw, because you can simply swing your arm back to generate most of the force you need, and that's really all there is to this throw — swinging your arm back and letting it rip underhanded.

To see an example of the stance used for this throw, watch a slow-pitch softball pitcher. For knives, very little if any wrist

Chapter Three
Spear-Style Knife Throwing

63

flip is ever necessary and the windup is eliminated. The point will want to jump upwards all by itself, because of the upwards hinge action of your forearm. Try to keep your elbow and wrist straight but relaxed until you release the knife to help prevent this. This throw is very difficult for beginners to get sticks with at first with knives shorter than fourteen inches, and they will need to move in closer — maybe six feet to start. This is because this throw just doesn't have the natural velocity of the overhand, which has the powerful muscles of the upper arm to propel it.

Fortunately, there is no problem in standing close because it is the safest of the throws. This throw almost never bounces back at the thrower with any speed, and even if it did, you should be in a position to easily dodge or block it. The fact that the uppercut leaves the thrower in superb defensive position after he throws is one of its great strengths. The others are the fact that you don't have to lift your arm over waist-high to throw it, making it the quickest to release of all the throws, and that for combat it gives a valuable angle of attack at close range.

As you develop more strength and confidence, your throws will naturally increase in velocity. It will very soon become possible to perform what I call the sidearm throw. This throw is made using the overhand grip. The big difference between this throw and the overhand is not so much the arm angle, which as the name suggests is lower than the more over-the-top overhand (the sidearm is thrown from about three o'clock or a little higher), but the way that you put your weight on your feet. The sidearm stance is practically identical to the underhand stance, but the primary plant foot for the sidearm is the front (left) foot, which never has to leave the ground. The left knee bends to gain momentum while the right knee will dip slightly as your weight shifts back to your right foot. Your weight then shifts forward, back to the left foot, just before the

Combat Knife Throwing A New Approach to Knife Throwing and Knife Fighting

64

knife is released. The force of this throw is generated mostly by the abdominal muscles, which turn the upper body back to the right and then quickly forward as you fling the knife at the target.

Notice that since your arm is moving nearly parallel to the ground, the most natural angle of the plane of the knife blade to fly at is now horizontal, not vertical as with the overhand. If you are throwing at targets with a vertical wood grain, you can just turn the wrist over as you throw to make the knife fly vertically if you want to stick more targets, but if you're interested in combat, you need to remember something else. The human ribs are at a horizontal angle, and it would be much easier to slip a knife between them if the plane of the knife blade was the same. And this funny little throw, released at the level of the abdomen, is the ultimate ribtickler.



Figure 18

The sidearm stance is practically identical to the underhand stance, but the grip is different.

Chapter Three Spear-Style Knife Throwing

65

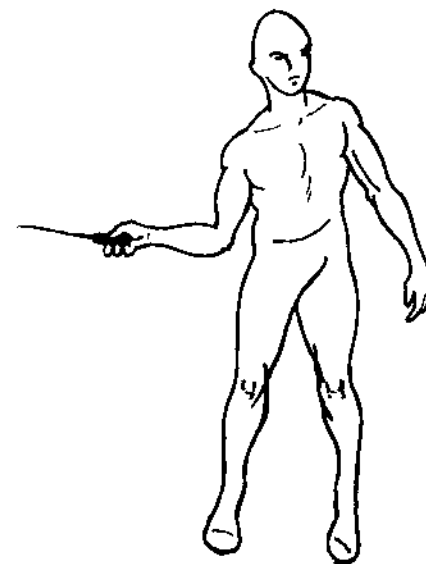

Figure 19

Momentum for the sidearm throw is generated by twisting the shoulders backwards; snap the torso and arm forward to throw the knife, in something like the way you would crack a whip.

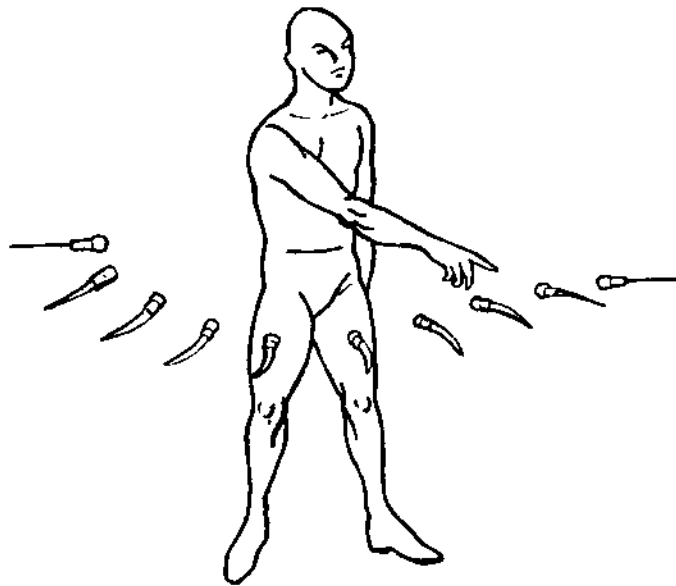

Figure 20

The arm moves in a plane almost parallel to the ground, while the feet remain in good balance throughout the throwing motion.

The final of the four combat throws is by far the most impressive to spectators and by an equal margin the least useful in a fight; it is the around-the-back or "wraparound" throw. The throw could almost be described as a cross between the overhand and the uppercut because it uses the overhand grip but comes from the same upwards-moving angle as the uppercut. This throw usually requires a good ability to flip the wrist because it is, obviously, harder to generate natural velocity throwing something around your back. The little velocity this throw has comes entirely from the hinge action of the elbow and wrist, so there really is no stance for this throw. It can be thrown as well from your knees as standing up. Its use is to either take advantage of, or avoid being taken advantage of by,

the element of surprise. Someone behind you can find a knife coming at his face from an angle he never expected if he gets too close.

We can illustrate the three major throws by concentrating on the relationships between the position of the feet to the angle of the shoulders and the motion and angle of the knife blade as it approaches the target. The feet determine the balance of the whole body. The shoulders show the angle of the torso as it turns on the waist. The motion of the knife will, in a sense, drag the arm with it.

Advanced Tips

Throwing knives spear style is intuitive, and developing greater ability comes naturally with practice, not through any amount of reading or thinking about it. Nevertheless, there are some things that, if recognized consciously, can help speed this process along.

The first of these is spin. By "spin" I mean the kind of spin a bullet, arrow, or drill bit has: rapid circular motion of its whole length. In the four combat throws, spin is bad. Spin causes a throw to lose just a little energy and therefore to not hit quite as hard. It also causes a knife to drill a hole into a target and then flip out of it. The tiny gain in accuracy it will give a throw is not enough to make up for these things. Try to make these throws spin as little as possible by not twisting your wrist or fingers as you release the knife. A throw with little spin is called a "flat" throw.

The ultimate goal regarding your knife grips is to be able to put a knife into either of the two grips so automatically that you never realize you have done it. Aside from being able to switch from overhand to underhand and back again, and maybe into a stabbing grip, you will constantly be moving

Combat Knife Throwing

A New Approach to Knife Throwing and Knife Fighting

68

knives from your off hand to your throwing hand both in front of and behind your body (see the combat chapter). The trick is to be able to grip a knife lightly enough to be able to move it around in your hand effortlessly, yet firmly enough that you don't drop it. Playing with knives all the time is the only way to achieve this.

As your throws grow stronger and your range greater, you will realize that the point at which you release the knife changes according to how hard you throw, at least if you want to stick anything. The harder you throw, the later you must release the knife. This is true for all throws. If you lob a knife softly overhand, it is possible to stick it into targets greater distances away. I have used these high-arching throws to drop even my littlest knives into targets twenty-five feet away; a long sword blade can do this from up to about forty feet. With this kind of throw you must release the knife while it is still over your head. Of course, such a throw has no velocity to speak of and therefore no practical use. To get power on a throw, you must throw it in as straight a line as possible, and on overhand and sidearm throws (the first and second most powerful throws respectively), this usually means releasing it when your arm is parallel to the ground. You won't be able to stick things from as far away doing this (range and velocity are two different things), but it will mean more when you make a hit. Of course, there are other factors that will affect how powerful your throws are. Natural ability aside, mainly it is a matter of making your throwing motion increasingly efficient by eliminating all wasted motion. This in turn helps make your balance better, and maximum balance plus no wasted motion equals maximum power.

Because in real combat, targets and throwers can both move, throwing power, *velocity*, is the main emphasis of combat throwing — not accuracy. When you are trying to be super-accurate you tend to develop tunnel vision on a single small

Chapter Three

Spear-Style Knife Throwing

69

spot on a target. In combat this is suicide; you must use your peripheral vision to track changes in your opponent's overall body language, which will give away his intentions. And even if you do hit that spot you picked out, he's not going to be there when the knife arrives. You have to be able to change the throw at the last instant as he moves, and then put the knife in a spot you didn't expect.

Developing this kind of accuracy doesn't come from stand-still practice at hitting small spots, which should constitute only a small part of your training if you turn to combat style, but from developing the kind of balance and fast reactions that will let you throw a knife reflexively from all kinds of unexpected body positions. Throwing a knife combat style with accuracy is like throwing a punch accurately, not like shooting an arrow at a bullseye. (And, like throwing punches, you should try to throw *through* things, not *at* them.) The difference, however, is that unlike throwing a punch, a knife will do massive damage wherever it makes contact with a human body; there aren't many "glancing blows" with a thrown knife. For this reason, punching power with a knife assumes the greatest importance. A knife to the face is a knife to the face, whether it hits you in the eye or merely shatters your jaw and comes out the other side of your cheek. If you were lucky enough to get your arm up, maybe it only knocked you out when it glanced off a bone and hit you in the head, instead of killing you instantly. As long as you hit something hard, it might not matter as much what exactly it was you hit.

Nevertheless, if you can't hit anything standing still, you certainly won't be able to hit anything while you're moving. You should develop adequate accuracy automatically if you throw multiple knives without removing them from the target as you throw, since you will find that you have to hit smaller and smaller spots to avoid hitting the knives already stuck in.

Combat Knife Throwing
A New Approach to Knife Throwing and Knife Fighting

70

Also, you can track the damage on your target faces to see where and by how much you are missing.

You will note that with the uppercut and overhand throws, you are much more able to hit a vertical line than you are a horizontal line. This is because the angle of your arm in making these throws is naturally almost vertical to start with, so if you release the knife a little early or a little late you still will hit your vertical line — but not your horizontal line.

The sidearm, which by definition has a natural side-to-side arm motion, does not have this problem. It is the most accurate of all throws because you almost have to hit the target where you aimed it to get the knife to stick at all. Notice, then, that both power and accuracy in spear-style throwing depend very much on the point of release of the knife and are therefore interrelated. A knife that goes straight in exactly where you aimed it hits hardest of all.

After you have mastered the point of release you need to develop a quicker release. The quick-releasing throws are the sidearm, which because of this and because it does all things well, is the prince of combat throws, and the even quicker uppercut. Developing a quick release and developing power are almost the same thing for the uppercut. Both come from an increasingly fast motion of the forearm. With the sidearm it's a little different. You can have power on this throw without necessarily having a fast release, so you need to make a conscious effort to improve. Test this by seeing how many knives you can throw and stick in a limited time frame. This will be highly influenced by the size of the knives; only with smaller knives will you be able to get off more than one or two throws in a second, and only then if you have gotten really good at the "front switch," which is one way to switch knives from your non-throwing or "off" hand to the throwing hand. As for the overhand, it is naturally a slow-releasing throw because of its

Chapter Three
Spear-Style Knife Throwing

71

elongated motion, which I know of no way to improve without reducing its velocity too much.

These are the things that can be practiced without moving or throwing off-balance, and are therefore the safest things to practice. You cross a line when you decide to start throwing knives without your feet solidly under you. This is when it starts to get a little dangerous — both for you when you practice, and if you practice enough, for anyone who decides he wants to come at you with a hand weapon. You stop being merely a spear-style thrower and become a combat-style thrower when you take on this willingness to risk the blood of either.

Chapter Four

Combat Knife Throwing

Human beings, like deer clacking antlers or wolves seeking status in a pack, make obvious use of ritualized violence ranging from most martial arts contests to fake territorial wars fought over inflatable balls to staged pro-wrestling exhibitions. Some say this is to reduce the need for real conflicts that would endanger people's lives, although of course our species also has at least as many of those as any other. The most common of these social rituals among ordinary, everyday human males seems to be verbal bravado, occasionally escalating into a push-fight or fistfight. These have very little to do with real violence because, like those rutting bucks or snapping wolf cubs, they end in the death of a participant only rarely, and then by accident more than design.

A serious conflict is one that has no rules. There are no limitations whatsoever on the participants, whether they are the arbitrary rules of some silly game or the unspoken social rules governing typical parking-lot fights and such schoolboy pastimes. Fights involving knives are serious conflicts almost by definition. The only time you are ever justified in using one against another human being is if your life is in immediate danger from that person and you cannot escape.

Combat Knife Throwing
A New Approach to Knife Throwing and Knife Fighting

74

There is no way to predict what kind of situation this might be. If you were in a position to know in advance that you were entering a dangerous situation, obviously no one would ever “bring a knife to a gun fight.” Real-world violent conflicts do not often come with invitation cards. One thing is for sure — if you ever use a throwing knife against an unarmed person who is smaller than you, you’d better get a creative attorney. That would seem like a hard self-defense case to make.

The only starting assumption we will make, then, is that for some reason you have decided to carry throwing knives for use in self-defense against a potential armed assailant. This is not so unrealistic as it might seem at first. Obviously the advantage a throwing or projectile weapon has is the fact that you don’t have to endanger yourself by engaging the opponent at close range, and throwing knives do have some advantages as opposed to pistols or other projectile weapons. They are silent. They are a little easier to conceal. You might get in less legal trouble for carrying them. They are not quite as automatically lethal as guns. They are not as expensive to practice with (but more fun). They won’t blow up in your hand or go off in your pocket. Lastly, they might even come in handy for something other than attacking somebody.

There are also advantages other than greater range to throwing knives, as opposed to using knives only in hand attacks. Throwing’s biggest advantage might be the element of surprise. With a really quick release you might get the knife there before your opponent ever suspected it was coming, giving you overwhelming, unexpected offense. Throwing could be used defensively in the sense that it could be used to keep an opponent at bay until either he or you were able to flee the scene, which is the best outcome for any knife fight — it ends with everyone alive.

Throwing might even be the best way for the non-aggressor in the situation to end the conflict while placing both parties

Chapter Four
Combat Knife Throwing

75

involved in the least possible danger, since a gun would more likely kill the attacker and doing nothing would make a victim of the attackee. And while slashing attacks are not available when throwing, this is not as great a consideration as you might think. Stab attacks in general do far more damage than slash attacks, and a thrown knife hits much harder than any hand stabbing ever could, because your hand isn’t absorbing any of the energy of the knife’s impact. The only clear drawback of throwing as opposed to hand-stabbing is the fact that a throw can’t be adjusted as easily to get around clothing or other obstacles, or twisted once inside the victim.

If you decide to carry knives as opposed to merely practice with them, you’ll next have to decide how many, how big, and how sharp. Bigger knives have better range and more power and also give better defense as a hand weapon (as a sword would), but are clumsy to carry around, harder to conceal and have a much slower release. Smaller knives are very quick and accurate, but don’t have the same stopping power. Of course, if you intend to use knives for self-defense, you will want to at least sharpen the blade and maybe even make the point a little sharper. (As you’ve learned, in practice it is best to have points as dull as you can get by with, to keep them from breaking as often.) And remember this: If you are ever in a knife fight, under no circumstances should you throw away your last blade. To do so would be to disarm yourself.

The intention here is not to use throwing knives to entirely replace conventional knife-fighting skills, but more to supplement those skills in a novel way. Combat-style knife throwing involves a set of both offensive and defensive skills — notably, skills that you can practice *alone* — that might give you the winning edge against even a superior assailant. Things like street awareness, fast-drawing a knife from its sheath, conventional combat knives and combat grips, utilizing grappling and striking attacks in a knife fight, dealing with ambushes or mul-

Combat Knife Throwing **A New Approach to Knife Throwing and Knife Fighting**

76

tiple attackers, blocks for hand attacks, and so on are not dealt with here in any detail; for these you should consult any of the number of good books available on knife fighting. Most of what we are trying to do here is to prevent a fight from ever reaching the point where most of these conventional skills are even necessary.

It is, of course, my sincere hope, both for myself and all my readers, that the abilities and concepts we are trying to develop here are never used for anything but recreational purposes, but it seems to me that, if you are going to practice throwing knives, you might as well make it as potentially useful a skill as possible. The only real-world application of knife throwing, aside from maybe small-game hunting (covered in the final chapter) is hand-to-hand combat. If, as I am sure you also wish, knife throwing is kept at the level of a sport, it is a sport whose rules should nevertheless be defined by combat. What follows is an attempt to do so.

Combat Stances

Anyone familiar with hand-to-hand fighting at even a rudimentary level knows that a basic defensive fighting stance is not entirely unlike the basic stances we first learned to use to throw a knife overhand or sidearm. A boxer who is right-handed, like a right-handed thrower, generally stands with his left foot closer to his opponent than his right. This, naturally, is to make himself as small a target as possible; the side of the body is harder to hit than the front. Of course, when a boxer (or knife attacker) switches to offense, if he wants to use his right hand he will have to compromise that stance to some degree to reach his opponent, but by doing so he leaves himself more vulnerable in turn. This constant trade-off between defensive and offensive position could be said to be the essence

Chapter Four *Combat Knife Throwing*

77

of unarmed hand fighting, but it can be a little different with a knife.

While sword-fighter stances, where it is the right foot that leads because the length of the blade itself acts as defense, are universally ridiculed by knife-fighting experts, it is still possible for a quick, aggressive knife fighter to lead with his right foot if he remains in good balance while doing so. This is partly because a knife, unlike a punch, can be deadly effective on the first strike, and a fighter who is quick enough making one might never need to resort to defense. After all, another thing that all the experts agree on is that knife fighting is all about offense, not defense. And if there is little defense against a conventional knife attack, there is even less against a throwing knife.

Two things concern us as knife throwers about fighting stances: One, does the one we use ourselves leave us both protected from the opponent and able to throw a knife effectively; and two, how does the stance the opponent is using lend itself to dodging or blocking a knife we throw? We would at least seem to be in luck regarding the former. The closer to a right angle that a knife thrower's shoulders are to a target, the more power that can be generated with the throw, so the best defensive stance for a thrower happens to also be the most powerful offensive stance. Doesn't this make our choice of stance simple?

On paper it might seem that way, but of course, in the real world nothing is ever so easy. The overhand is a very slow-developing throw (that is, one that's easy for the opponent to see coming) that requires stepping toward the opponent to get most of its power, leaving the thrower in very poor defensive position just as the knife leaves his hand and just before he can get another one. Anyway, you might not ever even get a chance to fall into a preferred stance that you are accustomed to. Since you are going to be moving around, dodging attacks

Combat Knife Throwing
A New Approach to Knife Throwing and Knife Fighting

78

from the opponent, you must learn to throw a knife from off the wrong foot (or even no feet at all) in something like the way a boxer learns to immediately shift his balance to take advantage of an opponent who just compromised his defensive integrity. (Again, it is very useful to conceive of combat throws as merely long-range punches.)

A knife thrower clearly would prefer to stay as far away from his opponent as possible, so your preferred defensive "stances" are probably called "backpedaling" and "sidestepping," but since one of knife throwing's greatest strengths is its first-strike capability, you may also want to put yourself into position to immediately launch an attack.

If you do get the chance to square off against an opponent before he attacks, the sidearm throwing stance is likely the best trade-off between offense and defense. It is a little more open defensively than a boxing or overhand throwing stance, but its quick-release capability, accuracy, and power more than make up for this slight deficiency. Most importantly, the beginning sidearm stance, with the knife arm cocked back, is a "triple-threat position," by which I mean that three different throws are available without picking up the feet. After you have developed sufficient velocity and the ability to twist your abdomen, you will be able to throw not just the sidearm throw (and that with your weight on either or neither foot) from this stance, but also effective underhands and wraparounds. And with a single step in any direction, you will be able to throw a powerful overhand with its greater range and/or downwards-angled flight, even throwing off the wrong foot while falling backwards or sideways, or jumping in the air.

An opponent can assume any number of unpredictable positions — for instance, he could get very low to the ground, with his head tilted forward to protect his neck and his arms and legs protecting his vitals. However, the stances he will have to assume to attack are somewhat more predictable — he will

Chapter Four
Combat Knife Throwing

79

have to be more upright and less defended. And since as a thrower you will have the ability to strike before he reaches you, you should be able to wait for him to open his defense in this way before you strike. That is, you wouldn't have to throw at him until the moment he assumes a more conventional, offense-oriented stance. Therefore, for our purposes there are three basic stances that an opponent can take: leading with his left foot, leading with his right foot, or standing facing us.

If an opponent stands with his feet apart, facing you as if he wants to shake your hand, he is either crazily confident that he is in no danger or a totally inexperienced fighter of any kind, and so we can dispose of this stance quickly. The whole front of his body is exposed for an easy throwing attack. He would have trouble blocking a knife and probably could only dodge a throw at his head or extremities, if that. You must make a snap decision about whether or not you need to throw at all, this person might not actually be looking for a fight, since this is a counterintuitive, non-instinctive body position for anyone with violence on his mind. (By the way, did you know that a person who is expecting to fight will turn white in the face, not red? This is because the blood leaves the surface of the skin when the body senses real trouble; a person who is turning red is more likely to be feeling embarrassment than real rage.)

Combat Knife Throwing
A New Approach to Knife Throwing and Knife Fighting

80

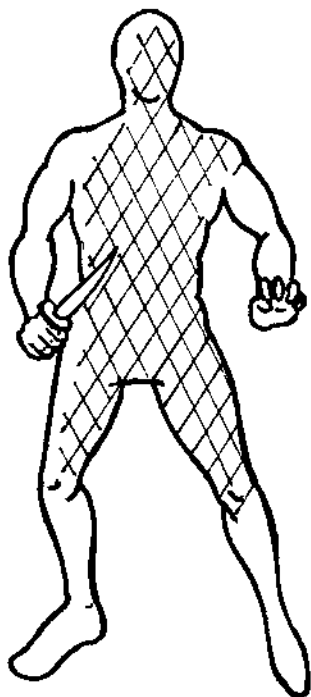

Figure 21

A man standing in a frontal position with a knife or other weapon might be looking to make someone a victim in a big hurry — maybe you, maybe himself. The shaded areas represent your choice of targets.

The second stance we have to deal with is the right-foot-forward stance, which means for a right-handed fighter, that the knife hand is also forward or can become so very quickly. At combat range, a person in this stance is probably even easier to hit in his vital areas than a person facing you directly. For a right-handed thrower, the knife will arrive into the front of the body of a person standing facing to his left (the thrower's right) a split-second earlier, as it is at the natural an-

Chapter Four
Combat Knife Throwing

81

gle for a right-handed sidearm to reach. It would be very difficult for the opponent to dodge or even block a knife coming in from this angle. A right-hander in this stance is likely to be at close range or intending to attack immediately, so there might not be time to do anything but plant one in him as quickly as possible.

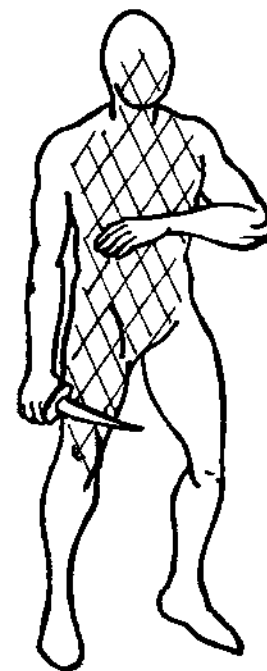

Figure 22

A man in a right-foot-forward (swordfighter) stance can get to you with his blade in a hurry, but not as quickly as you can get to him, with the easy throwing angle to vital target areas (shaded) this stance gives a knife thrower.

Finally, we have the tried and true facing-sideways, left-foot-forward stance, the one preferred by professional combatants of all types. (The next time you talk to a cop, notice if

Combat Knife Throwing
A New Approach to Knife Throwing and Knife Fighting

82

he isn't standing this way unless he knows and trusts you. If he's not, he is ignoring his training.) This is by far the most difficult position for a right-handed thrower to overcome. The left arm, which in a knife fight might very well already be raised as a block anyway, can whip up and try to block a knife aimed at the waist up, if he reads your intentions. The lead leg is an available target, but if his weight is more on his back foot as you throw, he might be able to make you miss. Most importantly, attempting a throw at the head is probably out unless you are much taller than your opponent and can use an overhand with a downward angle. It is very easy for a person in this position to simply rock his head back or dip it forward to avoid a knife thrown sidearm at his head, because of the sidearm's more horizontal angle. It is a Christmas present for a knife thrower to find an enemy in any position but this, but since Christmas only comes once a year, we will have to assume during practice that this is the opponent's stance.

Chapter Four
Combat Knife Throwing

83

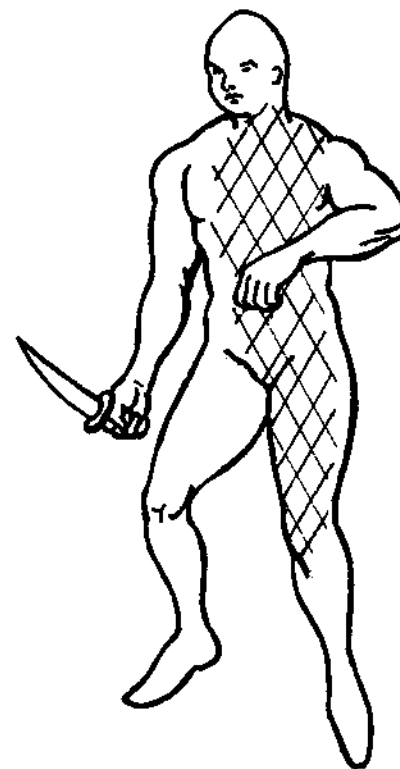

Figure 23

A man in the conventional stance presents the smallest target area (shaded), and can easily whip his head backward to dodge a thrown knife.

Of course, all the problems associated with stances can be solved with one simple method: ambidextrous throwing. A left-handed sidearm throw would come in from the vulnerable side of an enemy in a left-forward defensive stance. This stance is meant to account for hand attacks from right-handers, not left-handed knife throwers.

Practice Scenarios

As I said, if dangerous situations were predictable, we wouldn't get into them to start with, but to best conceive of how to use knife throwing in a fight, it is necessary to understand some simple facts and at least make an attempt to draw some conclusions from them. Since the author has yet to get into a live-fire knife fight and fully intends to keep it that way, the possible scenarios we are about to present here are a bit speculative. One fundamental aspect of these proposals, however, is based almost entirely on something the author does have a great deal of practical experience with. It is called the Mallard Theory of Knife Fighting, and it can be summarized with a single statement: A man at whose head a knife is flying will make like a mallard, and duck.

But didn't I just say that a throw at the head is the easiest to dodge from the conventional defensive stance, and isn't that the stance we most need to try to overcome? Indeed it is so, but the mallard theory applies equally well when a man only *thinks* that a knife is aimed at his head, or anywhere near. And while its bobbing action on the neck makes the head very easy to move, that doesn't mean that the neck itself, or the torso it is for the time being attached to, can move nearly so quickly. As we will see, this might work to a thrower's advantage.

Don't just take my word for any of these things. Different people have different abilities and what seems logical and best for me won't necessarily work for you. You can test some of these proposals yourself using what I call "sock practice." Tragically, this doesn't mean you actually get to sock anybody with anything; it just means you wad tube socks up into balls and throw them at somebody. Get three or four of these (or something similar) and give a friend a rubber knife and see what develops. After all, anything you can hit with a sock you

will certainly be able to hit with a knife, if you're practicing. A knife travels faster and more accurately than anything light and soft enough to be safe to throw at someone, and its greater length allows you to change its direction much more efficiently and quickly than you could any ball, just by turning your wrist and angling your fingers. That length also helps it get where it's going a little quicker.

The First Throw

We will assume a combat range of 6 to 12 feet. If you can get more than 12 feet away you are probably either able to run away from the situation (which you should of course do at the first opportunity) or out of your most effective knife-throwing range. (With enough practice a man with an average arm will be able to throw even a small knife spear style with good striking power for at least 15 feet, but why risk missing from 15 feet when you could take a step forward and hit with far greater assurance at twelve?) If you are closer than 6 feet you are likely about to engage the enemy hand-to-hand or with an uppercut throw while moving backwards, because you, as a thrower, want to minimize the risk to yourself by staying at a safe distance. Space, not stance, is the thrower's best defense.

At this range it is very easy for an experienced thrower to hit a man in the ribs with a sidearm throw, even if that man is in the left-foot-forward stance, unless he blocks it with his forearm. This would be a situation about as bad for him as a rib strike, since his left arm is his primary defense and blows to the arm greatly affect its speed and range of motion. A single solid hit to the forearm with a knife could render it useless even if it did not crack a bone or sever some tendons. A rib strike would be painful but most likely not lethal, unless it was a bigger or sharper knife that slipped in between them. Also, it

Combat Knife Throwing
A New Approach to Knife Throwing and Knife Fighting

86

is likely that the ribs would be covered by more clothing than the forearm, or at least clothing that could more easily turn a knife blade aside, such as an open-front jacket flopping around. Another fairly easy target is the upper leg, especially if you catch him leaning forward. A strike to the kneecap could incapacitate your opponent for at least enough time for you to get away. The entire area from the knee to the shoulder is relatively easy pickings for a knife thrower, a broad but most likely nonlethal vertical target face — kind of like the poles and boards you practice on.

The problem with using nonlethal force in a knife fight is that it might not drive your opponent away or wound him badly enough for you to escape; it might just enrage him and cause him to charge. Throwing a knife at someone will almost surely force the “fight or flight” reaction. When a man realizes that you have him outgunned from long range, the only things he can do are either decide to get out of there or immediately introduce you to the business end of his weapon. He has little choice. If you choose to aim your first throw at a nonlethal area, you are essentially gambling that this will cause him to give up without further contest. But what if he does not?

The fight or flight reaction is the reason that you are unlikely to get more than a few throws in a knife fight, unless you have enough space to work in and are quick enough to play bullfighter with your opponent. Your first throw will almost certainly determine the future course of the fight. It is your best opportunity for a surprise throwing attack, when the opponent is least expecting it. Do you want to spend this opportunity on a nonlethal attack, one not guaranteed to work? You must answer this question as best you can in a split second, if it ever arises.

One of the most vulnerable areas of the human body is also one of the spots we are least likely to cover with clothes or other protection. The throat area contains, not so far below the

Chapter Four
Combat Knife Throwing

87

surface of the skin, the trachea, the larynx, and the jugular veins and carotid arteries. These last two are especially vital and vulnerable, and there are no bones protecting any of these. You will notice that in the left-forward stance the side of the neck presents itself as a target just above the curve of the shoulder (unless the opponent has an unusually high arm block, leaving his guts wide open).

An accurate throw aimed just above the collarbone, at the side of the neck, might have the best chance to have nearly instantly fatal impact on the enemy. He will flinch when he realizes that you are throwing toward his head, and move in an unpredictable direction. But if he ducks forward, the knife you aimed at his neck will now hit him in the side of the head, perhaps in the side of the face or the vulnerable temple area. If he ducks back he will likely not be able to move his upper body quickly enough to get the lower part of the neck entirely out of the way (notice that the neck tilts *forward* from the body). If he puts up a hand or forearm block started from a normal position, he will have to do so even as you are throwing for it to be fast enough to be effective — and remember, if he is moving as you throw you can also change the angle of the throw at the last instant. Also, knives have a way of glancing easily off of things like bones and ending up about where they were headed to start with. A man would at least have to put himself in an off-balance position of some kind to get out of taking damage from this throw, and the moment he did so would give you the chance to charge him for a hand attack, or at least get another knife to your throwing hand and look for another good target. Your first throw is your best one, and if you are looking to make it the most effective in terms of damage, the neck, as soon as it opens up as a target, is generally your best shot. Obviously this is a desperation move to only be used against someone who you are sure is trying to kill you; if a throw gets to a man's neck it could surely kill him, even instantly so.

Having made the choice of what the first throw you attempt will be, you must now decide on the second. This will be an easier choice, because it will more likely be determined by what your opponent's reaction to the first throw was than by anything you do.

Additional Scenarios

If the opponent doesn't charge after you let loose your first throw, your decision is simple. You can tell him there's more where that came from and if he doesn't concede immediately, hit him again (assuming you hit something besides air on the first throw). If he is on the ground, aside from a hand attack you now have the overhand available to you, the most powerful throw and the natural choice for low targets. If he does try a rush attack, you have other options.

The first and best option is to get out of the way. This means backpedaling or sidestepping. If you also choose to throw while stepping backwards, the best throw is usually the overhand thrown off the back foot. This brings up an important point. Unless you are far more confident in your accuracy than I, you will carry as many knives as is comfortable, but unless you use only the smallest knives, it is only feasible to have three or four in your hands at once — one in your throwing hand, the rest in your "off" hand. Feeding knives from off hand to throwing hand as fast as possible without dropping them is a vital skill; there are two ways to do it. If you have to switch a knife from your off hand to your throwing hand in order to make a quick throw while moving backwards, it is best to do so behind your back. This is because, if you don't, you'll have to make an extra motion to cock your throwing arm back; if you just grab the knife around the back the arm is already cocked. I call this the "back switch" and this is the

only time it is used. If you are standing still or moving forward, it is much safer to switch the knife in front of your body (called a "front switch," naturally).

If you decide to sidestep, your preferred direction as a right hander is to your right, since this leaves you with better defensive position and the ability to throw without having to set your shoulders first. Of course, you might be in an enclosed space or at an angle that makes stepping rightward or backward impossible, in which case you will have to make other travel arrangements.

If you have to move suddenly to your left or "off hand" side, you might consider using a spin throw. This is not a throw where the knife is spinning in any way — that's still considered undesirable — but where *you* are spinning. As you step to your left, you just keep on turning counterclockwise and spin your whole body around 360 degrees, ending the motion with a right-handed throw of some kind (since you turn your back to the target you'll have to decide what throw you need at the last instant). The reason to do this is simply because it lets you get off a throw while moving left at least as quickly as you could by trying to turn your shoulders against the momentum of your body, but far more powerfully. If this seems like one of those useless martial arts choreography moves because it is so slowly developing, think again. As a thrower you keep much more space between you and the opponent than someone who is trying a hand attack. While this can make it easier for the opponent to see your moves coming, it also gives you access to a broad repertoire of more complex motions such as this.

The last option is to stand your ground. If the opponent gets too close you won't have time to throw; you have found yourself in a conventional knife fight. However, if you are ever in a position where you need to get off a throw quickly at a lunging opponent to prevent him ever reaching you in the first

place, the uppercut throw is better suited than any other. This is because it starts low and comes at a natural upward-moving angle. A man moving quickly forward will have his upper body leaning forward, and this throw can release a knife into an opponent in such a body position almost immediately. If the man is more upright, it can send a knife into his guts or even the underside of his jaw by getting inside of his forearm block. In a situation this desperate, one ideal target of the uppercut is the liver, as this is another instant-death spot if hit hard enough. The liver is the prime target on the front of the trunk because it is more exposed than the heart. The heart is protected by the sternum and nearly invincible to a throwing attack. Also, from the uppercut position you can always change your mind at the last moment and just hand-stab at an upward angle, and so keep your knife. The uppercut is the best last-resort throw you can use on someone who fails to respect your personal space in a way you find appropriate, namely by trying to kill you.

Other Techniques

Another method that can be used to defeat defenses is the use of foot-feints. By lifting your feet slightly, shifting your weight, waving your knife around in false starts, and so on, even an opponent expecting a throw might get faked out. The most effective finishing move for this is when you are in the sidearm stance and lift the left foot off the ground while cocking the knife back. Your opponent will intuitively think you are about to step forward to throw. You then put your foot back on the ground, causing him to think it was just another feint. At that moment, the instant you have both feet planted on the ground, you deliver a sidearm. Most people don't ex-

pect someone to throw flatfooted, especially if you've already shown them a throw that you did step into.

A few words should be said on the backhand throw. Beginners can fall in love with this throw because it seems so easy to make at first, but look at it more closely before you start practicing it to the exclusion of all else. To make this throw you have to be in right-forward stance if you are right-handed, the worst of all defensive stances. The motion that begins the throw involves drawing your right hand all the way across to your left shoulder, and then flinging the knife a couple of feet forward. In part because it's easy to dodge, this throw isn't effective at any range past three or four feet, let alone the kind of range you, as a combat thrower, should try to maintain. Only the wraparound keeps it from being the weakest of all throws, but the backhand does maintain the dubious distinction of being by far the slowest-developing throw in existence. If you let someone get within this throw's effective range and draw your knife hand back across your body with your right foot forward, the knife will never reach its destination. The enemy will simply pin your throwing arm against your body before you ever even throw it and quickly slit your throat, and you will be in no position to do anything to stop him. If by some miracle you did get the throw off, he could easily dodge it just by stepping to his right and you couldn't possibly change the throwing angle to meet him there, not with this throw. And, of course, you would be lunging forward empty-handed as soon as you finished the throw, which would let *him* finish *you* at his leisure. Have you ever seen a boxer trying to hit his opposition with a backhand *punch*? Try the backhand in sock practice and see if you think it belongs in your arsenal of combat throws, or somewhere between juggling and twirling in your grab bag of novelty knife tricks.

As you grow more advanced you can start to think in terms of combination throws. This just means, as in boxing, that one

Combat Knife Throwing
A New Approach to Knife Throwing and Knife Fighting

92

throw is used to set up the next. For instance, you can throw a sidearm at the neck to force a high arm block, and while the opponent has his arm up, hit him in his exposed guts with an uppercut. An uppercut to the groin would force a low block, allowing a sidearm follow-up to the head to finish him.

An ambidextrous thrower could throw left-right or right-left combos that would be nearly unavoidable for an enemy, since they would come from different angles in rapid succession. All of your skills — switching knives to the throwing hand, quick releases, feints, and accuracy — have to be working for you to pull off combination throws. You can even incorporate spin throws into combinations if you are confident that you can instantaneously adjust the second throw, the one you will make as you finish the spin, into the target area you open up with the first throw. Spins have the benefit of being confusing and unexpected; throwing from them only compounds this. The best spin combo incorporates the mallard theory. Standing from about twelve feet, you step forward and let loose an overhand at the opponent's head; you are already into your spin as you release it and should be turning around just in time to see your victim ducking. Give him an iron facial with an immediate uppercut as you finish the spin.

Hitting moving targets is not as hard to practice as you might think. At combat ranges, the opponent will not be able to move to avoid a throw unless he anticipates that it is coming and moves as you make the throw. There is, therefore, really no reason to learn to throw at sliding or propelled targets of the kind archers or hunters use; what matters is being able to adjust the release point of a knife at the last instant. Aside from sock practice, you can simulate moving opponents by putting up a number of targets — they will probably have to be pole targets because those are the only ones that give a 360 degree target face — and picking out random ones to throw at, as fast as you can. Move your body in a way that is

Chapter Four
Combat Knife Throwing

93

intended to hit a target right in front of you, then at the last instant change to a target to one side, or vice versa. Run from target to target retrieving knives that have missed and are lying on the ground in random areas, and throw from those spots as quickly as you can without even setting your feet. While you couldn't count on being able to use this particular skill in a fight — after you've thrown a knife, you've probably lost it for the duration — it is good practice for throwing off-balance. And you will learn something else. In "panic" situations such as these, even practice ones, you start doing things you don't do at slow speed. You drop knives, your feet slip, and you get less accurate. The only one of your skills that never takes a holiday is velocity, another good reason why it is the main emphasis of combat-style throwing. Try to throw all your combat practice throws at full speed.

Lest you think that combat practice is all deadly seriousness and dour faces, let me lighten your mood with some zany anecdotes culled from my misspent youth in the wacky world of knife-slinging. I call them "cut-ups." Let me know if you don't smell a sitcom here.

It was a bad day to be throwing knives — the ground was wet, I was half-asleep, and it was so hot I was wearing shorts. I was walking to pull two 14" bayonet blades out of a target, with one blade still in my hand, when I somehow slipped stepping over a piece of tin propped upright against some trees, which I was using as an experimental low backstop. I dropped the knife in my hand as I fell and caught myself just before my face hit the ground. As I did so I rolled into the tin with my legs, and angrily kicked it away since I conveniently blamed it for the whole thing. After I got up, still a bit dazed from sleepiness and the spill I'd just taken, two things were confusing me: One, where in the heck did that knife in my hand go, and two, why could I still feel that piece of tin against my leg

Combat Knife Throwing
A New Approach to Knife Throwing and Knife Fighting

94

when it was now lying 3 feet away from me? It turned out that these two questions had the same answer. It seems that the knife in my hand had somehow managed to stick completely through my lower leg, coming in one side and going out the other like an arrow. I had been carrying it around with me, in an improvised sheath made of my own flesh. That wasn't tin *against* my leg at all, it was my missing knife *in* my leg. Silly me!

It was the next day that the real hilarity started. I had decided not to get stitches for the wound because I wanted to see how long it would take to heal without them, and like any red-blooded American boy, I wanted to have that cool scar to show off. A night of holding the leg upright, wrapped tight with bandages, had finally stopped the bleeding — or so I thought. Imagine my chagrin the next day when the wound reopened as I was walking down a busy public street. The punchline is that I was wearing white socks with a white shirt, but soon I was wearing one red sock. Speaking of “red-blooded” — what in the world does *that* go with? What a fashion faux pas!

Then there was the time that I was teaching a friend to throw knives and started tossing them back to him from a distance, just to avoid his having to walk all the way to the target to get them or me having to walk to take them to him. When it was my turn to throw, he courteously started to do the same for me. I casually reached out to catch his first toss and realized that in fact, he could catch knives when they were thrown by me because I always put them to him with the handle pointing forwards, but I could not catch knives thrown by him because he was not able to do the same. Uh-oh! That's the kind of thing that might leave a mark! And darned if it wasn't my right hand. It seemed I wouldn't be catching, or even throwing, much of anything else for quite a while!

Chapter Four
Combat Knife Throwing

95

I used to keep my throwing knives in the same sheaths as some other fun things, among them sharpened fighting knives. Once I was throwing my biggest bayonet blades from close range at a pole target and one flew back at my well-deserving head. I had to hit the ground hard and flat on my back to avoid it. When I got up the knife was stuck into the ground just above where my head had been lying. I laughed this off and kept on throwing, thinking little of it in my typical adolescent illusions of indestructibility. I wasn't laughing so loud when I went inside and removed the narrow but thick piece of belt leather I had been using as a headband (to hold my safety glasses on and keep the sweat out of my eyes). It was cut nearly in two, right in the center of where it fit against my forehead. I had evidently unthinkingly sharpened at least one of my throwing blades the night before when I had sharpened the other knives they were stored with. The one that had just missed my head missed by a much smaller margin than I had thought.

If the “point” of all this escapes you, you might not be so lucky with a knife. Playing with sword or bayonet blades (especially ones a foot and a half long) is dangerous and if you practice combat-style throwing you are going to get hurt on occasion, probably not too badly if you are careful and take reasonable precautions, but the risk is there. You need to be in acceptably good physical condition and very experienced with these things before you even start to consider full-scale combat-style throwing of the kind described here. A single moment of carelessness is all it takes.

With this said, knife throwing in this style can condition your reflexes to dodging and blocking knives like nothing else I know of. It is about as close to live fire as you can get, not so much from thrown knives (which you are unlikely to ever face), but from conventional stab and slash attacks. Knives can glance back at angles and speeds that are very similar to hand

attacks. Sock practice against a rubber knife just isn't the same.

With experience, it is possible to angle throws in such a way as to cause most of them to glance away in a safe direction if you don't stick the target, and you can, of course, wear protective equipment to make even this aspect of knife throwing as safe as possible, but there is one advantage in choosing not to do either. You place great pressure on yourself to make the throw or potentially face the consequences — as might happen in a real fight — if you simply throw with full velocity at the center of a hard, skinny pole target while stepping into the throw. You either hit the throw or the knife glances off unpredictably. If it comes back at you, you may or may not have a chance to dodge or block it. You might pluck it right out of the air with your hand. You might contort your body in shapes you didn't know were possible. (I once did a midair split to avoid a knife coming point-first at a particularly delicate section of my anatomy. I have never before or since been able to do any kind of split.) I do not recommend doing things like this and I never do them myself, at least not anymore. At a certain point you grow used to being cut and at a certain point you get tired of it.

Chapter Five

Psychological and Physical Conditioning

All life on earth exists as fairly discrete units, such as species or individuals, which are always specialized parts of an interconnected web of other such units. A species of animal is a breeding population whose very existence is defined by the niche it fills in this larger whole. A cheetah isn't a cat that just happens to run fast; cheetahs came into existence precisely because there was a niche to be filled in the African environment for an animal that could catch small deer and antelope. Running fast is the very definition of a cheetah; it is how a cheetah gets its dinner and how it avoids being something else's dinner. Any animal that cannot do these two things won't ever come into existence to start with. No one questions what the most "athletic" cheetah is — it is the one that runs the fastest. There is only one event in the cheetah Olympics, the sprint. To ask a cheetah to be stronger or a better climber is meaningless, since this would be to ask it to be a lion or a leopard. These abilities are not part of its makeup and are not supposed to be.

To define what a human being is physically, then, we must apply this line of reasoning to ourselves. How were we originally designed to get our dinner and avoid being something else's dinner? Anthropology is still an inexact science, but to

Combat Knife Throwing
A New Approach to Knife Throwing and Knife Fighting

98

these questions there is broad agreement. When this omnivorous primate species wasn't gathering plants, it formed packs (primarily if not exclusively made up of males) and cornered prey animals by wearing them down with superior endurance, then killing them with tools specially designed for this purpose. (As far as avoiding being dinner, their only real natural enemy was and is each other, and they used much the same methods against other human packs.) The upright stance of the human animal is poorly suited to sprinting, leaping, and such, but works better for a variety of activities like swimming and climbing, especially long-distance running. Humans seem to be relatively hairless for the same reason they sweat: to cool the body more efficiently, allowing them to run greater distances than any other species. The upright stance also allows the use of spears, slings, and other such hunting and fighting implements. A human being is a hierarchical social animal whose fundamental physical qualities are adaptability, endurance, and manual dexterity. This is the human niche.

Why, then, are we told by our TV sets, magazines and newspapers that American football players, who are mostly rotund giants with taped-up hands who start wheezing after a few minutes of wrestling each other around in between breaks, are "athletes"? Why are we expected to believe that awkward 7' freaks lumbering up and down wooden floors while trying to bounce oversized balls possess physical qualities we are supposed to envy? What in the world does swinging some kind of club at a ball or other hunk of rubber have to do with anything, let alone defining human beings as a species? The word "athlete," as used by the American mass media which profits from and promotes these events, is in reality a sort of code word for a specific type of entertainer (often African-American) who possesses a set of skills that have virtually no real-world applicability. Similarly, while there is nothing in-

Chapter Five
Psychological and Physical Conditioning

99

herently wrong with events which overwhelmingly favor sprinting, jumping, bodybuilding, and so on, humans are not designed for these activities any more than penguins are designed for flying.

On the other hand, that kid you see on a bicycle or skateboard has adapted his method of locomotion beautifully to his environment of concrete surfaces and metal railings. That woman who jogs by your house every day would survive in situations where many a professional "athlete" would not. Disc golfers, like the spear-chucking ancestors of all of us, can throw things with great velocity and accuracy; can their highly paid counterparts who whack balls around say the same? So-called "alternative" sports are often far more compatible with our genetic heritage than the TV sports sideshows, and they're almost always more fun and more sensible to do.

The words "athlete" and "sport" have been co-opted by mainstream marketers to such a degree that you might have trouble making others understand why it is you like to throw knives, but don't be discouraged by the brainwashing that sneaker salesmen have foisted on the public. The words don't matter; the reality matters. Real athleticism is largely about endurance and the ability to hurl simple weapons, because those are the things that brought our species into existence to start with. (There are deep reasons why we always make the pitcher and the quarterback the star, even in TV sports.) For a human being, especially a male, to want to sling pointed objects at things is as natural for him as to want to breathe. (Incidentally, the fact that knife throwing is sure to be a preoccupation of males more than females is why I have chosen to use the masculine pronouns throughout this book.) Apologize to no one for your love of throwing knives. Are you any crazier than some inebriated guy rolling a ball at some bottle-shaped pins or hitting softballs into a fence with an otherwise useless aluminum club?

Combat Knife Throwing
A New Approach to Knife Throwing and Knife Fighting

100

With this understood, we can still turn some commonly played sports to our advantage, to help us better understand ourselves as knife throwers. Other than those social events that feature throwing in some capacity, such as softball or flag football, the activities that are most like our style of knife throwing are the combative sports. You can use boxing, especially, to understand the kind of footwork and attack angles you are likely to see in a real fight. The drawback with traditional boxing — the fact that kicks, holds, and such are not allowed — doesn't affect throwers as much as martial artists, because we always want to stay on our feet and use our hands anyway. A knife thrower who lets a fight turn into a wrestling match has already failed miserably. Boxing also helps you learn some of your strengths and weaknesses, such as how fast and coordinated your hands and feet are relative to most other people; another sport good for this is basketball. The problem with these sports is that they can actually decondition your reflexes, in that you will learn to accept some things that are unacceptable when dealing with knives, even in practice. You can't afford to let someone hit you at all if he has a knife in his hand instead of a boxing glove, or try to hand-check a glanceback when you can get out of its way.

Knife throwing can make an excellent "lifetime activity," to steal a term from current physical education jargon. As your waistline expands and your reflexes diminish, unlike many other sports, you don't have to place yourself at risk just to burn a few calories. All you have to do is stop throwing combat style and turn to the recreational types of throwing, more of which are presented in the final chapter. The best physical features for a knife thrower to have are a strong, flexible abdomen and lower back, to generate power on sidearm and up-percut throws, and well-conditioned legs to be able to get around on without endangering yourself. Your shoulder and maybe your legs and back will get sore the first time you

Chapter Five
Psychological and Physical Conditioning

101

throw overhand, but this disappears. After a while you will be able to throw for hours without anything getting sore even if you are throwing at full speed, especially if you aren't just practicing the same throw from the same range. Using the infinite variety of angles and ranges available prevents too much strain on any particular area of the body, making maladies like tennis elbow unlikely.

There is a single definable quality that, if developed, will allow you to perform much better in *any* physical activity. All other things being equal, it will have the effect of making you stronger, quicker, faster, and more coordinated than someone who possesses less of it than you do. It doesn't come from having bigger biceps or a better vertical jump. In fact, it is controlled by something you can't even see from the outside. Before you think I'm about to get corny and say "you've got to have heart" or some gibberish like that, I am talking about three little bones in your inner ears. I am talking about your sense of balance.

Balance is fundamental in any sport, but it is the distilled essence of knife throwing. If both the knife and the thrower are in good balance, the battle is half won. Balance for a knife thrower comes from good positioning of the feet relative to the position of the shoulders. The challenge is to be able to maintain that positioning, or learn to do without it, when the feet and torso are forced to move in unpredictable ways. This, as much as anything, is what separates spear-style throwing from circus throwing — the ability to still get off a good throw when things are not as perfect as you would like them to be.

Physical balance is easier to maintain when you also have emotional balance. Throwing knives (especially combat style) can become an adrenaline rush. There is nothing quite so satisfying as sticking a knife into a target, and when you are denied this gratification for a stretch of time, you can become frustrated and start throwing harder, at closer range, to force the

Combat Knife Throwing
A New Approach to Knife Throwing and Knife Fighting

102

issue. This in turn might lead to your getting hit with a glance-back, which usually won't do anything to quell that adrenaline.

Some theories of fighting recommend the use of barely controlled rage to overcome an opponent, but this might not work so well for a knife thrower. Rage will definitely add range and power to your throws, but it will also cause you to be less accurate by missing high, since you aren't ordinarily accustomed to having that kind of added velocity. It is best for your safety and for your throwing to maintain a mental detachment at all times from your body and its changing emotional states. You can never really use these mostly glandular reactions to your best advantage until you understand them on a mental level as well as the physical and emotional level.

The best purely mental exercise is visualization. The benefits of visualization are well known to sports psychologists. Studies have been done in which three groups are asked to perform an activity, for instance, shooting free throws, and their results recorded. One group is then asked to practice the activity physically for a certain length of time (in this case, obviously, by shooting free throws), one group to merely visualize themselves doing it for the same length of time, while the third or "control" group does nothing. The group that physically practices will, as expected, show the most improvement at the next test, and equally unsurprisingly the control group will show no improvement, but substantial improvement is shown by the groups who do nothing but visualize. So while thinking and reading about knife throwing and fighting aren't nearly as good as practical experience, they aren't entirely useless, either.

Some people are "streak shooters" — they get hot and can hit any throw they want; five minutes later they can't hit the broad side of a barn. This doesn't mean much in a pickup basketball game, but in knife throwing it can be dangerous even

Chapter Five
Psychological and Physical Conditioning

103

in practice. You need to develop as much consistency as possible. Sidearms and uppercuts are the most reliable throws. To develop more consistent control of the knife and maybe even bring on a hot streak almost at will, think positive. Don't worry if you get on a cold streak; attempt some easier throws, then start increasing your velocity again when you get your feel for the knives back. Think of the target as a powerful magnet pulling the point of the knife toward it and dragging your arm behind. Don't ever let yourself believe that you will miss or you already have, and never have pictures of bad throws in your mind. This is negative visualization and will be a self-fulfilling prophecy.

Chapter Six

Hunting and Recreational Skills

There have been, over the years, some bizarre attempts to build knives with points on both ends, knives with various kinds of attached mechanisms that are supposed to control the rate of rotation over different distances, knives with holes in them that are supposed to make a distracting whistle as they spin through the air, objects that can only be described as giant throwing stars, and heaven knows what else that I *haven't* seen. Most of these are aimed at making it possible to hunt game animals with throwing knives. They all grow out of the assumption that a thrower's ability to control the rate of rotation of a knife over longer distances is too limited if he still maintains enough velocity on the throw for it to be effective when it arrives. Doing both of these well at once, like spear-style throwing, seems to be considered by many to be impossible. We will see. In any event, maybe there are simpler ways than inventing new "knives," if that's what we should call them.

Since much of my knife-throwing course is in the woods, I have had countless opportunities to take aim at squirrels, birds, rabbits, groundhogs, and on occasion even skunks, opossums,

Combat Knife Throwing
A New Approach to Knife Throwing and Knife Fighting

106

and wild dogs and cats. I have never done so. To stick a knife into an animal would, aside from likely losing the knife when it ran away, doom it to a slow, lingering death in the bush somewhere. For a man with a full belly and the ability to get to a grocery store, this seems like a needlessly cruel, almost cowardly thing to do, especially for no other reason than to see if he could.

But there might arise a situation where you didn't have a full belly or any way to get one without killing some game. Could you do so with a throwing knife? The short answer is yes. As you should have figured out by now, spear-style overhand throws angled down into the ground are among the most powerful and easiest to make consistently. With a long sword or bayonet blade and good stalking ability, you should be able to hit a small game animal with fatal impact from at least a good twenty feet away. Since rabbits often freeze when they sense danger, they should be among the easiest animals to bring down this way. Raccoons and especially opossums are sylvan, nocturnal animals that are easy targets if you can find them, but throwing knives in the woods and in the dark might not be as easy.

It is a good idea to put single logs on the ground as small-game practice targets, since this is an angle you'll rarely try in combat practice against vertical targets. Even if you never need to hunt with a knife to survive, this skill could come in very handy against an attacking dog.

Recreational Skills

It never fails to amaze me that people who don't treat knives as objects of fun (that is, at least ninety-nine percent of the human race) are, without exception, more impressed with jug-

Chapter Six
Hunting and Recreational Skills

107

gling than throwing. If you stick four out of five sword blades into a target a few inches wide and thirty feet away, people will yawn and ask why you missed the fifth. But if you juggle three knives, a skill that can be learned by anybody in no time, they'll stare in rapt amazement and ask you how you ever got so good. Go figure.

You should be able to throw a knife by the handle up into the air, let it rotate once, and catch it by the handle. This is really a very basic skill and will soon come naturally to anyone who is throwing knives very much. You must be able to do this with either hand, with your eyes closed, before you can get very good at juggling, because this is the way you have to toss knives (or clubs or chainsaws) to be able to juggle them.

The important thing to know about juggling is the patterns. Learn juggling patterns by starting out with orange-sized balls such as baseballs, which are the easiest to throw and catch. The first exercise is to simply juggle two balls in one hand. Throw one softly up about head high with your hands at about bellybutton level, and when this first ball reaches its highest point, throw the other. Catch the first and again time tossing it back up so that you do so when the second throw is at its apex. You will have to throw one more to the inside, one to the outside, and move your hand back and forth between them to avoid them hitting each other. Alternate throws this way for as long as you can. When you can do this with either hand, you're halfway to being able to juggle four balls, as all there really is to that is being able to juggle two balls in each hand simultaneously. This is easy to understand but difficult to accomplish, and only very skilled and talented jugglers can juggle five balls, let alone knives, so we will leave these aside.

Juggling three balls with both hands is actually a little easier than juggling two in one hand, because you have a little more time to catch each ball and you don't have to move your hands

Combat Knife Throwing
A New Approach to Knife Throwing and Knife Fighting

108

sideways as much. To juggle three balls, you toss each ball from one hand to the other. First practice with two balls. Hold one in each hand. Throw the one in your right hand over to your left hand, at just above eye level, and the moment it reaches its highest point, throw the one in your left hand to the right hand the same way. Catch the first one with your left hand, then the other in the right hand. Now, repeat the process, only starting with the left hand. When you can do this either way without the balls hitting each other, put two balls in one hand and one in the other, start off by throwing from the hand with two balls in it, and see how long you can keep the pattern going. If you can do this for even four or five tosses you are already juggling three balls.

The whole trick to juggling is learning to not panic and just throw a ball back up the instant you catch it. Panicking is what leads to your bouncing balls off of each other in midair. Always wait until the ball you just threw is at its highest point before you throw the next ball, and finally a light will go on in your head and it will be easy. It's like riding a bicycle; you never forget how once that light goes on. After you can do it with balls, knives will follow.

Another simple trick, one you will often see in the movies, is twirling a knife or sword. You need a knife at least a foot long to do this properly and the longer the better. Hold the handle gently at about its center point between your thumb and the area on the inside edge of the big knuckle where your index finger attaches to your hand, and simply turn your wrist all the way around in a circle, in either direction, without grabbing the knife with your fingers. With a little practice you will be able to spin and control the knife using mostly your thumb and only moving the wrist gently when you twirl it backward (clockwise to your face). You can keep the knife moving around forward (counterclockwise) by pushing it with

Chapter Six
Hunting and Recreational Skills

109

your fingers as you twirl it. The thumb is the only digit that ever puts pressure on the knife to hold it. This twirl can look spectacular if done rapidly with a big blade, but it is useless for anything else that I know of.

Another type of twirl which is not as impressive but occasionally good for something is the "gunfighter" twirl. Put your index finger under the blade of the knife approximately at its balance point, with the knife pointing away from your body, and rotate the point all the way around once, back in the direction of your body. With a little finger action you can make the handle jump fancily into your hand into a saber grip. This can be useful sometimes when you grab the knife in a clumsy position and want to get it set into your hand quickly. This trick doesn't work so well with many ordinary hunting or kitchen knives, but it is easy with our blades.

Another good exercise is to throw a knife into the air at chest level and catch it backhand with your left hand, in a sweeping right-to-left motion across your body. This looks kind of neat, but there is a better reason behind it. Your left hand is your best defense either in throwing practice or in a conventional knife fight. By training it to be able to grab a knife by the handle right in front of your body in this way, you make it less afraid to put itself in harm's way if you ever need this skill for real. (Of course, if you are a southpaw, you lucky conventional-stance-defeating dog you, you will do this with your right hand.)

Sometimes it can be fun to incorporate juggling, twirling, and spin moves into your throwing practice in a freestyle manner. For example, instead of using a simple front switch to get a knife to your throwing hand, you can flip it around your back with your left hand, let it hang rotating in the air a couple of times as you start your motion for a spin throw, then pluck it out of the air and send it into a target as you finish the spin.

Combat Knife Throwing
A New Approach to Knife Throwing and Knife Fighting

110

That one always wows the rubes and I doubt it would be possible throwing circus style. If you like games with a more objective way to judge your skills, aside from accuracy contests you can also play golf-like games where you score yourself by counting misses. Set up a series of several targets at various ranges, and arrange them so that they require a variety of different throws, perhaps even with obstacles.

When you toss a knife into the air in a way that lets you catch it by the handle, you almost have to do so underhand, and you almost have to let it rotate at least once in the air, at least if you threw it by the handle. Over time, by doing so, you will gain a feel for the way a knife revolves and will be able to do this at different heights or speeds. Standing in your normal uppercut stance, with your normal uppercut grip, you might become tempted to use the underhand flip (as circus throwers call it) to try to stick targets at longer ranges. This throw is the same as the uppercut, only you allow the knife to rotate once on its way to the target. On occasion you will be able to stick one in. You might think, as the circus throwers do, that this throw is nothing but a novelty, an amusement to indulge in between sessions of real throwing. Sure, you can try this throw from anywhere you like instead of just predetermined set points, because you can control the rotation of the knife by the amount of wrist flip you give it, but it hits so softly and sticks in so inconsistently that it could never be very effective for much of anything. If you thought that, you'd be wrong.

Because we balance our knives in such a way that they revolve much slower than circus knives, the degree of control over the rotation of the long-range underhand throw is much greater, especially when we use longer blades. And just as importantly, because we have the specialized underhand grip (the same thing as the uppercut grip) and the tape cuff on the handle, we can hold the plane of the blade vertically for this

Chapter Six
Hunting and Recreational Skills

111

throw, not horizontally as the circus throwers grip it. The cuff doesn't allow the knife to slip from our grip so easily as it would otherwise, which means we can step into this throw more and release it a little later. The vertical blade plane allows the knife to cut the air and travel faster. That throw that is merely a toss today can become, over months or years of practice, an underhanded fastball that can hit targets over thirty feet away with devastating force, at least if the knife is big enough (about 14" and longer). This throw starts at about where the effective range of your spear throws ends. It is hard to make this throw from, say, 15 feet away if you throw it with much velocity, because you have trouble getting the knifepoint to turn all the way around before it hits the target, but at distances greater than this it becomes progressively easier. With bigger blades, this throw actually hits harder from 30 feet than it does from half that.

If you fall in love with the long-range underhand, you will probably want to make the back end of your knives just a little heavier than you would for spear-style throwing alone. This is because we actually *want* the knife to rotate with this throw, although rotate backwards, not forwards as with overhand circus throws. In other words, we want it to revolve because the handle end is heavy, not the point end. The only effect balancing your knives in this way will have on your spear throws is to make them hit a little harder, though the heavier handle will somewhat paradoxically cause fewer of them to stick in, because the knife will have to support more weight when it is trying to stay in the target and will thus slip out more easily (one reason why you shouldn't just always judge yourself by whether or not you get a stick). After you become more advanced, it is advisable to twist your fingers lightly as you release this throw, to put some spin on it. Spin helps stabilize the