

ENCYCLOPEDIA OF EXPLOSIVES AND RELATED ITEMS

PATR 2700

VOLUME 7

BY

BASIL T. FEDOROFF & OLIVER E. SHEFFIELD

ASSISTED BY

SEYMOUR M. KAYE & MANAGEMENT SCIENCE ASSOCIATES



U.S. ARMY RESEARCH AND DEVELOPMENT COMMAND
TACOM, ARDEC
WARHEADS, ENERGETICS AND COMBAT SUPPORT CENTER
PICATINNY ARSENAL
NEW JERSEY, USA

1975

Copies of the "Encyclopedia of Explosives
And Related Items" can be obtained by requesting CD ROM
from the:

National Technical Information Service
(formerly Clearinghouse)
US Department of Commerce
Springfield, Virginia 22151

1-800-553-6847 USA only
703-605-6000
www.ntis.gov/FCPC

The contents of these volumes are UNCLASSIFIED

The distribution of these volumes is UNLIMITED

Neither the US Government nor any person acting on behalf of
the US Government assumes any liability resulting from the use or
publication of the information contained in this document or warrants
that such use or publication will be free from privately owned rights.

All rights reserved. This document, or parts thereof, may not be
reproduced in any form without written permission of the
Energetics and Warhead Division, WECAC, TACOM, ARDEC, Picatinny Arsenal

Library of Congress Catalogue Card Number: 61-61759

PREFACE

This volume represents a continuing effort to cover comprehensively the unclassified information on explosives and related subjects in the same manner and format as in previous volumes. The reader is urged to obtain the previous volumes and to read both the PREFACE and INTRODUCTION in Volume 1 in order to understand the authors' way of presenting the subject matter.

In preparation for and during the writing of this Encyclopedia, the authors have consulted freely with and have had the cooperation of many individuals who contributed their expert knowledge and advice. This fact is acknowledged throughout the text at the end of the subject item. A listing of many others who have helped in various ways would be impractical.

Dr Julius Roth, principal scientist at Management Science Associates, Los Altos, California, contributed significantly in the literature searching and writing of many of the articles for this volume under Contract DAAA21-73-C-0725. Mr Henry Herman of the Explosives Division assisted with proofreading and literature searching. Others who contributed to the manuscript, by invitation are indicated at the end of the articles.

Dr Raymond F. Walker, Explosives Division Chief, provided the financial support and encouragement to continue this work. Further financial support is expected from the sale of copies to non-governmental agencies and individuals by the National Technical Information Service, US Department of Commerce, Springfield, Virginia 22151.

Although considerable effort has been made to present this information as accurately as possible, mistakes and errors in transcription and translation do occur. Therefore, the authors encourage the readers to consult original sources, when possible, and to feel free to point out errors and omissions of important works so that corrections and additions can be listed in the next volume. The interpretations of data and opinions expressed are often those of the authors and are not necessarily those nor the responsibility of officials of Picatinny Arsenal or the Department of the Army.

This report has been prepared for information purposes only and neither Picatinny Arsenal nor the Department of the Army shall be responsible for any events or decisions arising from the use of any information contained herein.



ADDENDUM

Heptyl, listed in Vol 7 of Encycl, p H64-L and described in Vol 1, pp A441-42 as *N-(2,4,6-Trinitro-N-nitranilino)-trimethylolmethane Trinitrate* is claimed now by Dr Paolo Amat di San Filippo in a letter of June 25, 1975 addressed to the Feltman Research Laboratory Director, to be identical with **Epril** described by him and Dr Michele Giua (who died in 1966) in *Annali di Chimica*, Vol 50, 1381-88 (1960). This claim is not correct because *Heptyl* has the formula

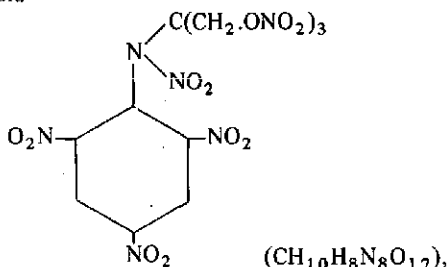

while *Epril* is

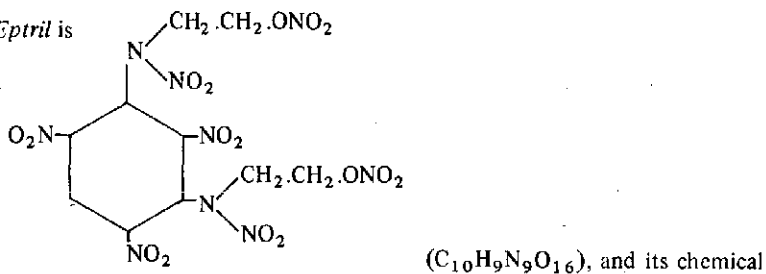

name is *2,4,6-Trinitrophenyl-1,3-dinitraminoethanol Dinitrate*. It was prepd by Di San Filippo by nitrating either 4,6-Dinitrophenyl-1,3-diaminoethanol,

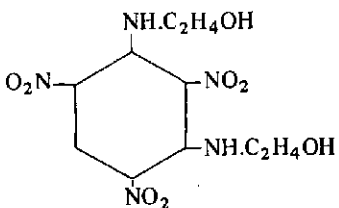
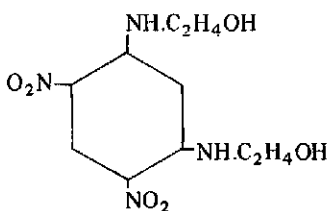

IV

The procedure is described on pp 1382 & 1386 of Ann di Chimica 50. Eprile separated as a greenish-yellow oily-solid which crystallized from ethanol in the form of tiny crystals melting at 123°. Its mw is 511.24 and N content 24.55% (calcd 24.66%). Its explosive properties were not determined

Unfortunately, we did not have the paper of Drs Giua and Di San Filippo at the time 1,3-Di(ethylolamino)-benzene and Derivatives were described in Vol 5, p D1242-R.

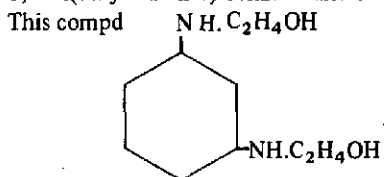

is identical with Phenyl-1,3-diaminethanol which may be considered as the parent compd of 2,4,6-Trinitrophenyl-1,3-dinitroaminoethanol Dinitrate designated as Eprile. The compd prepd by K.F. Waldkötter by nitration of 4,6-Dinitro-1,3-di(ethylolamino)-benzene, described in Recueil de Travaux Chimiques 57 1307 (1938) and in Vol 5 of Encycl is

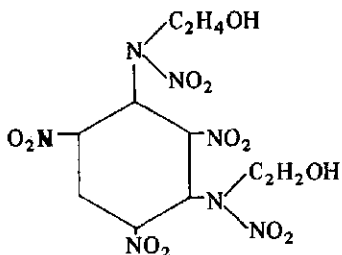

; mw 421.27, N 23.28%; a thick sticky mass, which softened at 30°, decompd violently at 98° and ignited at 230°. It is not identical with Eprile and was not obtd in crystalline form. No attempt was made by Waldkötter to further nitrate this compd called 2,4,6-Trinitro-1,3-bis(N-nitro-β-ethanolamino)-benzene

TABLE OF CONTENTS

	Page
Preface	I
Addendum	III
List of Figures and Illustrations	VIII
Supplement to Abbreviations for Books and Periodicals	X
Supplement to List of Books on Explosives, Propellants, Pyrotechnics and Ordnance Items	XI
Descriptive Text of Encyclopedic Items	
H ₂ to "Hyros" Explosive	H 1 to H 263
IASP to IZZO	I 1 to I 184
J (Poudre de chasse) to Jute	J 1 to J 87
K (Pulver) to KZ	K 1 to K 20
L-Alloy to Lysol	L 1 to L 63
Tables	
Handling Characteristics of Explosives	H 11
Thermodynamic Calculations of Compounds and their NFPA Ratings of Potential Hazard	H 18
Comparison of NFPA Reactivity Rating with Reaction Hazard Index	H 20
Data Source, Reaction Hazard Index, and National Fire Protection Association Reactivity Rating	H 21
Properties of HBX's	H 24
US Specification Requirements for Grades A and B Compositions of HBX	H 25
HBX Composition (Percent by Weight)	H 26
Standard Heats of Formation and Heats of Detonation of Common Explosives	H 41
Standard Heats of Formation and Heats of Detonation of Explosive Mixtures	H 43
Melting Points, Heats of Fusion, Heats of Vaporization and Heats of Sublimation of Common High Explosives	H 44
Heat Conductivity Coefficients and Specific Heats of Common Explosives	H 45
Some Examples of the Use of Group Additivity to Check Experimentally Determined Heats of Formation	H 47
Comparison of Estimated Heat of Formation with Some Measured Since 1969	H 49
Group Values Now Available for State and Class of Compound	H 51

	Page
Tables (Cont'd)	
Measured and Estimated Heats of Formation of Various Compounds at 298°K in kcal/mole	H 52
Heats of Formation of Nitroalkanes	H 54
Group Values for Estimating Heats of Formation of Nitroalkanes	H 55
Heats of Formation of Azo Compounds Measured by Engel and Wood and Estimated by Group Activity	H 56
Group Values for Calculating Heats of Formation of Trans Azoalkanes and Azo Radicals	H 57
Compositions and Properties of HEX-24 and HEX-48	H 73
Solubility of Hexamethylenetetramine in Solvents	H 79
R _f (Relative Movements of Test Sample Thru a Chromatographic Column) for Various Explosives	H 99
Image Dissection Camera Data	H 106
Characteristics of Streak Cameras	H 108
Specifications for Raw Materials Used in HTA-3 Explosive	H 177
Composition of Type I and Type II HT-3 Explosives	H 177
Unreacted Hugoniot Data for Condensed Explosives	H 180
Critical Relative Humidities for Some Explosives and for Ingredients of Explosives and Pyrotechnic Compositions	H 186
Chemical and Physical Properties of Hydrazine Propellant	H 205
Hydrolysis of Plasticizers for NC	H 223
Explosive Nature of Peroxides	H 225
Peroxy Derivatives of Aldehydes and Ketones	H 227
Strength of Sulfuric Acid Required to Give Different Relative Humidities	H 251
Performance Data for Chlorine Trifluoride-Fuel Hypergolic Propellant Combination	H 256
Performance Data for Bromine Pentafluoride-Fuel Hypergolic Propellant Combination	H 256
Performance Data for Hydrogen Peroxide-Fuel Hypergolic Propellant Combination	H 257
Performance Data for Fluorine-Fuel Hypergolic Propellant Combination	H 257
Performance Data for Nitrogen Tetroxide-Fuel Hypergolic Propellant Combination	H 257
Performance Data for Red Fuming Nitric Acid-Fuel Hypergolic Propellant Combination	H 257
Percent Firing of Different Types of Lead Azide versus Distance from the Fuse	I 26
Ignition Temperature Tests of Initiating Explosives by Methods a (Pérez Ara) and b (Datta & Chatterje)	I 27
Ignition Temperature of Nitroglycerin as Determined by Method of Snelling & Storm	I 28
Ignition Temperature of Various Explosives as Determined by Method of Micewicz & Majkowski	I 28
Ignition Temperature of Various Explosives as Determined by Method of Taylor & Rinkenbach	I 28

	Page
Tables (Cont'd)	
Comparison of Impact Sensitiveness Tests	I 41
Impact Sensitivity Data Obtained with the Rotter Apparatus at ARDE	I 41
Comparison of Impact Sensitivity Tests on the Basis of Figures of Insensitivity	I 42
Qualitative Ranking of the Impact Sensitivity of Common Explosives	I 42
Critical Stresses & Thicknesses in Instrument No 2 for Various Explosives	I 51
Charge Thickness for Transition from Fracture to Explosion	I 52
Critical Stresses Obtained in Different Pressures	I 54
Impact Characteristics of Some Common Explosives	I 54
Comparison of Experimental & Theoretical Impulse Constants	I 60
Comparison of Measured and Theoretical Impulse Constants (I_0) for Gas Detonations	I 61
Characteristics of a Typical IMR Propellant	I 64
Materials Used for the Core of an Italian Shell	I 72
Modified Gap Tests of Various Explosives	I 100
Comparison of Approximate and Exact Calculations for Shocked Argon	I 131
Shock Temperatures of Noble Gases	I 131
Important Data Concerning the Most Used Italian Ammunition	I 143
Italian Antitank & Seacoast Guns	I 144
Italian Bombs & Grenades	I 146
Explosive Charges & Fuzes Used in Italian Bombs of WWI	I 147
Italian Mining Explosives with Nitroglycerol	I 158
Italian Pulverulent Mining Explosives with Nitroglycerol	I 159
Italian Pulverulent Mining Explosives without Nitroglycerol	I 159
Italian Mining Explosives Containing Surplus Propellants	I 160
Chemical and Physical Characteristics and Test Methods for Jet Fuels	J 72
Thermal Stability Test Conditions for Jet Fuels	J 75
Russian Blasting Cap Compositions	K 2
Isothermal Decomposition of Explosives at CJ Conditions	K 9
Influence of Kinetics on Adiabatic Explosion Times of PETN	K 9
Kinetic and Thermochemical Parameters for the Decomposition of Molten and Liquid Explosives	K 11
Arrhenius Parameters Based on the Wenograd Test	K 12
Old and Krafzahl (KZ) Trauzl Block Expansion Test Values of Common Explosives	K 18
US Military Specification Requirements for Lead Dioxide	L 9
US Military Specification Requirements for Lead Oxide	L 10
Sales (Millions of Pounds) of Industrial Explosives	L 20
LDX Compositions and Properties	L 21
Detonation Rate of Liquid Methane and Liquid Oxygen Mixtures	L 23
Experimental Detonation Properties of Some Liquid Explosives	L 29
Common Liquid Bipropellant Systems	L 37
Properties of "Exotic" Liquid Bipropellant Systems	L 38
Current Liquid Bipropellant Applications	L 40
Typical Performance Characteristics of LP Rockets	L 42
Loading Density of Various Explosives	L 51
Typical LX Explosive Formulations	L 62

VIII

LIST OF FIGURES AND ILLUSTRATIONS

	Page
Haft Hohlladung (German Adhering or Stick Hollow Charge)	H 2
Panzerhandmine 3 (German Magnetic Antitank Charge)	H 3
Haftmine (German Adhering Mine)	H 3
Extent of Potential Hazard Rating	H 16
Nomograph Linking Decomposition Temperature with Arrhenius Activation Energy	H 19
Example of Use of Reaction Hazard Index with Methane, Ethylene and Acetylene	H 20
Correlation of NFPA Reactivity Rating with Reaction Hazard Index	H 23
Moisture Content Apparatus	H 33
Apparatus for 100°C Vacuum Stability Test	H 33
Kammerminensprengungen in Basaltgestein (Chamber Mine Blasting in Basalt)	H 64
Mechanism of Rotating Prism Photoc Camera	H 105
Diagram of a Simple Drum Camera	H 108
Rudimentary Gun Shaped Like a Bottle	H 122
Hochdruckpumpe (HDP) Supergun	H 163
German Hollow (Shaped) Charges	H 165
Hollow Charge Nose Attachment for AP Bombs	H 166
Apparatus for Determining the Temperature of Ignition	H 169
Steady Plane Shock Front Propagating into Undisturbed Materials	H 179
Alternative Hugoniot Curves	H 179
Transmission of a Plane Shock Wave into a Material of Lower Impedance	H 182
Transmission of a Plane Shock Wave into a Material of Higher Impedance	H 182
Shock Waves Induced in Various Materials by Normally Incident Plane Detonation Waves	H 183
The Rankine-Hugoniot Curve	H 183
Pressure-Volume Hugoniot for 1g/cc TNT	H 184
Definition of Pressure Values Measured on Film Strips	I 1
Diagrammatic Representation of Ignition	I 11
Apparatus for Determining Minimum Energies for Electric-Spark Ignition by Blanc et al	I 11
Lewis & Von Elbe Model of a Minimal Flame in Ignition Process	I 12
Schematic Illustration of Source Energies and Critical Source Temperatures versus Critical Heating Period	I 13
Relation between Ignition Energy, Mean Firing Current and Critical Heating Period for Electric Fuseheads	I 14
Plot of Energy versus Wire Length for Electric Fuseheads	I 14
Relation between Cross-Sectional Area of Wire and Minimum Critical Energy per Unit Length	I 14
Burning Rate for Various Models of Surface Burning Rates	I 15
Anvil Striker Arrangement, ERL Machine	I 37
Drop Weight Impact Machine, ERL Model, Type 12 Tools	I 37
Rotter Machine Impact Chamber and Anvil-Striker Arrangement	I 38
Bureau of Mines Impact Apparatus Showing Anvil-Striking Pin Assembly	I 38
Picatinny Arsenal Impact Test Apparatus	I 39
Parts of Picatinny Arsenal Impact Test Apparatus	I 40

	Page
Figures (Cont'd)	
Impact on a Layer Density Close to Maximum	I 46
Impact on a Layer of Low Density	I 46
Design of Apparatus and Connection of the Pick-up to the Oscillograph	I 49
Interpretation of Oscilloscope Traces of Pressure Pulses	I 49
Average Pressures upon Fracture and upon Explosion vs Charge Thickness of HMX, RDX, Tetryl and TNT	H 50
Average Pressures vs Charge Thickness for PETN and Trinitrophenol	I 50
Spread of the Measured Pressures upon Fracture and upon Explosion for RDX	I 50
Explosion Frequency vs Impact Energy for Tetryl and RDX and HMX	I 51
Explosion Frequency vs charge Thickness in the Case of HMX for Various Impact Energies	I 52
Time Delay Between Impact and Explosion	I 53
Impedance, Acoustic and Shock Diagram	I 56
Constants for EL 506D as Functions of the Ratio of Foam Neoprene to Target Weights	I 60
Laser Interferometer System	I 112
Relation between the Light Energy Required for Ignition and Temperature for Nitrogen Iodide	I 119
Italian Cartridge with Igniter Tube	I 151
Italian Cartridge Bag	I 151
Idealized Projectile Types	J 1
Cross Section of Open Hearth Furnace Tap Hole Showing Jet Tapper in Position for Firing	J 76
Types of Jet Propulsion Engines	J 78
Comparison of Turbojet & Turboprop Engines	J 79
Schematic of Ramjet Engine	J 80
Schematic of Pulse Jet Fitted with Flow-Check Valves	J 81
Comparison of Performance Parameters of Jet Engines	J 82
Line Wave Generator of the Manifold Type	L 17
Line Wave Generator of Sheet Explosive	L 17
Line Wave Generator of Warped Sheet of Explosive	L 18
Space-Time Representation of Initiation Behavior of Nitromethane	L 31
Scoop Loading of Explosive Charges	L 48
Charging Plate Loading of Explosive Charges	L 49
Detonator Loading Tool	L 49
Tool for Direct Loading of Component	L 50
Nomograph of Loading Pressure and Density	L 51
Vacuum Pressing Apparatus	L 53
Hydrostatic Pressing Principle	L 54
Isostatic Pressing Principle	L 54

SUPPLEMENT TO THE
LIST OF ABBREVIATIONS FOR BOOKS AND PERIODICALS
GIVEN IN VOL 1, pp Abbr 66 to Abbr 76; VOL 2, pp XI to XII;
VOL 3, pp XII to XIII, and VOL 4, pp XLVII to L

- | | |
|----------------------------|--|
| Blomquist OSRD 4134 (1944) | A.T. Blomquist, "Certain Aliphatic Nitramines and Related Compounds", OSRD 4134 (Nov 1944) |
| Bowden & Yoffe (1952) | F.B. Bowden & A.D. Yoffe, "Initiation and Growth of Explosion in Liquids and Solids", Cambridge Univ Press, Cambridge, Gt Britain (1952) |
| Bowden & Yoffe (1958) | F.P. Bowden & A.D. Yoffe, "Fast Reactions in Solids", Academic Press, New York (1958) |
| 5th ONR SympDeton (1970) | "The Fifth Symposium (International) on Detonation", Pasadena, California, 18-21 August 1970, 512 pp |
| Hackh's (1972) | J. Grant, "Hackh's Chemical Dictionary", McGraw-Hill, Hightstown, NJ, 4th edn (1972), 738 pp |

**SUPPLEMENT TO THE
LIST OF BOOKS ON EXPLOSIVES AND PROPELLANTS
GIVEN IN VOL 1, p A676; VOL 2, pp C215 to C216; VOL 3, pp XIV to XV
VOL 4, pp LI to LV; VOL 5, pp XIV to XV; and VOL 6, p X**

E.J. Hoffschmidt & W.H. Tantum IV, "Second World War – German Combat Weapons", WE Inc, Old Greenwich, Conn, Vol 1 (1968)

W.H. Tantum IV & E.J. Hoffschmidt, "Second World War – Japanese Combat Weapons", WE Inc, Old Greenwich, Conn, Vol 2 (1968)

Anon, "Principles of Explosive Behavior", **AMCP 706-180**, Engineering Design Handbook, US Army Materiel Command, Washington, DC 20315 (April 1972)

Brodie, Bernard & Fawn, "From Crossbow to H-Bomb", Indiana University Press, Bloomington (1973), 320 pp

Collective, "The Problem of Chemical and Biological Warfare". A study of the Historical, Technical, Military, Legal and Political Aspects of CBW and Possible Disarmament Measures. Stockholm International Peace Research Institute, Almqvist & Wiksell, Stockholm and Humanities Press, NY (1973)

Vol 1. "The Rise of CB Weapons, 396 pp

Vol 2. "CB Weapons Today", 420 pp

Vol 3. "CB and the Law of War", 194 pp

Vol 4. "CB Disarmament Negotiations, 1920–1970", 412 pp

Vol 5. "The Prevention of CBW", 286 pp

J. Quick, "Dictionary of Weapons and Military Terms", McGraw-Hill, NY (1973), 515 pp

"Blaster' Handbook", Explosives Division, Canadian Industries Limited, 630 Dorchester Blvd W, Montreal, Quebec (1973), 545 pp

Anon, "Explosives Trains", **AMCP 706-179**, Engineering Design Handbook, US Army Materiel Command, 5001 Eisenhower Ave, Alexandria, Va 22304 (Jan 1974)

Anon, "Design of Ammunition for Pyrotechnic Effects", Engineering Design Handbook, US Army Materiel Command, 5001 Eisenhower Ave, Alexandria, Va 22304 (March 1974)

RUSI & Brassey's "Defence Yearbook 1974", Praeger, NY (1974), 338 pp

M.A. Cook, "The Science of Industrial Explosives", Graphic Service & Supply, IRECO Chemicals, Salt Lake City, Utah (1974), 449 pp

R.W. James, "Propellants and Explosives", Noyes Data Corp, Park Ridge, NJ (1974), 363pp

R.T. Pretty & D.H.R. Archer, Edits, "Jane's Weapon Systems", Franklin Watts Inc, New York, NY (1974-75), 852 pp

Major F.W.A. Hobart, Edit, "Jane's Infantry Weapons", Franklin Watts Inc, New York, NY (1975), 860 pp

H

ENCYCLOPEDIA of EXPLOSIVES and RELATED ITEMS

Volume 7

H₂. Designation of N-Acetylamidomethylhexamethylenetetraminemononitrate described in Vol 1, p A54-L

H2 Kongo or Type 98 Explosive. Japanese WWII explosive consisting of Trinitroanisole 70 & Hexanitrodiphenylamine 30%. It was used in bomb auxiliary boosters, sea mines & depth chges
Ref: Dept of the Army Tech Manual **TM9-1300-214** and Dept of the Air Force Tech Order **TO 11A-1-34**, "Military Explosives", Washington, DC (1967), p 8-3

H-4. The composition of this solventless Ballistite in the form of 0.869 x 0.262 x 16 inch sticks is as follows: NC/NG/DNT/Ethyl Centralite/potassium sulfate 58.00/30.00/2.50/8.00/1.50%

This propellant was used in US Ordnance rockets

Ref: Cal Tech Lab Program **209**, "Investigation of the Dry Extrusion of Solvent Prepared H4 Propellant", Status Rept **1-6** (12 Jan 1945 – 16 June 1945)

H-5. An American rocket propellant consisting of: NC/NG/Et Cent/DNT/K₂SO₄/triacetin/Pb stearate (added) 58/20/8/2.5/1.5/10%/0.5% NC (13%). Its burning rate is 0.3 to 0.8 inches per second for 1000 to 4000 psi at 122°F. The burning rate of a Russian powder examined at the same time was the same at 1000 psi, but 10-15% faster at 4000 psi

Refs: 1) OSRD of NDRC Div 3, Sec H, Final Rept Series P, No 10.2 (1945), p 45 2) W.E. Campbell Jr & L.H. Brown, Aerojet Rept **194** (1946), p 12

H-6 Explosive. A grey castable expl compn contg: RDX 45, TNT 30, Al 20, D-2 Comp 5 and 0.5% CaCl₂ added; mw ca 93, OB to CO₂ -66%; density 1.71 to 1.74; Ballistic Mortar Test for Power 135% TNT; Blast Effects, % TNT: In Air 127% (Shock) & 138% (Impulse); Under Water: 118% (Shock) and 154% (Bubble); Brisance by Sand Test 49.5g sand crushed vs 48.0g for TNT; Detonation Rate 7191m/sec at d 1.71, vs 6825 for TNT pressed

at 1.56; Explosion Temp 610° (min) in 5 sec; Fragmentation Test in 90mm HE, M71 Proj, No of fragments 714 vs 703 for TNT; Friction Sensitivity – unaffected; Gas Volume 733cc/g, vs 730 for TNT; Heat of Combstn 3972cal/g; Heat of Expln 923cal/g; Heat Test at 100° – % loss in 1st 48 hrs 0.78cc, no loss in 2nd 48 hrs and no expln in 100 hrs; Hygroscopicity sl higher than for TNT; Impact Sensitivity – same as for TNT; Rifle Bullet Sensitivity – more sensitive than TNT; Sensitivity to Initiation – min priming chge less than for TNT; Storage – dry

Usage – primarily in HE charges (Refs 1, 4 & 6)

Preparation – same method as described under **HBX**. US Military Specification requirements and tests are described under **HBX**. Its Spec is MIL-E-22267A (31 May, 1963)

Refs: 1) S.D. Stein, G.J. Horvat & O.E. Sheffield, "Some Properties and Characteristics of HBX-1, HBX-3 and H-6 Explosives", PATR **2431** (June 1957) 2) O.L. Rogers, "Relative Effectiveness of TNT, Comp B and H-6 as Mine Fillers", APG report on Proj TS1-200 (Oct 1959) 3) H. Herman, PA Feltman Res & Engrg Lab, Instrumentation Rept **268-59** (April 1960) 4) Anon, Navord **2986** (1961) Sect D.2 5) L.A. Potteiger, NWL Rept **1930** "Alternation of Mech Props of 16 Metals by Explosively Induced Stress Waves" (July 1964) 6) O.E. Sheffield, **AMCP 706-177**, pp 146-149 (Jan 1971)

H-16. Code name for 1,9-Diacetoxy-2,4,6,8-tetra-nitro-2,4,6,8-tetrazanonane or 1,9-Diacetoxy-1,3,5,7-pentamethylene-2,4,6,8-tetranitramine. See Vol 5 of Encycl, p D1118-R

H19. A designation for 4-N-Methyl-2,6-N-dinitro (Bicyclo)-pentamethylenetetramine

H21 or MSX. Designations for 1-Methyl-6-acetoxy-trimethylene-1,3,5-trinitramine

Haber, Fritz (1868-1934). German chemist and Nobel prize winner. Discoverer of synthetic method for catalytically producing ammonia from nitrogen and hydrogen. This discovery

enabled Germany to manufacture explosives in WWI despite the naval blockade. Did considerable work in gas warfare

Refs: 1) Hackh's Chem Dict, Blackiston, Phila (1944), p 394 2) R. Hanslian, SS 29, 59 (1934)

Hackh & McLeod Explosive. A preliminary investigation of the effect on the explosion props of 50/50 Amatol of incorporating with it Nitronaphthalene & benzaldehyde, in accordance with a process set forth in the patent application of Messrs Hackh & McLeod, showed conclusively that the addn of 10% alpha Nitronaphthalene ("catalyst") & 2% benzaldehyde ("promoter") renders the Amatol less sensitive to friction, less brisant, and undesirably insensitive to initiation to detonation

The results fail to substantiate the claim of the inventors and in no way bear out the theory that the efficiency of nitroexplosives can be increased by the addn of nonexplosive materials having specified intra-atomic distances

Ref: J.D. Hopper, PATR 731 (April 1936) & PATR 743 (July 1936)

HADN. See Hexamethylenetetraminedinitrate or Hexaminedinitrate in this Vol

Haensoson-bakuyaku or Type 88 Explosive. Japanese WWII expl consisting of Ammonium Perchlorate 75, ferrosilicon 16, wood meal 6 & petroleum 3%. It was used in demolition chges, mines & depth chges

Ref: Dept of the Army Tech Manual TM9-1300-214 and Dept of the Air Force Tech Order TO11A-1-34, "Military Explosives," Washington, DC (1967), p 8-4

NOTE: Compare with Carlit or Karitto described in Vol 2 of Encycl, p C68-L

Haussermann, Carl (1853-1918). German scientist specializing in explosives. In 1891 he developed an industrial method of preparing TNT and recommended its use as a military explosive. *Ref:* C. von Hell, SS 13, 325-27 (1918)

Hafenegger Powder. A mixture patented in 1868 in England consisting of chlorates, sulfur, charcoal and potassium ferrocyanide

Refs: 1) Cundill (1889) in MP 6, 7 (1893) 2) Daniel (1902), p 366 3) Gody (1907), p 263 4) Giua, Trattato 6 (1959), 392

Hafthohlladung. (Adhering or Sticking Hollow Charge). One of the devices consisted of a conical metallic container (filled with 3 lb 5 oz of a HE) to which was attached an elongated apex; serving as a hand grip and contg the exploder pellet (PETN/Wax) and a pull (friction) delay igniter (4½ or 7 seconds). Attached to the base of the conical section was a plywood

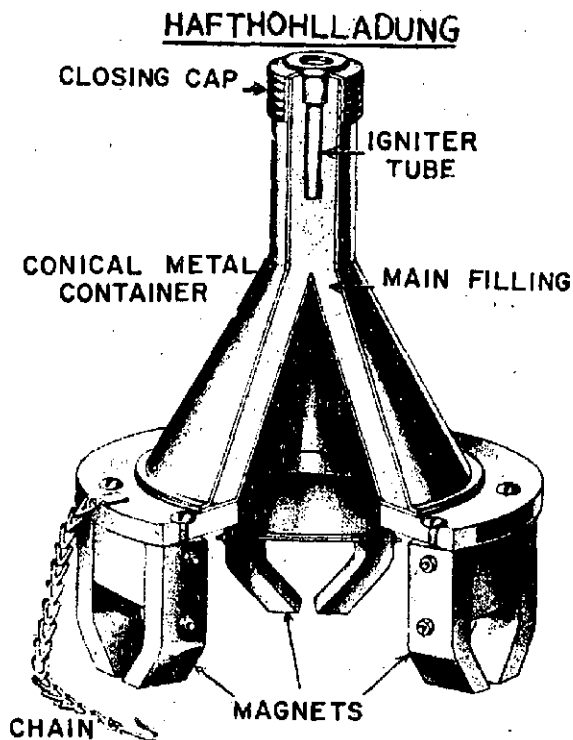

frame-work carrying three powerful horseshoe magnets. A brass chain with a hook was attached to the framework. Total weight 3 kg

The device could be used either as a hand grenade or as a land mine. In the first case the cord of the friction igniter was pulled off and the grenade thrown against the approaching vehicle. In the second case, the device was buried in the ground, close to the surface, with the magnets up and with the igniter cord attached to the ground. At the approach of a vehicle the magnetic attraction caused the grenade to jump towards some iron or steel part and attach itself to it. Simultaneously the cord was pulled, thus setting off the explosive train consisting of delay igniter, exploder and main charge (Ref 2) It was claimed that this

charge could penetrate as much as 110mm of armor (Ref 1, pp 323-4)

Another magnetic antitank charge is described in Ref 1, pp 262-3 under the name of Panzerhandmine 3. It consisted of a bottle-shaped cardboard container with 2 1/3 lb of hollow charge (TNT or RDX/TNT). Three pairs of magnets were mounted at the bottom of the bottle, and a 7½ sec friction igniter was located in the neck of the bottle. Total weight of the device was 8 lb

The device was apparently designed to be placed by hand on the tank and the igniter pulled after it has been positioned. If the target was of non-magnetic material such as wood, the charge could be attached by means of 3 spikes located at the bottom of the device

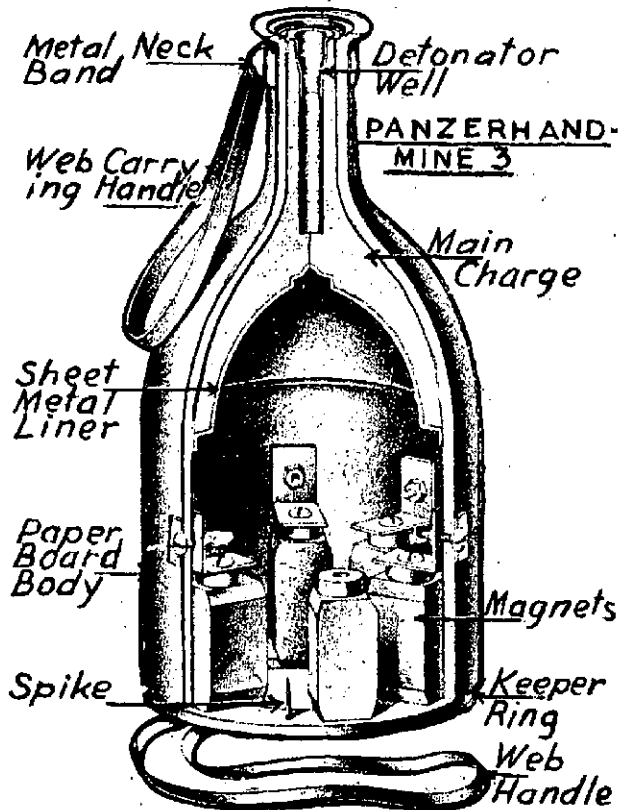

In another type of adhering (sticking) anti-tank hollow charge there were no magnets but a sticky pad (located at the wide part of the conical body) served for attaching the charge to a tank (Ref 1, p 324)

Refs: 1) Dept of the Army Manual TM 9-1985 2 (1953), pp 262-3 & 323-4 2) H.H. Bullock, Pic Arsn, private communication 3) PATR 2510 (1958), pp Ger 85-R to Ger 87-R

HAFTMINE

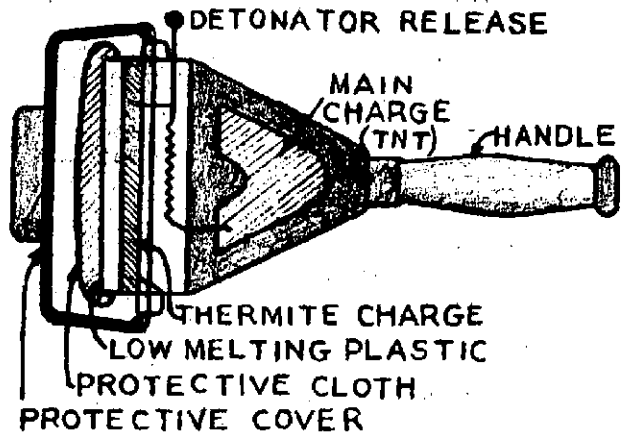

Haftmine (Adhering Mine). An antitank, hollow charge device consisting of a conical container (filled with HE), provided with a flat top and a handle. The wide portion of the cone was covered with a layer of a low melting colophony-oil plastic-resin (m p ca 50°) retained on the surface by means of an open mesh cloth. In back of the flat top, which consisted of sheet metal, was placed a thermite-type charge (Mg + Al + KClO₃) and in back of the latter a time fuse. The operator hid in a hole and, at the approach of the tank, ignited the fuse which, in turn, ignited the thermite. Just as soon as the heat of the thermite melted the resin, the device was struck (by the operator) to the bottom armor plate of the tank. At the same time the heat of the thermite set off the detonator and this in turn initiated the main charge

This device was in an experimental stage when the war terminated

Ref: 1) E.E. Richardson et al, CIOS Rept 25-18 (1945), pp 23-5 2) PATR 2510 (1958), p Ger 87-L & R

Hahn's Explosive. A cheap explosive mixture prepared as follows: Burnt lime was dissolved in raw, odorless nitric acid so as to produce a clear transparent fluid resembling petroleum jelly. This fluid was diluted with 1 to 5 parts of water according to the desired explosive power, and then mixed with a powdered cellulosic material such as peat, sawdust, etc, until a consistant mass was obtained. After giving this mass any suitable form, it was dried and used as a

commercial explosive, eg in rock blasting. It was found to be a powerful explosive insensitive to shocks, friction, or pressure

Ref: M. Hahn, USP 1751326 (1930) & CA 24, 2605 (1930)

Hahn's Powder. One of the chlorate explosives in which sensitivity of the powder due to the presence of $KClO_3$ was reduced by the addition of spermaceti: $KClO_3$ 61/ Sb_2S_3 28/Charcoal 3 & spermaceti 8%. It was patented in England in 1867 and used in primers

Refs: 1) Cundill (1889) in MP 6, 8 (1893)
2) Daniel (1902), 366 3) Gody (1907), 263
4) Pérez Ara (1945), 206

Haid, August (1886-1963). Ger scientist, formerly director of Chemisch-Technischen Reichsanstalt. Author of numerous papers on explosives, some of them in collaboration with H. Kast, H. Selle, A. Schmidt or H. Koenen

Ref: H. Koenen & P. Dittmar, *Explosivst* 1963, 54-6 (Obituary, portrait and list of publications)

Haid, Becker and Dittmar Stability Test (Designed for high explosives). 42g of powdered explosive, previously dried over phosphorous pentoxide, is introduced through a side tube into a glass vessel connected with a manometer which is in the form of a U-tube and contains mercury covered with a layer of paraffin oil. The glass vessel is also fitted with a side tap. The ensemble is heated at 75° for several hours and pressures are recorded in mm of Hg as a function of time. The steeper the pressure-time curve the less stable is the explosive

Ref 2 gives curves for principle explosives as well as for smokeless powders

Refs: 1) Reilly (1938), 92, 2) A. Haid, F. Becker & P. Dittmar, *SS* 30, 66 & 105 (1935)

Haishokuyaku. Japanese WWII explosive consisting of Ammonium Perchlorate 77, RDX 17, silicon carbide 1.5 & paraffin 4.5%. It was used in demolition blocks

Ref: Dept of the Army Tech Manual TM9-1300-214 and Dept of the Air Force Tech Order TO11A-1-34, "Military Explosives," Washington, DC (1967), p 8-3

Hake Effect. Some industrial explosives, even when made of normal consistency, are subject under certain conditions to a change in storage, by which they become very insensitive. Quinan (Ref) called this the "Hake Effect" in honor of C. Napier Hake, the late Inspector of Explosives for the State of Victoria, Australia

Mr. Hake was the first man of science outside the ranks of Dynamite makers to make a study of this curious & interesting observation. If a small percentage of Blasting Gelatin that has become insensitive be reworked & mixed with a large percentage of a fresh lot, it will infect the mass, and the remade Blasting Gelatin will soon undo the change. Something more than a mechanical effect is involved; in fact, an obscure form of catalytic action seems to be indicated

There are so many unknown factors involved in the "Hake Effect" that it is impossible to take them all into account. One of these is the condition of storage, especially the temp. If a Gelatin of normal consistency & sensitiveness has been stored in a comparatively high temp and is subjected for a few months to a low temp, it seems to develop the "Hake Effect" very promptly. On the other hand, a Gelatin which threatens to develop this effect may show normal sensitiveness at least for a time if transferred to a warmer climate

Ref: W.R. Quinan, "High Explosives," Critchley Parker, Melbourne, Australia (1912), pp 27-29. See also Aging of Dynamites in Vol 1, pp A110-R to A112-L)

Halakite. An explosive submitted during WWI to the Fr & Brit authorities, consisting of Cordite mixed with Pb nitrate, Ba nitrate & Pb chromate. It was claimed to be equally effective as an HE and as a propellant
Ref: Marshall, *Dict* (1920), 48

Hale, G.C. (1891-1948). American scientist who served as Chief of the Chemical Department, Picatinny Arsenal (1929-48). After military service Dr Hale was assigned in 1920 to a task group which was sent to Germany for an exhaustive study of the Ger expl industry of WWI. He made numerous inventions, held many patents, and authored extensive publications in the field of military

propellants & explosives. His name has been given to an explosive called **Haleite** because of the important part he played in its development as a military expl

See Ethylenedinitramine in Vol 6, p E238-R & Cyclonite or RDX in Vol 3 of Encycl, p C611

Haleite. See Ethylenedinitramine under Ethylenediamine and Derivatives in Vol 6 of Encycl, p E238-R

Halford-Kistiakowsky-Wilson Equation of State. See Vol 4, p D608, Eqs 23 & 24

Hall (or Will) Powder. Patented in 1863 in England, it contained potassium chlorate 47, potassium ferrocyanide 38 & sulfur 15%
Refs: 1) Cundill (1889) in MP 6, 8 (1893)
 2) Daniel (1902), 366 3) Giua, Trattato 6 (1959), 391

Hall (John) & Sons. Employed since 1875 charges of compressed **Nitrocellulose** in blasting of sandstone and clays and found that such charges were very effective

Ref: Daniel (1902), p 366

Note: Later, compressed Nitrocellulose was used extensively for bursting charges in shells, bombs & mines. As late as WWI nearly all small demolition (called pyroxylinovyive shashki) blocks used in Russia were of compressed pyroxyline. Bursting charges in older models of Whitehead torpedoes also used compressed Nitrocellulose, contg ca 18% water

Ref: Col M.M. Kostevich, Private Communication, (1955)

HALOBIPHENYL DERIVATIVES

2-Halobiphenyl-Nitro Derivatives. The only compds of this class that are reported to be explosive when they are prepd in quantities of over 5g are:

2-Halo-3,5-dinitrobiphenyl, $C_6H_5-C_6H_2(NO_2)_2X$
 mws 278.66, 323.11 & 370.11; N 10.06, 8.67 & 7.57%; mp 115°, 110° & 132° for X = Cl, Br & I. These compds are prepd by diazouzing 3,5-dinitro-2-aminobiphenyl with nitrosylsulfuric acid, followed by treatment with CuX in HX at 0°

Refs: 1) Beil 5, {1762, 1766 & 1769} 2) S. Zaheer & I. Kacker, JIndChemSoc, 32, 491 (1955) & CA 50; 10688 (1956)

2-Chloro-4',5-dinitrobiphenyl has been prepd by the mixed acid nitration of 2-chlorobiphenyl, mp 159°, further nitration may yield small amts of a tetranitro deriv melting at 127°
Ref: G.H. Beauveau et al, JChemSoc (1961) 2749 & CA 56, 3377 (1962)

Haloclastite or **Haloklastit.** Same as **Petroklastite** (Ger): One of the pre-WWI expls used in potash mines and stone quarries: Na-nitrate 69, K-nitrate 5, sulfur 10, coal tar pitch 15, K-dichromate 1%

Refs: 1) Marshall 1 (1917), 89 2) Stettbacher (1933), 111 3) PATR 2510 (1958), Ger 130-L

Halodinitrophenylnitraminoethyl Nitrates. See under Phenylaminoethanol & its derivatives

Halogenated Acetylenes

Mono and di-halogen-substituted acetylenes and their metal salts are very unstable, highly flammable, and many of them are highly explosive:

Acetylene Bromide, Bromoacetylene, Bromoethyne or **Ethynylbromide** (called **Bromäthin** or **Bromacetylen** in Ger). BrC:CH; mw 104.93; colorless gas, bp -4.7°, Q_{vap} 58cal/g, d 4.68g/l at 0° & 1 atm; sl sol in w; sol in eth & dil HNO₃; toxic. Prepd from alc KOH & brominated hydrocarbons, also Br₂C:CHBr & HgCl₂ & KCN to give the mercuric salt (Ref 1).

Addnl thermodynamic data (see Acet Chl for definitions): (H₀-E₀°)/T 9.702, (F₀-E₀°)/T 49.52; c_p^0 13.31 cal/° mole & S° 59.22 eu (entropy units) (Ref 10)

It is pyrophoric and w solns give off O₃ and phosphoresce. Hg (C:CBr)₂ darkens and explodes above 153°. It also explodes with shock

Acetylene Chloride, Chloroacetylene, Chloroethyne or **Ethynyl Chloride**, (called **Chlor-äthin** or **Chlor-acetylen** in Ger), ClC:CH; mw 60.48; colorless gas, bp-29.6° Q_{vap} 89 cal/g (at bp); d 2.0 (Ref 4). Sol in w & alc (water soln gives off O₃ and glows in dark), nauseating odor and probably anesthetic if inhaled. Prepd from Cl₂C:CHCl & alc KOH (Ref 6); Cl₂C:CHOOH & Ba(OH)₂; CHCl:CHCl & KOH, HgCl₂ & NaCN to give Hg(C:CCl)₂ which gives acetylene chloride on heating with NaCN and KOH under N and drying with H₂SO₄-P₂O₅ (Ref 2).

Addnl thermodynamic data: H₀-E₀°/T 9.442,

$F_o-E_o^{\circ}/T$ 46.96 c_p° 13.31 (all in cal/deg mol)
 S_o° 56.40 eu, H_o° , F_o° , c_p° & S_o° are respectively
 standard heat of formation, stand free energy of
 form; heat capacity & std entropy. E_o° is heat of
 formation of a perfect gas. at abs zero (Ref 10)

Acetylene chloride behaves very unpredictably
 It is spontaneously flammable in air and it
 explodes when heated in air or shocked. On
 pyrolysis it gives off the very toxic phosgene
 (Ref 8). An attempt at defining its explosion
 limits is made in Ref 2

The following metal salts of acetylene
 chloride are known (Ref 2): 1) Hg (C:CCl)₂. See
 above for prep; mp 185°, explodes 195° 2) Ag-
 C:CCl, prepd by treating acetylene chloride with
 an ammoniacal Ag soln to obtain a very unstable
 white pptate which darkens in air. It explodes
 on shocking even under water 3) Cu C:CCl,
 prepd by treating acetylene chloride with ammo-
 niacal. CuCl; shock sensitive

Dibromoacetylene or Dibromoethyne (called
Dibromäthin or Dibromacetylen in Ger) BrC:CBr;
 mw 183.82; colorless liq, mp ~ -24°, bp ~ 76°,
 d ~ 2, ins in w; sol in org solns; toxic; vap
 inhalation produces violent headaches & dizziness.
 Prepd by action of alc KOH on Br₂C:CHBr or
 aq KOBBr on acetylene (Ref 3). It is very unstable
 and will explode in N₂ or CO₂ containing traces
 of O₂; also explodes on heating.

Dichloroacetylene or Dichloroethyne (called
Dichloräthin or Dichloracetylen in Ger), ClC:CCl;
 mw 94.92; colorless liq, mp -66 to -64°, bp 32
 to 33° (748mm); sol in Et₂O & CCl₄; ins in
 w. Prepd by passing hot Cl₂C:CHCl over KOH
 at 130° (Ref 4). Explodes on exposure to air
 and on heating to over 130°

Diiodoacetylene or Diiodoethyne (called
Diiodäthin or Diiodacetylen in Ger). IC:CI; mw
 277.82; yellowish rhombic crystals (from ligroin),
 mp 81°; bp 80 to 100° (decomp); sl sol in
 cold ligroin; v toxic—attacks mucous mem-
 branes. Prepd by action of alc KOH or NaOEt
 on C₂I₄, ClC:CIH or C₂I₂Cl₂; by decomposing
 C₂I₄ in sunlight; from C₂H₂+KI+KOCl or
 KOBBr in w; from C₂H₂ or NaC₂H or CaC₂+
 I₂ in liq amm (Ref 5). Addnl thermodyn data
 (at 373:15°K)—see Acetylene Chloride for
 definitions— $H_o^{\circ}-E_o^{\circ}$ 13.90, $F_o^{\circ}-E_o^{\circ}$ 64.75, cal/
 mole c_p° 17.44 cal/deg mole, S_o° 78.65 eu.
 (Ref 9). Explds on grinding, explodes on
 heating above 120°, decomp at lower temps
 when heated in light

**Iodoacetylene, Acetylene Iodide, Ethynyl-
 iodide, or Iodoethyne** (called **Iodäthin or
 Iodacetylen** in Ger). IC:CH; mw 151.93, bp
 32°, one of the products of the reactn of
 BrMgC:CH with I₂ (Ref 6)

Refs: 1) Beil 1, 245 (106) & {919} 2) Beil 1,
 45, (67), [221] & {917} 3) Beil 1, 246, [222]
 & {919} 4) Beil 1, (606), [222] & {918} 5)
 Beil 1, 246, (106), [222] & {919} 6) Beil 1,
 [222] 7) Beil 1, 248, [223] & {922} 8)
 Sax (1968), 373 9) J. Ziomek & E. Cleve-
 land, JChemPhys 17, 578 (1949) & CA 43,
 8838 (1949)

Bromo-1-methylacetylene or Bromopropyne
 (called **2-Brom-1-methylacetylen or Brompro-
 pin** (1) in Ger). CH₃C:CBr; mw 118.96, bp 65°,
 d 1.35 at 25°, RI 1,4448. Prepd by passing
 Me-acetylene into alk KOBBr at 0°; from 1,1,2-
 tribromopropane heated on a steam bath with
 alc KOH in an atm of hydrogen. If inhaled it
 causes severe headaches. The pure material
 self-ignites in air

Ref: Beil 1, [223] & {922}

HALOGENATED AMINES or HALOGENATED AMIDES

Organic compounds containing halogen atoms
 attached to the nitrogen. A large number of
 such compounds were prepd by treating amines
 with hypochlorites. Some of these compounds
 are explosive:

N,N-Dichloroformamide, HCONCl₂; mw 113.93,
 N 12.30%; yellowish-red liquid which may be
 prepd either by the action of hypochloric
 acid or chlorine on formamide dissolved in
 water and cooled with ice-salt mixture. It is an
 explosive which already starts to decompose
 slowly at 0°. When brought to room temperature,
 it explodes spontaneously within a few seconds
 (Refs 1 & 4)

**N,N-Ethylidichloroformamide, N,N-Dichloro-
 propionamid**, mw C₂H₅CONCl₂, mw 141.99, N 9.87%
 bp 88-89° at 762mm. It was prepared by
 Rideal (Ref 3) and claimed to be a powerful
 explosive suitable as a replacement for NG

The following explosive derivatives of
 aliphatic diamines were prepd by Chattaway
 (Ref 2):

**Ethylenetetrachloraminodiamine, or N,N,N',N'-
 Tetrachloroethylenediamine**; Cl₂NCH₂CH₂NCl₂;
 mw 197.88, N 14.16%, yellow liquid, mp 4-4.5°

bp, 76-78° at 10mm (Ref 5), bp 116° at 50mm (Ref 2), d 1.544 at 20° (Ref 5). Explodes with great violence on heating (Ref 2). Can also be prep'd in $H_2O/Cl_2/NaHCO_3$ soln (Ref. 5)

Ethylenetetrabromodiamine, $Br_2NCH_2CH_2NBr_2$; mw 375.68, N 7.46%; orange-colored crystals, mp about 62° with decomposition, followed almost immediately by a violent explosion (Ref 2)

s-Diacetylenedibromodiamine, $CH_3CONBrCH_2CH_2NBrCOCH_3$; mw 301.98, N 9.28%, pale yellow prisms; mp 150-155°, giving off bubbles of gas and almost immediately exploding (Ref 2)

s-Dipropionylethylenedichlorodiamine, $CH_3CH_2CONClCH_2CH_2NCICOCH_2CH_3$; mw 241.14, N 11.62%; yellow liquid, decomposes almost explosively on heating (Ref 2)

s-Dipropionylethylenedibromodiamine or N,N'-Dipropionyl-N,N'-dichloroethylenediamine, $CH_3CH_2CONBrCH_2CH_2NBrCOCH_2CH_3$; mw 330.04, N 8.49%; flattened pale yellow needles, mp 112°; explodes at 160° (Ref 2)

s-Diphenylacetylenedibromodiamine, or N,N'-Dichloro-N,N'-ethylene-bis-phenylacetamide, $C_6H_5CH_2CONBrCH_2CH_2NBrCOCH_2C_6H_5$; mw 454.18, N 6.17%; pale yellow plates; mp 128°. Explodes at about 150° (Ref 2)

s-Di-m-nitrobenzoylthylenedichlorodiamine, or N,N'-Dichloro-N,N'-ethylene-bis-3-nitrobenzamide, $O_2NC_6H_4CONClCH_2CH_2NCIOC_6H_4NO_2$; mw 427.22, N 13.12%; nearly colorless plates with slight yellowish tint, mp 173°. Stable up to about 220°, but explodes when heated in a flame (Ref 2)

s-Di-p-nitrobenzoylthylenedichlorodiamine, or N,N'-Dichloro-N,N'-ethylene-bis-[4-nitrobenzamide], $O_2NC_6H_4CONClCH_2CH_2NCIOC_6H_4NO_2$; mw 427.22, N 13.12%; nearly colorless plates with slight yellow tint, mp 207°; decomposes at about 215°. Explodes when heated in a flame (Ref 2)

s-Dibenzenesulfonylthylenedichlorodiamine, or N,N'-Dichloro-N,N'-ethylene-bis-benzenesulfonamide, $C_6H_5SO_2NCIC_6H_4CH_2NCISO_2C_6H_5$; mw 413.32, N 6.78%; colorless prisms, mp 113°; starts to decompose at 200°. When heated strongly in a flame it decomposes explosively (Ref 2)

s-Dibenzenesulfonylthylenedibromodiamine, or N,N'-Dibromo-N,N'-ethylene-bis-benzenesulfonamide, $C_6H_5SO_2NBrCH_2CH_2NBrSO_2C_6H_5$; mw 502.22, N 5.58%; pale yellow prisms, mp 134°; decomposes

at 165-175°. When heated rapidly in flame, it explodes (Ref 2)

Di-p-toluenesulfonylthylenedibromodiamine, or N,N'-Dibromo-N,N'-ethylene-bis-toluenesulfonamide, $H_3CC_6H_4SO_2NBrCH_2CH_2NBrSO_2C_6H_4CH_3$; mw 530.28, N 5.28%; pale yellow plates, mp 165°; decomposes beginning at 170° and explodes at about 180° when heated rapidly (Ref 2)

Di-m-nitrobenzenesulfonylthylenedichlorodiamine, $O_2NC_6H_4SO_2NCIC_6H_4CH_2NCISO_2C_6H_4NO_2$; mw 499.32, N 11.22%; pale yellow prisms, mp 198°; decomposes beginning at 220°, explodes when heated in a flame (Ref 2)

Dibenzoyltrimethylenedichlorodiamine, or N,N'-Dichloro-N,N'-propylene-bis-benzamide, $C_6H_5CONClCH_2CH_2NCIOC_6H_5$; mw 337.22, N 8.31%; colorless plates, mp 85°. Explodes when heated above 160°

Refs: 1) Beilstein, 2, (22) 2) F.D. Chattaway, JCS, 87, 381 (1905) 3) J.D. Rideal, Ger 301, 799 & CA 15, 1966 (1921) 4) P.L. Magil, IEC 26, 611 (1934) 5) L.K. Jackson et al, JACS 69, 1539 (1947) & CA 41, 5852 (1947)

HALOGENATED DERIVATIVES OF SULFONAMIDES

The sulfonamides are distinguished by the great readiness with which they form well-crystallized derivatives in which all the amine hydrogen is replaced by halogens, when acted upon by hypochlorous acid at ordinary temperatures. The sulfonchloramides so produced exhibit great stability when compared with other chloramides. Those containing two chlorine atoms attached to nitrogen, melt without decomposition and can frequently be heated considerably above their melting points without undergoing any change, but they explode when heated by direct flame. The tetrachloroamides derived from disulfonamides resemble nitrogen chloride itself in the violence with which they detonate. When similarly heated, the sulfonalkylchloramides do not detonate, but decompose rapidly with evolution of gas. They are used as external antiseptics — "sulfa drugs"

The following explosive sulfonchloramides and their salts were prep'd by Chattaway (Ref 12):

1. Sulfondichloramides and Sulfonalkylchloramides

Benzenesulfondichloramide or N,N'-Dichloro-benzenesulfonamide (called **N,N'-Dichlorobenzosulfamid** in Ger), $C_6H_5SO_2NCl_2$; mw 226.08, N

6.20%; slightly yellowish crystals, mp 76°. When heated rapidly in a flame, explodes feebly (Ref 12). Its anhydrous **Potassium salt**, $C_6H_5SO_2K:NCl$; mw 229.7, N 6.1%, colorless prisms, explodes when heated rapidly at 140-145° and the **Sodium salt**, also called Chloramine B, $C_6H_5SO_2Na:NCl$; mw 213.6, N 6.6%; explodes at 180 to 185° (Refs 1 & 12)

Toluene-o-sulfondichloramide or **N,N-Dichloro-o-toluolsulfonamide** (called **Dichlor-o-toluolsulfamid** in Ger), $C_6H_4(CH_3)SO_2NCl_2$; mw 240.11, N 5.83%; mp 33°. This compound is not listed as an explosive, but its anhydrous **Potassium salt** explodes feebly at 145°, while its **Sodium salt** explodes with some violence when heated to 170-175° (Ref 2 & 12)

Toluene-p-sulfondichloramide or **N,N-Dichloro-p-toluolsulfonamide** (called **N,N-Dichlor-p-toluolsulfamid** in Ger), $C_6H_4(CH_3)SO_2NCl_2$; mw 240.11, N 5.83%; mp 83°, is not listed as an explosive, but its anhydrous **Potassium salt** explodes with violence at 160-165° and the **Sodium salt** (also called Chloramine T) at 175-180°. Large quantities of the Na salt are toxic (Refs 3 & 12)

Nitrobenzene-m-sulfonchloramide, Potassium and Sodium Salts. $O_2NC_6H_4SO_2K:NCl$; mw 274.72, N 10.20%; and $O_2NC_6H_4SO_2Na:NCl$; mw 258.61, N 10.83%. Both anhydrous salts are explosive. The first explodes at 155°, the second at 175° (Ref 12)

Nitrotoluene-p-sulfondichloramide, $H_3CC_6H_3(NO_2)SO_2NCl_2$; mw 285.11, N 9.83%; mp 101°, is not listed as an expl, but its anhydrous **Potassium salt** explodes at 160°. No sodium salt is described (Ref 4 & 12)

Benzene-m-disulfontetrachloramide, $C_6H_4(SO_2NCl_2)_2$; mw 374.04, N 7.49%; mp 128-30°. Colorless, transparent rhombic crystals (from pet eth). When strongly heated the melted substance explodes with a violence recalling the explosion of nitrogen chloride itself (Refs 5 & 12)

Naphthalene-2-sulfondichloramide, $C_{10}H_7SO_2NCl_2$; mw 276.14, N 5.07%; is not listed as an explosive, but its anhydrous **Potassium salt** explodes feebly at 170° and the **Sodium salt** at 180° (Ref 12)

Naphthalene-2,7-disulfontetrachloramide, $Cl_2NO_2SO_2C_{10}H_6SO_2NCl_2$; mw 456.10, N 6.14%; colorless, transparent pyramids, mp 165° (Ref 6). The melted substance explodes with great violence when strongly heated. Its anhydrous **Potassium**, $C_{10}H_6(SO_2K:NCl)_2$; mw 431.40, N

6.49% and **Sodium**, $C_{10}H_6(SO_2Na:NCl)_2$; mw 399.18, N 7.02%, salts are in the form of colorless hair-like crystals, which decompose explosively at 145-150° and 165-170° respectively (Ref 12)

II. Arylsulfonalkylamides

Compounds of this nature are readily produced by the action of an aqueous solution of hypochlorous acid on the sulfonalkylamides. These compounds, when rapidly heated, decompose with the evolution of gas but without explosion. Two examples are:

Benzenesulfonmethylchloramide, $C_6H_5SO_2NCICH_3$
Naphthalenesulfonmethylamide, $C_{10}H_7SO_2NHCH_3$

III. Sulfondibromamides and Sulfonalkylbromamides

Toluene-p-sulfondibromamide or **N,N-dibromotoluene-p-sulfonamide**, $H_3CC_6H_4SO_2NBr_2$; mw 329.01, N 4.26%; orange-colored plates, mp 104°, partially sol in chl f (Ref 7). When heated rapidly it decomposes explosively. Its anhydrous **Potassium** and **Sodium** salts explode mildly at 145-150° (Ref 12)

Toluene-o-sulfondibromamide, $H_3CC_6H_4SO_2NBr_2$; mw 329.01, N 4.26%; orange-colored rhombic plates, sl sol in pet eth, mp 80° (Ref 2). When heated rapidly above its mp it decomposes explosively. Its anhydrous **Sodium salt** decomposes explosively at 135-140° (Ref 12)

Nitrobenzene-m-sulfondibromamide or **N,N-Dibromo-3-nitrobenzene-sulfonamide**, $C_6H_4(NO_2)SO_2NBr_2$; mw 359.98, N 7.78%; orange rhomboids, mp 157° (Ref 8). When heated in flame it decomposes explosively. Its anhydrous **Potassium** and **Sodium** salts decompose explosively when heated
2-Nitrotoluene-p-sulfondibromamide, $H_3CC_6H_3(NO_2)SO_2NBr_2$; mw 374.01, N 7.49%; transparent prisms, sl sol chl f, mp 142-143° (Ref 9). When heated quickly to a high temperature it decomposes explosively (Ref 12)

The rest of the compounds described by Chattaway (Ref 12) do not explode but merely decompose with the evolution of gas

IV. N-Halogen Derivatives of P-Halogen substituted Benzenesulfonamides

Baxter and Chattaway (Ref 13) describe several compounds of this class, some of which are explosive:

p-Bromobenzenesulfondichloramide or **N,N-Dichloro-3-bromobenzene-sulfonamide**,

$C_6H_4BrSO_2NCl_2$; mw 304.97, N 4.59%; mp 106° (Ref 10). It is not listed as an explosive but its anhydrous **Potassium salt** explodes, without melting, at 165° and its **Sodium salt** at 178° (Ref 13)

p-Bromobenzenesulfondibromamide, $C_6H_4BrSO_2NBr_2$; mw 393.87, N 3.56%; mp 132° dec. It is not listed as an explosive but its anhydrous **Potassium and Sodium salts** explode without melting at 193° and 211° respectively (Ref 12)

p-Iodobenzenesulfondichloramide, $C_6H_4ISO_2NCl_2$; mw 351.97, N 3.98%, mp 147° dec, is not listed as an explosive but its **Potassium and Sodium salts** explode without melting at 150° and 185° respectively (Ref 12)

Refs: 1) Beil 11, 48, (13), [28] & {79}
2) Beil 11, 87 3) Beil 11, 107, (29), [63] & 301 4) Beil 11, 112 5) Beil 11, 201 & 454 6) Beil 11, 217 7) Beil 11, 108 & {302}
8) Beil 11, 71 9) Beil 11, 112 10) Beil 11, 58 & (17) 11) Beil 11, (19) 12) F.D. Chattaway, JCS 87, 145 (1905) 13) R.R. Baxter & F.D. Chattaway, JCS 107 1814 (1915)

Halogenation. Incorporation of one of the halogen elements into an organic compound, eg $C_2H_4 + Br_2 = C_2H_4Br_2$. Review articles and books on halogenation are listed below

Refs: 1) E.T. McBee & O. Pierce, IEC 40, 1611-1619 (1948), Halogenation, with 207 refs & in Sept issues of the succeeding years 2) Groggins (1952), 176-265 3) P.B.D. De la Mare & J.H. Ridd, "Aromatic Substitution Nitration & Halogenation," Acad Press, NY (1959) 4) L.R. Belohlav & E.T. McBee, IEC 50, 1015 (1958)

Halogen Azides are described in Vol 1 under **Azides**: BrN_3 , p A525; CIN_3 , p A529; FN_3 , p A536; & IN_3 , p A542. A recent review (Ref 1) gives the preps, chem & phys props of halogen azides, and reactions of metal halogens to give metallohalogenazides. Also discussed are reactions of metal carbonyls & organometallic comps with halogen azides, & stability relations of azides (Ref 1). The heat of decomposition and max flame temp of CIN_3 have been measured recently (Ref 2). They are, respectively, -93.2 kcal/mole and $3380^\circ K$

Refs: 1) K. Dehnike, AngChem (IntnEdEngl, 6, (3), 240 (1967) & CA 66, R 104639

(1967) 2) C. Paillard et al, CR AcadSci Paris, Ser C, 264, 1721 (1967) & CA 68, 6980 (1968)

Halogen-Metal Interconversions with Halogenated Anilines. A highly explosive compound which appears to be **p-N,N-Trilithioaniline** is formed as a by-product in the reaction of BuLi and p-Br-aniline but not o-Br-aniline (Ref 1). More recently this reaction was repeated but no by-product is mentioned (Ref 2)

Refs: 1) H. Gilman & C.G. Stuckwisch, JACS 71, 2933 (1949) & CA 45, 5127 (1951) 2) M.O. Kiwa, NipponKagakuSasshi 84, (3), 272 (1963) & CA 59, 14013 (1964)

Halotetrazole Salts. The hazards heretofore encountered in the prepn of halotetrazoles have been eliminated, and a safe method for diazotizing 5-aminotetrazole has been devised. Several salts of halotetrazoles were prepd, and aside from results of practical importance such as the production of comps of interest as initiator materials, this work may give rise to some important theoretical consideration as to the fundamental chemistry of initiators

Prepns of the following halotetrazoles are described by Gaughran & Kaufman (Ref):
Copper Chlorotetrazole in 74% yield,
Chlorotetrazole in 55% yield,
Silver & Mercury Chlorotetrazole in quantitative yield,
Copper Bromotetrazole in 75% yield,
Bromotetrazole in 70% yield,
Silver & Mercury Bromotetrazole,
Iodotetrazole in about 10% yield.

It was recommended that some of the salts be thoroughly investigated for possible application as initiator materials

Ref: R.J. Gaughran & J.V.R. Kaufman, "Synthesis and Properties of Halotetrazole Salts," PATR 2136 (Feb 1955)

1-Halo-2-vinylacetylenes. Chlorine, bromine & iodine vinylacetylenes can be prepd by the reaction, at 0° , of the halogen in aq KOH with monovinylacetylene (Ref 1). All polymerize in air to form explosive polymers, with the I-comps being the most explosive of the three. Polymerization is also accelerated by UV, ozonides,

benzoyl peroxides, etc. Additional methods of preparation and props of the individual comps are given below:

1-Chloro-2-vinylacetylene, 4-Chloro-1-buten-3-yne, $\text{ClC}:\text{CCH}:\text{CH}_2$; mw 86.52; colorl liq (darkens on air exposure), bp 55-57°, d 1.003 at 20°, RI 1.4663 at 20° (Ref 2); insol in w; sol in chl. Can be prpd by treating $\text{Me}_2\text{NCH}_2\text{CH}_2:\text{CHCl}$ with MeI followed by treatment with base (Ref 5). Can be distilled under nitrogen but residue tends to explode, as does polymer formed in air. Hydroquinone appears to act as a preservative (Refs 2 and 3a)

1-Bromo-2-vinylacetylene or 4-Bromo-1-buten-3-yne, $\text{BrC}:\text{CCH}:\text{CH}_2$; mw 130.97; colorl liq (darkens on air exposure), bp 52-53° at 217mm, d 1.480 at 20°, RI 1.5182 at 20°; insol in w; sol in chl. Can be prpd by reacting Br with $(\text{CH}_2:\text{CHC}:\text{C})_2\text{Hg}$ (Ref 3). The bromopolymer is more explosive than chloropolymer. Bromopolymer formed in the absence of air is not explosive

1-Iodo-2-vinylacetylene or 4-Iodo-1-buten-3-yne, $\text{IC}:\text{CCH}:\text{CH}_2$; mw 177.97; colorless liq (darkens on air exposure) bp 71.5° at 102 mm (Refs 2 & 3), 78° at 125 mm, d 1.887 at 20°, RI 1.5948 at 20° (Ref 2); insol in w; sol in chl. & Et_2O (Ref 4). Can be prpd by reaction of I and vinylacetylene in liq ammonia (Ref 4); the reaction of I and vinylacetylene-MgBr in ether; or I and $(\text{CH}_2:\text{CHC}:\text{C})_2\text{Hg}$ in chl. (Ref 2)
 Refs: 1) Beil 1, {1038} 2) R.A. Jacobsen & W.H. Carothers, JACS 55, 4668 (1933) USP 1,967,864 3) W.H. Carothers et al, JACS 55, 4666 (1933) 3a) Clift & Fedoroff Manual, Vol 2, p F1 (1943) 4) T.H. Vaughn & J.A. Nieuwland, JCS (1933) 741 5) A.T. Babayan et al, DoklAkadNaukArmen, SSR 26, 153(1958) & CA 52, 19902 (1958)

Haloxyline. An Austro-Hungarian explosive invented about 1865. It represents a variety of sulfurless Black Powders such as KNO_3 75.0, charcoal 8.5, wood pulp 15.0 and potassium ferricyanide 1.5%. A similar explosive was patented in 1866 in England (Ref 1)
 Refs: 1) Daniel (1902), 367 2) J. Pepin-Lahalleur, "Poudres, Explosifs et Artifices," J.B. Baillière, Paris (1935), p 287 3) Thorpe's Dictionary 4 (1940), p 463. See also Fehleisen Powder in Vol 6, p F13-L

Halsey and Savage Explosives. Several smokeless powders, containing Ammonium Picrate, were patented in the US in 1896. They were prpd by adding finely pulverized Ammonium Picrate to an aqueous solution of potassium dichromate in such a manner as to form a plastic mass and then slowly adding a concd aqueous solution of potassium permanganate.
No 1 Cannon Powder: Amm Picrate 68, $\text{K}_2\text{Cr}_2\text{O}_7$ 25, KMnO_4 7%. *No 2-Sporting Powder*: Amm Picrate 73, $\text{K}_2\text{Cr}_2\text{O}_7$ 20, KMnO_4 7%. *No 3 Rifle Powder*: Amm Picrate 50, $\text{K}_2\text{Cr}_2\text{O}_7$ 20, KMnO_4 7, Ba or Sr nitrate 23%
 Ref: Daniel (1902) 367

Halstead Arsenal. An Armament Research Center, Kent, England

Halved Cartridge Gap Method. See under Phys Tests in Vol I, p XIV

Hamilton patented in England in 1896 the addition of up to 15% of urea oxalate in order to lower the temperature of explosion of dynamites and smokeless powders
 Ref: Daniel (1902), 367

Hancock's Explosive. A blasting composition patented in 1911 consisting of: KClO_3 16, KNO_3 12, brown sugar 3, $\text{K}_2\text{Cr}_2\text{O}_7$ 3, S 6, charcoal 1, lamp black 1 part
 Ref: W.F. Hancock, USP 995134 (1911) & CA 5, 2724 (1911)

Handhabungssichere Sprengstoffe. Ger for Explosives Safe to Handle and Transport
 Ref: Davis (1943), 347

Handgrenade. A grenade to be thrown by hand. See Grenades

Handling Bombs. See Bombs in Vol 2, p B238

Handling Explosives. The general subject of handling explosives is discussed in Ref 2

Specific info on the handling and storing of common military explosives (taken from Ref 1) is tabulated below

Graphite-filled PVC provides resilient coatings which can leak off dangerous electrostatic charges from explosives & propellants (Ref 3)

Remote control sites for handling explosives capable of withstanding detonations of up to 10 lbs TNT are described (Ref 4)

Refs: 1) NOLR 1111, "Ordn Expl Train Designers Hndbk" (1952) p 2-32 2) S.F. Vaskovskii, "Guide Book for Handling Explosive Materials" (in Russ), Gosudarst Nauch-Tech Izdatel Lit po Geol i Okhrane Nedr, Moscow (1957), 159 pp & CA 52, 16746 (1958) 3) J. Donahue & J. Church, NASA Doc N63-13415 (1963) & CA 59, 15495 (1963) 4) R. Campbell & E. Whitbread, Ind Chim Belge 32, 543 (1967) & CA 70, 59428 (1969)

HANDLING CHARACTERISTICS OF EXPLOSIVES

Explosive	Storage	Precaution	Destroying solution
Mercury Fulminate	Wet	Sensitive to flame and sparks	Saturated sodium thiosulfate
Lead Azide	do	Sensitive to flame and sparks. Forms sensitive copper azide	Ammonium acetate
Lead Styphnate	do	Sensitive to flame and to static electricity	Sodium carbonate
DDNP	do	Sensitive to flame	Cold sodium hydroxide
Tetracene	do	do	
Nitromannite	do		
PETN	do		Hydrolyzed slowly by alkalies
RDX	do	Sensitive mixtures with iron and copper oxides, poison when taken orally	Hot sodium hydroxide
Pentolite 50/50	Dry		
PTX-2	do		
EDNA	do	Forms compounds with metals	
Tetryl	do	Dust explosion hazard (22); contact with skin may cause dermatitis.	Boiling sodium carbonate
Torpex-2	do		
Composition B	do		
Composition A-3	do		
Ednatol	do		
Picric Acid	do	Forms sensitive lead and copper salts	
HBX	do		
Tritonal 80/20	do		
TNT	do	Slightly toxic; reacts with alkalies and ammonia to form sensitive compounds	
Picratol	do		
Explosive D	Dry-wooden containers	When wet reacts slowly with lead and copper to form sensitive salts	
Black Powder	Dry	Particularly sensitive to flame and sparks	

Handy-Andy Riot-Control Cartridge. See E24 (Cartridge) in Vol 5, p E1-L

Hangfire. A brief undesired delay in the functioning of ammunition or blasting charges after initiation. It usually refers to delay in ignition of a propelling chge. This should not be confused with "misfire", when the shot or round does not fire at all. Hangfire is of no great importance when blasting charges are fired individually or when weapons such as cannons are discharged individually. But it could be disastrous if hangfire were to take place in an automatic weapon firing at high speed, for example, in machine guns or anti-aircraft guns (Refs 1, 2 & 4)

Twelve reported hangfires since 1932 are stated to be explainable if it is assumed that the explosives involved deflagrated at a burning rate not exceeding 300 m/sec (Ref 3)

Refs: 1) Marshall 2, (1917), 589 2) Ohart (1946), 67 3) H.C. Grimshaw, Minist of Fuel & Power, Safety in Mines Res Est, Res Rept No 34, 3 (1951) & CA 46, 6385 (1952) 4) OrdTechTerm (1962), 151-L

Hangfire Primers. A hangfire in small arms ammunition (initiated by a blow from a firing pin) can be defined as that condition which exists when initiation of the usual chain of events following the release of the trigger in a loaded weapon, occurs at a rate slower than normal; the definition of hangfire for electrically initiated ammo is similar

A hangfire may be of very short duration or may be several seconds in duration. Hangfire in general can be caused by: weapon defects, slow burning of primer compn and/or a slow rate of ignition or combustion of the propellant chge

In order to measure hangfire of primers, it is necessary to start a chronograph when the primer is initiated and to stop it at the first appearance of the primer flash at the flash hole. This time interval can be considered to be a measure of "primer time", and any significant increase above the average can be considered, to be a primer hangfire

Ref: R.W. Evans, "Design and Development of Tests for Characterization of Primers", Denver Res Inst Final Summary Report (May 1956), pp 23-26 [Contract DA1-23-072-501-Ord-(P)-14]

Hangfire Test. Due to the fact that delay in firing of individual shots (hangfire) in automatic weapons (especially in the case of machine guns firing synchronously with a propellor of an airplane) would bring disastrous results, it is necessary to subject the weapons and ammunition to a special test. This test usually consists of firing 600 rounds, in bursts of 75 rounds each, through a disc rotating at 1800 rpm, the groupings being measured in degrees from the leading edge of the shot nearest the zero mark. For aircraft use, the groupings must not exceed 15°; for other uses 27°

The test may also be conducted in a special "electrostatic hangfire machine", which should give the time between the shots of 0.0014 seconds for aircraft weapons and 0.0025 secs for other weapons

Refs: 1) Ordnance Proof Manual 7-16 (1945) 2) Ohart (1946) 67 71 3) R.W. Evans, "Design and Development of Tests for Characterization of Primers", Denver Res Inst Final Summary Report (May 1956)[Contract DA1-23-072-501-Ord-(P)-14]

Hannan Explosives. F. Hannan in 1882 developed a chlorate expl consisting of K Chlorate 50, K nitrate 24, K ferrocyanide 12, charcoal 10 & paraffin 4%

Refs: 1) F. Hannan, Eng P 5986 (1882) & JSCI 2, 427-L (1883) 2) Cundill (1889) in MP 6, 9 (1893) 3) Daniel (1902), 368 4) Giua Trattato, 6, (1959) 394

Hansen or Hydrogen Ion Concentration Stability Test. Hansen (Ref 2) gives the following test applicable to proplnts, provided they contain not more than 0.5% of CaCO₃: a) Dry ca 50g of ground powder in a vacuum oven at 40° for 8 hrs b) Put 5g samples into each of 8 tubes 16 mm diam & 360 mm long, graduated to 50 ml and provided with glass stoppers c) Place the tubes into a constant temp bath maintained at 110° d) After one hr of heating, remove No 1 tube, cool 1/2 hr in air, and add distilled water of pH 7.0 up to the 50 ml mark. Shake well and determine pH by the quinhydrone method e) Remove the other tubes, one at a time, at intervals of one hr (ie after 2, 3, 4, 5, 6, 7 & 8 hrs of heating) and determine pH of each f) Plot the pH values on graph paper vs time and draw a curve

Stability (K) is determined from the formula:

$$K = 15 - (H) \times 10^4,$$

where (H) is absolute hydrogen ion concentration. For example, if pH is 3.0, then H is 10^{-3} and $K = 15 - 10^{-3} \times 10^4 = +5$, and the powder is satisfactory. If pH is 2, then H is 10^{-2} and $K = 15 - 10^{-2} \times 10^4 = -85$ and the powder does not pass the test

In a modified method, the powder is heated under water at 100° to induce hydrolytic decompn

Refs: 1) L. Metz, SS 21, 186-88 (1926) & CA 21, 1013 (1927) 2) N.L. Hansen, Förh III Nord Kemismötet (Finland) 1926, 227-30 (1928) & CA 23, 4074 (1929)

Hansen-Metz Potentiometric Test at 110° . The following modified Hansen-Metz potentiometric test at 110° is described by da Rocha (Refs): Samples of proplnt are cut to pass a 2 mm sieve and retained on a 0.5 mm sieve. They are dried for 12 hrs under vacuum at $25-30^\circ$ and placed in tubes used in the Bergmann-Junk-Mayerhofer Test (18 ± 1 mm internal diam & 360 mm long). After heating up to 8 hrs, the pH is determined. For an absolute hydrogen ion concentration, H, after 8 hrs of exposure at 110° , the stability is expressed as $K = 15 - H \times 10^4$. Positive K means good stability, while negative K means poor stability

NOTE: Da Rocha proposed the terms *static* and *dynamic* stability determinations. The first term refers to a single determination of the degree of denitration, while dynamic stability is a trend expressing the tendency to denitration of a powder with the time of exposure to 110° from 0 to 8 hrs

Refs: 1) J.P. da Rocha, Anais Assoc Quím Brasil 8, 141-47 (1949) & CA 45, 353 (1951) 2) J.P. da Rocha, Engenharia e Quím (Rio de Janeiro) 3, 191-97 (1951); Bol Quím Peruano 3, No 16, 7-12 (1951) & CA 46, 8373 (1952) 3) J.P. da Rocha, Actas y Trabajos Congr Sudamer Quím 5^o Congr (Lima, Peru) 1, 391-95 (1951) (in Portuguese) & CA 49, 15241 (1955)

Hardingham proposed in 1884 in France, for mining use, cartridges containing dynamite combined either with liquified NH_3 or CO_2 or with flammable liquids such as alcohol, benzene or ether

Ref: Daniel (1902), 368

Hardy's Powders. Several powders were known under this name, for example NaNO_3 60.1, KNO_3 14.1, sulfur 8.1, charcoal 11.6, sugar 4.9, moisture 1.2%

Ref: Daniel (1902), 368

Hargreaves Theory of Aging of Blasting Gelatins. See Ageing of Dynamites in Vol 1 of Encycl, p A110-R

Harlé (Cordeau détonant de mine à la tolite). A French detonating cord used in mining. It consists of a TNT (core) enclosed in a lead tubing of 5.9 mm external diam. Its detonation velocity is 5055 to 5165 m/sec

Ref: M. Dutour, MAF 24, 578 & 583 (1950)

Harpax or Harpago. See under Catapult in Vol 2, p C91

Harpoon Antiship Missile (US Navy). THE NAVY'S HARPOON ANTISHIP MISSILE (McDonnell Douglas) has completed six of twenty scheduled full-scale flight tests following many launchings to test techniques and components (CD, October 1972). Harpoon has been fired successfully in its basic form from aircraft; with a 300-pound, 30-inch booster from surface ships; and from submarine torpedo tubes, with folded wings and booster enclosed in a buoyant capsule

THE MISSILE — propelled by a Teledyne turbojet engine — is 17.5 feet long, weighs 1100 pounds, and carries a conventional warhead. It flies at wave height under midcourse inertial guidance until the radar seeker locks onto the target. The missile climbs for a brief instant near the target, then dives on it

An outstanding feature of the weapon is its adaptability to many launchers and its compatibility with ship and aircraft targeting equipment. These include the Asroc ASW weapon, late-model Terrier and Tartar launchers, and A-7 attack, S-3 ASW, and P-3 patrol aircraft

After the twentieth flight in 1974, a third Defense Council review will make a go-ahead decision on pilot production — an extra step because the Navy, to save costs, was allowed to bypass a prototype competition

Ref: The Common Defense Bull No 392, June 15, 1973

Harries Method of Ozonization of Organic Compounds. See under Ozonization of Organic Compounds

Harrisite. See Composition C-4 in Vol 3, p C485

Harrison Powders (1860). A mining expl consisting of potassium chlorate 70, starch 10, carbon 10 & sulfur 10%. An army incendiary mixt was composed of KClO_3 65, starch 6, carbon 6, sulfur 12, licopodium 2, tar oil & charcoal dust 3%. A patent of 1862 reported an expl consisting of KClO_3 or NaClO_3 56, K ferrocyanide 28, starch 4, sulfur 7 & charcoal 5%

Refs: 1) Cundill (1889) in MP 6, 9-10 (1893)
2) Daniel (1902), 369 3) Giua, Trattato, 6, (1959), 391

Hart Powder (1888). A powder patented in 1888 in England, made by impregnating the grains of KClO_3 with a solution of sugar, or with a liquid hydrocarbon

Refs: Cundill (1889) in MP 6, 10 (1892)
2) Daniel (1902), 369

Harry Diamond Labs. The Army has classified the Harry Diamond Laboratories at Adelphi, Maryland, as a permanent US Army installation. The facility is a corporate laboratory of the US Army Materiel Command, specializing in fuzes, fluidics, special purpose radars, nuclear weapons effects, and other research, development, and engineering for weapons systems
Ref: The Official Magazine of United States Army Logistics, Vol 5, No 2 (Mar-April 1973)

Harvey's Explosive. An initiating composition which was detonated by the addition of a drop of concd sulfuric acid. It contains KNO_3 74.3, sugar 19.2, gallynut 6.5%

Refs: 1) Daniel (1902), 369 2) Giua, Trattato 6, (1959), 400

Hasethrol. A medical name for PETN, which is used as a depressor of blood pressure

Hassia — Chlorat or Spreng — Chlorat. Ger WWI expl consist of K chlorate 65 & combustibles 35%. It was claimed to be comparatively insensitive

Ref: Marshall, Dict (1920), 48

HAST. Abbrev for High-Altitude Supersonic Target

Ref: Maj-Gen J.G. Zierdt, Ordn 58, May-June 1973, 480-82

Haswelite. A British permitted explosive which passed the *Buxton Test* (See Vol 2, p B 394). It contains Am nitrate 59, Ba nitrate 3.5, TNT 12, Na chloride 25.5%

Ref: Marshall 3, (1932), 119

Haubitze. Ger for Howitzer

Hawk. See under Missiles and Glossary of Ord (1959), 146-R

Hawkins. Patented in England, in 1894, a liquid explosive which was used as a fuel in internal combustion engines. A mixture of KNO_3 50.0, sugar syrup 33.4, KClO_3 9.3, and $\text{K}_2\text{Cr}_2\text{O}_7$ 8.3% was dissolved in 300 parts of water and was fed by means of an injector into a combustion chamber of a motor

Ref: Daniel (1902), 369

Hawkins Brothers. Patented in 1896 in England, a mixture of the following approximate composition KClO_3 60 to 64, sugar 30 to 32, wood flour or soot 2 to 4, potassium bichromate 2 to 8%

Refs: 1) Daniel (1902), 370 2) Giua, Trattato 6, (1959), 391

Hawkite. A mining explosive of the Favier type: NH_4NO_3 59 to 63, $\text{Ba}(\text{NO}_3)_2$ 4 to 2, TNT 15 to 17, NaCl 23 to 18%. It has 76-81% of the power of standard 60% Gelignite

Ref: Marshall 3, 119

Hay (Foin in French). Cured grass usually used as animal fodder and in:

Nitrohay (Nitrofoin in French) An explosive, which may be prpd by the nitration of dried and powdered hay. It was patented in England

in 1873 by Trench, Faure and Mackie for use in composite explosives such as Nitrohay + resin + ozocerite, collodion cotton dissolved in a volatile solvent, glycerin and charcoal or soot
Ref: Daniel (1902), pp 522 under Nitrofoin and 773 under Trench

Haylite. British explosive of the carbonite type: NG 25 to 27, NC 0.5 to 1.5, KNO_3 19 to 21, $\text{Ba}(\text{NO}_3)_2$ 19 to 21, wood meal 12 to 14, gelatinized silicic acid 6 to 8, ammonium oxalate 10 to 12%
Ref: Naoúm, NG (1928), 402

Hazards of Detonations (and Explosions). See Detonation (and Explosion), Hazards of in Vol 3, p D5-L

Hazardous Materials. See *Dangerous Materials* in Vol 3, p D6

Hazardous Materials Regulations, Index. A 101 page pamphlet, published as Title 49, Code of Federal Regulations, Parts 170-180 (1972 Revision), Supt of Documents, Govt Printing Office, Washington, DC, 20402, 50¢

Hazards of Detonations (and Explosions). See *Detonation (and Explosion)*, Hazards of in Vol 3, p D5-L

Hazards, Prediction of. D.R. Stull has developed methods of linking thermodynamics and kinetics to the prediction of potential and real hazards arising from exothermic chemical reactions (including explosions). We quote extensively from his publications

"Modern technology has been quite successful in developing tailor-made chemicals to cope with specific problems. However, this effort has also introduced some additional problems since manufacturing and handling experience is frequently inadequate to properly answer questions of hazard. Some way is needed to distinguish hazardous from nonhazardous chemicals, and to establish a measure of the extent of hazard

As technology solves the questions it encounters, new compositions of matter are formulated. These formulations are compounded of two or more chemicals, each of which may present no special hazard but, once mixed, may

be quite hazardous. Here too, some way is needed to select the composition of hazard. Although there are many sorts of hazard, we are concerned here with the risk, danger, or peril resulting from handling or processing a given chemical or a composition of matter

The manufacture and handling of chemicals has generated a body of experience that is useful, as far as it goes. The National Fire Codes segregates hazardous materials into five levels of reactivity ranging from zero, indicating no special reaction hazard, to four, indicating the most severe reactivity hazard. This code lists a degree of reactivity for nearly 1000 chemical materials

For many years the explosive industry has used the drop weight test to gauge reactivity by activating a material placed on an anvil with the energy imparted by a falling weight. Drop weight tests are difficult to interpret since the physical properties and characteristics vary from one sample to the next, but the comparative order of explosives by this test is known. If a sample gives a positive drop weight test, it is hazardous, but a negative test does not necessarily prove lack of hazard. Some of the less sensitive materials require more activation than the drop weight gives. For example, tests are often run in which a No 8 blasting cap, or a 50 g charge of Tetryl are used to provide increasing steps of activation energy

Energy Relationships Within a Molecule

The intrinsic energy of a substance determines if decomposition will be exothermic, and its ability to react exothermically with one or more additional substances. Once initiated, a hazardous compound generates energy. The energy generated may be derived from (1) the release of stored energy in the compound, or (2) a chemical reaction forming more stable products from the atoms in the compound or mixture

An example of (1) above is acetylene that absorbs 54.2 kcal/mole (stored within the molecule) when it is made from its elements: graphite and hydrogen gas. Once decomposition of acetylene starts, the 54.2 kcal of heat is evolved which raises the temperature of the products (graphite and hydrogen gas) to 2898 °K with an accompanying pressure increase if the volume is held constant. Self decomposition is regarded as the primary hazard

An example of (2) above is ammonium nitrate that evolves 87.27 kcal/mole when syn-

thesized from its elements: hydrogen, oxygen, and nitrogen gases. Thus, ammonium nitrate is lower on an absolute energy scale than acetylene. However, once decomposition of ammonium nitrate starts, the decomposition products, nitrogen, water, and oxygen gases, are lower on the absolute energy scale than ammonium nitrate, and -28.2 kcal/mole are released heating the product gases to 1242 °K with an accompanying pressure increase if the volume is held constant

In addition to the energy released by decomposition of a compound, there is the possibility of additional energy release by a secondary reaction with one or more other substances present. In the acetylene example above, the initial decomposition produced graphite and hydrogen gases at a decomposition temperature T_d of 2898 °K. In the presence of oxygen gas, an additional reaction to carbon monoxide and water takes place with further release of energy causing a further increase of temperature and pressure. We have arbitrarily elected to call the latter temperature (with oxygen) the "flame temperature," T_o . As we shall see, these two conditions, self decomposition, and oxidation to the most stable natural products at the flame temperature, are important conditions. We shall use the symbols d for decomposition and o for oxidation" (Ref 1)

After presenting the methods of calculating the requisite thermodynamic quantities Dr Stull suggests the correlations between them and potential hazard ratings shown in Figure 1 (taken from Ref 1)

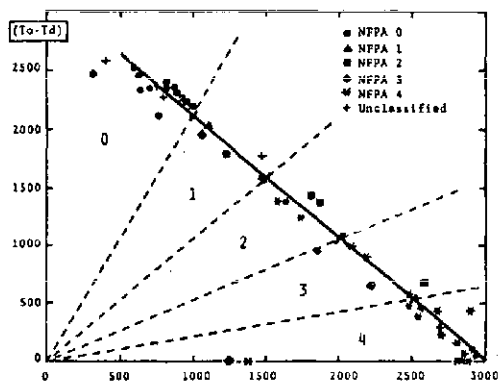

Fig 1 Extent of Potential Hazard Rating T_d

The large numbers (1,2,3 & 4) in this Figure refer to *NFPA Chemical Reactivity Ratings* which are described below:

- 0....Materials which are normally stable even under fire exposure conditions and are not reactive with water
- 1....Normally stable materials that may become unstable at elevated temperatures and pressures, or which may react with water with some release of energy, but not violently
- 2....Materials which are normally unstable and readily undergo violent chemical change, but do not detonate. Includes materials which can undergo chemical change with rapid release of energy at normal temperatures and pressures or which can undergo violent chemical change at elevated temperatures and pressures. Also includes materials which may react violently with water or which may form potentially explosive mixtures with water
- 3....Materials which are capable of detonation or of explosive decomposition or of explosive reaction but which require strong initiating source or which must be heated under confinement before initiation. Includes materials which are sensitive to thermal or mechanical shock at elevated temperatures and pressures or which react explosively with water without requiring heat or confinement
- 4....Materials which are readily capable of detonation or explosive decomposition or explosive reaction at normal temperatures and pressures. Includes materials which are sensitive to mechanical or localized thermal shock

According to Dr Stull examination of Fig 1 reveals the following:

“1. Materials that achieve zero oxygen balance, can detonate, and present the greatest hazard are along the base line

2. The lower third of the chart (up to $T_o - T_d = 1,000^\circ\text{K}$) contains hazardous explosives or materials with an NFPA rating of 3 or 4 (shock sensitive explosive materials). The single exception is hydrogen cyanide with an NFPA rating of 2 (unstable, capable of violent chemical change, but does not detonate)

3. The middle third of the chart (from 1000 to 2000 °K) contains materials that are explosive and have NFPA ratings that range

from 4 (shock sensitive explosives), such as TNT at 1,084°K, through ratings of 2 (unstable materials that do not detonate), to a rating of 1 (normally stable materials that become unstable at elevated temperatures and pressures), such as 4-nitroaniline at 2013°K. Nitroethane with an NFPA rating of 3 is a glaring exception at 1943°K, only 70°K under 4-nitroaniline, whose NFPA rating is 1

4. The upper third of the chart (above 2000°K) contains materials that are almost entirely normally stable with an NFPA rating of 0. The two exceptions are 1,3-butadiene and styrene with NFPA ratings of 2 (normally unstable and can undergo violent reaction, but do not detonate)

Thus, there is a more or less gradual progression from the most hazardous materials in the lower right corner to the "safe", or normally stable materials, in the upper left corner. Of the 50 compounds studied, 44 were rated, and 6 were unrated. The latter, (acetamide, benzamide, hydroquinone, cellobiose, 1-(p-nitrophenyl) ethanol, and phenylacetylene) seem to be fairly placed in the chart. The four exceptions mentioned, (hydrogen cyanide, nitroethane, 1,3-butadiene, and styrene) demonstrate that individual peculiarities will cause certain materials not to follow the general pattern exactly. A line was drawn by eye from $T_d = 3000^\circ\text{K}$ on the baseline to $T_d = 500^\circ\text{K}$ at $(T_o - T_d) = 2600^\circ\text{K}$ fits the points fairly well. This line was divided into five equal segments, then four lines were drawn from the origin through boundaries of each segment and each segmental area was given an "extent of potential hazard rating" similar to the NFPA Chemical Reactivity Rating"

The results of the thermodynamic calcns and the compounds for which they were made, together with the NFPA ratings are shown in the following Table (taken from Ref 1):

TABLE 1

1.	2.	3.	4.	5.	6.	7.	8.	9.	10.	11.	12.	13.	14.	15.	16.	17.	18.	19.	20.	21.	22.	23.	24.	25.	26.	27.	28.	29.	30.	31.	32.	33.	34.	35.	36.	37.	38.	39.	40.	41.	42.	43.	44.	45.	46.	47.	48.	49.	50.	State 4		* Temperature °K			** Heat in kcal/100 grams			*** Pressure in Atmospheres		
																																																		State 4 ΔH ₂₉₈ kcal/mole	T ₀	T _d	(T _d -T ₀)	ΔH _c	ΔH _d	(ΔH _c -ΔH _d)	P _n	P _d	(P _d -P _n)	
																																																												ΔH _c
1. GLYCOL DINITRATE (4)	C ₂ H ₆ N ₂ O ₆	-58.24(k)	2880	2880	0	-97	-97	0	36.4	36.4	0.0																																																	
2. NITROCELLULOSE 14.14% (8)	C ₇ H ₈ N ₂ O ₁₁	-229.80(s)	2854	2213	641	-114	-66	-48	41.4	27.6	13.8																																																	
3. MANITOL HEXANITRATE (11)	C ₆ H ₈ N ₆ O ₁₈	-154.00(s)	2865	2865	0	-49	-49	0	33.5	33.5	0.0																																																	
4. DIPENTAERYTHRITOL HEXANITRATE (14)	C ₁₀ H ₁₆ N ₆ O ₁₉	-220.00(s)	2944	2806	138	-115	-98	-17	44.0	38.8	5.2																																																	
5. GLYCEROLMONOLACTATE TRINITRATE (15)	C ₆ H ₈ N ₃ O ₁₁	-154.85(l)	2932	2718	214	-125	-94	-31	46.7	37.2	9.5																																																	
6. NITROGLYCERINE (15)	C ₃ H ₅ N ₃ O ₉	-89.00(l)	2859	2859	0	-93	-93	0	34.6	34.6	0.0																																																	
7. POLYVINYL NITRATE (21)	(C ₂ H ₃ NO ₂) _n	-28.58(s)	3011	2564	447	-145	-91	-54	55.4	39.0	16.4																																																	
8. TETRYL (26)	C ₇ H ₅ N ₅ O ₈	+8.00(s)	3097	2673	424	-138	-84	-54	54.6	37.8	16.8																																																	
9. BETA HMX (32)	C ₈ H ₈ N ₈ O ₈	-17.92(c)	2995	2921	74	-119	-100	-19	47.6	41.5	6.1																																																	
10. CYCLONITE RDX (32)	C ₃ H ₆ N ₆ O ₆	+16.90(s)	3003	2932	69	-120	-100	-20	47.8	41.7	6.1																																																	
11. 1,3,5-TRIAMINO-2,4,6-TRINITROBENZENE (32)	C ₆ H ₃ N ₆ O ₆	-36.85(s)	3009	1626	1383	-145	-47	-98	56.4	25.3	31.1																																																	
12. 1,3-DIAMINO-2,4,6-TRINITROBENZENE (44)	C ₆ H ₄ N ₄ O ₆	+8.0 (s)	3091	2195	896	-141	-68	-73	56.2	33.3	22.9																																																	
13. METRIOL TRINITRATE (47)	C ₆ H ₅ N ₃ O ₉	-106.00(l)	2962	2688	274	-135	-97	-38	51.0	39.5	11.5																																																	
14. NITROGUANIDINE (47)	CH ₅ N ₄ O ₂	-21.76(s)	2796	1848	948	-124	-61	-63	49.0	29.7	19.3																																																	
15. ETHYLENEDINITRAMINE (48)	C ₂ H ₆ N ₄ O ₄	-24.70(s)	2929	2542	387	-154	-95	-41	52.5	40.0	12.5																																																	
16. AMONIUM PICRATE (49)	C ₆ H ₆ N ₄ O ₇	-95.0 (s)	2976	1743	1233	-141	-52	-89	53.6	26.1	27.5																																																	
17. 2,4,6-TRINITROANILINE (52)	C ₆ H ₃ N ₃ O ₆	-17.8 (s)	3072	2077	995	-144	-61	-83	56.4	30.5	25.9																																																	
18. 1,2,4-BUTANETRIOLTRINITRATE (58)	C ₄ H ₇ N ₃ O ₉	-95.13(l)	2916	2889	27	-105	-100	-5	40.0	38.5	1.5																																																	
19. AMMONIUM PERCHLORATE (67)	NH ₄ ClO ₄	-70.69(c)	1378	1378	0	-52	-32	0	16.7	16.7	0.0																																																	
20. PICRIC ACID (85)	C ₆ H ₃ N ₃ O ₇	-51.70(s)	3051	2464	587	-130	-72	-58	50.2	32.5	17.7																																																	
21. AMMONIUM NITRATE (100+)	NH ₄ NO ₃	-87.27(c)	1246	1246	0	-35	-35	0	18.2	18.2	0.0																																																	
22. DIETHYLENGLYCOL DINITRATE (100+)	C ₄ H ₈ N ₂ O ₇	-102.0 (l)	2949	2470	479	-144	-91	-53	54.0	38.2	15.8																																																	
23. TRIETHYLENGLYCOL DINITRATE (100+)	C ₆ H ₁₂ N ₂ O ₈	-145.00(l)	2973	1593	1380	-173	-56	-117	65.0	28.9	36.1																																																	
24. 2,4,6-TRINITROTOLUENE (100+)	C ₇ H ₅ N ₃ O ₆	-14.20(s)	3109	2025	1084	-165	-63	-102	64.8	29.8	35.0																																																	
25. 2,4-DINITROPHENOL (K)	C ₆ H ₄ N ₂ O ₅	-55.50(s)	3065	1477	1588	-165	-42	-123	63.7	21.4	42.3																																																	
26. ACETYLENE	C ₂ H ₂	+54.19(g)	3341	2898	443	-449	-185	-264	190.6	39.6	151.0																																																	
27. NITROETHANE	C ₂ H ₅ NO ₂	-34.33(l)	3007	1064	1943	-213	-57	-176	81.4	22.4	59.0																																																	
28. HYDROGEN CYANIDE	HCN	+31.20(g)	3252	2577	675	-254	-111	-143	107.0	32.1	74.9																																																	
29. ALLENE	C ₃ H ₄	+45.92(g)	3249	1861	1388	-466	-115	-351	190.6	31.2	159.4																																																	
30. METHYLACETYLENE	C ₃ H ₄	+44.32(g)	3246	1815	1431	-466	-111	-355	190.2	30.5	159.7																																																	
31. 1,3-DICHLOROPROPENE	C ₃ H ₄ Cl ₂	-12.00(l)	3021	1228	1793	-166	-79	-137	69.0	11.1	57.9																																																	
32. 1,3-BUTADIENE	C ₄ H ₆	+20.40(g)	3184	991	2193	-469	-46	-423	186.5	16.8	169.7																																																	
33. STYRENE	C ₈ H ₈	+24.83(l)	3191	923	2268	-473	-34	-389	168.2	10.2	158.0																																																	
34. 4-NITROANILINE	C ₆ H ₆ N ₂ O ₂	-9.92(s)	3116	1103	2013	-249	-35	-214	97.8	15.6	82.2																																																	
35. CYCLOPROPANE	C ₃ H ₆	+12.74(g)	3165	936	2229	-508	-47	-461	201.7	19.5	182.2																																																	
36. BIPHENYL	C ₁₂ H ₁₀	+28.50(l)	3194	888	2306	-406	-29	-377	161.6	7.9	153.7																																																	
37. BENZENE	C ₆ H ₆	+11.72(l)	3183	869	2315	-421	-29	-392	167.4	8.8	158.6																																																	
38. BUTENE-1	C ₄ H ₆	-0.03(g)	3143	825	2318	-502	-35	-467	196.4	14.4	182.0																																																	
39. ANILINE	C ₆ H ₇ N	+7.45(l)	3150	822	2328	-380	-25	-355	150.1	9.1	141.0																																																	
40. 1,3-DICHLOROPROPANE	C ₃ H ₆ Cl ₂	-48.30(l)	2961	642	2319	-186	-10	-176	74.5	6.0	68.5																																																	
41. ACETONE	C ₃ H ₆ O	-59.30(l)	3035	704	2331	-348	-19	-329	131.2	9.1	122.1																																																	
42. PROPANE	C ₃ H ₈	-24.82(g)	3095	626	2469	-544	-19	-525	210.2	10.2	200.0																																																	
43. OCTANE	C ₈ H ₁₈	-59.74(l)	3102	591	2511	-514	-15	-499	199.0	8.1	190.9																																																	
44. CELLULOSE (WOOD)	C ₁₂ H ₂₂ O ₁₁	-529.40(s)	2865	758	2107	-204	-19	-185	73.2	9.3	63.9																																																	
45. ACETIC ACID	C ₂ H ₄ O ₂	-115.70(l)	2771	302	2469	-200	-1	-199	69.6	3.3	66.5																																																	
46. PHENYLACETYLENE	C ₈ H ₆	+67.72(l)	3243	1468	1775	-406	-67	-339	164.8	14.4	150.4																																																	
47. 1-(P-NITROPHENYL) ETHANOL	C ₈ H ₉ NO ₃	-53.00(l)	3104	1006	2098	-272	-32	-240	97.8	15.6	82.2																																																	
48. HYDROQUINONE	C ₆ H ₆ O ₂	-87.51(l)	3067	803	2264	-286	-21	-265	107.1	7.5	99.6																																																	
49. BENZAMIDE	C ₇ H ₇ NO	-48.47(s)	3098	748	2350	-320	-18	-302	125.9	6.7	117.2																																																	
50. ACETANIDE	C ₈ H ₉ NO	-75.90(l)	2885	301	2584	-266	-8	-274	98.4	3.4	95.0																																																	

[National Fire Protection Association Classification indicated by number in a diamond, thus ◊. Unclassified by circle, thus ○.]

[The parenthetic number is the cm. required to activate in the U. S. Bur. Mines Jkg. drop weight test. Those underlined are converted Picatinny Arsenal values.] [K is a known explosive.]

*T₀ = flame temp; T_d = decomposition temp

**ΔH₀ = heat of combustion; ΔH_d = heat of explosion

***P₀ = combustion pressure; P_d = explosive pressure; both at const vol

The foregoing dealt with the prediction of *potential* hazards arising from exothermic chemical reactions. To predict the *real* hazard of a reaction one must also consider how fast the reaction takes place. Thus it is necessary to link thermodynamics with chemical kinetics because a potentially dangerous reaction may be so slow under a given set of conditions that it constitutes no real danger. The classic example of this situation is the $2\text{H}_2 + \text{O}_2 = 2\text{H}_2\text{O}$ reaction which is highly exothermic, and consequently potentially dangerous, but exceedingly slow at ambient conditions in the absence of external stimuli (sparks, flame, etc)

Dr. Stull presents the problem very well and we quote (Ref 2):

"In the processing and handling of a chemical or a combination of chemicals, there are two main questions to be answered. First, will there be a reaction? Equilibrium chemical thermodynamics can provide an unequivocal answer to this question if the thermodynamic data for the system is at hand. The previous paper (Ref 1) dealt with this aspect of the problem and was able to identify those systems where energy releases were possible, and related the degree of "potential hazard" to the magnitude of the energy release. However, we do not live in a static, equilibrium world of potential hazards. It is necessary to couple the potential hazard evaluation with the rate of energy release by the reaction, to evaluate the real extent of hazard. The chemical transformation and its associated energy release will range from well behaved to violent depending upon the rate of the reaction

The second main question that must be considered is: what is the time rate of energy release? Once activated, potentially hazardous materials undergo a nonequilibrium chemical reaction forming the most stable products under the prevailing circumstances. The potentially hazardous systems are those capable of generating heat. They may require different levels of activation, but the smaller the energy of activation, the more readily activated. Some materials (those capable of polymerization for example) may be thermally activated by the ambient temperature of the system. Catalysis also plays a vital role in promoting low level activations. Regardless of the mode of activation, if the

heat generated by the reaction can be continuously transferred to the surroundings without creating an increase in temperature, the reaction will proceed quietly in a well behaved manner

If the heat from the reaction is not all continuously transferred to the surroundings, the temperature of the reaction will increase, slowly at first, but will finally reach a temperature where the reaction is catastrophic. Such thermal run-away reactions are referred to as "thermal explosions". These thermal explosion reaction types convert "potential" hazardous systems into "real" hazardous systems. Thus, it is necessary to answer both of these two main questions to evaluate the real hazard of a system"

The actual linking of chemical (Arrhenius) kinetics and thermodynamics was done as follows (Ref 2):

"A square with T_d increasing upward from 0 to 3000°K was plotted on the left side, while E_a was plotted on the right side with values from 0 to 100 kcal/mole increasing in the *opposite* direction (downward). The diagonal line connecting the zeros of the two scales was named the Reaction Hazard Index, or RHI for short. The end of the RHI line at 0°K would unquestionably be at minimum hazard (or zero index), while the end of the RHI line at 0 kcal/mole (zero activation energy) must surely

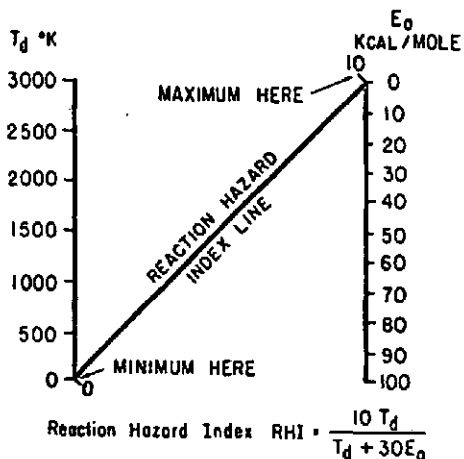

Fig 2 Nomograph Linking the Decomposition Temperature T_d °K with the Arrhenius Activation Energy E_a in kcal/mole (Ref 2)

correspond to maximum hazard (assigned an index value of 10). Thus, RHI values from 0 to 10 cover the whole range from minimum to maximum hazard. The intercept on the RHI line is given by the simple relationship $RHI = 10 T_d/T_d + 30 E_a$. A single value of the Reaction Hazard Index between 0 and 10 provides a numerical index for a given material

Figure 3 shows an example of use comparing the reaction hazard of three hydrocarbon gases, methane, ethylene and acetylene, with the values of T_d , E_a , and RHI given in Table 2. The RHI figures correctly place methane as least reactive, acetylene as most reactive, and ethylene roughly midway between the two"

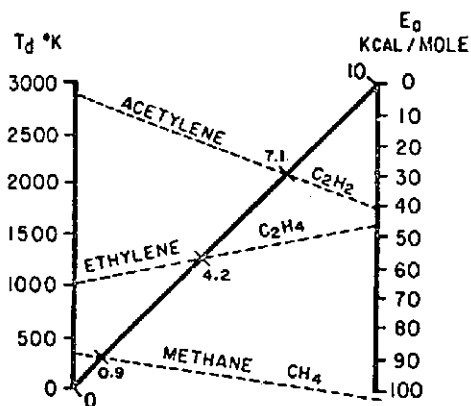

Fig 3 Example of Use of Reaction Hazard Index with Methane, Ethylene, and Acetylene (Ref 2)

TABLE 2
Comparison of NFPA Reactivity Rating with the Reaction Hazard Index (Ref 2)

		T_d °K	E_a kcal/mole	RHI	NFPA Reactivity Rating
CH_4	Methane	298	103	0.9	0
C_2H_4	Ethylene	1005	46.5	4.2	2
C_2H_2	Acetylene	2898	40.5	7.1	4

Again we quote Dr Stull:

"An extended effort was made to find data for as many chemical compounds as possible where the NFPA Reactivity Rating could be compared directly with the Reaction Hazard Index. Table 3 lists 80 compounds where the direct comparison could be made, and includes all of the basic data necessary to calculate the Reaction Hazard Index. The 80 compounds are grouped into the five NFPA Reactivity Ratings as follows: 38 compounds with 0 rating (the largest and best established group), 13 compounds in rating 1 and in rating 2, 6 compounds in rating 3, and 10 compounds in rating 4. A cross plot of the NFPA Reactivity Rating versus the Reaction Hazard Index is presented in Figure 4. The average RHI for each NFPA rating is given in Table 3, and is plotted as a + in Figure 4. The best dotted straight line through the average indices shows a remarkable accord between these two methods of reactivity hazard rating

The NFPA Reactivity Ratings represent the consensus of a committee of experts, and because of the number of factors taken into consideration the values agreed upon might in some instances border on the next higher (or lower) value, and thus be indeterminate by one unit. Hence, acetylene (No 72) rightfully carries the maximum hazardous NFPA Reactivity Rating of 4, and based on the evidence in Table 3, it is not unreasonable that vinylacetylene (No 68) should also

The Reaction Hazard Index method presented here is based on experimentally observed quantities representing the Arrhenius energy of activation for the decomposition process and the energy generated by the decomposition as indicated by the adiabatic decomposition temperature reached by the decomposition products. The method used develops a single numerical value that is characteristic of the reaction hazard for the compound measured and represents the real hazard. Minimum definite measurements can be prescribed for compounds where handling experience is lacking. This objective method can be used to evaluate the real degree of hazard for a single compound or for a mixture of chemicals, and can be used to develop a Reaction Hazard Index system that will effectively rate all chemical reaction hazards with respect to each other"

Table 3
Data Sources, Reaction Hazard Index, and National Fire Protection Association Reactivity Rating

No.	Formula	Gaseous Compound	ΔH_f^{298}	T_d °K	Activation Energy for Decomposition		Reaction Hazard Index RHI	NFPA Reactivity Rating
			kcal/mole Ref. (24)		kcal/mole	Ref.**		
1	CHCl ₃	Chloroform	- 24.2	683	47.0	(1)	3.26	0
2	CH ₂ O ₂	Formic Acid	- 90.49	800	30.6	(1)	4.66	0
3	CH ₃ Cl	Methyl Chloride	- 20.63	744	74.0	(4)	2.55	0
4	CH ₄	Methane	- 17.89	298	103.0	(1)	0.88	0
5	CH ₅ N	Methylamine	- 5.50	767	58.0	(21)	3.06	0
6	C ₂ H ₄ Cl ₂	1, 1-Dichloroethane	- 31.05	847	53.5	(10)	3.45	0
7	C ₂ H ₄ Cl ₂	1, 2-Dichloroethane	- 31.00	849	47.0	(21)	3.76	0
8	C ₂ H ₅ Br	Ethylbromide	- 15.30	670	53.2	(21)	2.96	0
9	C ₂ H ₅ Cl	Ethylchloride	- 26.70	701	56.5	(1)	2.93	0
10	C ₂ H ₆	Ethane	- 20.24	597	89.5	(1)	1.82	0
11	C ₂ H ₇ N	Dimethylamine	- 4.50	792	43.4	(21)	3.78	0
12	C ₂ H ₇ N	Ethylamine	- 11.00	740	43.4	(21)	3.62	0
13	C ₃ H ₆	Cyclopropane	+ 12.74	936	65.5	(1)	3.22	0
14	C ₃ H ₆ O	Acetone	- 51.99	774	68.	(21)	2.75	0
15	C ₃ H ₇ Cl	1-Chloropropane	- 31.10	699	55.0	(21)	2.98	0
16	C ₃ H ₈	Propane	- 24.82	626	63.3	(21)	2.48	0
17	C ₄ H ₈	1-Butene	- 0.03	825	59.1	(1)	3.18	0
18	C ₄ H ₈	Cyclobutane	+ 6.37	865	62.5	(7)	3.16	0
19	C ₄ H ₈ O	2-Butanone	- 56.97	755	67.2	(21)	2.72	0
20	C ₄ H ₈ O ₂	Ethylacetate	- 105.86	735	48.0	(1)	3.38	0
21	C ₄ H ₉ Br	1-Bromobutane	- 25.65	668	50.9	(21)	3.04	0
22	C ₄ H ₉ Cl	1-Chlorobutane	- 35.20	701	57.0	(21)	2.91	0
23	C ₄ H ₁₀	Butane	- 30.15	633	86.3	(1)	1.96	0
24	C ₄ H ₁₀	2-Methylpropane	- 32.15	611	53.5	(21)	2.76	0
25	C ₄ H ₁₀ O	tert-Butyl Alcohol	- 77.87	628	61.6	(1)	2.54	0
26	C ₄ H ₁₀ O	Ethyl Ether	- 61.88	761	78.0	(1)	2.46	0
27	C ₅ H ₁₀ O ₂	Iso-propylacetate	- 115.40	696	45.0	(1)	3.40	0
28	C ₅ H ₁₂	2, 2-Dimethylpropane	- 39.67	597	80.4	(1)	1.98	0
29	C ₅ H ₁₂	2-Methylbutane	- 36.92	626	58.6	(21)	2.62	0
30	C ₅ H ₁₂	Pentane	- 35.00	645	61.2	(21)	2.60	0
31	C ₅ H ₁₂ O	2, 2-Dimethylpropanol	- 70.00	725	60.0	(1)	2.87	0
32	C ₆ H ₁₂	Cyclohexane	- 29.43	677	64.1	(19)	2.60	0
33	C ₆ H ₁₂ O ₂	Butylacetate	- 116.7	715	46.0	(1)	3.41	0
34	C ₇ H ₈	Toluene	+ 11.95	859	85.0	(1)	2.52	0
35	C ₇ H ₁₄	Methylcyclohexane	- 36.99	660	57.9	(19)	2.75	0
36	C ₇ H ₁₄ O ₂	tert-Amylacetate	- 122.7	705	40.3	(1)	3.68	0
37	C ₈ H ₁₀	Ethylbenzene	+ 7.12	830	73.0	(1)	2.75	0
38	C ₈ H ₁₀	4-Xylene	+ 4.29	817	79.5	(1)	2.55	0
Average of 38 compounds							2.89	0
39	CH ₆ N ₂	Methylhydrazine	+ 20.40	1022	51.9	(1)	3.96	0
40	C ₂ H ₄ O ₂	Acetic Acid	- 104.93	634	67.5	(1)	2.38	0
41	C ₂ H ₈ N ₂	1, 1-Dimethylhydrazine	+ 20.30	953	49.6	(1)	3.90	0
42	C ₃ H ₅ Br	Allylbromide	+ 11.80	988	45.5	(21)	4.20	0

Table 3 (Continued)

No.	Formula	Gaseous Compound	$\Delta H_f^{\circ} 298$		Activation Energy for Decomposition		Reaction Hazard Index RHI	NFPA Reactivity Rating
			kcal/mole Ref. (24)	$T_d^{\circ} K$	kcal/mole	Ref. **		
43	C ₃ H ₅ N	Propionitrile	+ 12.10	903	72.7	(1)	2.93	1
44	C ₃ H ₆	Propylene	+ 4.88	866	78.0	(1)	2.70	1
45	C ₃ H ₆ O	Propionaldehyde	- 45.90	819	50.3	(21)	3.52	1
46	C ₄ H ₆ O ₃	Acetic Anhydride	- 137.60	793	34.5	(1)	4.34	1
47	C ₅ H ₁₀ O ₃	Diethyl Carbonate	- 151.60	753	46.0	(1)	3.53	1
48	C ₆ H ₁₄ O	Iso-propyl Ether	- 76.20	712	63.5	(1)	2.72	1
49	C ₇ H ₇ Cl	Benzyl Chloride	- 7.30	831	68.0	(1)	2.89	1
50	C ₁₀ H ₁₂	Dicyclopentadiene-endo	+ 46.60	990	34.0	(1)	4.93	1
51	C ₁₀ H ₁₂	Dicyclopentadiene-exo	+ 46.60	990	38.5	(1)	4.61	1
Average of 13 compounds							3.58	1
52	C ₂ H ₄	Ethylene	+ 12.50	1005	46.5	(1)	4.19	2
53	C ₂ H ₄	Ethylene	+ 12.50	1005	37.7*	(21)	4.71	2
54	C ₂ H ₄ O	Acetaldehyde	- 39.76	866	48.0	(21)	3.76	2
55	C ₃ H ₆ O	Propylene Oxide	- 22.17	948	58.0	(26)	3.53	2
56	C ₃ H ₆ O ₂	Dioxolane	- 70.0	911	53.	(9)	3.64	2
57	C ₄ H ₆	1, 3-Butadiene	+ 20.40	991	79.4	(22)	2.94	2
58	C ₄ H ₆	1, 3-Butadiene	+ 20.40	991	24.7	(27)	5.72	2
59	C ₄ H ₈ O	Crotyl Alcohol	- 37.40	863	41.0	(1)	4.12	2
60	C ₄ H ₈ O	Vinyl Ethyl Ether	- 33.50	880	44.4	(1)	3.98	2
61	C ₅ H ₈ O	Vinyl Allyl Ether	- 12.8	959	30.6	(1)	5.11	2
62	C ₈ H ₈	Styrene	+ 35.22	993	19.2*	(2)	6.33	2
*For the polymerization process								
63	C ₈ H ₁₂	Vinyl Cyclohexane	+ 16.8	876	62.2	(1)	3.18	2
64	N ₂ H ₄	Hydrazine	+ 22.75	1338	60.5	(20)	4.24	2
Average of 13 compounds							4.27	2
65	C ₂ H ₄ O	Ethylene Oxide	- 12.58	1062	57.4	(1)	3.81	3
66	C ₂ H ₅ NO ₂	Nitroethane	- 24.20	1161	45.0	(1)	4.62	3
67	C ₃ H ₇ NO ₂	1-Nitropropane	- 29.80	1046	47.7	(1)	4.22	3
68	C ₄ H ₄	Vinylacetylene	+ 72.80	2317	28.	(3)	7.33	3
69	C ₈ H ₁₈ O ₂	tert-Butyl Peroxide	- 81.50	850	37.4	(1)	4.31	3
70	C ₁₂ H ₁₆ N ₄ O ₁₈	Cellulose Nitrate	- 229.80	2213	46.7	(14)	6.12	3
Average of 6 compounds							5.07	3
71	CH ₃ NO ₂	Nitromethane	- 17.86	2621	59.0	(1)	5.97	4
72	C ₂ H ₂	Acetylene	+ 54.19	2898	40.5*	(21)	7.05	4
73	C ₂ H ₄ O ₃	Peracetic Acid	- 97.73	976	32.0	(1)	5.04	4
74	C ₂ H ₅ NO ₃	Ethyl Nitrate	- 36.8	2094	39.9	(21)	6.36	4
75	C ₃ H ₅ N ₃ O ₉	Nitroglycerine	- 73.20	2895	40.3	(1)	7.05	4
76	C ₄ H ₆ O ₄	Acetyl Peroxide	- 116.1	983	29.5	(1)	5.26	4
77	C ₄ H ₁₀ O ₂	tert-Butyl Hydroperoxide	- 62.9	919	37.8	(1)	4.48	4
78	C ₄ H ₁₀ O ₂	Diethyl Peroxide	- 46.1	968	37.3	(1)	4.64	4
79	C ₈ H ₁₈ O ₂	Di-tert-butyl Peroxide	- 81.5	850	37.5	(25)	4.30	4
80	C ₉ H ₁₂ O ₂	Cumene Hydroperoxide	- 21.9	989	29.0	(25)	5.32	4
Average of 10 compounds							5.55	4

*For the polymerization process.

**See Ref 2.

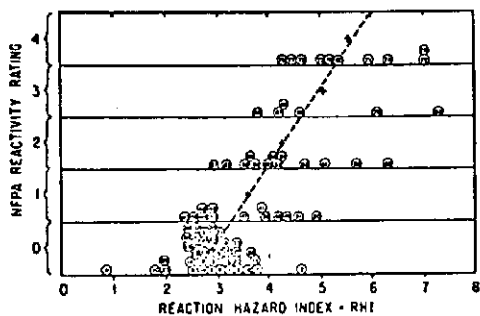

Fig 4 Correlation of the NFPA Reactivity Rating with the Reaction Hazard Index (Ref 2)

- Refs: 1) D.R. Stull, Chem Eng Prog, Loss Prevention, 4, 16 (1970)
2) D.R. Stull, Ibid, 7, 67 (1973)

Hazards—Prevention of Industrial Gas Explosions.

In the prevention of industrial gas explosion disasters, the most useful terms for evaluating the hazards of various fuel/oxidant systems are believed to be limits of flammability and min spontaneous ignition temp (Ref 3)

The addition of a flammable diluent is suggested as a method of preventing explosions in processes involving flammable gas mixts; e.g., the addition of sufficient methane to a potentially explosive mixt of H + O in a hydrogen peroxide plant suppresses explosive reactions without excessive loss of plant throughput capacity which would have resulted if an inert suppressant (diluent) such as nitrogen were added to the mixture. Butane or pentane are even more effective than methane (Ref 1)

Spraying with 10-20 psi steam is suggested before introducing an air stream (carrying wood preservatives) into an organic vapor atm (Ref 2)

- Refs: 1) E. Jones, Chem Eng 59 (6), 185 (1952) & CA 46, 8374 (1952) 2) M. Hudson, USP 2633429 (1953) & CA 48, 5502 (1954) 3) M.G. Zabetakis and G.W. Jones, Chem Eng Prog 51, 411 (1955) & CA 49, 15241 (1955)

HBX (High Blast Explosive). High explosive compositions containing RDX, TNT, Al and a wax desensitizer. **HBX-1** consists of RDX 40, TNT 38, Al 17, D-2 wax 5% & 0.5% added CaCl₂. It was developed during WWII as a desensitized modification of *Torpex* (Ref 1). A further modification, **HBX-3**, consists of RDX 31, TNT 29, Al 35, D-2 wax 5% & .5% added CaCl₂. HBX-1 and HBX-3 are prepared by adding water-wet RDX to molten TNT and heating until the water is evaporated. The D-2 wax (84% paraffin, 14% NC, 2% lecithin) and CaCl₂ are then added. Both HBX-1 and HBX-3 are powerful and brisant explosives whose physical and explosive properties are tabulated here after description of prepn

HBX expl compns are prepd by melting TNT in a steam jacketed kettle equipped with a mechanical stirrer. Water-wet RDX is added slowly with stirring and heating until all the water is evapd. Powdered Al is added and the mixture is continued to be stirred until uniform. D-2 wax and Ca chloride are then added and the mixture is cooled from temp 95–100° to a temp considered suitable for casting (the lowest practicable pour temp)

HBX can also be prepd by adding the calcd amt of molten TNT to molten Comp B to obtain the desired proportion of RDX/TNT and then the appropriate weights of other ingredients are added to complete the compn (Ref 6, p 163)

NOTE: The desensitizer wax, also known as Composition D-2, consists of 84% paraffin wax, 14% NC and 2% lecithin. Its Military Specification Requirements and Tests are in MIL-C-1864

TABLE
Properties of HBX's

Properties	HBX-1	HBX-3
Mol Wts	102	64
OB to CO ₂ , %	-68	-75
OB to CO, %	-35	-49
Ballistic Mortar:	133% TNT	111% TNT
% TNT in Air	121 (Shock)	116 (Shock)
% TNT in Air	121 (Impulse)	125 (Impulse)
Blast Effects:		
% TNT under water	111 (Shock)	101 (Shock)
% TNT under water	145 (Bubble)	191 (Bubble)
Brisance by Sand Test, % TNT	102 (123)	93.5
Density, g/cc	1.69-1.70	1.81-1.84
Detonation Rate, m/sec	7224	6927
Expln Temp (5 sec)	480°	500°
Fragmentation Test in 90mm, HE, M71 Shell		
No of Fragments vs TNT	910	476
Friction Sensitivity		703
Gas Volume		Unaffected
Heat of Combstn, cal/g	3882	Not given
Heat of Expln, cal/g	919	4495
Heat of Formation, cal/g	758	877
Heat Test at 100°		491
% Loss in 1st 48 hrs	0.058	0.70
% Loss in 2nd 48 hrs	0	0
Expln in 100 hrs	None	None
Hygroscopicity, % Loss (in 7 days at 30° and 95% RH)	2.98	2.01
Impact Sensitivity		comparable to TNT
Rifle Bullet Test		more sensitive than TNT
Sensitivity to Initiation		Require slightly lower minimum priming chge
Storage	Dry	Dry
Usage		Principally in HE charges, such as in GP bombs

Note: HBX-1 was recommended for use in booster charges and in depth charges (Refs 4, 5 & 6)

Refs: 1) Anon, "Powerful Explosives Developed", Army Ordn 30, 102 (1949) 2) S.R. Walter, "Report on the Program to Develop an Improved HBX-Type Explosive", NAVORD Rept 1502 (1950) 3) NAVORD Rept 2986 (1953), Explosive Data Sheet, Sectn D-2 4) O.E. Sheffield, "Blast Properties of Explosives Containing Aluminum or Other Metal Ingredients", PATR 2353 (1956) 5) S.D. Stein, G.J. Horvat & O.E. Sheffield,

"Some Properties and Characteristics of HBX-1, HBX-3 and H-6", PATR 2431 (1957) 5a) N.O. Holland, Editor, "Explosives - Effects and Properties", NOLTR 65-218 (Feb 1967), Sect D-4 6) Anon, Engineering Design Handbook, "Properties of Explosives of Military Interest", Army Materiel Command Pamphlet, AMCP 706-77 (Jan 1971), pp 156-163

HBX-1, HBX-3 and H-6 Explosive Compositions
US Military Specification Requirements and Tests,
as described in MIL-E-22267A (31 May 1963)

Requirements:

3.2 Form. Unless otherwise specified the compns
HBX-1, HBX-2 & H-6 shall be supplied in the form
of buds or as strips 1.5 inches wide, 1 inch deep &
3 inches long

3.4 Components. The components used in the
preparation of the Grade A HBX and H-6 compo-

sition shall comply with the specifications listed
in 2.1 and shall be of the following grade or class
as applicable

Composition B	Grade A
TNT	Grade I
Al Powder	Type III, Grade F, Class 7

3.5 Grade A Compositions. The composition of
the Grade A HBX composition shall conform to
the nearest tenth percent as required in Table I
when tested as specified in 4.4.3.2 or 4.4.3.3

Table I. Grade A Compositions

Ingredient	HBX-1 Percent by Weight	HBX-3 Percent by Weight	H-6 Percent by Weight
*RDX plus Nitrocellulose plus **Calcium Chloride plus ***Calcium Silicate	40.4 ± 3.0%	31.3 ± 3.0%	45.1 ± 3.0%
TNT	37.8 ± 3.0%	29.0 ± 3.0%	29.2 ± 3.0%
Aluminum	17.1 ± 3.0%	34.8 ± 3.0%	21.0 ± 3.0%
**** Wax plus lecithin	4.7 ± 1.0%	4.9 ± 1.0%	4.7 ± 1.0%

* Note. All of the RDX component and portions of the TNT and wax are added as Composition B.

** A separate calcium chloride determination need only be done if required in the contract or order (See 6.2).
Percentage requirement of Calcium Chloride is 0.5% ± 0.1%

*** Calcium Silicate shall be determined as specified in 4.4.1.2 when used in the formulation of HBX com-
pounds. The Calcium Silicate content shall be a minimum of 1.25 weight percent of the TNT content of the
mixture and shall only be used in the HBX compositions when specified by the procuring agency (See 6.2).
Calcium Silicate is designated for use only in Army formulations of HBX type explosive compositions.

**** The major portion of the wax and all of the Nitrocellulose and lecithin are added as Composition D-2

3.6 Grade B Compositions. The composition of
the Grade B HBX & H-6 Composition shall con-
form to the nearest tenth percent as required in
Table II when determined as specified in 4.4.3.4

Table II. Grade B Compositions

Ingredient	HBX-1 Percent by Weight	HBX-3 Percent by Weight	H-6 Percent by Weight
RDX plus Nitrocellulose plus Calcium Chloride plus *Calcium Silicate	40.4 ± 3.0%	31.3 ± 3.0%	45.1 ± 3.0%
TNT	37.8 ± 3.0%	29.0 ± 3.0%	29.2 ± 3.0%
Aluminum	17.1 ± 3.0%	34.8 ± 3.0%	21.0 ± 3.0%
Wax plus lecithin	4.7 ± 1.0%	4.9 ± 1.0%	4.7 ± 1.0%

Hot melt (asphaltic lining material) – maximum allowable 0.75%

A separate Calcium Chloride detn need only be done if required in the contract or order. An additional
one-half percent of Calcium Chloride shall be added whenever preparing the reclaimed explosive for re-use.
Percentage requirement is 0.7% ± 0.3%

* The Calcium Silicate content shall be a minimum of 1.25 weight percent of the TNT content of the
mixture and shall only be used in the HBX compositions when specified by the procuring agency (See 6.2).
Calcium Silicate shall be determined as specified in 4.4.1.2

3.7 *Moisture Content*, when tested as specified in 4.4.4 shall be 0.20% max for Grade A and 0.50% for Grade B

3.8 *Vacuum Stability*. The max volume of gas liberated when tested as specified in 4.4.5 shall be 2cc/g/48 hrs at 100° for Grade A and B

4.2 *Lot Size*. For the purpose of sampling a lot shall be limited to 1300 lbs max and to one batch from a single vessel. Tests shall be conducted on each lot

4.3.1 *Preproduction Samples*. After award of contract but prior to entering quantity production, a preproduction sample shall be prep'd for inspection and acceptance tests to determine conformance of the sample with the requirements of the specification (See 6.2)

4.3.1.1 *Preproduction Sample for Subsequent Contracts*. The necessity for such a sample will be det'd by the procuring activity when production under a new contract by the same contractor at the same location follows the prep'n of any HBX or H-6 compns covered by this spec

4.3.2.1 *Sample for Chemical Composition Analysis* is taken by catching a portion of the molten expl compn, from the approx center of the batch, and pouring into shallow Al dish 4 inches in diam in order to obtn on cooling a wafer approx ¼ inch thick

4.3.2.2 *Sample for Moisture Analysis* consists of approx 50g reserved from 4.3.2.1

4.4.1 *Process Verification*. Unless otherwise specified, process verification used as the inspection shall be subject to Government verification at the time the first batch is prepared and at random intervals during the production, but not less than once during each week of continuous operation. Verification will consist of surveillance of the process and related equipment to determine that practices, methods and procedures are being properly applied, and that the products are produced under the requirements of this specification. A record shall be made of each batch of explosive prepared to insure that the following requirements have been met:

(a) Explosive components – Components shall meet the requirements of 3.4

(b) Composition – The quantities of each component required shall be calculated and weighed to give the correct composition. Component weights may be calculated from Table III

(c) Order of addition – The order of addition shall be recorded. Order of addition shall be mandatory as specified in 3.3

(d) Temperature – The temperature shall be recorded, prior to, during, and after each phase of batching

(e) Agitation – Agitation shall be maintained from the time of the addition of the first component until the kettle has been drained

(f) Mixing time – The mixing time following the addition of the last component

Table III. HBX Compositions
(Percent by Weight)

	HBX-1	HBX-3	H-6
Composition B	66.08	51.33	74.20
Composition D-2	4.66	4.73	4.69
Aluminum	17.10	34.75	20.61
Additional TNT	11.66	8.69	—
Calcium Chloride	0.50	0.50	0.50
Calcium Silicate	0.47 ^a	0.36 ^a	0.37 ^a

Each component shall be based on the percent by weight limitation listed in Table I or II for each HBX formulation

a) When specified by the procuring activity, Calcium Silicate used in the formulation of HBX components shall be a minimum of 1.25 weight percent of the TNT content

4.4.1.2 *Determination of Calcium Silicate*. When specified by the procuring activity (See 6.2), Calcium Silicate used in the HBX & H-6 compositions shall be determined by visual verification of the weight of calcium silicate added to the batch. Quantities added shall be calculated in terms of weight percent of TNT content

4.4.2 *Lot Acceptance Tests*. Unless otherwise specified in the contract or order, samples selected from each inspection lot shall be subjected to all the requirements and tests of this specification. Failure of the HBX compositions to meet any of the requirements or tests of this specification shall be considered cause for rejection of the lot

4.4.3 *Composition Analysis*

4.4.3.1 *Sample Preparation*. Reduce sample thru a 20 mesh screen (US Standard Sieve Series) using a wooden mortar and pestle

4.4.3.2 *Method of Analysis. Grade A:*

4.4.3.2.1 *Determination of Aluminum*. Weigh accurately a sample calculated to contain 0.4g of TNT into a tared sintered glass filtering crucible, medium porosity, 30-ml capacity. Extract on a Fisher filtrator with ethylene chloride (purified 1,2 dichloroethane) at approx 20°C. 5 equal portions totaling 45ml, contact time of 1 min each.

Collect filtrate in a 50ml volumetric flask. Reserve filtrate for TNT determination

The residue remaining on the filtering crucible is extracted with hot cyclohexanone (highest purity grade) at approx 100°C. Five consecutive 3-second extractions of 3ml each with continuous vacuum filtration and no stirring are made. This is followed by four consecutive 30-sec extractions of 10ml each with stirring. After the cyclohexanone extraction, wash down the sides of the crucible with approx 2ml of reagent grade acetone. Repeat for a total of 3 washings. Dry in an oven at 90°C ±10°C for 30 mins, cool in a desiccator and weigh. The residue is aluminum

$$\text{Percent Al} = [(A-B) \times 100] / W$$

where: A = Wt of crucible with Al

B = Wt of empty crucible

W = Wt of sample

4.4.3.2.2 TNT Determination. Dilute the TNT filtrate obtd in 4.4.3.2.1 to 50ml with ethylene chloride. Compare its spectral absorbance at 20° with that of a soln, 0.400g of TNT in 50ml ethylene chloride at 367 millimicrons. Det TNT by reference to a graph prepd in advance from known soln. The prepn of the solns and the graph is described in 4.4.3.5.1. A Beckman DK-2 or equivalent spectrophotometer may be used to det the spectral absorbance

When using the Beckman DK-2 recording spectrophotometer, one proceeds under the following conditions:

- a) 10mm cell with 9mm spacer
- b) Wavelength setting of 367 millimicrons
- c) Time constant of 0.6
- d) Scanning time of 1
- e) Scale expansion -2X
- f) Sensitivity -11.5
- g) Adsorption scale of -0.3 +0.7
- h) Hydrogen lamp
- i) Photomultiplier position -1X

$$\text{Percent TNT} = (A \times 100) / W$$

where: A = Wt of TNT from graph

W = Wt of sample

4.4.3.2.3 Determination of Wax + Lecithin. Weigh a 3-g sample and transfer it to a small, accurately tared, test tube. Add exactly 3ml of tetrachloroethylene and reweigh the tube with contents. Heat it in a steam bath to 90° while stirring vigorously and transfer to a water bath used to maintain the prisms of an Abbe refractometer at 50+0.5°. After

cooling, reweigh the tube with contents to det exact amt of tetrachloroethylene lost by volatilization. Replace the exact amt of loss and insert the tube in the water bath. Set the refractometer to read 1.4910 as the RI of tetrachloroethylene at 50+0.5° and pour several drops of the supernatant liquid from the test tube unto the prisms of the refractometer. Quickly close the prisms and at the end of 30 secs det the RI to sodium D light. The wax + lecithin concn is detd by reference to a graph previously prepd from known solns. The preps of the solns and the graph are described in 4.4.3.5.2

$$\text{Percent Wax + Lecithin} = (C \times 100) / W$$

where: C = Wt of wax + lecithin from the graph

W = Wt of sample

4.4.3.2.4 Determination of Calcium Chloride.

Weigh accurately a 2-g sample into a tared sintered glass filtering crucible, medium porosity, 30-ml capacity. Using a Fisher filtrator with water vacuum, extract sample with 100ml of distd w, 10 extractions, 10ml each, of 30 sec duration. Collect filtrate in a 250 Erlenmeyer flask. Cool to RT and add 2ml of 0.1M K chromate indicator to the filtrate. (For the prepn of 0.1M K chromate see 4.4.3.5.3). Titrate to the end point with 0.1N Ag nitrate. (For the prepn of 0.1N Ag nitrate soln, see 4.4.3.5.4). The end point is noted by the first of a permanent colored red ppt of Ag chromate. The end point should be detd by using a white background or by transferring filtrate plus a minimum of distd w washings to a white casserole

$$\text{Percent Ca Chloride} = [V \times N \times (0.0555)] / W$$

where: V = ml of Ag nitrate

N = Normality of Ag nitrate

0.0555 = Millequivalent weight of Ca chloride

W = Weight sample

4.4.3.2.5 Determination of RDX + Nitrocellulose.

The percentages of TNT, Ca chloride, aluminum, and wax + lecithin are added and their sum subtracted from 100 percent. The remainder is taken to be the percentage of RDX plus Nitrocellulose

4.4.3.3 Alternate Method of Analysis. Grade A

4.4.3.3.1 Determination of RDX + Nitrocellulose.

Weigh accurately a sample calculated to contain between 0.35 and 0.40g of TNT into a tared 100-ml beaker. Add 20ml of RDX saturated benzene to the beaker. The prepn of the RDX saturated benzene is described in 4.4.3.5.5. Cover beaker with a watch glass and place on a steam bath for 30 mins, swirl soln frequently. (An oscillating hot

plate may be used if available). Do not boil the benzene! After removal from the steam bath, cool sample to RT. Allow a minimum of 1 hour cooling

Make a quantitative transfer of the sample to the original tared filtering crucible. Filter using a Fisher filtrator with water suction. Use a small polyethylene wash bottle which contains benzene saturated with RDX to make the transfer. Make a total of 3 washings of the beaker and residue on the crucible, using between 10 and 15ml of benzene saturated RDX per rinse. Make a final rinse of the crucible contents with 5ml of benzene saturated with RDX. Collect the filtrate which contains TNT and wax in a 100-ml volumetric flask. Reserve the filtrate to det the TNT content. Aspirate the crucible for 1 min after the final rinse

The crucible plus its contents are placed on a Fisher filtrator, and extracted with hot distd w, 3 portions of 5ml each, 30 secs contact time for each washing. This is necessary to remove any Ca chloride that may be remaining in the residue. Dry crucible and its contents in an oven at $90^{\circ}\text{C} \pm 10^{\circ}\text{C}$ for 1 hour. Cool the sample in a desiccator and weigh. The crucible and its contents are placed on a Fisher filtrator, attached to a water aspirator. Extract the sample with four 20-ml portions of hot, reagent grade, acetone. Allow 30 secs contact time between solvent and sample before applying suction for each extraction. Wash down the sides of the crucible with two additional portions of 10ml each of hot acetone. Place crucible and its residue in an oven to dry at $90^{\circ}\text{C} \pm 10^{\circ}\text{C}$ for 30 mins, cool in a desiccator and weigh. RDX and Nitrocellulose are removed in the filtrate. Aluminum remains as the residue on the crucible

$$\text{Percent RDX + Nitrocellulose} = \frac{[(A-B) \times 100]}{W}$$

where: A = Wt of sample plus crucible before acetone extraction

B = Wt of residue plus crucible after acetone extraction

W = Wt of sample

4.4.3.3.2 Determination of Aluminum. The aluminum is the residue remaining on the crucible after the acetone extraction

$$\text{Percent aluminum} = \frac{[(B-D) \times 100]}{W}$$

where: B = Wt of residue plus crucible after acetone extraction

D = Wt of original crucible

W = Wt of sample

4.4.3.3.3 Determination of TNT. For method of prepn and standardization of solns needed in the TNT detn see 4.4.3.5.6 thru 4.4.3.5.13

Dilute the TNT and wax filtrate obtd in 4.4.3.3.1 to 100ml with benzene satd with RDX. Transfer a 10-ml aliquot of the TNT soln which contns 35–40mg of TNT to a 300-ml reduction flask (Scientific Glass Apparatus Co JD2776 or equivalent is satisfactory). Evaporate the benzene to dryness with a slow stream of dry air (connect a drying tube between wir supply and inlet tube of flask).

Dissolve the residue in 25ml of reagent grade glacial acetic acid (measure in a cylinder). Sweep the flask with N_2 or CO_2 gas for 5 mins. Pipette accurately 25ml of 0.2N titanous chloride soln into the flask. Add 25ml of 6N HCl. A current of CO_2 or N_2 should be passed thru the reaction flask during the refluxing, cooling and titration periods to prevent air oxidation of the titanous ion. Reflux for 15 mins, using glass beads to reduce bumping. (Ground glass joints on the flask and condenser are to be preferred. A Glass-Col heating mantle is the most convenient source of heat, though a hot plate may be used). Cool the flask to RT without disconnecting the reflux condenser. (Lift the flask and condenser and substitute a pan of cold water for the heater). Titrate the sample in the flask with standard ferric ammonium sulfate (0.15N) soln, using a magnetic stirrer if available. As the end point is approached [the Ti(III) color gets light] add 5ml of 20% ammonium thiocyanate and continue the titration to the appearance of the red color

At least 4ml of 0.15N Fe(III) soln should be required in back titration. If less, repeat adding more Ti(III) soln in excess to the TNT–wax filtrate. [If less than 4ml of Fe(III) soln is used in the back titration in either standardization of Ti(III) soln or in the detn of TNT, low values may be obtd. If the excess Ti(III) at the end of the refluxing is too small, reduction of the nitro groups may be incomplete. On the other hand, if more than 10ml of Fe(III) soln is used, an unnecessarily large excess of Ti(III) soln is being added].

Run a blank on a volume of RDX satd benzene equal to the volume of the aliquot of sample soln used in the preceding titration

$$\text{Percent TNT} = \frac{[0.1261 \times (AN-BF) - (CN-DF) \times 100]}{W}$$

where: A = ml of Ti(III) soln
 N = Normality of Ti(III) soln
 B = ml of Fe(III) soln
 F = Normality of Fe(III) soln
 C = ml Ti(III) added to blank
 D = ml Fe(III) added to blank 0.01261g
 TNT = 1 meq of TNT
 W = Wt of sample represented by aliquot
 AN-BF = Meq Ti(III) used by TNT & RDX
 CN-DF = Meq Ti(III) used by RDX

4.4.3.3.4 Determination of Calcium Chloride.

Calcium chloride is determined as in 4.4.3.2.4

4.4.3.3.5 Determination of Wax + Lecithin. The percentages of TNT, RDX plus Nitrocellulose, Ca chloride, and aluminum are added and their sum subtracted from 100 percent. The remainder is taken to be the percentage of wax plus lecithin

4.4.3.4 Method of Analysis. Grade B

4.4.3.4.1 Determination of Hot Melt - Visually. Weigh accurately a 1 g sample of HBX into a tared sintered glass filtering crucible, medium porosity, 30-ml capacity. Using approx 5ml of ethylene chloride, divided into 5 equal portions, 1 min contact time each, extract sample on a Fisher filtrator with water vacuum. Collect filtrate in a 50-ml volumetric flask and dilute to the mark with ethylene chloride. Compare the color of the filtrate visually with previously prepd standards to det the weight of hot melt present. The prepn of the hot melt standard solns are described in 4.4.3.5.14

$$\text{Percentage of hot melt} = (A \times 100) / W$$

where: A = Wt of hot melt from comparison with standards

W = Wt of sample

4.4.3.4.2 Determination of Hot Melt - Spectrophotometer. Compare the spectral absorbance at 20°C of the ethylene chloride filtrate obtd in 4.4.3.2.1 or 4.4.3.4.1 with that of a standard soln (0.4g of TNT/50ml of ethylene chloride) at 430 millimicrons. The weight of hot melt is detd by reference to a graph prepd in advance from standard hot melt solns. The prepn of the solns and graph are described in 4.4.3.5.14. The TNT + wax + hot melt filtrate collected in 4.4.3.3.1, diluted to 50ml with RDX satd benzene may be substituted for the ethylene chloride-TNT soln obtd in 4.4.3.4.1. All graphs and standard solns needed will substitute RDX satd benzene for ethylene chloride

$$\text{Percentage of hot melt} = (A \times 100) / W$$

where: A = Wt of hot melt obtd from the graph
 W = Wt of sample

4.4.3.4.3 Determination of TNT - Spectrophotometer. Hot melt interferes with the method for the absorbance of TNT as described in 4.4.3.2.2. Corrected TNT values can be obtd by comparing the TNT soln at 430 millimicrons in addition to 367 millicrons. At 430 mu, the absorption is due to the hot melt alone. Correct the weight for TNT obtd from TNT spectral absorbance graph by subtracting from it the value obtd from a correction graph prepd in advance as described in 4.4.3.5.15. The TNT + wax + hot melt filtrate collected in 4.4.3.3.1, diluted to 50ml with benzene satd RDX may be substituted for the ethylene chloride soln in 4.4.3.2.2. All graphs and standard solns needed will substitute RDX satd benzene for ethylene chloride

$$\text{Percent TNT} = [(A-B) \times 100] / W$$

where: A = Wt of TNT from TNT spectral calibration graph

B = TNT correction value from the TNT correction graph

W = Wt of the sample

4.4.3.4.4 Determination of TNT - Titanous Chloride Method. Hot melt is present in the TNT wax filtrate obtd in 4.4.3.3.1. This filtrate is used in the TNT detn by the titanous chloride method. Hot melt does not interfere with the TNT detn

4.4.3.4.5 Determination of Aluminum. The method described in 4.4.3.2.1 or 4.4.3.3.2 may be used to detn the aluminum content

4.4.3.4.6 Determination of RDX + Nitrocellulose. The method described in 4.4.3.2.5 or 4.4.3.3.1 may be used to detn the RDX + Nitrocellulose content

4.4.3.4.7 Determination of Calcium Chloride. The method described in 4.4.3.2.4 is used to detn the Ca chloride content

4.4.3.4.8 Determination of Wax + Lecithin. The percentages of TNT, RDX plus Nitrocellulose, Ca chloride, aluminum, and hot melt are added and their sum subtracted from 100%. The remainder is taken to be the percentage of wax plus lecithin

Where the method of analysis described in 4.4.3.3 is not used in its entirety, the wax plus lecithin content can be detd as follows: The crucible plus residue obtd after the RDX satd benzene extraction as described in 4.4.3.3.1 is extracted with an additional 50ml of RDX satd benzene (5-10ml portions, 30 secs each). The sample is dried at 100°C for 30 mins. The crucible

plus residue are cooled in a desiccator and weighed. The loss in weight of the sample is equal to the weight of the TNT + wax + hot melt extracted

$$\text{Percent wax + lecithin} = \frac{[A - (B + C)] \times 100}{W}$$

where: A = Loss in wt of sample after RDX satd benzene extraction

W = Wt of sample

B = Wt of TNT detd in 4.4.3.2.2 or 4.4.3.3.3

C = Wt hot melt detd in 4.4.3.4.1 or 4.4.3.4.2

The refractive index method for the detn of wax plus lecithin described in 4.4.3.2.3 cannot be used when hot melt is present

4.4.3.5 Preparations of Solutions, Graphs and Standardization of Solutions:

4.4.3.5.1 Preparation of TNT Standard Solutions and TNT Spectral Calibration Graph. Prepare a stock TNT soln. Accurately weigh and transfer 8g of TNT into a 500-ml volumetric flask. Dilute to mark with ethylene chloride

Into each of seven 50-ml volumetric flasks, pipette accurately the following quantities of the TNT stock soln respectively, 22ml, 23ml, 24ml, 25ml, 26ml, 27ml, 28ml. Dilute with ethylene chloride to the mark

$$\text{Weight of TNT in each standard solution} = A \times 0.016$$

where: A = Volume of TNT stock soln added to 50-ml volumetric flask

$$0.016 = \text{Weight of TNT (gms)/ml of TNT stock soln}$$

Prepare the TNT spectral calibration graph by detg the absorbance at 367 μ of the standard TNT solns at 20°C compared to a soln of 0.400g of TNT/50ml of ethylene chloride using 1 mm path cells. Plot absorbance against weight of TNT

4.4.3.5.2 Preparation of Wax Standard Solutions and Wax Refractive Index Calibration Graph.

Prepare 3-g HBX samples with different weights of wax and lecithin. The samples must be prepared with the same materials used to prep the HBX being analyzed. The weight of wax + lecithin in the sample is based on the wax from the D-2 and Comp B (if used). The standard wax samples are treated as described in 4.4.3.2.3 to obtn the wax in soln

Prepare the wax refractive index calibration graph by detg the refractive index of the various

solns of known wax concentration under the same conditions described in 4.4.3.2.3. Plot the refractive index readings from the samples against weight of wax + lecithin

4.4.3.5.3 Preparation of 0.1M Potassium Chromate Solution. Accurately weigh 1.942g of reagent grade K chromate into a 100-ml volumetric flask. Dilute to mark with distd w. Mix well

4.4.3.5.4 Preparation of 0.1N Silver Nitrate Solution. Accurately weigh 16.989g of reagent grade Ag nitrate into a liter volumetric flask. Dilute to mark with distd w. It is not necessary to standardize the Ag nitrate soln if care is taken in the prepn of the soln. Store the Ag nitrate soln in a dark place

4.4.3.5.5 Preparation of RDX Saturated Benzene. To a gallon of reagent grade benzene, add RDX in excess of solubility, and stir for several hours. Let stand overnight. The soln should be prepd and kept at the same temp as will prevail at the time of filtering the extracted sample. Filter soln just before use

4.4.3.5.6 Preparation of 20 Percent Solution of Ammonium Thiocyanate. Dissolve 60g of reagent grade ammonium thiocyanate (NH_4SCN) in 240ml of distd w. Filter until clear and store

4.4.3.5.7 Preparation of 6N Hydrochloric Acid. Add 250ml of reagent grade 38% HCl to 250ml of distd w. Mix well

4.4.3.5.8 Preparation of 0.2N Titanous Chloride Solution. Mix 150ml of 20% titanous chloride soln with 100ml of 38% HCl soln. (As the concn of the 20% titanous chloride varies from bottle to bottle, one may use an adjusted volume for the prepn of additional 0.2N Ti(III) soln rather than the 150ml of 20% soln). Dilute quantitatively to 1 liter with distd w. Mix by bubbling a stream of nitrogen or carbon dioxide gas thru the soln, filter thru Whatman No 41 (fluted) or equivalent paper, store in a system arranged so that only carbon dioxide or nitrogen gas will be drawn into the stock bottle as the soln is used. (Scientific Glass Apparatus Co JB-7670, burette, automatic, for titanous chloride solution, improved form; or JB-7615, burette, automatic, or equivalent is satisfactory. Teflon stopcocks are to be preferred).

4.4.3.5.9 Preparation of 0.15N Ferric Ammonium Sulfate Solution. Dissolve 75g of hydrated ferric ammonium sulfate ($\text{FeNH}_4(\text{SO}_4)_2 \cdot 12\text{H}_2\text{O}$), reagent grade, in 600ml distd w. Add to this 25ml of 95% reagent grade sulfuric acid. When dissolved, dilute with distd w to 1 liter; filter, mix thoroughly, and store

4.4.3.5.10 Preparation of 0.200N p-Nitroaniline Solution. Use p-nitroaniline with a mp of 147–148°C, and recrystallize once from ethanol. Dry in a desiccator. For a 0.200N soln weigh exactly 1.151g of recrystallized p-nitroaniline, dissolve in reagent grade glacial acetic acid, transfer to a 250-ml volumetric flask and dilute to the mark with glacial acetic acid. Mix well

4.4.3.5.11 Comparison of Titanous Chloride and Ferric Ammonium Sulfate Solutions (Determination of R). This value is necessary in the determination of the normality of the Ti(III) and the normality of the Fe(III). R equals the ml of Ti(III) reacting with 1.00ml of Fe(III) soln. Sweep the air from a 300-ml reduction flask with a current of nitrogen or carbon dioxide gas for 5 mins. Continue to pass the current of nitrogen or carbon dioxide gas thru the flask until the titration is completed

Pipette 50.00ml of approx 0.15N Fe(III) soln into the air free reduction flask. Add 25ml of 6N HCl (use a cylinder to measure the HCl). Titrate with approx 0.2N Ti(III) soln until near the end point (the Ti(III) color gets light). Add 5ml of 20% ammonium thiocyanate soln (by cylinder), and continue the titration until the red color just disappears. Repeat the procedure until two successive values for R agree to within 1 part per thousand of their mean

$$R = A/B$$

where: A = ml of Ti(III) soln

B = ml of Fe(III) soln

4.4.3.5.12 Standardization of 0.2N Titanous Chloride Solution. Sweep the air from a 300-ml reduction flask with a current of nitrogen or carbon dioxide gas for 5 mins. Continue to pass the current of gas thru the flask until the titration is completed

Pipette 20.00ml of the 0.200N p-Nitroaniline soln into the reduction flask. Pipette 25ml of titanous chloride approx 0.2N into the same flask. Add 25ml of 6N HCl (by cylinder), and a few glass beads. Connect the reduction flask to a reflux condenser and boil for 15 mins. Cool the flask to RT without disconnecting the condenser (lift the flask and condenser, remove the heater, and let the flask down into a pan of cold water)

Titrate the excess Ti(III) with Fe(III) soln. As the end point is approached, Ti(III) color gets light, add 5ml of 20% ammonium thiocyanate (by cylinder), as an indicator and titrate to the appearance of the red color. Run a blank, substituting

20ml of glacial acetic acid for the p-nitroaniline soln

$$\text{Normality of Ti(III) solution} = 4.000 / [(A-R)B - (C-R)D]$$

where: 4.000 = Millequivalents of p-nitroaniline in 20.00ml of 0.200N soln

A = ml of Ti(III) soln

B = ml of Fe(III) soln

C = ml of Ti(III) in blank

D = ml of Fe(III) in blank

R = ml of Ti(III) reacting with 1.00ml of Fe(III) soln

The term (C–RD) should be zero. If the value lies outside the range +0.10 and –0.10, either R is incorrect, or the acetic acid is contaminated. Repeat the detn of R. Continued high or low values for (C–RD) probably mean impure acetic acid

If normality of Ti(III) soln falls outside of the range 0.19–0.22, add 20% titanous chloride soln or water as required to bring normality to approx 0.2N. Then repeat the detn of R and repeat the detn of the normality

4.4.3.5.13 Determination of the Normality of the Ferric Ammonium Sulfate Solution. Using the value of R and the value of the normality of titanous chloride detd in 4.4.3.5.11 and 4.4.3.5.12, calculate the normality of the ferric ammonium sulfate soln

$$F = \text{Normality of Fe(III) soln} = (R) (N)$$

where: R = ml of Ti(III) soln reacting with 1.00ml of Fe(III) soln

N = Normality of Ti(III) soln

4.4.3.5.14 Preparation of Hot Melt Standard Solutions and Hot Melt Spectral Calibration Graph. Prepare a stock TNT soln by accurately weighing and transferring 8g of TNT into a 500-ml volumetric flask. Dilute to mark with ethylene chloride. Prepare a stock hot melt soln using material conforming to Specification MIL-C-3301. Accurately weigh and transfer 0.45g of hot melt into a beaker and dissolve in a 100ml of ethylene chloride. Filter soln thru a sintered glass filtering crucible, medium porosity, 30-ml capacity until filtrate shows no sign of sedimentation

To det weight of hot melt per ml of filtrate, accurately pipette 15ml of filtrate into a tared evaporating dish with cover. Evaporate to dryness on a steam bath or hot plate below 75°C. Replace cover, cool in a desiccator to RT and weigh

$$\text{Weight of hot melt per ml of solution} = (A-B) / V$$

where: A = Wt of evaporating dish plus cover plus residue

B = Wt of evaporating dish plus cover

V = Volume of hot melt filtrate pipetted into evaporating dish

Into each of six 50-ml volumetric flasks, pipette accurately 25ml of the TNT stock soln, add to each of the flasks respectively, by pipetting accurately, 0.5ml, 1.0ml, 1.5ml, 2.0ml, 2.5ml, 3.0ml of the hot melt filtrate. Dilute with ethylene chloride to the mark

Weight of hot melt in standard = WD

where: W = Wt of hot melt per ml of soln

D = ml of hot melt added to the standard

Prepare the hot melt spectral calibration graph by detg the absorbance at 430mu of the standard hot melt and TNT solns at 20°C compared to a soln of 0.400g of TNT/50ml of ethylene chloride using 1 mm path cells. Plot absorbance against weight of hot melt

4.4.3.5.15 Preparation of the TNT Correction Graph for the Presence of Hot Melt. Determine the spectral absorbance of the hot melt and TNT standard solns at 367mu, at 20°C, using 1 mm path cells. The prepn of the solns is described in 4.4.3.5.13. From this data determine the apparent weight of the TNT from the TNT spectral calibration graph described in 4.4.3.5.1. Subtract the actual weight of TNT (0.4g) in the standard hot melt soln from the apparent weight of TNT. This gives the TNT correction value

Determine the spectral absorbance of the hot melt standard solns at 430mu as described in 4.4.3.4.14

For the TNT correction graph for the presence of hot melt plot the absorbance of the standard hot melt solns at 430mu against the TNT correction values obt'd at 367mu

4.4.4 Moisture Determination. Remove sample of HBX from closed sample container. Sample size shall be approx 100g for Grade A material and 50g for Grade B material. Break up quickly and transfer the sample to a tared liter Erlenmeyer flask with a ground glass neck. Stopper flask and record weight of flask plus sample. (When sample is broken up, it should be exposed to the air as little as possible as the Ca chloride in the HBX quickly takes up moisture)

To the flask containing the sample add 200ml of toluene and a magnetic stirring bar. Attach flask to a Bidwell-Sterling trap (graduated 5ml

in 0.1ml). To the top of the trap is attached a cold water condenser. (See Figure 1). (The use of Teflon sleeves on the ground glass joints in place of a lubricant will facilitate the cleaning of the glassware)

Heat the assembly on a magnetic stirrer hot plate, with agitation provided by the magnetic stirrer. Heat to boiling. (The toluene-water azeotrope condenses and falls back into the trap. Water being heavier, collects in the trap and the excess toluene returns to the boiling flask). Continue boiling until no change in the water volume has been observed for 15 mins. Boil a minimum of 1 hour

CAUTION: Keep soln well agitated at all times. When soln begins distilling, position flask so that an air space is between the flask and hot plate. This is to prevent a hot spot from building up in the chunk explosive. Sample should not be left unattended during the moisture detn. Care must be taken that the cold water condenser is operating properly at all times. If the condenser should fail to trap the toluene and the flask were to boil dry, there could be a possibility of overheating the expl

Care should be taken to prevent condensation of atmospheric moisture in the condenser. Five minutes before heating is discontinued wash down the condenser with toluene to remove any water clinging to the tip of the condenser

After the moisture has been collected, transfer the trap to a constant temp bath at 40°C ± 2°C. Allow about 30 mins for trap contents to reach the temp of the bath. By means of a wire loop work any droplets of water trapped along the side to the bottom of the trap. Read the volume of the water collected

Run a blank on the toluene to det water present in the toluene. Calculate the percentage of water in the sample

$$\text{Percentage of water} = [(A-B) \times C \times 100] / W$$

where: A = ml of water

B = ml of water in toluene

C = Density of water at temp of the water bath

W = Wt of the sample

4.4.5 Vacuum Stability Test, 100°C

4.4.5.1 Calibration of Glass Tube. Determine the volume in mls of the 15.5cm heating tube by running in mercury from a buret until the tube is filled to the level at which the ground glass

joint of the capillary tube will make contact with the mercury. Subtract from the indicated buret reading, the volume of expl used in the test. The difference shall be represented by the symbol A. Transfer 7.0ml of mercury to the cup at the lower end of the capillary tube. Clamp the tube in an upright vertical position, and measure the height in mm of the mercury column in the capillary tube (approx 25mm). Measure the length in mm of each of the 3 parts of the capillary tube and add these values to obtain total length. From the total length subtract the height of the mercury column in the capillary tube as previously obtained. Represent this difference by the symbol B₁. From the total length subtract the height of the column of mercury in the capillary tube measured at the end of the test described in 4.4.5.1

Represent this difference by the symbol B. Determine the capacity of the capillary tube per unit of length as follows: Transfer an accurately weighed sample of approx 10g of mercury to the cup at the lower end of the capillary tube. Manipulate the tube so that when it is horizontal, mercury is contained in a continuous section of the longest part of the tube and measure the length of the mercury column. Repeat this twice with the mercury in 2 other parts of the long section of the tube. Calculate the average of the 3 measured lengths of the mercury column. Represent the unit capacity in ml per mm of the capillary tubing by the symbol C. This can be obtained from the formula:

$$C = W / d\bar{l}$$

where: C = Unit capacity of capillary tubing in ml per mm

W = Grams of mercury

d = Density of mercury at temp of determination

\bar{l} = Average measured lengths of mercury column in mm

4.4.5.2 Test Procedure. Transfer a 1 g sample, dried at 65°C for 2 hours, to the heating tube of the apparatus shown in Figure 2. Connect the capillary tube to the heating tube. Clamp the apparatus so that the long section of the capillary tube is in a nearly vertical position. Transfer 7.0ml of mercury to the cup at the lower end of the capillary tube. Connect a vacuum pump to the lower end of the capillary tube and evacuate the system until the pressure is reduced to approx 5mm of mercury. (Evaluation of the capillary

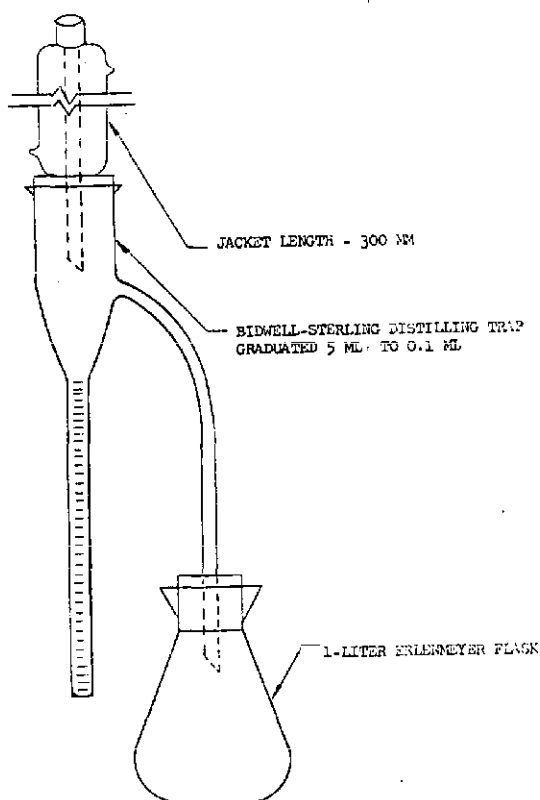

FIGURE 1 Moisture content apparatus

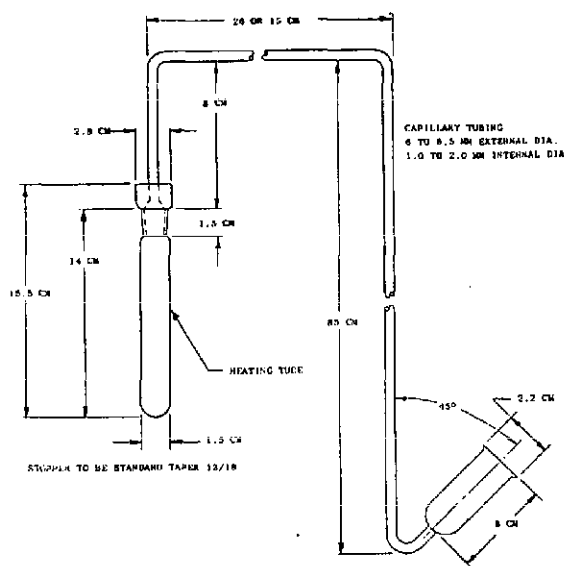

FIGURE 2 Apparatus for 100°C vacuum stability test

tube is facilitated by placing the cup of the tube in a horizontal position so that mercury does not block the capillary opening). After evacuation, disconnect the pump. Seal the connection between the capillary tube and the heating tube with 1 ml of mercury. Measure the total vertical height of the column of mercury in the capillary tube. Measure and subtract the vertical height of the mercury in the cup. The difference shall be represented by the symbol H_1 . Note the RT (t_1) and the barometric pressure. Subtract the value H_1 from the barometric pressure in mm. Represent this difference by the symbol P_1 . Insert the heating tube in a constant temp bath consisting of a soln of glycerin and water (sp gr 1.05). Maintain at a temp of $100.00^\circ\text{C} \pm 0.5^\circ\text{C}$ for 48 hours. Remove the heating tube from the bath and allow to cool to RT. Measure the total vertical height of the column of mercury in the capillary tube and subtract the vertical height of the mercury in the cup. This difference shall be represented by the symbol H . Note the RT (t) and the barometric pressure in mm. Represent this difference by the symbol P

4.4.5.3 Calculation of Liberated Gas Volume.

Calculate the gas vol in ml (at standard conditions) liberated in the test described in 4.4.5.2, using the values described by the symbols in 4.4.5.2 and 4.4.5.1 in the following formula:

$$V = \frac{[A+C(B-H)] \times 273P}{760(273+t)} - \frac{[A+C(B_1-H_1)] \times 273P_1}{760(273+t_1)}$$

6.3 General Safety Precautions. The preparation and handling of the items covered by this specification, and the subassemblies thereof, involve hazardous operations and therefore require explosives safety precautions. Use of this specification will not be construed as to relieve the contractor or manufacturer of responsibility for the safety of his operations. Listed below are certain minimum provisions which a contractor or manufacturer (who prepares the item covered) should observe in order to fulfill his responsibility for safety. At Bureau of Naval Weapons, Navy Department, and other government plants, these provisions are mandatory. Such other warnings and precautions, pertinent to the operational effectiveness or safety during preparation of the specified items, are included in detailed technical requirements of the specification

6.3.1 All handling and bathing operations should be conducted in a neat and orderly manner

6.3.2 Safe equipment and methods should be utilized for transporting and handling explosives components and mixtures. Where required, remote controlled barricaded handling equipment shall be used for explosives operations, such as mixing, pouring, weighing, charging, sifting, drying, casting, etc

6.3.3 The exposure of explosive materials and related parts should be so controlled as to minimize the absorption of moisture from the atmosphere or other sources during handling and batching operations

6.3.4 All explosive components and mixtures should be stored in suitable storage magazines located in accordance with American Table of Distances (ATD) or other applicable safety standards; and while in process, in safety lockers and chests if in loading rooms, or in adequate ready or service magazines located in accordance with Intraplant distances when outside of loading rooms. For Navy managed explosive loading plants, the provisions of the Armed Services Explosives Safety Board covering quantity-distance relations for explosives will apply

6.3.5 Proper care must be exercised at all times to protect personnel from accidents, fires, or explosions, and to limit damage to equipment and loading areas. In this connection, the precautionary measures in the following paragraphs should be observed

6.3.5.1 Employ properly proportioned and properly located protective barricades, screens or shields at all required points

6.3.5.2 Keep only minimum limited quantities of explosives components and expl mixtures at each stage of operations

6.3.5.3 Keep explosives and expl components in approved covered receptacles with covers in place when material is not being taken out of or put into the receptacles. Where necessary, receptacles should be conductive to ground electrostatic charges

6.3.5.4 Protect operations from electrostatic charges by effectively grounding all machinery, equipment and fixtures; and, where necessary, employ suitable grounded conductive coverings for floors, work benches and tables, and workers' conductive shoes. Workers' clothing of a type to minimize the accumulation of static charges

should be employed. Fabrics such as silk and nylon, which promote static generation should be avoided. Additional precautions should include mechanical shielding to contain fragments and blast, also electrical shielding from induced electric currents generated by sources such as lightning, static, radiations from communications apparatus, radar, or high frequency heat apparatus, etc. Additional grounding devices such as grounding bracelets for workers should be employed where operations are conducted with items which are unusually sensitive to initiation by static electricity. Where necessary for safety, humidity of work rooms should be appropriately increased, as required, to lessen electrostatic effects but without inducing excessive moisture absorption by any of the components

6.3.5.5 Protect all expl operations from effects of electric current originating from equipment such as soldering irons, heaters, switches, wiring, motors, lights, test instruments, etc, by suitable insulation, grounding, separation or shielding. Such electric sources may initiate expls by heat, sparks, arcs. Circuits may be inadvertently completed, for example: from a defective soldering iron thru a ground contact

6.3.5.6 Enforce, where necessary, the wearing of suitable safety footwear, gloves, goggles, respirators, and impregnated garments to protect personnel against burns, poisoning, and associated industrial hazards

6.3.5.7 Allow no fires or exposed electrical or other sparking equipment, and little or no flammable material to be present in loading, handling and storage spaces. Enforce proper "Match" and "No Smoking" rules where necessary

6.3.5.8 Enforce good housekeeping and maintain effective policing, inspection and supervisory methods thruout the loading area and surroundings. Employ effective cleaning methods periodically to minimize the accumulation of explosives and explosives dust and other contaminants upon, and assure its removal from floors, walls, celings, ledges, tables, benches, piping and equipment or the item loaded; also, clean up any spilled material immediately

6.4 Manufacture by Government Activities. When the HBX type explosive compns are to be prepd in accordance with this specification by government activities, the requirements given herein for bidders and contractors shall apply to such government activities

HBX-1 Analytical Procedure. Pristera (Ref) briefly describes its analysis as follows: Extract TNT wax and lecithin with carbon tetrachloride; then determine TNT by titanous reduction as described on p 466 of Ref; extract with water the Ca chloride from carbon tetrachloride insoluble residue and extract RDX, with hot toluene, from water-insol residue using Wiley extractor. Extract NC from toluene-insol residue with cyclohexanone, acetone, or tetrahydrofuran; the remainder is Al

Ref: Frank Pristera, "Explosives" in Encyclopedia of Industrial Chemical Analysis, Wiley, NY, Vol 12 (1972), pp 448 & 466

HBX-3 Analytical Procedure. Accdg to Pristera, the procedure is the same as for HBX-1. The procedure was also described by S. Semel et al in PATR 2459 (1957), entitled "A Chemical Method for the Composition Analysis of Cast HBX-3"

H-6 Analytical Procedure. Accdg to Pristera, the procedure is the same as for HBX-1

Note: No description of Analytical Procedures for HBX-1, HBX-3 and H-6 found in Standard Methods of Chemical Analysis, Vol 2B (1963)

HC Mixture. A German smoke screen mixture which partly replaced the less stable BM Mixture during WWI. The HC mixture contains Zn dust and hexachloroethane (solid) along with relatively small percentages of NH_4Cl , NaClO_4 , and Mg CO_3 . It is stable, safe and easily handled, but its cost is comparatively high. It was used in candles, the 4-inch Stokes mortar-shell (burning type) and HC grenades
Refs: 1) H.W. Walker, IEC 17, 1064 (1925)
2) Anon, Field Artillery Journal 33, 352 (1943)

HDP Supergun. See Hochdruckpumpe or V-3 (Vergeltungswaffe Drei)

HE. Abbr for High Explosives

Headaches Arising from Contact with NG or Dynamites. Test exposure (oral and skin contact) to a 20% NG Dynamite produced severe headaches, nausea and vomiting. These effects are ascribed to intracranial vasodilation produced by the NG vapors or liquid. Headaches were alleviated by intramuscular injection of caffeine-Na-benzoate followed by oral administration of

amphetamine sulfate. Headaches were prevented by daily oral administration of amphetamine sulfate for 2 or 3 days prior to NG exposure (Ref 1)

Reaction to NG among pharmaceutical workers is described. Included in the discussion are physiological actions, susceptibility and habituation, toxic effects and methods of control (Ref 2)

NG headaches are ascribed to distention of intracranial veins or reduction of venous tone or insufficient tone resulting from enhanced arterial blood flow (Ref 3)

Refs: 1) A.M. Schwartz, *New England J Med* **235**, 541-4 (1946) & *CA* **41**, 285 (1947)
2) R.N. Bresler, *Ind Med* **18**, 519 (1949) & *CA* **44**, 912 (1950) 3) V.P. Zhururkin; *Zh Nervopatoli Psikhiat* **67**, 1336 (1967) (Russ) & *CA* **67** 11576 (1967)

Health Hazards of Explosives and Propellants.

Health hazards may be encountered in the manufacture, handling and use of explosives and propellants. These hazards vary with materials and degree of exposure and can range from mild dermatitis to severe poisoning

More serious than dermatoses caused by skin contact with Tetryl, TNT, DNT, Hg-Fulminate, solvents etc, during explosives and ammunition production, are exposures to toxic dusts, fumes and vapors. Among these are TNT, DNT, oxides of N, Pb-dusts and vapors, and solvent vapors. Special skin cleansing agents and solns for detecting these harmful materials on the skin are discussed in Ref 1.

In propellant and missile productions health hazards may arise from contact with: ammonia, aniline, MeOH, furfuryl alc, hydrazine, JP-4, hydrogen peroxide and red fuming nitric acid (Ref 2), as well as other propellant ingredients such as NG, epoxy comps, polyurethanes, Amm Perchlorate etc (Ref 5)

In actual field use explosion product fumes can be hazardous, eg Ammonium Nitrate-fuel oil mixtures (ANFO) are not recommended for underground blasting because they produce toxic fumes (Ref 3). Highly toxic NO is often found in explosion fumes. The oxidation of NO to the less dangerous NO₂ was found to be less rapid under mining conditions than was previously believed (Ref 4)

Refs: 1) W.J. McConnell, *Ind Hyg-Foundation Am Inc Proc 8th Annual Meeting* (1943), 20-2 & *CA* **38**, 3040 (1944) 2) S. Krop, *Jet Propulsion* **24**, 223 & 236 (1954) & *CA* **48**, 13221 (1954) 3) R.W. Van Dolah et al, *Miss Univ School of Mines & Met Bull Tech Ser No* **98**, 90-100 (1960) & *CA* **55**, 4963 (1961) 4) C.W. Kraul & R.H. Duguid, *Arch Environmental Health* **3**, 680 (1961) & *CA* **56**, 7652 (1961) 5) J.E. Boysen, *Ibid* **7** (1), 71 (1963) & *CA* **60**, 1031 (1964)

HEAT. Abbr for High Explosive Antitank

Heat (Definitions and Selected General References)

A form of energy. The mean energy transferred from one system to another system as a result of purely thermal interactions (temperature gradients) is called *heat*

Refs: 1) J.A. Randall "Heat", J. Wiley and Sons, New York (1913) 2) T. Preston & J.R. Cotter "Theory of Heat", Macmillan and Co., London (1919) 3) G.N. Lewis & M. Randall "Thermodynamics", McGraw Hill, New York (1923) 4) J.R. Partington & W.G. Shilling "Specific Heats of Gases", E. Benn Ltd, London (1924) 5) W. Nernst "The New Heat Theorem", Dutton and Co, New York (1926) 6) W.H. McAdams "Heat Transmission", McGraw Hill, New York (1933) 7) R.R. Wenner "Thermochemical Calculations", McGraw Hill, New York (1941) 8) J.M. Cork "Heat", J. Wiley, New York (1942) 9) J. Reilly & W.N. Rae "Physicochemical Methods", Van Nostrand, New York (1943) 10) H.S. Carslaw & J.C. Jaeger "Conduction of Heat in Solids", Clarendon Press, Oxford (1947) 11) M. Jacob, "Heat Transfer", J. Wiley & Sons, New York, V. 1 (1949) 12) D.Q. Kern "Process Heat Transfer", McGraw Hill, New York (1951) 13) F. Reif "Fundamentals of Statistical and Thermal Physics", McGraw Hill, New York (1965)

Heat of Adsorption (see also Adsorption). The heat released when a gas is adsorbed on a surface. The differential heat of adsorption is given by:

$$Q_{\text{diff}} = \Delta \bar{H}_g - \Delta \bar{H}_{\text{ads}}$$
 where $\Delta \bar{H}_g$ and $\Delta \bar{H}_{\text{ads}}$ are *heat contents* or *enthalpies* (see below) of the gas and adsorbed phases.

Refs: 1) R.A. Beebe et al, JACS **58**, 2196 (1936); **59** 1627 (1937); **60**, 2912 (1938) & **62** (1940) 2) S. Glasstone, "Textbook of Physical Chemistry", Van Nostrand, New York (1940), 1179 3) S.J. Gregg, JChemSoc (1946), 563: (Description of an apparatus which is a combined sorption balance and calorimeter for simultaneously measuring adsorption isotherms and heats of adsorption) 4) H. Weissberger, "Physical Methods of Organic Chemistry", Interscience, New York 2nd ed V1 part 1 (1949) pp 815-817 5) D.F. Eggers et al, "Physical Chemistry", Wiley and Sons (1964), p 731 & 741

Heat Capacity is the ratio of the heat absorbed to the rise in temperature for an infinitely small increase in temperature. For a process occurring at constant volume the heat capacity $C_v = (\delta E / \delta T)_v$ where δE is the internal energy change of the process over a temperature change δT . Similarly for a constant pressure process $C_p = (\delta H / \delta T)_p$ where δH is the change in heat content (enthalpy) of the process. When dealing with a unit weight of a substance, a small (*c*) is employed and this ratio is also known as *specific heat*. In cgs units *c* is given in calories per gram per degree. For many organic explosive compounds $c \approx 0.3$ cal/g-° at rm temp

Refs: 1) G.N. Lewis & M. Randall, "Thermodynamics," McGraw Hill, NY (1923) 2) J.M. Perry, Chemical Engineers' Handbook, McGraw-Hill, NY (1950), pp 219-235

Heat of Combustion. See Vol 4, p D369 (Tables D380-1) of Encycl under DETONATION (AND EXPLOSION), DEFLAGRATION (AND COMBUSTION), AND FORMATION, HEATS OF

Heat of Condensation is the reverse of Heat of Evaporation or Vaporization (See under Heat, Latent)

Heat Conductivity, Specific or Coefficient of Thermal Conductivity (λ) is the quantity of heat in gram-calories transmitted per second through a plate of material one centimeter thick and one square centimeter in area, when the temperature differential between the two sides is 1°C. When it is desired to express it in Btu

per inch/second/degree F, the above value has to be multiplied by 0.00560

If two opposite faces of a cube, made from the substance to be examined, are maintained at temperatures (T_1) and (T_2), the heat conductivities across the section of the cube (A) cm^2 and (D) cm thick, the specific heat conductivity:

$$\lambda = \frac{K(T_2 - T_1) At}{D}$$

where (K) is a constant depending on the nature of the substance and (t) is the time in seconds. See Table 4 of this Vol for heat conductivities of common explosives

Ref: H.S. Carlslaw & J.C. Jaeger, "Conduction of Heat in Solids," Oxford Press (1947)

Heat Content or Enthalpy. A thermodynamic property closely related to energy. It is defined by $H = E + PV$ where E is the internal energy of the system, P is the pressure on the system and V is the volume of the system. Often it is used in differential form as in $\Delta H = \Delta E + P\Delta V$ for a constant pressure process

Heat of Crystallization. The number of calories liberated or absorbed per mol, or gram when a substance passes into the crystalline state. In cases of solidification of crystalline compounds, the heat liberated on freezing may be considered as the heat of crystallization

Heat of Decomposition. The heat evolved or absorbed in a particular decomposition process. Thus the heat of decomposition of $A \rightarrow B + C$ is usually different from $A \rightarrow B + D$. However, $A \rightarrow E + F \rightarrow B + C$ has the same *net* heat effect as $A \rightarrow B + C$. The heat of decomposition is generally expressed in kg calories per gram molecule or in calories per gram

Heat of Deflagration. See Vol 4 of Encycl under DETONATION (EXPLOSION, DEFLAGRATION, COMBUSTION AND FORMATION) HEATS OF, p 374-R

Heat of Detonation. See Vol 4 of Encycl pp D 370 to 375

Heat of Dilution. Is the quantity of heat consumed or liberated when a solution is diluted

Heat of Dissociation is the heat involved in the disruption of a chemical bond

Heat of Dissolution or of Solution is the quantity of heat liberated or absorbed when a solid is dissolved or two miscible liquids are mixed

Heat Effects — Data for Common Explosives.
The data required for computing various heat effects involving explosives and explosions are: standard heats (also called enthalpies) of formation, heats of detonation (or explosion), heats of fusion, vaporization and/or sublimation, heat conductivity, and specific heat. Tables of these data for common explosives are given below. Examples of the use of these data are shown in the next section. In conformance with modern usage *exothermic* heat effects have a *negative* sign

Heat Effects — Examples of the Use of Heat Data for Estimating Heat Effects in Explosives and Explosions.

1) *Heat of nitration of glycerin.* Suppose we wish to estimate the heat evolved in nitrating 1 mole of glycerin with mixed acid. To simplify this illustrative example we will assume: initial mixture — 1 mole glycerin/3 moles 100% nitric acid/6 moles 100% sulfuric acid; final mixture — 1 mole nitroglycerin completely separated from the spent acid which is now diluted by 3 moles of water; the entire heat of dilution is due to 3 moles water dissolving in 6 moles of 100% sulfuric acid. Thus

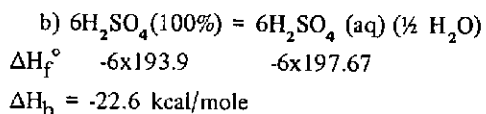
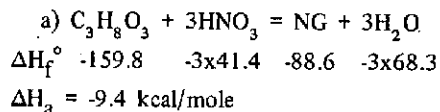

The net heat effect is $\Delta H_a + \Delta H_b = -32$ kcal/mole glycerin, most of which comes from the heat of dilution of H_2SO_4 . The ΔH_f° 's for these calculations were taken from Table 1 and Refs 1 & 7

2) *Heat of detonation.* Price (Ref 3) has shown that the heat of detonation of an explosive correlates well with the blast effects

(shock, impulse and bubble energy) that the explosive produces in air and underwater. This correlation is confirmed in Ref 9, where it is also pointed out that explosive power, as measured in the ballistic mortar or lead block, can be related to the heat of detonation.

Furthermore, heat of detonation can be an important parameter in establishing the equation of state of detonation products or in thermal explosion calculations. Consequently, the heat of detonation is an important property of an explosive and methods of its accurate evaluation can contribute greatly to explosive technology

To obtain the true value of the heat of detonation one must know the composition of the detonation products at C-J conditions. At present such compositions can be obtained only by theoretical calculations. These calculations depend strongly on the choice of the equation of state of the detonation products. For military CHNO explosives the main equilibria that determine product composition are (Ref 9):

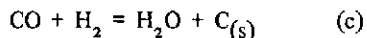
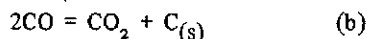
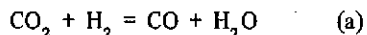

and

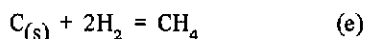
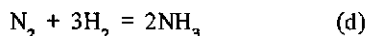

if the equil mixture of (a), (b) and (c) contains appreciable amounts of H_2 . Of these equilibria only (a) is relatively independent of pressure and only moderately dependent on temperature in the expected TCJ range. For oxygen-balanced explosives equil (a) is controlling. Thus, the composition of detonation products of oxygen-balanced explosives should be nearly independent of the choice of eqn of state

For military explosives that are deficient in oxygen (negative OB), equil (b) and (c) must be considered and the choice of eqn of state becomes important. Currently the BKW eqn of state (see Vol 4, p D284) is used for most calculations, eg Ref 4. From Mader's calcs (Ref 4) combined with the ΔH_f° 's of Table 1, the heats of detonation of NG, PETN, HMX, RDX, PBX 9404, LX-04, TNT and NM are

respectively: 1.48, 1.51, 1.475, 1.48, 1.41, 1.31 (Ref 10), 1.24 and 1.30 kcal/g. These values are to be compared with experimental ΔH_d 's (for heavily confined samples) (Tables 1 and 2) of: —, 1.49, 1.48, 1.42, 1.38, 1.31, 1.09 and 1.23 kcal/g. This excellent agreement between theory and experiment (except for TNT) is really quite amazing. Theory considers H_2O as gaseous, whereas it is liquid in the calorimeter. Furthermore, the detonation product composition in the calorimeter is some frozen equilibrium composition (probably corresponding to a freeze-out temperature of $\approx 1600^\circ K$), while CJ temperatures are of the order of 2000-4000°K. What appears to be happening in the confined calorimeter samples is a series compensating heat effects namely: $H_2O(g) \rightarrow H_2O(l)$ and $N_2 + 3H_2 = NH_3$ exothermic & the partial reversal of equil (b) & (c) (decrease of C_s) endothermic. Also at $T \sim 1600^\circ K$ equil (a) is shifted towards CO_2 as compared to T_{CJ} which tends to counteract to some extent the reversal of equilibria (b) and (c)

For a quick approximate computation of the heat of detonation of military CHNO explosives, the following is suggested (Ref 9) for obtaining an approximate product composition:

All H $\rightarrow H_2O(g)$; all remaining O is used to form CO_2 ; any remaining C $\rightarrow C(s)$; all N $\rightarrow N_2$

As an example of the use of this approximate method, let us estimate ΔH_{det} for Haleite (EDNA):

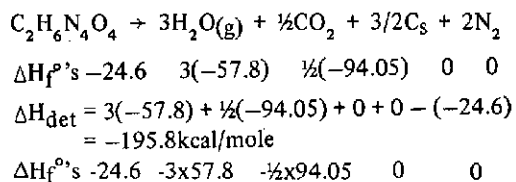

$\Delta H_{det} = 195.8$ kcal/mole = 1.30 kcal/g which compares amazingly well with a reported measurement (Ref 6) of 1.3 kcal/g

3) *Heat of decomposition.* Since the products of a relatively slow ("low" temp) decomposition of an explosive will often be quite different from deton products, it is not surprising that $\Delta H_{decomp} \neq \Delta H_{det}$. Hall (Ref 8) measured the decomposition of solid nitramines in the temp range of 365-540°K. In the following tabulations some of his data are compared with ΔH_{det} taken from Table 1

Expl	ΔH_{decomp} (kcal/g)	ΔH_{det} (kcal/g)
HMX	0.56 at $\sim 540^\circ K$	1.48
RDX	0.61 at $\sim 479^\circ K$	1.42
Tetryl	0.33 at $\sim 445^\circ K$	1.17

4) *Heat Balance in Estimating Critical Dimensions for Thermal Explosion.* For thermal explosion to occur the rate of heat generation must exceed the rate of heat loss. The general equations for this situation can be solved only by numerical means. Specialized cases are, however, amenable to analytical solutions. An interesting case is that of a semi-infinite slab of explosive for which Friedman (Ref 5) obtained a series of approximate analytical solutions. These enable one to estimate the critical thickness of the slab and the time to explosion as functions of the initial slab temperature and the kinetic and thermal parameters of the explosive

The approximate equations in dimensionless form are:

$$a_{cr}^2 \cong 4\theta_0 \exp(1/\theta_0) \ln[0.608(\theta_0 - \theta_1)/\theta_0^2] \quad (1)$$

$$\tau_0 \cong \theta_0^2 \exp(1/\theta_0)/a_{cr}^2 \quad (2)$$

and

$$\theta_0 = RT_0/E \quad \& \quad \theta_1 = RT_1/E \quad (3)$$

$$d^2 = a_{cr}^2 \lambda E / \rho R Q Z \quad (4)$$

$$t_0 = \tau_0 c \rho d^2 / \lambda \quad (5)$$

where T_0 is the slab temp, T_1 = ambient temp, E&Z are the activation energy and frequency factor of the explosive, and λ , ρ , c and Q are its thermal conductivity, density, specific heat and heat of reaction. The quantities d and t_0 are respectively the critical $\frac{1}{2}$ thickness of the slab and the time to explosion at T_0 if the process is adiabatic

To illustrate the use of the heat data in the preceeding section for estimating thermal explosion parameters, let us determine the critical thickness of a semi-infinite slab of Tetryl kept at 445°K. From Ref (2) we take $E \cong 35000$ cal/mole and $Z \cong 10^{13} \text{sec}^{-1}$. Substituting these values in eqn (3) and then into eqns (1) and (2) gives:

$$a_{cr}^2 = 3.24 \times 10^{15} \quad \& \quad \tau_0 \cong 0.032$$

Now taking $Q = 330$ cal/g (Ref 8) and the other thermal data from Table 4, solutions of eqns (4) and (5) lead to:

$$d = 5.4 \text{ cm and } t_0 \cong 132 \text{ sec at}$$

$$T_0 = 445^\circ\text{K and } \rho = 1.6 \text{ g/cc}$$

In qualitative terms this means that quite a thick slab of Tetryl must be heated to around 170°C for over 2 minutes before explosion occurs

Written by J. ROTH

Refs: 1) F. Rossini et al, NBS Circ 500 (1952)
2) Cook (1958), 178 3) D. Price, ChemRev
59, 801 (1959) 4) C.L. Mader, LASL, LA
2900, July 1963 5) M.H. Friedman, Combustn
& Flame 11, 239 (1967) 6) See Ref 12 of
Table 1 7) See Ref 14 of Table 1 8) P.G.
Hall, Trans Farad Soc 67, 556 (1971) & CA 74,
103822 (1971) 9) Anon, "Principles of Ex-
plosive Behavior", AMCP 706-180 (April 1972)
10) UCRL-51319 "Props of Chem Expls and
Expl Simulants", Dec 1972

Table 1
Standard Heats of Formation and Heats of Detonation of Common Explosives

EXPLOSIVE		ΔH_f°		ΔH_{det}	
Chemical Name	Code or Common Name	kcal/mole	Ref	kcal/g	Ref
Bis (trinitroethyl) nitrazine	BTNEN	-76.9	12	1.50	4
Bis (N,N-trinitroethylurea)	BTNEU	-32.7	12	—	—
1,3-Diamino-2,4,6-trinitro-benzene	DATB	-29.8	15	1.01	9
4,6-Dinitro-2-diazophenol	DDNP	-27.8	8	≈0.8(d)	14
Diethyleneglycoldinitrate	DEGDN	-102(a)	14	≈0.8(d)	14
Diethanolnitraminedinitrate	DINA	-78(a)	12	—	—
2,4-Dinitrotoluene	DNT	-17.1	13	—	—
Ethylenedinitramine	EDNA or Haleite	-24.6	13	≈1.3(d)	14
Ammonium Picrate	ExplD	-92.7	13	≈0.8(d)	14
Bis (2,2-dinitro-2-fluoroethyl) formal	—	-178.8	11	1.28	11
Cyclotetramethylenetetramine	HMX	+17.93	12	1.48	11
Cyclotrimethylenetrinitramine	RDX	+14.71	12	1.42	3
				1.38(c)	9
Hydrazine Nitrate	HN	-60.5	4	0.88(e)	10
2,2',4,4',6,6'-Hexanitroazobenzene	HNAB	+57.8	17	—	—
Hexanitrostilbene	HNS	+13.8	13	—	—
Lead Azide	LA	+115.8	7	0.40	7
Lead Trinitroresorcinate	Lead	+204(a)	8	—	—
	Styphnate (LSt)	+107(a)	5	—	—
Mercury Fulminate	MF	+65	14	≈0.4(d)	14
Nitrocellulose	NC				
dinitro		-180(b)	1	—	—
trinitro		-156(b)	1	≈1.1(d)	14
Nitroglycerine (ℓ)	NG	-88.6	13	1.48(e)	10
Nitroguanidine	NGu	-22.1	13	≈0.7(d)	14
Nitromethane (ℓ)	NM	-27.03	13	1.23	11
Mannitolhexanitrate	Nitromannite	-154(a)	12	≈1.5(d)	14
Pentaerythritoltetranitrate	PETN	-128.7	13	1.49	11
Pentaerythritoltrinitrate	Petrin	-128(a)	13	≈1.2(d)	14
		-133(a)	6	—	—
2,4,6-Trinitrophenol	Picric Acid (PA)	-51.3	13	1.00(c)	4

Table 1 (Continued)
Standard Heats of Formation and Heats of Detonation of Common Explosives

EXPLOSIVE Chemical Name	Code or Common Name	ΔH_f°		ΔH_{det}	
		kcal/mole	Ref	kcal/g	Ref
Tetranitro-1,2,5,6-tetrazadibenzo- cyclooctatetrene	TACOT	+128	17	0.98(c)	17
1,3,5-Triamino-2,4,6-trinitrobenzene	TATB	-36.9	14	—	—
Triethyleneglycoldinitrate	TEGDN	-151(a)	2	—	—
2,4,6-Trinitrophenylmethylnitramide	Tetryl	+6(a)	13	1.14(c)	9
1,3,5-Trinitrobenzene	TNB	-8.9	15	—	—
Tetranitromethane (l)	TNM	+8.9(a)	13	—	—
2,2,2-Trinitroethyl-4,4,4- trinitrobutyrate	TNE	-118.6	4	1.47	4
2,4,6-Trinitrotoluene	TNT	-16.0	13	1.09	11

- (a) Uncertain
 (b) Per monomer unit
 (c) Unconfined or lightly confined — these are really $\Delta H_{exp|n}$ and not ΔH_{deton}
 (d) Conditions of measurement are unknown
 (e) Computed; for these oxygen-balanced materials the computed H_d should be nearly independent of the eqn of state of the deton products

Refs: 1) R.S. Jessup & E.J. Prosen NBS J of Res **44**, 392 (1950) 2) P. Tavernier, MP **38**, 329 (1956) & CA **51**, 15952 (1957) 3) A. Ya. Apin & Yu A. Lebedev, Dokl Akad Nauk SSSR **114**, 819 (1957) & CA **52**, 3345 (1958) 4) NAVORD Rept 2986 Sect D2 (1958 Suppl) 5) Quoted in Bowden & Yoffe (1958), p 152 6) Priv comm from ABL (1958) 7) B.L. Evans et al, Chem Rev **59**, 546 (1959) 8) B. Glowiak, Chem Stosowana (Poland) **5**, 575 to 98 (1961) & CA **57**, 3687 (1962) 9) LRL, Gen Chem Tech Note Number 128 "Props of Chem Expl", June, 1963 10) C.L. Mader, LASL, LA 2900, July, 1963 10a) N.O. Holland, Editor, "Explosives — Effects and Properties", NOLTR **65-218** (Feb 1967), Sect D 11) D.L. Ornellas, JChemPhys **72**, 2390 (1968) & CA **69**, 53315 (1968) 12) D.R. Stull, E.F. Westrum & G.C. Sinke, "The Chemical Thermodynamics of Organic Compounds", Wiley, NY (1969) 13) J.D. Cox & G. Pilcher, "Thermochemistry of Organic and Organometallic Compounds", AcadPress, NY (1970) 14) AMCP **706-177**, "Props of Expls of Military Interest" (1971) 15) Priv comm quoted by R. Shaw, JPhysChem **75**, 4047 (1971) 16) N.D. Lebedeva et al, ZhFizKhim **45**, (4), 980, (1971) & CA **75**, 11145 (1971) 17) UCRL-51319, "Props of Chem Expls and Expl Simulants", Dec 1972

Tables of Heat-data are presented below:

Table 2
Standard Heat of Formation and Heats of
Detonation of Explosive Mixtures

	ΔH_f° cal/g	Ref	ΔH_{det} kcal/g	Ref
Baratol	-708	1	—	—
Comp B-3	+11	2	1.20(a)	1
Comp C-4	+33	—	—	—
LX-04(b)	-215	1	1.31(a)	1
LX-11-0(c)	-307.3	1	1.23(d)	1
Octol	+26	1	—	—
PB9404(e)	+0.8	1	1.38(a)	1
Pentolite 50/50	-239	2	1.23(d)	1
XTX-8003(f)	-444	1	1.16(d)	1

- (a) Moderate confinement
 (b) 85/15 HMX/Viton
 (c) 80/20 HMX/Viton
 (d) Heavy confinement
 (e) 94/3/3 HMX/NC/binder
 (f) 80/20 PETN/Silicone rubber

Refs: 1) UCRL-51319 "Props of Chem Expls and Expl Simulants," Dec 1972 2) Algebraic addn of ΔH_f° 's of individual explosive compositions taken from Table 1

Table 3
Melting Points, Heats of Fusion, Heats of Vaporization and Heats of Sublimation of Common HE

Explosive	mp(a) °C	ΔH_{fus} (a) kcal/mole	ΔH_{vap} (a) kcal/mole	ΔH_{subl} (a) kcal/mole
DATB	290(12)	—	—	33.5(10)
β HMX	286(16)	—	—	41.9(10)
HNS	318(15)	—	—	43.0(10)
NG	12.8(4)	6.0(5)	<u>20.0</u> (8) 18.5(1) 26(5)	— — —
Nitroform	15	3.6(9)	7.8(9)	11.1(9)
NMethane	-29	—	<u>9.2</u> (11) 8.4(8)	—
PETN	141(12)	—	23.0(1) 17.8(6)	36.3(4)
Picric Acid	122(12)	4.7(12)	21.0(1)	—
RDX	205.5(13)	8.5(13)	26.0(1)	<u>31.1</u> (10) 26.8(4)
TATB	330(12)	—	—	40.2(10)
Tetryl	126.5(13)	6.2(13) 6.4(12)	26.0(1)	—
TNA(b)	188	—	—	27.7(10)
TNB(c)	121	4.0(14)	<u>17.5</u> (7) 18.5(1)	— —
TNT	81(12)	5.4(2) 5.1(12)	17(1) <u>18.4</u> (8)	28.3(2) <u>24.4</u> (3)

(a) Numbers in () are Refs; underlined values are preferred

(b) 2, 4, 6-Trinitroaniline

(c) Sym-Trinitrobenzene

Refs: 1) A.F. Belyaev, ZhFizKh **22**, 91 (1948) 2) G. Edwards, TransFaradSoc **46**, 423 (1950) & **CA 44**, 9754 (1950) 3) I. Nitta et al, NipponKagakuZasshi **71**, 378 (1950) & **CA 45**, 6448 (1951) 4) G. Edwards, TransFaradSoc **49**, 152 (1953) 5) M.D. Kemp et al, JPhysChem **61**, 240 (1957) & **CA 51**, 8524 (1957) 6) N. Lundborg, Arkiv Fysik **20**, 499 (1961) & **CA 56**, 7567 (1962) 7) Yu. Ya. Maksimov "Teoriya V V Sb Statei" (1963) & **CA 59**, 12206 (1963) 8) J. Roth, Final Rept SRI Contract NOW 65-0283-d "Evaluation of the Wenograd Test" p 36 (1966) 9) E.A. Miroshnichenko et al, Zh Fiz Khim **41**, (6), 1477 (1967) & **CA 67**, 85584 (1967) 10) J.M. Rosen & C. Dickinson, J Chem Eng DATA **14**, 120 (1969) & **CA 11** D.R. Stull, E.F. Westrum & G.C. Sinke "The Chemical Thermodynamics of Organic Compounds", Wiley & Sons (1969) 12) AMCP 706-177 (1971) 13) P.G. Hall, Trans Farad Soc **67**, 556 (1971) & **CA 74**, 103825 (1971) 14) N.D. Lebedeva et al, Zh Fiz Khim **45**, 980 (1971) & **CA 75**, 11145 (1971) 15) Brochure Del Mar Co of Los Angeles, Calif, date unknown 16) UCRL-51319 "Props of Chem Expls and Expl Simulants", Dec 1972

Table 4
Heat Conductivity Coefficients and Specific Heats of Common Explosives

Explosive	Coeff of Heat Conduction (cgs) x 10 ⁴	Specific Heat	
		temp (°C)	c _p (cal/deg g)
Baratol	11.8 at 2.5 g/cc (3)	-75	0.280 (6)
		0	0.213 (6)
		25	0.201 (6)
		100	0.171 (6)
Comp B	6.3 at 1.71 g/cc (6)	-75	0.235 (6)
		0	0.220 (6)
		25	0.254 (6)
		50	0.305 (6)
		75	0.376 (6)
		85	0.354 (6)
		100	0.312 (6)
DNT	6.2 at 1.32 g/cc (5)	18-40	0.324 (7)
		—	—
HMX		-75	0.153 (6)
		0	0.228 (6)
		25	0.248 (6)
		50	0.266 (6)
		100	0.295 (6)
		150	0.315 (6)
β HMX		-70 to 250°C	0.0935 + 5x10 ⁻⁴ T (5)
Lead Azide	1.6 (5) 4 at 3.62 g/cc (2)	-50 to 50	0.110 (6)
		100	0.100 (2)
		200	0.117 (2)
		250	0.116 (2)
Lead Styphnate		-50	0.141 (6)
		0	0.158 (6)
		25	0.164 (6)
		50	0.167 (6)
		100	0.164 (2)
		200	0.191 (2)
Mercury Fulminate	1 (5) 2.9 (1)	110 to 125	0.120 (2)
NMethane		liq	0.414 (4)
NG		solid	0.315 (6)
		liq	0.356 (6)
LX-04	9.3 at 1.86 g/cc (6)	20	≈0.28 (7)
PBX9404	10.1 at 1.83 g/cc (6)	-55	0.18 (3)
		-10	0.26 (3)
		22	0.24 (3)
		55	0.25 (3)
		85	0.28 (3)
PETN	6 at 1.46 g/cc (2)	115	0.272 (1)

Table 4 (Continued)
Heat Conductivity Coefficients and Specific Heats of Common Explosives

Explosive	Coeff of Heat Conduction	temp (°C)	Specific Heat
	κ (cgs) $\times 10^4$		c_p (cal/deg g)
Picric Acid (PA)	6.2 at 1.41 g/cc (5)	0	0.235 (6)
	2.4 at 1.7 (1)	30	0.258 (6)
		60	0.282 (6)
		120	0.337 (6)
		?	0.26 (1)
RDX	6.9 at 1.26 g/cc (5)	20	0.298 (6)
	7.0 at 1.53 g/cc (5)	60	0.330 (6)
		100	0.406 (6)
		140	0.446 (6)
Tetryl	5.8 at 1.39 g/cc (5)	-100	0.182 (6)
	6.8 at 1.53 g/cc (5)	-50	0.200 (6)
	2.3 at ? (1)	0	0.212 (6)
		50	0.223 (6)
		100	0.236 (6)
	?	0.225 (1)	
TNT	5.3 at 1.19 g/cc (5)	0	0.309 (6)
	7.1 at 1.51 g/cc (5)	20	0.328 (6)
	6.2 at 1.6 g/cc (6)	50	0.353 (6)
		80	0.374 (6)
	4.8 at 1.6 $\frac{g}{cc}$ (5)	93 liq	0.376 (4)
	3.5 at 0.8 $\frac{g}{cc}$ (1)	? liq	0.35 (1)

Refs: 1) A.F. Belyaev & N. Matyushko, Compt Rend URSS **30**, 629 (1941) & CA **37**, 531 (1943)
 2) Quoted in Bowden & Yoffee (1958), pp 153 & 155 3) LRL, Gen Chem Tech Note Number 128, "Props of Chem Expls", June 1963 4) W.C. Davis, preprints Proc 4th Symp on Deton p A-41 (1965) 5) H.H. Licht, Sympos on Chemical Problems connected with the Stability of Explosives, Tyninge, Sweden, 1970, p 177 6) AMCP **706-177**, (1971) 7) B.M. Dobratz, UCRL-**51319**, "Props of Chem Expls and Expl Simulants," Dec 1972

κ cal/cm/sec/°c $\times 10^{-4}$

Heat Effects – Methods for Estimating ΔH_f° .

In the preceding sections we have emphasized the importance of knowing the heats of formation of explosive materials in order to estimate ΔH_d , detonation product compositions, fire & explosion hazards of potentially dangerous materials, and critical diameters for thermal explosions. This is by no means a complete list of the uses of heats of formation. Thus the ΔH_f° of a compound is indeed one of its most useful properties. However, how does one proceed if the ΔH_f° for a material of interest has not been determined experimentally? The obvious answer to this is by estimating ΔH_f° on the basis of theoretical or semi-empirical methods. Many such methods exist. The following article contributed by Dr. Robert Shaw of SRI presents a method that is particularly applicable to estimating the heats of formation of explosive compounds

Estimation of Heats of Formation of Organic Chemical Explosives by Group Additivity.

Introduction. During the past decade there have been significant developments of empirical methods for estimating the thermodynamic properties of organic compounds based on group additivity methods

Advances in scientific and technological aspects of chemistry are dependent on advances in basic information. Thermochemistry is important in our understanding of molecular structure including stabilities, strain energies, and interaction with radiation. It is also

important in predicting reaction equilibria and yields, in process design, in thermal engineering applications, and in evaluating fire and explosion hazards. So far, the ideal gas state has received a large portion of thermochemists' efforts. For example, the first page of the filing order for JANAF Thermochemical Data (Ref 6) contains 58 gases, 10 liquids, and 28 solids. This emphasis on gas phase stems partly from its more advanced theoretical status and partly from its importance in military problems. However, in the incoming requests for data at Stanford Research Institute from chemical engineers, we have had many more inquiries for condensed phases than for gases

Estimated data have many advantages.

Measurements are time-consuming and costly, and in many cases estimates are all that are needed for screening purposes. On the other hand, a minimum of good experimental data is required as a basis for estimates. Estimates are especially important in explosives thermochemistry, because so many of the experimental measurements are buried in difficult-to-reach technical reports and in the classified literature

An important use of accurate estimates, such as those provided by Group Additivity, is that they provide a check on experimental measurements. In all cases where discrepancies have existed between measured data and those estimated by Group Additivity, repeating or checking the reported experimental data revealed errors. Some examples are given in Table 1

Table 1
Some Examples of the Use of Group Additivity to Check Experimentally
Determined Heats of Formation
(Units are kcal/mole for the ideal gas state.)

Compound	Original Measurement	Estimated by Group Additivity	Δ (Meas - Est)	Revised Measurement	Δ (Meas. - Est.)
1-Methylcyclopentene	-1.5 ^a	-0.3 ^a	-1.2	-0.6 ^b	0.2
Tetralin	2.6 ^a	6.6 ^a	-4.0	7.3 ^b	0.7
t-Butyl hydroperoxide	-52.1 ^a	-57.1 ^a	5.0	-58.8 ^b	-1.7
Hexanitrostilbene	29.2 ^c	58.6 ^d	29.4	57.0 ^e	1.6

^aRef 14

^bRef 15

^cRef 8

^dRef 20

^eRef 9.

Estimating techniques point out where experimental data are lacking and where sufficient experimental data already exist. For example, Table II shows heats of formation that have been reported since the 1969 paper on Group Additivity was published (Ref 14). The agreement between experimental data and that predicted by Group Additivity is very gratifying, but it raises questions of cost/benefit regarding the selection of these compounds for experimental study

Having discussed the need for estimated data, we turn now to the question, "why Group Additivity?" The most cogent answer is, user acceptance. In the present state of the art, there is a bewildering variety of methods of estimation, most of which are complicated, time-consuming, and of limited usefulness. The Group Additivity method is simple, fast, and accurate, and is quickly gaining wide acceptance as the best and most general method for estimation of gas-phase data. For example, *ASTM Committee E-27 on the Hazard Potential of Chemicals* has adopted Group Additivity as the method of choice for estimating thermochemical data. CIBA-GEIGY Inc has recently sent its Director of Explosion Hazard Research to SRI for a year to study estimating techniques with Dr. Benson. E.S. Domalski of the National Bureau of Standards has used Group Additivity methods to estimate the thermochemical properties of the air pollutants PAN (peroxyacetylnitrate) and PBN (peroxybenzoylnitrate) (Ref 17). Dr. Benson has been invited by the new ACS journal, *Chemical Technology*, to write a paper entitled, "The Use of Empirical Methods for the Prediction of Thermochemical and Kinetic Rate Data and the Uses of Limitations of Such Data in Laboratory Practice and in Plant Design." *The Environmental Protection Agency* has recently sponsored a project at SRI to apply computer techniques to the estimation of thermochemical and kinetic data using Group Additivity. The *McDonnell-Douglas Laboratories*, sponsored by a contract with the *Ballistic Research Laboratory*, is developing a computer program to use Group Additivity for gases. Two papers at the 65th Annual Meeting of the American Institute of Chemical Engineers ("Thermophysical Properties of Pure Chemical Compounds," by P.L. Chueh and C.H. Deal,

and "Implementation of Combined Second Order Additivity and Group Equations Methods for the Estimation of Chemical Thermodynamic Data," by W.H. Seaton and E. Freedman) dealt with applications of Group Additivity

A powerful argument in favor of Group Additivity is that a start has already been made in the application of Group Additivity to condensed phases. In 1969, groups were derived (Ref 11) for the heat capacities of liquids at 298°K that improved the precision of estimation from ± 4 to better than ± 1.5 cal/(mole·K). Since then, groups have been derived for heats of formation of solid nitroaromatics (Ref 20) and for solid and liquid nitroalkanes (Ref 22) *Group Additivity*. The basic idea behind Group Additivity is that chemical thermodynamic properties of molecules consist of contributions from the individual groups that make up the molecule. Group Additivity is therefore an extension of the series atom additivity, bond additivity, . . . , and turns out to be an excellent compromise between simplicity and accuracy

A useful way to look at it is to consider an example of Group Additivity applied to the ΔH_f° of gases at 25°C. The n-hexane molecule is made up of two methyls bonded to carbon atoms, indicated by $2[\text{C}(\text{C})(\text{H})_3]$, and four methylenes bonded to two carbon atoms, indicated by $4[\text{C}(\text{C})_2(\text{H})_2]$. Similarly, n-octane is composed of $2[\text{C}(\text{C})(\text{H})_3] + 6[\text{C}(\text{C})_2(\text{H})_2]$; thus

$$\Delta H_f^\circ (\text{kcal/mole})$$

$$2[\text{C}(\text{C})(\text{H})_3] + 4[\text{C}(\text{C})_2(\text{H})_2] = -40.0$$

$$2[\text{C}(\text{C})(\text{H})_3] + 6[\text{C}(\text{C})_2(\text{H})_2] = -49.8$$

$$\text{and } [\text{C}(\text{C})_2(\text{H})_2] = -4.9 \text{ and } [\text{C}(\text{C})(\text{H})_3] = -10.2$$

The ΔH_f° of n-decane may then be estimated as $2[\text{C}(\text{C})(\text{H})_3] + 8[\text{C}(\text{C})_2(\text{H})_2] = -59.6$ (cf -59.7 observed). The other groups were obtained similarly. In practice, when there is a large amount of measured data, the groups are derived by computer, using a least squares regression program, giving $[\text{C}(\text{C})(\text{H})_3] = -10.1$ and $[\text{C}(\text{C})_2(\text{H})_2] = -5.0$ kcal/mole

Table II
 Comparison of Estimated Heats of Formation with Some Measured Since 1969^a
 (The units are kcal/mole for the ideal gas state.)

Compound	Measured Since 1969	Estimated Using Group Values	Δ (Meas.-Est.)
n-Pentane	-35.08	-35.10	0.02
2-Methylbutane	-36.73	-36.29	-0.44
2,2-Dimethylpropane	-40.14	-39.82	-0.32
n-Propylcyclohexane	-46.0	-45.3	-0.7
1-Methyl-1-ethylcyclohexane	-46.6	-45.8	-0.8
1-Methyl-cis-2-ethylcyclohexane	-45.7	-44.9	-0.8
1-Methyl-trans-2-ethyl- cyclohexane	-46.6	-46.5	-0.1
1-Methyl-cis-3-ethylcyclo- hexane	-48.2	-48.1	-0.1
1-Methyl-cis-4-ethylcyclo- hexane	-46.3	-46.5	0.2
1-Methyl-trans-4-ethyl- cyclohexane	-49.1	-49.1	0.0
n-Propylcyclopentane	-35.3	-34.6	-0.7
3-Methylcyclopentene	2.0	1.8	0.2
Acenaphthene	37.4	36.8	0.6
Acenaphthalone	61.6	60.8	0.8
Cyclopropylamine	18.4	17.3	1.1
2-Methyl-1-butane thiol	-27.42	-27.24	-0.18
3-Methyl-1-butane thiol	-27.40	-27.24	-0.16
3-Methyl-2-butane thiol	-28.91	-29.36	0.45
2,2-Dimethyl-1-propane thiol	-30.76	-30.77	0.01
2,3-Dimethyl-2-butane thiol	-35.22	-36.55	1.33
2-Methyl-2-pentane thiol	-35.37	-35.17	-0.20
α -Toluene thiol	21.90	21.90	0.00
Diethyl ketone	-61.7	-62.0	0.3
Methyl-n-propyl ketone	-61.9	-61.7	-0.2
Methyl-isopropyl ketone	-62.8	-63.3	0.5
Methyl-n-butyl ketone	-66.9	-66.7	-0.2
Methyl-t-butyl ketone	-69.5	-70.3	0.8
Ethyl-n-propyl ketone	-66.5	-66.9	0.4

Table II (Continued)
 Comparison of Estimated Heats of Formation with Some Measured Since 1969^a
 (The units are kcal/mole for the ideal gas state.)

Compound	Measured Since 1969	Estimated Using Group Values	Δ (Meas.-Est.)
Ethyl-isopropyl ketone	-68.4	-68.5	0.1
Ethyl-t-butyl ketone	-75.0	-75.5	0.5
Diisopropyl ketone	-74.4	-75.1	0.7
Isopropyl-t-butyl ketone	-80.8	-82.1	1.3
Di-n-butyl ketone	-82.4	-81.8	-0.6
Di-t-butyl ketone	-82.6	-89.1	6.5
Methyl-hexyl ketone	-82.5	-76.6	-5.9
Ethyl-pentyl ketone	-80.9	-76.8	-4.1
Propylbutyl ketone	-83.5	-76.8	-6.7
Di-isobutyl ketone	-85.5	-84.3	-1.2
t-Butyl-neopentyl ketone	-94.2	-94.0	-0.2
Di-n-pentyl ketone	-92.6	-91.7	-0.9
Acrolein	-17.8	-17.8	0.0
But-2-enal	-25.5	-25.6	0.1
Benzaldehyde	-8.9	-8.9	0.0
3,5-Dioxahепtane	-99.1	-98.8	-0.3
1,1-Diethoxyethane	-108.4	-109.2	0.8
3,6-Dioxaoctane	-97.6	-99.0	1.4
2,4,6-Trimethyl-3,5-dioxahепtane	-125.7	-126.4	0.7
6-Ethyl-5,7-dioxaundecane	-132.1	-133.9	1.8
3,5,7-Trioxanonane	-138.9	-138.2	-0.7
3,5,7,9-Tetraoxaundecane	-177.1	-177.5	0.4
3,5,7,9,11-Pentaoxatridecane	-216.5	-216.8	0.3
Propionaldehyde	-44.5	-44.4	-0.1
Dimethoxyethane	-83.2	-82.7	-0.5
1,1-Dimethoxyethane	-93.1	-92.9	-0.2

^a The hydrocarbon and amine data are from Ref 19, the sulfur data are from Ref 25, and the data for oxygenated compounds are from Ref 21

For a second example, from Stull, Westrum, and Sinke, (Ref 12) for n-pentane $\Delta H_f(\text{liquid}) = -41.4$ kcal/mole, and for n-hexane, $\Delta H_f(\text{liquid}) = -47.5$ kcal/mole. n-Hexane has one more $[\text{C}(\text{C})_2(\text{H})_2]_l$ group than n-pentane, therefore, $[\text{C}(\text{C})_2(\text{H})_2]_l = -47.5 - (-41.4) = -6.1$ (where the subscript l denotes liquid phase). Substituting the above value of -6.1 we obtain the methyl group $[\text{C}(\text{C})(\text{H})_3]_l = [-47.5 - 4(-6.1)]/2 = [-47.5 + 24.4]/2 = -23.1/2 = -11.6$
 Check: $\Delta H_f(\text{n-heptane})_l = 2[\text{C}(\text{C})(\text{H})_3]_l + 5[\text{C}(\text{C})_2(\text{H})_2]_l = 2(-11.6) + 5(-6.1) = -23.2 - 30.5 = -53.7$ kcal/mole, cf -53.6 measured (Ref 12). As an added bonus, we obtain groups for estimating heats of vaporization. From previous work (Ref 14) we know that for the ideal gas the value for the group $[\text{C}(\text{C})(\text{H})_3]_g$ is -10.1 kcal/mole (where the subscript g denotes ideal gas). Therefore, $[\text{C}(\text{C})(\text{H})_3]_{\text{vap}} = [\text{C}(\text{C})(\text{H})_3]_g - [\text{C}(\text{C})(\text{H})_3]_l = -10.1 - (-11.6) = 1.5$ kcal/mole (where the subscript vap denotes heat of vaporization). Similarly, $[\text{C}(\text{C})_2(\text{H})_2]_{\text{vap}} = [\text{C}(\text{C})_2(\text{H})_2]_g - [\text{C}(\text{C})_2(\text{H})_2]_l = -5.0 - (-6.1) = 1.1$ kcal/mole. Then the heat of vaporization of n-heptane at 298 K $= 2[\text{C}(\text{C})(\text{H})_3]_{\text{vap}} + 5[\text{C}(\text{C})_2(\text{H})_2]_{\text{vap}} = 2(1.5) + 5(1.1) = 3.0 + 5.5 = 8.5$ kcal/mole cf, 8.7 measured (Ref 12)

To date, group values have been derived for heats of formation of the states and classes of compounds shown in Table III.

Table III
Group Values Now Available

State	Class of Compound	Reference
Ideal gas	Organics in general	14
Solids	Nitroaromatics	20
Solids, liquids, ideal gases	Nitroalkanes	22
Ideal gas	Oxygen-containing organics	21
Ideal gas	Azo. compounds	26

Heats of Formation of Solid Nitroaromatics. In principle, there are two methods of using group additivity to determine heats of formation of solids. If the groups are available, then the heat of formation of the ideal gas can be calculated.

If the heat of sublimation is known, then the heat of formation of the solid follows. The second method is to develop group values for solids and to use these directly to calculate the required heat of formation. The heats of formation of some solid nitroaromatic compounds present an interesting example of the two approaches. The results suggest that the direct approach of using group values for solids is the better method at present

The Ideal Gas Method. The heat of formation of a nitroaromatic compound in the ideal gas state requires that the $\text{C}_B\text{-NO}_2$ group be known (where C_B represents an aromatic, i.e., benzene carbon atom). This group was not given in the recent ideal gas group additivity review (Ref 14). The group may be obtained from the heat of formation of any nitroaromatic compound in the ideal gas state if the other groups are known. For example, for nitrobenzene $\Delta H_f^\circ = 5(\text{C}_B\text{-H}) + 1(\text{C}_B\text{-NO}_2) = 16.9$ kcal/mole (Table IV). From the known value of $(\text{C}_B\text{-H}) = 3.3$ kcal/mole, $(\text{C}_B\text{-NO}_2) = 16.9 - 16.5 = 0.4$ kcal/mole. In Table IV the heats of formation of several nitroaromatic compounds in the ideal gas state are calculated from the measured heats of formation of the solid and the measured heats of sublimation. In cases where the heat of sublimation is not measured at 298°K there should be a correction for the differences in heat capacities of the solid and ideal gas. The data required to make these corrections are not available but in general it is expected that the corrections will be small and can be neglected. From the heats of formation of each compound in the ideal gas state, a value for the group $\text{C}_B\text{-NO}_2$ (ideal gas) has been derived (Table IV). A weighted-average value $(\text{C}_B\text{-NO}_2(\text{ideal gas})) = 3.0$ kcal/mole was used, and a heat of formation was estimated for each compound. In Table IV the difference between observed and estimated heat of formation in the ideal gas state is less than ± 3.2 kcal/mole in all cases

Table IV
Measured and Estimated Heats of Formation of Various Compounds at 298°K in kcal/mole

	ΔH_f	Ref	ΔH_f	Ref	ΔH	Ref	ΔH	Ref	ΔH_f	C ₈ -NO ₂ group	ΔH_f	Δ	ΔH_f	Δ
	Crystal		Liquid		Sublimation		Vaporization		Ideal Gas					
Nitrobenzene			3.8	25			13.1	8	16.9	0.4	19.5	-2.6		
2,2',4,4',6,6'-Hexanitrostilbene (HNS)	13.9	9			43.0 at 457°K	17			56.9	2.7	58.5	-1.7		
trans-Stilbene (TS)	32.7	9			20.7	18			53.4					
2,4,6-Trinitrotoluene (TNT)	-15.4	9			28.3 24.4	7 19			12.9 9.0	3.2 1.9	12.2 12.2	0.7 -3.2	-15.0	-0.4
2,4,6-Trinitroaniline (TNA)	-17.8	12			27.7 at 350°K	17			9.9		12.9	-3.0	-18.0	+0.2
1,3-Dinitro-2,4,6-trinitrobenzene (DATB)	-29.2	16			33.5 at 358°K	17			4.3		6.9	-2.6	-27.0	-2.2
1,3,5-Trinitro-2,4,6-trinitrobenzene (TATB)	-36.9	16			40.2 at 426°K	17			3.3		0.9	2.4	-36.0	-0.9
m-Dinitrobenzene (m-DNB)	-6.2	12											-6.0	-0.2
1,3,5-Trinitrobenzene (TNB)	-9.6	17											-9.0	0.6
p-Nitroaniline (p-NA)	-10.0	12											-12.0	+2.0
2,4-Dinitroaniline (DNA)	-15.7	12											-15.0	0.7
2,6-Dinitrotoluene (DNT)	-10.5	12											-12.0	+1.5
HNS minus TS	-18.8								3.5	3.5	0.6	2.9	-18.0	-0.8

^aFrom the data given by Timmermans (Ref 7), $\Delta H_{vap} = 11.34$ kcal/mole at 450°K. For liquids like nitrobenzene¹¹, C_p (liquid) minus C_p (gas) = 12 cal/(mole deg), so ΔH_{vap} at 298°K = 11.3 + 12(450-298) = 13.1 kcal/mole

The Group Additivity for Solids Method. The large number of compounds for which the heat of formation of the solid has been measured makes the group additivity for solids an attractive method. From the measured data (Table IV), groups were derived by inspection. The values for the groups are $(C_B-H) = 0$, $(C_B-NO_2) = -3$, $(C_B-NH_2) = -9$, and $(C_B-CH_3) = -6$ kcal/mole. If the groups had been derived statistically, there would probably be a slight improvement, but the convenience of having $(C_B-H) = 0$ and integral values for the other groups would be lost in the process. Using these groups, the heats of formation in the solid state for a number of compounds have been calculated. The differences between observed and estimated values are small and in the range expected for group additivity.

Conclusion. In general, the fit between observed and estimated values suggests that the principle of group additivity can be successfully applied to the heats of formation of solids. At present this approach is more convenient than using ideal gas groups together with heats of sublimation

Heats of Formation of Nitroalkanes. The heats of formation of several liquid and solid polynitroalkanes have recently been measured by Lebedeva and Ryadnenko (Ref 10). Their results support and extend some earlier work by Holcomb and Dorsey (Ref 2) and by Médard and Thomas (Ref 5). Data for the liquid and gaseous mononitroalkanes have been evaluated by Stull, Westrum, and Sinke (Ref 12). JANAF (Ref 6) have reported some unpublished results by Shomate. All the above results are listed in Table V with estimates based on group additivity using the group values derived by us and listed in Table VI. The agreement between observed and estimated values is very good with a few exceptions. The most spectacular exception is 1,1,1,3,5,5-Heptanitropentane where, even allowing for 6 alkyl gauche interactions, the compound is made unstable by about 14 kcal/mole, perhaps because of NO_2 crowding

Another anomaly is found for the 1,1,1-fluorodinitroalkanes. The experimental ΔH_f for 1,1,1-DNE and 1,1,1-DNP both give values for the group $C-(C)(NO_2)_2(F)$ which differ by 9 kcal/mole. For lack of definite information, the difference is split equally in setting the group value. However, the following comparison suggests that the experimental ΔH_f for 1,1,1-DNE is suspect:

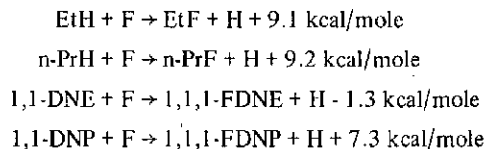

More work is needed on the experimental values of ΔH_f for the 1,1,1-fluorodinitroalkanes

Table V
Heats of Formation of Nitroalkanes

	SOLID				LIQUID				IDEAL GAS				
	gauche corrections	obs	ref	est	diff (obs-est)	obs	ref	est	diff (obs-est)	obs	ref	est	diff (obs-est)
1-NITROALKANES													
Nitroethane						-33.9	12	-33.1	-0.8	-24.2	12	-24.5	0.3
1-Nitropropane						-40.2	12	-39.2	-1.0	-29.8	12	-29.5	-0.3
1-Nitrobutane						-46.0	12	-45.3	-0.7	-34.4	12	-34.5	0.1
2-NITROALKANES													
2-Nitropropane							12				12		
2-Nitrobutane	1-alk-NO ₂					-43.3	12	-44.4	1.1	-33.5	12	-33.8	0.3
						-49.6	12	-48.5	1.1	-39.1	12	-38.8	-0.3
1,1-DINITROALKANES													
1,1-Dinitroethane						-35.4	10	-35.6	0.2			-20.0	
1,1-Dinitropropane	1-alk-NO ₂					-39.9	10	-39.7	-0.2	25.0		-25.0	[0] ^b
1,1-Dinitropentane	1-alk-NO ₂					-51.9	10	-51.9	0.0			-35.0	
1,1,1-FLUORODINITROALKANES													
1,1,1-Fluorodinitroethane						-67.3	6	-71.8	4.5	-57.0	24	-57.0	[0]
1,1,1-Fluorodinitropropane	1-alk-NO ₂					-80.4	6	-75.9	4.5			-62.0	
ALPHA-OMEGA DINITROALKANES													
1,2-Dinitroethane		-42.7	10	-44.4	1.7	-39.7	10	-43.0	3.3			-28.8	
1,3-Dinitropropane				-51.3		-49.5	10	-49.1	-0.4			-33.8	
1,4-Dinitrobutane		-59.6	10	-58.1	1.5	-56.8	10	-55.2	-1.6			-38.8	
PRIMARY-SECONDARY DINITROALKANES													
1,2-Dinitropropane	1-alk-NO ₂							-52.3				-38.1	
2,2-DINITROALKANES													
2,2-Dinitropropane		-46.0	10	-47.5	1.5	-43.3	10	-44.2	1.1	-30.4	2	-30.4	[0]
2,2,3,3-Tetranitrobutane	4-alk-NO ₂ 2 NO ₂ -NO ₂	-43.6	10	-42.7	-0.9	-40.1	10	-39.2	-0.9				
1,1,1-TRINITROALKANES													
1,1,1-Trinitroethane		-26.9	10	-26.8	-0.1	-23.2	10	-24.6	1.4				
Hexanitroethane	6 NO ₂ -NO ₂	28.6	6	26.8	1.8								
1,1,1-Trinitropropane	2-alk-NO ₂					-28.1	6	-26.7	-1.4				
1,1,1,3-Tetranitropropane	2-alk-NO ₂	-38.6	6	-38.7	0.1								
1,1,1,4-Tetranitrobutane	2-alk-NO ₂	-45.4	10	-45.5	0.1	-42.8	10	-42.7	-0.1				
1,1,1,3,5,5-heptanitropentane	6-alk-NO ₂	-36.7	10	-49.9	13.2	-33.7	10	-47.4	13.7				
TERTIARY NITROALKANES													
2,3-Dimethyl-2,3-dinitrobutane	6-alk-NO ₂	-74.5	10	-74.5	[0.0]	-71.0	10	-71.0	[0]				
NITROALKENES													
Nitroethylene												13.4	
1-Nitropropylene												5.6	
2-Nitropropylene												0.6	

^aCalculated from data in reference 2

^bSquare brackets indicate that the compound was the sole source of this group, so that there is necessarily a fit between observed and estimated data

Table VI
Group Values for Estimating Heats of
Formation of Nitroalkanes

Group	Solid	Liquid	Ideal Gas
C-(C)(H) ₂ (NO ₂)	-22.2	-21.5	-14.4
C-(C) ₂ (H)(NO ₂)	(-21) ^a	-21.2	-13.6
C-(C) ₃ (NO ₂)	-17	-18.3	
C-(C)(H)(NO ₂) ₂		-24.0	-9.9
C-(C)(F)(NO ₂) ₂		-60.2	-46.9
C-(C) ₂ (NO ₂) ₂	-21.2	-21.0	-10.2
C-(C)(NO ₂) ₃	-13.6	-13.0	
alk-NO ₂ gauche	2	2	0
NO ₂ -NO ₂ gauche	9	9	
C-(C)(H) ₃	-13.5 ^b	-11.6 ^c	-10.1 ^d
C-(C) ₂ (H) ₂	-6.85 ^b	-6.1 ^c	-5.0 ^d
C _d -(H)(NO ₂) ^a			7.1 ^e
C _d -(C)(NO ₂) ^a			4.4 ^e

^aBased on liquid phase group

^bBased on nC₁₈H₃₈ and nC₃₂H₆₆ (Ref 12)

^cBased on nC₅H₁₂ and nC₆H₁₄ (Ref 12)

^dRef 14

^eEstimated from kinetics (Ref 22)

Table VII
 Heats of Formation (in kcal/mole) of Azo Compounds Measured by
 Engel and Wood (Ref 23) and Estimated by Group Additivity

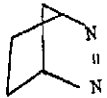
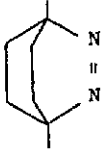
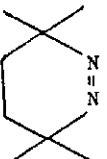
Compound	ΔH_f liquid	ΔH_{vap}	ΔH_f^0 gas		Difference
			obs	est	
$[\text{CH}_3\text{CH}_2\text{CH}_2\text{N}]_2$ trans	4.0	8.0	12.0	12.0	[0]
$[(\text{CH}_3)_2\text{CHN}]_2$ trans	0.4	8.0	8.4	8.4	[0]
cis	0.4	10.0	10.4	9.4	1.0
$[(\text{CH}_3)_3\text{CN}]_2$ trans	-18.4	8.8	-9.6	-9.6	[0]
	35.5	11	46.5	48.6	-2.1
	5.6	13	18.6	21.7	-3.1
	1.1	9.7	10.8	6.0	2.8

A small but mathematically significant deviation from group additivity is shown by 1,2-dinitroethane in the liquid phase. The difference of 3.3 kcal/mole between the observed and estimated values is too large and cannot reasonably be reduced by altering the group value. An experimental value of the heat of vaporization of 1,2-dinitroethane is needed *Azo Compounds in Ideal Gas State*. As Benson and Walsh have commented (Ref 14), "(Thermochemical) information on azo compounds is particularly lacking." The only azo compounds for which experimentally determined heats of formation have been published are difluorodiazine FNNF, diimide HNNH, and azoisopropane $(\text{CH}_3)_2\text{CHNNCH}(\text{CH}_3)_2$. However, Engel and Wood (Ref 23) recently measured the heats of combustion and vaporization of a large group of azo compounds. Their results are summarized in Table VII

Engel and Wood's value for the heat of formation of azoisopropane is 11 kcal/mole less stable than Coates and Sutton's 1948 value (Ref 1) of 19.4 kcal/mole. A consequence of this change is that ΔH_f° of azomethane calculated from graph values (Table VIII) becomes 34.0 kcal/mole instead of the previous value (Ref 6) of 44.7 kcal/mole. A further consequence is that the heat of hydrogenation of azomethane then becomes 12.4 kcal/mole, which is very different from the heat of hydrogenation of diimide (27.4 kcal/mole). However, Engel and Wood's data are very self-consistent as shown by the reasonable agreement between their experimental results and those calculated by group additivity for the cyclic compounds (Table VIII). Therefore the more recent work by Engel and Wood is favored

Table VIII.
Group Values for Calculating Heats
of Formation of Trans Azoalkanes
and Azo Radicals^a

Group	ΔH_f° (kcal/mole)
$\text{N}_A\text{-(N}_A\text{)}(\text{C})$	56.4
$\text{N}_A\text{-(C)}$	27.0
$\text{C-(N}_A\text{)}(\text{H})_3$	-10.1
$\text{C-(N}_A\text{)}(\text{C})(\text{H})_2$	-6.0
$\text{C-(N}_A\text{)}(\text{C})_2(\text{H})$	-3.4
$\text{C-(N}_A\text{)}(\text{C})_3$	-3.0

^aThis table was compiled from data in references 23 and 18 and after considerable discussion with S.W. Benson. There are some typographical errors on p 32 of O'Neal and Benson's monograph (Ref 15). The groups $[\text{C-(N)}(\text{H})_2]$, $[\text{C-(N)}(\text{H})(\text{C})]$, and $[\text{C-(N)}(\text{C})_2]$ in the third column of Table V-8 are all missing a carbon atom. They should read $[\text{C-(C)}(\text{N})(\text{H})_2]$, $[\text{C-(N)}(\text{H})(\text{C})_2]$, and $[\text{C-(N)}(\text{C})_3]$. Also in the text $\text{DH}_1^\circ - \text{DH}_2^\circ$ should read $\text{DH}_1^\circ + \text{DH}_2^\circ$.

Conclusions. Group additivity, an established technique for estimating the heats of formation, has been well developed for application to organic chemicals, in general, in the ideal gas state. However, very little has been done in deriving the group values for the many classes of organic explosives in condensed phases, especially the solid state. The principles are there; it is only a case of doing the work

Written by R. SHAW

Refs: 1) G.E. Coates & L.E. Sutton, *J Chem-Soc* **1948**, 1187 & *CA* **43**, 931 (1949) 2) D.E. Holcomb & C.L. Dorsey, Jr, *Ind Eng Chem* **41**, 2788 (1949) & *CA* **44**, 2812 (1950) 3) I. Nitta et al, *Nippon Kagaku Zasshi*, **71**, 378 (1950) & *CA* **45**, 6448 (1951). 4) J.J. Englesman, Ph D Thesis, Vrije Univ, Amsterdam, 1955 5) L. Médard & M. Thomas, *MP* **36**, 97 (1954) & *CA* **50**, 3763 (1956) 6) JANAF Thermochemical Tables, Dow Chemical Co, Midland, Mich, 1960 7) J. Timmermans, "Physico-Chemical Constants for Pure Organic Compounds" Vol I & II, Elsevier, NY, 1960 & 1965 8) S. Marantz & G. Armstrong, *J-Chem Eng Data*, **13**, 118 (1968) & *CA* **68**, 77594 (1968) 9) S. Marantz & G.T. Armstrong, *J Chem Eng Data*, **13**, 455 (1968) 10) N.D. Lebedeva & V.L. Ryadnenko, *Russ J Phys-Chem*, **42** (9), 1225 (1968) & *CA* **69**, 110602 (1968) 11) R. Shaw, *J Chem Eng Data* **14**, 461, (1969) & *CA* **71**, 129476 (1969) 12) D.R. Stull et al, "The Chemical Thermodynamics of Organic Compounds", John Wiley & Sons, NY, 1969 13) J.M. Rosen & C. Dickenson, *J Chem Eng Data*, **14**, 120 (1969) & *CA* **70**, 94800 (1969) 14) S.W. Benson et al, *Chem Rev* **69**, 279 (1969) & *CA* **71**, 33973 (1969) 15) J.D. Cox & G. Pilcher, "Thermodynamics of Organic and Organometallic Compounds" Academic Press, NY, 1970 16) C.H. Shomate, NOTS, China Lake, Calif, private communication, 1970 17) E.S. Domalski, *Nat-Bur Stds*, Wash, DC, private communication, 1970 18) S.W. Benson & H.E. O'Neal, "Kinetic Data on Gas-Phase Unimolecular Reactions", NSRDS-NBS 21, Gov Printing Office, Wash, DC, 1970 19) W.D. Good & R.T. Moore, *J Chem Thermodynamics*, **3**, 701 (1971) & **4**, 709 (1972) & *CA* **76**, 18689 (1972) 20) R. Shaw, *J Phys Chem* **75**, 4047 (1971) & *CA* **76**, 18701 (1972) 21) H.K. Eigenmann et al, *J Phys Chem* **77**, 1687 (1973) 22) R. Shaw, *Int J Chem Kinetics* **5**, 261 (1973) 23) P.S. Engel & J.L. Wood, unpublished work, 1973 24) R.W. Woolfolk, unpublished work 25) R. Shaw, *Thermochemistry of Thiols, "Chemistry of the Thiol Group"*, S. Patai, ed, John Wiley, NY, 1973 26) R. Shaw, *Thermochemistry of Azo Compounds, "Chemistry of Hydrazo, Azo, and Azoxy Groups"*, S. Patai, ed, John Wiley, NY, 1974

Heat of Evaporation. See under Heat, Latent

Heat Evolution (or Liberation) in Explosives.

For a detonation to be self-sustaining the detonating explosive must liberate a considerable amount of heat. If energy is lost to the surroundings the detonation characteristics are altered, and if sufficient energy is lost the detonation fails. For a steady detonation, the energy evolved in the detonation reactions must obviously be greater than the energy lost to the surroundings

[See Vol 4 of Encycl, under Detonation (and Explosion), Heat of]

Heat of Formation. See Vol 4 of Encycl under DETONATION (ANDEXPLOSION), DEFLAGRATION (AND COMBUSTION), AND FORMATION, HEATS OF & Tables 1 & 2 this Vol

Heat of Fusion. See under Heat, Latent and Table 3 of this Vol

Heat of Hydration is the amount of heat absorbed or liberated when a substance combines with water

Heat, Latent ("Latent" means "lying hidden" or "not manifest"). It is the heat absorbed by a substance without causing a rise in temperature

There are two kinds of latent heat:

- a) *Latent heat of fusion* is the amount of heat necessary to transform (melt, fuse) a unit quantity of solid into a liquid at the same temperature and standard pressure. Tables usually express it in calories per gram
- b) *Latent heat of vaporization (or evaporation)* (L) is the quantity of heat required to convert a unit quantity of liquid to vapor at the same temperature. Tables usually express it in calories per gram. (L) can also be calculated, approximately, by the Trouton's rule: $L = CT/M$, where (C) is a constant equal to 21 for most liquids, (T) boiling point in absolute degrees and (M) molecular weight. Example: L for acetone = $21 \times (56 + 273)/58 = 120$ cal/g against 124 actually measured

Refs: 1) Marshall, **3** (1932), p 250 2) S. Glasstone, *Physical Chemistry*, Van Nostrand NY (1940), pp 449 & 453 3) R.R. Wenner, "Thermochemical Calculations", McGraw-Hill, NY (1943), pp 20-5

Heat, Molecular is the amount of heat required to raise the temperature of one mol of a substance, 1°C , ie, the specific heat of the substance multiplied by its molecular weight

Heat Pulse. (Also see Detonation, Flash-Across, Heat Pulse and Hypervelocity Phenomena in Vol 4, p D348-49). A concept advanced by M.A. Cook (Refs 1 & 2) to provide a theoretical mechanism for the shock initiation of explosives. Cook also used the heat pulse concept in his explanation of certain unusual luminosity effects observed primarily in the detonation of liquid explosives. Briefly stated, Cook believes that detonation is initiated when as a result of rising temperature, produced by reaction in the already shocked region of an explosive, a portion of the explosive becomes thermally "super-conductive" and a "heat-pulse" flashes thru it and catches up with the shock front. Studies conducted by Kendrew & Whitbread (Ref 3) tend to discount the necessity for postulating a "heat-pulse" in a theoretical explanation of shock initiation or the above unusual luminosity effects. More recent studies of shock initiation have also failed to produce any conclusive evidence of a "heat-pulse" (Ref 4)

Refs: 1) Cook (1958) pp 83-89 & 164-166
2) M.A. Cook et al, Proc Third Symposium on Deton (1960), pp 150-183 3) E.L. Kendrew and E.G. Whitbread, *Ibid*, pp 202-204 & pp 574-583 4) Several papers on shock initiation in the Fifth Symp on Deton (1970)

Heat Sensitization of Explosives and Memory Effect. See under Detonation, Heat Sensitization and Memory Effect in Vol 4, p D367-R

Heat of Solidification. See Heat of Fusion under Heat, Latent

Heat of Solution. Same as Heat of Dissolution

Heat of Sublimation is the number of calories required, in a constant temperature process, to convert a unit weight of solid directly into a vapor

Heat of Swelling is the heat evolved when a colloid (eg gelatin, NC) absorbs a liquid (such as H_2O , acetone etc)

Heat of Transition is the quantity of heat liberated or absorbed when a substance changes from one allotropic crystal form to another

Heat Tests. Under this term may be placed all the stability tests which involve heating an explosive, eg Abel Heat Test, Acidity Measurements (pH measurements), American Test at 65.5° or 80° , Bergmann-Junk Test, Brame's Test, Brunswig's Test, Chiaraviglio & Corbino Test, Conductivity Method (De Bruin & de Pauw), Continuous Test, Deflagration Test, Desmaroux Test, Dupré's Vacuum Test, Dutch Test, German 132° Test, Grottanelli's Test, Guttman Test, Haid, Becker & Dittmar Test, Hansen's Test, Hess Test, Hoitsema Test, Horn-Seifert Test, International 75° Test, Jensen's Test, Loss of Weight Test, Marqueyrol's Test, Meerscheidt-Hüllessem Test, Mittasch's Test, Obermüller's Test, Pavlik's Test, Methyl Violet Test, Silvered Vessel Test, Simon Thomas Test, Spica Test, Sy Test, Taliani Test, Taylor's Test, Tomanari's Test, Vacuum Stability Test, Vieille Test, Warmlagermethode 75° (German Storage Test), Will Test

These tests are described separately in alphabetical order

Heat Value is the number of calories obtained by the complete combustion of a unit weight of substance

Heat of Vaporization. See under Heat, Latent

Heath and Frost patented in 1877 the use of a water-retaining paste such as soap 5, starch 0.5, glue 0.5 & water 94% for tamping bore-holes, loaded with dynamite, in order to prevent the ignition of firedamp

Ref: Daniel (1902), 371

Hebler Powder or Wellite. Smokeless powder used in Switzerland before the introduction of NC smokeless powders. It contains KNO_3 62.3, NH_4NO_3 15.8, charcoal 11.5, sulfur 9.5, moisture 0.9%. Use of this powder was abandoned because it is too hygroscopic

Refs: 1) Daniel (1902), 371 2) Van Gelder & Schlatter (1927) 782

Hecla Powder. An American Dynamite containing 20 to 75% NG absorbed by wood pulp, sodium nitrate etc

Ref: Daniel (1902), 371

Hedgehog. A British antisubmarine device for projecting 24 spigot type projectiles equipped with contact fuzes. They contain approx 30 lbs of HE each

Refs: 1) B. Rowland & W. Boyd, US Navy Bureau of Ordnance in WWII, Bur of Ord, Dept of the Navy (1953) 136 2) P. Eleson, *Ordn* 47, 610 (1963)

HEI. Abbreviation for High Explosive Incendiary

Height of Burst of Ground Type Pyrotechnic Signals, Determination. See under Position Finders

HEIT. Abbreviation for High Explosive Incendiary Tracer

Heliophanite. See under Panclastites

Hellhoff Explosive. According to GerP12122 of 1880, it was prepared by the nitration of purified tar oil, followed by washing, drying and mixing of the nitrotar with oxygen carriers, such as K (or Na) nitrate (or chlorate), etc. It was claimed that this explosive mixture was very powerful

Ref: See under Hellhoffit

Hellhoffit (Hellhoffite). One of the Sprengel type explosives, invented about 1870 by Hellhoff and Grüson. It consisted of 28 parts of nitrobenzene and 72 parts of fuming nitric acid. This liquid was sometimes used absorbed on kieselguhr (See Guhrhellhoffit). The disadvantage of these Sprengel type explosives was their extreme corrosiveness (Ref 1)

According to Thorpe (Ref 2), Hellhoffit was tried in shells, the two ingredients being mixed during flight & exploded on impact (see also Anilithe under French explosives)

Stettbacher (Refs 3 and 4) investigated Hellhoffit and its modifications and found that the glass-lined depth charges (Tiefenbomben) containing Hellhoffit, were much more effective than those loaded with Picric Acid. The mixture consisting of fuming nitric acid (d 1.52) 64.51,

nitrobenzene 25.81 carbon disulfide 6.45 and aluminum bronze 3.23% was found to be one of the most effective. A mixture prepd by dissolving 66.7 parts of Dinitrobenzene in 100 parts of fuming nitric acid was also claimed to be effective

Refs: 1) Davis (1943), p 354 2) Thorpe's Dictionary, v 4 (1940), p 545 3) A. Stettbacher *SS* 38, 158 (1943) 4) A. Stettbacher, *Spreng- und Schiesstoffe*, Zürich (1948), p 71 5) *PATR* 2510, (1958), p Ger 87-R (See also Vol 6, under "Explosifs de Sprengel")

Hemellitene and Its Nitrated Compounds. See under 1,2,3-Trimethylbenzene

Hemicelluloses (or Semicelluloses). A group of gummy substances intermediate in composition between cellulose and sugars. They are insoluble in hot water but readily soluble in dilute (4-5%) aqueous NaOH solutions. They are converted by warming with dilute acids (hydrolysis) at normal pressures into pentoses and hexoses (with galactose and glucose predominating), whereas cellulose itself yields only glucose (Ref 2)

According to Karrer (Ref 4) hemicelluloses comprise a series of complex polysaccharides, which like lichenin, occur as constituents of the cell walls, as well as reserve substances, occasionally becoming reconverted into sugar by the plant. On hydrolysis, many of them give galactose and mannose in addition to glucose; they are therefore known as galactans, mannans etc. Whether these substances are true compounds is very doubtful. Certain enzymes found in plants and in the intestinal tract convert them into sugars

Dorée (Ref 3) describes them as a polysaccharides, which in their natural state are insoluble in boiling water, but readily soluble in dilute caustic and easily hydrolysable on warming with dilute acids

Hemicellulose may be divided into **pentosans**-those yielding pentoses on hydrolysis, **hexosans**-those yielding hexoses and **xylans**-those yielding xyloses

The hemicelluloses give explosive compounds on nitration, but the yields are small and stabilization difficult (Ref 1)

Refs: 1) N. Solechnik, *J Applied Chem (USSR)* 6, 93-8 (1933) & *CA* 27, 5964 (1933) 2) Marsh & Wood, *Cellulose* (1945), 2 & 75 3) Dorée (1947) 31 4) Karrer (1950), 357

HEMP. A hydrodynamic code used for detonation product flow calculations. See Vol 4, p D152

Hemp Fiber (Chanvre in French). The bast-fiber obtained from the plant *Cannabis indica* or *C sativa*, which is a perennial herb (Ref 1). The plant is native of western and central Asia, but has long been cultivated in Brazil and tropical Africa, and is now extensively cultivated in many countries. Its fiber is used for preparation of ropes and paper, but was also proposed by Trench (Ref 2), in 1877 to be nitrated to an explosive

Refs: 1) Daniel (1902), 773 2) Webster's 7th New Collegiate Dict (1969), 388

Hemp Nitrate (Nitrohemp) (In French Nitrochanvre). Nitrohemp resembles cotton nitrocellulose or nitrojutite in its properties. It may be prepared by nitrating hemp with mixed nitric-sulfuric acid. Trench (Ref 2) proposed using it as a basic ingredient in commercial explosives. Other components were collodion cotton, resin, ozokerite, glycerin etc

Ref: Daniel (1902), 773

Hemp Hurds. The refuse from hemp (stems of *cannabis sativa*) fibers. A US patent claims their use as absorbents for liquid explosives such as NG

Ref: A.S. Fox & F. Rape, USP 1979681 (1934) & CA 29, 346 (1935)

Hengstit (Hengstite). A smokeless powder patented by Hengst in 1888 in Germany and France. It was prepd from nitrated "strawpulp" by treating it first with potassium permanganate and then with sodium carbonate. In order to render the mass cohesive and plastic it was mixed with glue prepd by boiling crushed flaxseed with dextrin. Finally to this were added KNO_3 , KClO_3 and ZnSO_4

When intended for use as a military propellant, the mass was either granulated or used in the form of fibers. When used as a mining explosive, it was a plastic pressed into boreholes

The same inventor proposed a propellant prepd by nitration of esparato grass (matweed) or of fibers covering coconut shells

Ref: Daniel (1902), 373

Henrite. Brit 33 grain NC rifle powder manufactured since 1900

Refs: 1) Daniel (1902) 373 2) Marshall 1, 326

HEO. Di(-hydroxyethyl) oxamide used in prepn of Dinitrodi(-nitroxyethyl) oxamide; see *Diethylloxamide* in Vol 5, p D1243-R

HEP. High Explosive, Plastic (HEP) is defined as ammunition designed to defeat armor by spalling or scabbing. Conventional HEP shells have thin walls, ogival noses, base fuzes, and large filler capacities

The expl chge is base detonated upon impinging on the target producing a high energy impulsive load. The incident shock wave is reflected from the rear surface of the target as a tension wave. When the stress exceeds the critical fracture stress of the target, part of the rear surface is "thrown off" as a spall

Development of HEP ammo based upon this principle was initiated in England during WWII after "wall buster" shells were found capable of scabbing armor. These shells were named HE/SH (High Explosive/Squash Head) since they "squash" against the target prior to deton of the filler

The US Army became interested in this method of defeating armor in 1947. Chamberlain Corp, Waterloo, Iowa prepd in 1960 an "Annotated Bibliography of HEP Information" which provides the first centralized source of info on HEP ammunition

Ref: S.G. Smith, Editor, "State of the HEP Ammunition Art. Basic HEP Research and Development Program," Chamberlain Corp, Waterloo, Iowa Summary Rept (Oct 1960) (Contract DA-11-D22-501-ORD-2140)

Hept-RDX. See 1,3,5-Trinitro-1,3,5-triazacycloheptane listed under Triazacycloheptane

HEPTANE AND DERIVATIVES

Heptane, Dipropylmethane, Heptylhydride, $\text{CH}_3(\text{CH}_2)_5\text{CH}_3$; mw 100.23, colorless liq, mp -90.5° , bp 98.4° , fp 25°F , d 0.684 at 20° , RI at 20° , 1.3876, insol w, sol org solvs. Obtd by fractional distillation of petroleum. Irritating to respiratory tract; narcotic in large concs. Dangerous when exposed to ht or flame

Refs: 1) Beil 1, 154 2) Sax (1968) 806 3) Cond Chem Dict 8th Ed (1971), 437

Azidoheptanes, $C_7H_{15}N_3$, mw 141.25, N 29.75.

The following derivs are described in Beil:

1-Azido-heptane. $N_3CHC_6H_{14}$; liq, bp 74° at 18mm, d 0.868 at 20° , RI at 20° 1.4343. Prepd by action of NaN_3 on 1-chloro or 1-iodo heptane (Ref 1)

2-Azido-heptane. $H_3CCH(N_3)C_5H_{11}$; liq, bp $65-66^\circ$ at 20mm, d 0.862, RI 1.4323 at 20° . Prepd from 2-chloroheptane & NaN_3 ; $NaN_3 + Hg(OAc)_2 + 1$ -heptane (Ref 2)

3-Azidoheptane, 3-Triazoheptane or 3-Heptylazide. $C_2H_5CH(N_3)C_4H_9$; liq, bp $79-81^\circ$ at 43mm (Ref 2), d 0.858 at 25° , RI at 25° 1.4298 (Ref 3); $\Delta H_f^\circ = -29$ kcal/mole (Ref 4) prepd in sealed tube reaction of 3-iodoheptane with NaN_3 in aq MeOH (Ref 2)

Refs: 1) Beil 1 {434} <396> 2) P. Levene et al, J Biol Chem 120, 759 (1937) & CA 32, 487 (1938) 3) P. Levene & A. Rothen, J Chem Phys 5, 985 (1937) & CA 32, 1151 (1938) 4) J.W. Murrin & G.A. Carpenter, Mem- Rept No 129, US Nav Powd Fact, Feb 1957

4-Azidoheptane. $(C_3H_7)_2CH(N_3)$; liq, bp $64-65^\circ$ at 20mm, d 0.864 at 20° , RI 1.4327 at 20° . Prepd from 4-chloro-heptane + NaN_3

Refs: 1) Beil 1 <396 & 397> 2) C.H. Heathcock, Angew Chem Intn Ed 8, (2), 134 (1969) & CA 70, 86930 (1969)

1,7 Diazidoheptane (called **Heptandiyldiazid** in Ger). $N_3(CH_2)_7N_3$; mw 182.27, N 46.12%; liq, bp 116° at 5mm, RI 1.4700 at 20° . Prepd from 1,7-Dibromoheptane + NaN_3

Ref: Beil 1 <397>

Many nitro and nitroso derivatives are also known:

4-Nitroso-4-nitroheptane. $H_3C(CH_2)_3C(NO_2)NO(CH_2)_2CH_3$; mw 160.20, N 17.49%, rh crystals, mp $72-73^\circ$ with decomp, sl sol in eth. Prepd from $C_3H_7C:NOH + NO_2$ in cold eth in dark. Oxidation with CrO_3 in HAC gives **4,4-dinitroheptane**. No expl props mentioned for either
Ref: Beil 1, 156

Dinitroheptanes, $C_7H_{14}(NO_2)_2$, mw 190.23, N 14.73%. The following derivs are known:

1,1-Dinitroheptane. $(NO_2)_2CHC_6H_{13}$; liq, bp 81° at 1 mm, d 1.091 at 20° , RI 1.4432 at 20° . Prepd by reacting 2-hexylacetoacetic acid-Et ester with aq nitric acid

Ref: Beil 1, <396>

1,7-Dinitroheptane. $O_2NC_7H_{14}NO_2$; pale yellow liq, bp $198-200^\circ$ at 10mm, RI 1.458 at 20° (Ref 2).

Prepd from 1,7-diodoheptane + $AgONO$ in eth; the decarboxylation of 2,8-dinitrononanedicarboxylic acid (Ref 2)

Refs: 1) Beil 1, (57) 2) H. Feur & C. Savides USP 2963515 (1960) & CA 55, 20958 (1961)

3,5-Dinitroheptane. $C_2H_5CH(NO_2)CH_2CH(NO_2)C_2H_5$; needles (from MeOH), mp 33° , bp $115-116^\circ$ at 3mm, d 1.09, RI 1.4453 at 20° (Ref 4). Prepd by reacting 1-nitropropane with 2-nitro-a-butene in alc; heating 1-nitropropane with paraformaldehyde in presence of Et_2NH ; from 2-nitrobutene and K-salt of 1-nitropropane in alc soln at 10° (Ref 4); $EtCH(NO_2)CH_2OAc$ in MeOH, H_2O , NaOH soln reactd with $PrNO_2$ & Triton-B catalyst (Ref 2)
Refs: 1) Beil 1 {434} <396> 2) G.L.

Shoemaker & R.W. Keown, JACS 76, 6374 (1954) & CA 49, 15891 (1955) 3) H. Feiver & R. Miller, JOC 26, 1348 (1961) & CA 56, 1334 (1962) 4) V.P. Tsybasov & V.F. Petrovich Izv Vyss Uchebn Zav Khim i Khim Techn 5, 942 (1962) & CA 59, 3756 (1963)

2,4-Dinitroheptane. $H_3CCH(NO_2)CH_2CH(NO_2)C_4H_9$; bp 98° at 3mm, d 1.10 at 20° , RI 1.4482 at 20° . From 2-nitropropane and K-salt of 1-nitrobutene in alc at 10°

Ref: V.P. Tsybasov & V.F. Petrovich IzvVyss-UchebnZavKhim i KhimTechn 5, 942 (1962) & CA 59, 3756 (1963)

Heptanedinitrile, 4,4-Dinitro or 4,4-Dinitropimelonitrile. $CN(CH_2)_3C(NO_2)_2(CH_2)_3CN$; mw 240.25, N 23.33%; cryst, mp 79° . Prepd from $HC(NO_2)_2:NO_2K + CH_2:CHCN$ in water at $35-45^\circ$ (Ref 1); or $(NO_2)_2C(CH_2OH)_2 + CH_2:CHCN$ in aq KOH (Ref 2). Claimed as an ingredient in rocket propellant charges (Ref 3)

Refs: 1) L. Herzog et al, JACS 73, 749 (1951) & CA 45, 5609 (1951) 2) H. Feiver & S.M. Pier, JACS 76, 105 (1954) & CA 49, 2313 (1955) 3) M.H. Gold & L. Herzog USP 2918489 (1959) & CA 54, 8637 (1960)

Trinitroheptanes, $C_7H_{13}(NO_2)_3$, mw 235.23, N 17.87%, ob to $CO_2 -98.6\%$. The following isomers are known:

1,1,1-Trinitroheptane, $(O_2N)_3CC_6H_{13}$; liq, bp 80° , d 1.212 at 20° , RI 1.4482 at 20° . Prepd from $C_6H_{13}I + AgC(NO_2)_3$ in MeCN

Refs: 1) Beil, not found 2) G.S. Hammond et al, Tetrahedron 19, Suppl 1, 185 (1963) & CA 59, 11237 (1963)

3,3,5-Trinitroheptane. $C_2H_5C(NO_2)_2CH_2CH(NO_2)C_2H_5$; liq, bp 108–110° at 0.005mm, RI 1.4685 at 25°. Prep'd by heating 1,1-dinitropropane in a soln of 2-nitrobutylacetate in MeOH, w & NaOH at 40–45° for 2 hrs. Claimed to be a high explosive

Note: Among the polynitroheptanes this is the only found reference to their being explosive

Refs: 1) Beil, not found 2) K. Klager, USP 3000968 (1961) & CA 56, 3715 (1962)

2,6-Dichloro-2,4,6-trinitroheptane. $CH_3CCl(NO_2)CH_2CH(NO_2)CH_2CCl(NO_2)CH_3$; mw 304.11, N 13.82%; cryst, mp 73–119°. Prep'd by adding the product of reaction of aq base & $ClCH_2CH_2NO_2$ to a soln of 2-nitroallylacetate in CH_2Cl_2 and heating 3 hrs at 53°. Further chlorination with Cl_2 in basic MeOH gave the 2,4,6-trichloro-2,4,6-trinitroheptane

Refs: 1) Beil, not found 2) M.B. Frankel et al, USP 3440282 (1969) & CA 71, 91105 (1969)

Tetranitro derivs were not found in the literature

2,2,4,6,6-Pentanitroheptane. $CH_3C(NO_2)_2CH_2CH(NO_2)CH_2C(NO_2)_2CH_3$; mw 325.23, N 21.54%, OB to CO_2 –46.7%. Prep'd by reacting 2-nitro-3-acetoxy-1-propene with 1,1-dinitroethane

Refs: 1) Beil, not found 2) M.B. Frankel, Tet 19, Suppl 1, 215 (1963) & CA 59, 11236 (1963)

Hexanitroheptanes, $C_7H_{10}(NO_2)_6$; mw 370.23, N 22.70%, OB to CO_2 –30.2%. The following isomers are known:

1,1,3,3,5,5-Hexanitroheptane. $(O_2N)_2CHCH_2C(NO_2)_2CH_2C(NO_2)_2C_2H_5$. Claimed to be a burning rate accelerator for rocket fuels; no prep'n given in CA

Refs: 1) Beil, not found 2) M.B. Frankel, USP 3000970 (1961) & CA 56, 4618 (1962)

2,2,4,4,6,6-Hexanitroheptane. $CH_3C(NO_2)_2CH_2C(NO_2)_2CH_2C(NO_2)_2CH_2C(NO_2)_2CH_3$; crystals, mp 132°, d 1.70. Prep'd from 2,2,4,6,6-pentanitroheptane K-salt & N_2O_4 in CCl_4 at –15 to –25° for 4 hrs; or by nitric acid nitration of the pentanitroheptane (Refs 4 & 5); also from $MeNH_2$ & dichlorotetra-nitroethane (Ref 2). Its hot bar ignition temp is 338° & its sensitivity is approx that of pentolite (Refs 3 & 4)

Refs: 1) Beil, not found 2) M.B. Frankel & L.T. Carleton, Aerojet-Engineering Corp Rep 4, No 499, March 1951, Explosive Research – cont'd N7 onr 46208 3) D.V. Sickman & W.F. Sager, NAVORD Rept 486, (1954) Res & Devel in New Chemical High Explosives 4) George Washington Univ, Rep 4 Nos. 14, 15 and 16 on Con't NORD 9951, Task No 3 5) M.B. Frankel & K. Klager USP 3139461 (1964) & CA 61, 5517 (1964) 6) K. Klager & M.B. Frankel, Monatsh Chem 99 (5), 1438 (1968) & CA 69, 95857 (1968)

Heptanedioic Acid, 4,4-Dinitro also called 4,4-Dinitropimelic acid. $[HOOCCH_2C(NO_2)_2]_2$; mw 354.22, N 15.82%; cryst, mp 137°. Obt'd from its di-methylester, by refluxing with HCl, which is formed by reaction of $HC(NO_2)_2$: NO_2K and $CH_2:CHCO_2Me$ in water (Ref 1). It is claimed to be useful in propellant compositions (Ref 2)

Refs: 1) Beil, not found 2) L. Herzog et al, JACS 73, 749 (1951) & CA 45, 5609 (1951) 3) USP 2918489 (1960) & CA 54, 8638 (1960)

N,2,2,2',2',2'-Heptanitrodiethylamine. Designated as HOX, also called Bis-2,2,2-trinitroethyl-nitrazine or Bis(2,2,2-trinitroethyl)-nitrazine, abbr as BTNEN. It is listed as an expl deriv of Diethylamine in Vol 5, p D1224-R

Heptanitrohydrocellulose. See under Hydro-cellulose in this Vol

Heptanoic Acid and Derivatives

Heptanoic Acid or Enanthic Acid. $CH_3(CH_2)_5COOH$; mw 130.21, colorless, oily liq, mp –10°, bp 223.5°, d 0.913 at 25°, RI 1.4216 at 20°; sl sol in water; sol in alc & eth. Prep'd by oxidizing heptanal with dichromate & sulfuric acid. Low toxicity and flammability. Used in organic synth & production of special lubricants & brake fluid for aircraft

Refs: 1) Beil 2, 338, (144), [294] & {762}

2) CondChemDict, 8th Edit (1971), p 437

The following nitro deriv is described in the literature:

4,6,6-Trinitroheptanoic acid, Me ester. $MeOOC(CH_2)_2CH(NO_2)CH_2C(NO_2)_2CH_3$; mw 279.24, N 15.05%; needles (from eth), mp 56°. Prep'd from 4-nitro-4-pentanoate + $MeCH(NO_2)_2$ + NaOMe.

in MeOH at 40-45°; no explosive props are mentioned, but it must be expl

Refs: 1) Beil, not found 2) K. Klager, JOC 20, 650 (1956) & CA 50, 8576 (1956)
3) E.E. Hamel, Tetrahedron 19, Suppl 1, 85 (1963) & CA 59, 11228 (1963)

Heptanone and Derivatives

4-Heptanone, Dipropylketone or Butyrone.

(C₃H₇)₂CO; mw 114.21; colorless liq, mp -32.6°, bp 144°, fl p 120°, d 0.817 at 20°, RI 1.4073 at 20°; insol in water, sol in alc & eth. Toxicity undetermined; moderate fire hazard; used as a solvent and in polymers & resins

Refs: 1) Beil, *Dinitro*, C₇H₁₂N₂O₅, *Trinitro*, C₇H₁₁N₃O₇, *Tetranitro*, C₇H₁₀N₄O₉, and *Pentanitro*, C₇H₉N₅O₁₁, derivs were not found
2) CondChemDict, 8th Edit (1971), p 325

1,1,1,7,7,7-Hexanitro-4-heptanone. (NO₂)₃C-(CH₂)₂CO(CH₂)₂C(NO₂)₃; mw 384.21, N 21.88%, OB to CO₂ -20.8%; wht crystals (from aq MeOH), mp 121°. Prepd by heating (H₂C:CH)₂CO with HC(NO₂)₃. Explodes with hammer blow

Refs: 1) Beil not found 2) P.O. Tawney:USP 3038011 (1962) & CA 57, 7512 (1963)
3) M. Graff & W. Gilligan, JOC 33, 1247 (1968) & CA 68, 77654 (1968)

Heptryl. See 2-(2',4',6'-Trinitro-N-nitranilino)-2-nitrotymethyl-1,3-di-nitroxypropane under 2-Anilino-2-hydroxymethyl-1,3-dihydroxypropane in Vol 1, p A441

See ADDENDUM, p III in this Vol

Heracline. British explosive (1875), containing about equal amounts of each of the following compounds: KNO₃, NaNO₃, sulfur and sawdust, to which was added about 0.5% of Picric Acid

Ref: Daniel (1902), 373

Heraklin (Ger). An expl patented by Dickerhoff, was prepared by soaking sawdust in a concd aqueous soln of equal parts of Picric Acid & Amm nitrate. The resulting product was dried and mixed with various amts of pulverized sulfur and K or Na nitrate

Refs: 1) Gody (1907), 551 2) PATR 2510, (1958), Ger 88-1

Hercoblastings. (Called Kammerminensprengungen in Ger and Cámaras de mina in Spant). In this method which might be translated as *Chamber Mines Blasting*, a large area consisting of the material to be mined is selected and horizontal tunnels are drilled under it, deep in the ground. Then charges of explosives are placed in the tunnel, as shown, for example in Figs 259 & 260 copied from Ref 1, p 388. The layout of the Figs is for a basalt quarry blasting conducted in 1931 in Pfalz, Germany. All the shown charges were exploded simultaneously

This method also proved to be popular in blasting old asphalt or macadam pavements, where in order to obtain large pieces of material, expls of low detonation velocity and large

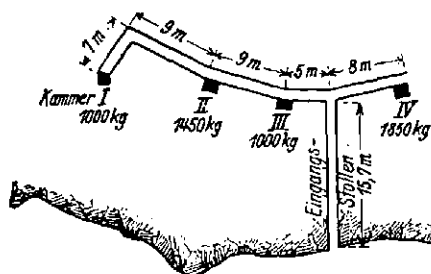

Lageplan 1:250

Abb 259

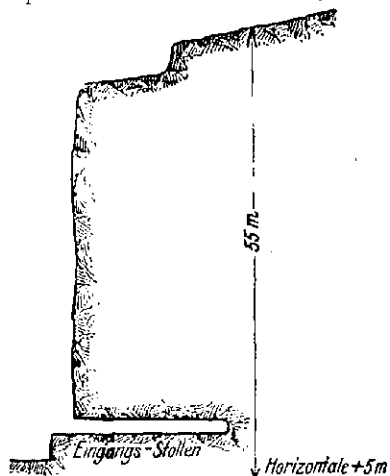

Schnitt durch den Eingangsstollen 1:250

Abb 260

Abb 259 und 260. Kammerminensprengung in Basaltgestein mit insgesamt 5300 kg Ammonit I und Ammogelatine I im Verhältnis 4:1

volume of gases produced on expln should be used. When blasting hard rock, expls with high deton velocity should be selected

In Refs 2 & 3 it is suggested that for blasting hard rock, tunnels can be dug deep underground and the charges are uranium-plutonium atomic devices instead of conventional explosives

Refs: 1) Stettbacher (1933), 397-88 2) Stettbacher (1948), 168 3) Stettbacher, Polvoras (1952), 212

Hercules Incorporated. Hercules Incorporated, known as *Hercules Powder Co* prior to 1966, a diversified, world-wide chemical company with estimated annual sales of about \$1 billion in 1973, began its corporate history on October 17, 1912. On that date, a decree of the federal court, under the Sherman Act, ordered the dissolution of the E.I. duPont de Nemours and Company, and a regrouping of the properties into the same company plus two new corporations. Hercules Powder Company and the Atlas Powder Company were the new corporations (Ref 3)

The name Hercules Powder was originally given to a dynamite manufactured by the California Powder Works as long ago as 1870 (Ref 1). This was obviously done with the object of comparing the strength of the dynamite to that of the mythological Hercules. Later, there existed a Hercules Powder Company, formed by Lammot duPont in 1882. It operated two dynamite plants whose operations were assumed by others, and its charter was cancelled in 1904. This historic name, and the brand name of the principal dynamite assigned to the new company were influential in the chosen name Hercules Powder Company

At the opening of business on January 1, 1913, Hercules Powder Company, incorporated in Delaware, began with nine black powder mills and two active dynamite plants:

<u>Black Blasting Powder Mills</u>	<u>Dynamite Plants</u>
Rosendale, NY	Kenvil, NJ
Ringtown, PA (2 mills)	Hercules, Calif
Youngstown, Ohio	
Pleasant Prairie, Wis	
Columbus, Kansas	
Santa Cruz, Calif	

"A" Blasting and Sporting Powder Mills

Hazardville, Conn
Valley Falls, NY

Black Powder mills began operating as early as 1843 and the dynamite plants began operations in about 1872, producing explosives for the iron, copper, gold, silver, and anthracite coal industries. During the intervening years between the 1870's and founding of Hercules Powder Company in 1912, many advancements in products and process technology had taken place. Low-freezing Nitroglycerin was known, gelatin dynamite was a commercial product, the use of active "dope" (sodium nitrate, coal, sulfur, rosin) was common. Ammonium Nitrate dynamite (extra dynamite) was also an important product. The importance of safety in coal mining had been recognized and use of hydrated cooling salts such as sodium carbonate, or magnesium sulfate had begun. Equipment for manufacture of dynamite such as the Talley mixer, and the Hall packing machine were operational. In principle at least, this equipment design is still in use today

In addition to dynamite manufacture, the Kenvil plant was equipped shortly after the assignment to Hercules to manufacture about 1500 lbs/day of smokeless shotgun and rifle powder. The brands which became Hercules property included Bullseye* and Unique*. These brands still exist today

In 1914 the Independent Powder Company of Missouri was acquired, with its dynamite plant near Joplin, Missouri

In 1914-1915 a new dynamite and black blasting powder plant was constructed and began operation at Bacchus, Utah

During the years of World War I the Kenvil and Hercules plants were equipped to manufacture TNT. Capacity eventually reached 7,000,000 lbs/month. In addition, Hercules operated the Nitro, West Virginia smokeless powder plant for a short time. The Union plant in Gillespie, NJ, was also acquired by Hercules for production of smokeless propellant and later for manufacture of nitrocellulose for dynamites and lacquer as well. Total Hercules production of smokeless propellant during World War I was over 100,000,000 lbs. In addition,

A gasless delay fuse which did not require venting was developed for electric caps. This new design improved water resistance and helped prevent misfires or burning of the explosive charge. In addition, semi-gelatin, permissible dynamites containing sodium chloride as a coolant were developed. A broader range of Hercomite* brands of low-cost ammonium nitrate dynamites was introduced. The practice of seismic exploration required explosives with reliable performance after exposure to high water pressures for long periods of time, and so the Vibrogel* seismic gelatins were developed. Red Dot* smokeless shotgun powder was first used, and has been used by champions in trap and skeet shooting ever since.

In the late 30's and early 40's blasting caps for seismic use were developed which enabled the user to determine to within a few tenths of milliseconds the instant of detonation by monitoring the cap circuit. These caps were named Vibrocaps*. Dynamite packaging improvements also followed. Long lengths of thick paper cartridges were developed to enable them to be threaded, or screwed together to improve loading into the borehole. This was Hercules patented Spiralok*. In addition, the paper shell for other dynamites was improved so that it could be loaded into boreholes and then expanded without previously having been slit with a knife. This so called Tamptite* method of shooting resulted in better performance due to better coupling of the explosive in the borehole to the media to be blasted and had the additional advantage of making the loading operation safer for the miner. Currently plastic shells have replaced Spiralok in seismic use.

In World War II Hercules was called upon to conduct research programs to develop new types of ordnance, particularly propellants for guns and rockets. The first bazooka propellant grains were extruded at the Kenvil plant, and many other propellant processing and application improvements followed. Hercules designed, constructed and operated Radford Arsenal, and Sunflower and Badger Ordnance Works for the U.S. Government. These plants turned out all the rocket propellants fired by U.S. Forces during World War II, as well as a substantial portion of the conventional propellants for guns

and mortars. In addition Hercules operated the New River bag loading plant, and Volunteer TNT plant. Hercules continued as the contractor for Radford and Sunflower after the war, and in addition, assumed responsibility for the operation of the Allegany Ballistics Laboratory for the Navy. Propellant charges for such operational missiles as Nike, Honest John, Little John, Talos, Terrier, and Rat were designed and developed at ABL (Ref 4)

In about 1953, ANFO (ammonium nitrate and fuel oil) figuratively exploded on the scene of the blasting industry. The market for large diameter, low cost dynamites was rapidly taken over by the even lower cost ANFO. Hercules and other explosives suppliers faced a diminishing dynamite market, and excess capacity. Hercules Black Powder plants had all been closed by this time due to lack of a market, and dynamite came under pressures of excess capacity. However, innovations in explosives had not yet ceased. In the early 50's, Hercules introduced long-length small diameter dynamite cartridges (king-size) for improved economy in loading into boreholes. Hercules patented the equipment design for packaging such long lengths and demand for these products has continued. Improvements in static resistance of blasting caps were introduced as Vibrocap SR* in the mid 50's. Vibronite B* was introduced for a high volume, but short-lived history in offshore seismic operations. It is a blasting agent packaged in metal cans to withstand the rigors of handling storage and use in offshore seismic operations.

Vibrocol*, long length (ca 65 ft or more), pre-packaged columnar charges of explosives were especially suited for some land seismic exploration. Low-priced, packaged blasting agents, Dynatex* and Tritex* were useful in wet locations where ANFO could not be used.

The Chemical Propulsion Division of Hercules was formed in 1958, and began construction of a major facility for design development and manufacture of large rockets and propellants at the Bacchus, Utah plant. In 1958 Hercules acquired the design, development, and production facilities of Young Development Laboratories of Rocky Hill, N.J. The filament-wound, glass fiber-reinforced plastic Spiralloy* structures

*Indicates registered trademark.

operations for manufacture of acetic acid and acetone were conducted

In 1921 Hercules last major acquisition in the explosives business was Aetna Explosives Company. With this acquisition came the following active plants:

Emporium, Pa — Dynamite
 Ishpeming, Mich — Dynamite
 Birmingham, Ala — Dynamite & black powder
 Goes, Ohio — Black powder
 Port Ewen, NY — Blasting caps
 Prescott, Ontario — Fulminate

Electric blasting caps as well as regular blasting caps were added to the Hercules product line with the Aetna acquisition. The plant at Port Ewen, NY had been in operation since 1913. The features of the electric caps which were manufactured at Port Ewen included the insulated wires, copper shell, a base charge (pressed fulminate) an electrical heater (bridge wire), primer (loose fulminate), plug, water-proofing, and sulfur seal. These caps were intended to fire instantaneously when electric current was applied. By 1927 delay electric caps had been developed at Port Ewen, and were commercially available (Ref. 2). The design of the delay fuse required venting of the delay element

In its first 25 years, (ie from 1912 to 1937) Hercules Powder Company introduced many additional innovations. In 1929 Hercules Powder Company introduced a patented semi-gelatin dynamite called Gelamite*. It was an advance in the art due to its ability to replace gelatin dynamites where extreme water resistance was not required, with substantial cost savings. produced at Rocky Hill proved to be of great importance for rocket cases, motor housings, nose cones, and fuel tanks because of their strength and light weight. From this beginning, Hercules developed the Spiralloy* rocket cases into production scale rockets. Along with the cases, Hercules high energy propellants achieved a breakthrough in mass fraction for high performance space motors and upper stages of ballistic missiles. The Minute Man missile system was one of major importance to the nation and to Hercules Chemical Propulsion Division in these early days. Following the success of the Minute Man, Hercules has also done significant design, development and production work on

the Polaris and Poseidon Systems

In 1958 Hercules began producing N_2O_4 , most of which has been used by the Air Force and NASA as an oxidizer in liquid propulsion systems

In the late 1950's and early 1960's the entire explosives industry was intensively working on a new explosive system, which has since become known as *water-gel* or *aqueous slurry explosives*. Hercules was among the leaders in innovation and promotion of water gels. Packaged Fogel*, an aqueous solution of oxidizing salts sensitized with smokeless powder became a forerunner of many such products. The product was packaged in plastic bags. It found ready acceptance on the Iron Ranges of Minnesota and Michigan where jet-pierced boreholes could now be completely filled with this gelled explosive, to improve the blasting performance. The economy, water resistance, and safety of these water gel systems were a significant marketing attraction. Early in the 1960's, Hercules also began to supply water gels in bulk trucks, pumped directly into the borehole, and due to the added savings in labor costs, the use of this concept rapidly accelerated nationwide

A highly significant technological improvement in blasting technique, called *pre-splitting*, using dynamite was introduced by Hercules in 1961. Through the use of precise drilling and special blasting procedures this technique could produce very precise shearing to improve the appearance & durability of the remaining rock, and the economy of construction blasts. This has become a standard technique where over-break is undesirable, and is widely used in highway construction

In the late 1960's Hercules water-gel explosives were being used nationwide in bulk operations and packaged products. *Sturrex* was a Hercules patented method of gasifying water gels to produce improved performance due to increased sensitivity and energy output

SuperSeis* a patented explosive system for offshore seismic exploration, jointly developed by Hercules and Western Geophysical Company, became operational in 1971. It consists of small explosive charges that are ejected from the exploration boat via a long pressured tube and detonate after an appropriate delay, at

water depths of ca 40 feet. Because these charges are percussion initiated they are safer than the conventional electrically initiated seismic charges (Ref 5)

The product outlook for the future includes the Trident 1, C-4 undersea long-range missile, which is a joint effort of Hercules and Thiokol Chemical Corporation. The work is carried on at the Bacchus and ABL facilities. In addition work continues on Polaris and Poseidon missiles, land-based minuteman missiles and other rockets. Advanced composites are finding increasing use in structural applications requiring high strength and modulus with minimum weight. Explosives water-gel products will probably accelerate in market acceptance and use because of increased safety in handling and shipping. Their future use in small cartridges to replace NG dynamites is likely to increase

The third 25-year span of Hercules explosives, smokeless powder and propulsion activities is continuing with the following principal manufacturing facilities:

Bacchus, Utah — Propellants; rockets
 Bessemer, Ala — Dynamite, nitric acid, PETN, water gel
 Carthage, Mo — Dynamite, water gel
 Donora, Pa — Ammonium nitrate, nitric acid
 Hercules, Cal — N_2O_4 nitric acid, ammonium nitrate
 Ishpeming, Mich — Water gel
 Kenil, N J — Smokeless powder, diazo
 Louisiana, Mo — Ammonium nitrate, nitric acid
 Parlin, N J — Nitrocellulose
 Port Ewen, N Y — Detonators, initiators
 Rocket Center, W Va — Propellants
 Radford, Va — Government owned, company operated
 Sunflower, Kansas — Government owned, company operated

which manufacture the following products:

BLASTING CAPS

No 6 Strength Initiators: aluminum shell No. 6 strength initiators for explosives set off from the spit by the safety fuse

ELECTRIC BLASTING CAPS

Coaldet:* copper-bronze alloy shell, static-resistant, waterproof, millisecond delay electric blasting caps designed especially for use in the coal mining industry. Available in eight accurately timed delays with nominal firing times

from 25 through 500 milliseconds. Firing times are printed on blasting cap shell as positive and permanent identification of delay. In addition, Coaldet electric blasting caps are furnished with water-resistant tags that display the delay number in easy-to-see numerals and leg wire insulation is color-coded in a brilliant, high gloss that is color-distinguishable in an underground coal mine environment. All Coaldet blasting caps have iron leg wires for magnetic removal and all conform to the U S Bureau of Mines permissible recommendations

Instadet:* bronze shell No. 6 strength, static-resistant, waterproof, instantaneous initiators for explosives set off by an electric current. Available with various length leg wires of copper or iron as required

Millidet:* bronze or aluminum shell No 8 strength, static-resistant, waterproof, millisecond delay electric blasting caps with delay elements supplying 18 controlled (0 to 17 periods) firing times from 12 to 700 milliseconds with no overlapping of delay periods. Available with various length leg wires of copper or iron as required

Superdet:* No 8 strength bronze or aluminum shell static-resistant, waterproof, approximately ½-second delay electric blasting caps with delay elements supplying 19 controlled (0 to 15 periods plus ¼, ½, and ¾ fractional delay periods) firing times from 12 milliseconds to 15.6 seconds with no overlapping of delay periods. Available with various length leg wires of copper or iron as required

Vibrodet SR:* static-resistant, No 8 strength E.B. caps designed to meet the requirements of the seismographic industry for a high-quality, no time lag, waterproof E.B. cap. Vibrodet SR WW is a self-disarming Vibrodet SR designed for offshore blasting work. Vibrodet types are available with copper leg wires only

BOOSTERS

Titan Booster 25, 150, 225, 350, 500, and 2500:* high-strength, relatively insensitive explosive initiators designed for use with commercial explosives, slurries, and blasting agents. The Titan Booster 25XT is a specially designed, self-disarming booster for offshore seismographic work

The self-disarming Titan Booster 25XT and Vibrodet SR WW, aimed at eliminating the

possibility of primed offshore blasting charges being washed ashore, have proved very effective and, as safety devices, were quickly adopted by the offshore seismic industry

DETONATING CORD

Detonating Cord: core of pentaerythritol tetranitrate (PETN) contained within a waterproof covering of textile or plastic; available in several grades, each on spools of 500 or 1,000 feet. Manufactured by the Ensign-Bickford Company, Coast Fuse, Inc and Austin Powder Company

SAFETY FUSE

Safety Fuse: internal burning fuse with black powder core for conducting flame from collar of blasthole to blasting cap or to black powder charge. Hercules Incorporated markets various grades manufactured by The Ensign-Bickford Company and Coast Fuse, Inc

BLASTING MACHINES

Condenser-Discharge Type: Hercules Incorporated markets five condenser-discharge blasting machines: VME 450, VME 225 Blasters: manufactured by Vibration Measurement Engineers, Inc., Evanston, Ill 60204

Hercules Permissible 20-Shot Blaster: manufactured by Femco, Inc, Irwin, Pa 15642

SD-50, SD-100: manufactured by Safety Devices, 6505 Lignum Street, Springfield, Va 22150

Generator-Type: manually operated electric generators for initiating electric caps. Four styles: two 10-cap, a 30-cap, and a 50-cap machine manufactured by Fidelity Electric Company, Lancaster, Pa 17604, for Hercules Incorporated

SQUIBS

Electric Squibs: means for initiating black powder electrically; supplied with leg wires of 4- and 6-foot lengths

BLASTING ACCESSORIES

Blasting cap crimpers, blasting galvanometers, connecting wire, explosives magazines, fuse lighters, Ignitacord* and Quarrycord* connectors, leading wire, detonating cord clips and connectors, Quarrycord, rheostats, tamping bags, and V A O blasting meters

EXPLOSIVES

Nitroglycerin Dynamites: in cartridges ranging from 7/8 to 8-inch diameter with varying weight strengths:

Blasting Gelatin	Hercomite*
Ditching Dynamite	Hercon*
Extra Dynamite	Hercosplit
Gas-Well Explosives	High-Pressure Gelatin
Gelamite*	Nitroglycerin
Gelatin	Dynamites
Gelatin Extra	Oil-Well Explosives
Hercol*	Stumping Dynamite
	Unigel

Permissible Dynamites: Nitroglycerin-based explosives tested and approved by the U.S. Bureau of Mines as safe for use in blasting in gaseous and dusty coal mines, provided they are stored and used in accordance with conditions established by the Bureau of Mines:

Collier-C*	Red H C
Hercogel*-A	Red H D
Red H*A	Red H F
Red H B	Red H L

Seismograph-Grade Explosives: for use in seismic prospecting on land and offshore. Various grades are available in diameters from 2 to 8 inches packaged in fiber cartridges, metal cans, or plastic:

Gelamite S	Vibrogel 5
Vibrocol*	Vibronite* S Primer
Vibrogel* 3	

BLASTING AGENTS

Ammonium Nitrate Prill and Fuel Oil Mixtures (AN/FO): available in 50- and 80-pound multi-wall paper bags, packages from 5 to 12 inches in diameter, and in bulk deliveries to field storage bins or direct to the blasthole:

Freemix 3	Hercomix 1-4
Freemix 33	Hercomix T
Hercomix*	

Nitro Carbo Nitrate Blasting Agents: a series of low-cost blasting products containing no "high explosives" ingredients. They have limited water resistance and are available in varying cartridge strengths and packages with diameters of 3 inches and up:

Dynatex*	Tritex* 2
Dynatex WR	

Seismograph-Grade Blasting Agents:

Vibronite B	Vibronite' S
Vibronite B High	Vibronite S-1
Energy	

Super AN/FO: ammonium nitrate and fuel oil mixtures with metal additives to obtain increased strength. Super AN/FO is available in packages or can be delivered direct to the blasthole in bulk form.

BLASTING AGENT INGREDIENTS

Herco-Prills*: ammonium nitrate prills designed for use with No 2 diesel fuel oil to produce a nitro carbo nitrate blasting agent. Herco-Prills are readily absorbent, nonsetting, and offer excellent fuel oil absorbency. Available in bulk, and in 50- or 80-pound multiwall, moisture-resistant bags

SLURRY BLASTING MATERIALS

Slurrex: is a major technological breakthrough by Hercules in blasting with slurry explosives. Developed through the Hercules Energy Management concept, Slurrex provides a varying-density technique to any slurry formula for obtaining a precise amount of volume energy in the borehole. This is caused by the injection of a chemical reagent at the time of bulk loading or packaging. This chemical reagent provides millions of tiny gas bubbles that act as "hot spots," or initiating surfaces, to improve the efficiency of the detonation reaction. Hercules is able to design very precisely a formula for maximum energy and then vary the volume energy with no significant formula change. As an example of the value of this energy control, Hercules is able to provide any level of measured volume energy from 50 million to 110 million ft-lbs/cu ft. The Slurrex technique is usually applied to produce the maximum measured energy at the bottom of the hole. There the gas bubbles, or "hot spots," are more highly compressed than they are at the top—hence, an optimum energy and density result where these factors are most needed. Each succeeding foot up the borehole has a different energy level, and this directly meets the blast requirements at each horizon on the face. This patented technique, exclusive with Hercules, can be applied to any of its slurry products

Nitro Carbo Nitrate (NCN) Slurries: plastic, water-resistant products that consist essentially of inorganic nitrates, fuels, and metals, in which none of the ingredients are classified as explosives; must be detonated by adequate-strength Titan Boosters. Available in various formulations in either packaged or bulk forms, both of which offer the Slurrex blasting technique
Flogel*: water-resistant, highly plastic, non-nitroglycerin slurry explosives classified as a Propellant Class B for shipping purposes.

Must be detonated by adequate-strength Titan Boosters. Available in various grades in either polyethylene bags or bulk, both of which offer the Slurrex blasting technique

PROPELLANTS**GRANULATED DOUBLE-BASE TYPES**

(for use in guns)

Blue Dot*: a premium powder designed especially for magnum shotshell loads

Bullseye*: for use in loading pistol and revolver cartridges

Green Dot*: designed for use in medium shotshell loads for all gauges, also some revolver and pistol loads

Herco*: coarse grain, for use in heavy and magnum shotshell loads, also some revolver and pistol loads

Hercules Red Dot*: especially suited for use in light and standard shotshell loads in all gauges, also some revolver and pistol loads

Hercules 2400*: progressive-burning; for use in small-capacity center-fire rifle cartridges, for reduced loads in larger capacity rifle cartridges, for 410-gauge shotshells, and high-velocity loads in some revolvers

HiTemp*: for use in oil-well perforator guns when exposure to high temperature is important

Military Propellants: a wide variety of compositions for standard or special applications

Unique*: an all-around propellant for use in pistol and revolver cartridges, light or gallery rifle loads, and light through heavy shotshell loads

ELECTRIC INITIATORS, EXPLOSIVE DEVICES, ASSEMBLIES, SUBSYSTEMS,

Actuators	Gas generators
Bellows motors	Igniters
Blasting caps	Indicators for EED's
Blasting supplies	Piston actuators
Bolts, explosive	Primers
Boosters	Safe and arm systems
Cartridge actuators	Separation devices
Destruct units	Simulators
Detonators	Squibs
Dimple motors	Switch modules
Electroexplosive devices	Switches
Explosive actuators	Thrusters
Flame initiators	Time-delay devices
Flash squibs	
Fuze subassemblies	
Gas actuators	

CHEMICAL PRODUCTS

Ammonium Nitrate: special purified product for industrial chemical use, available in solution, prill, and grained form. Also high-density grained material for formulation of military explosive compositions

Composition D-2 Wax: a desensitizing compound containing wax, nitrocellulose, and a wetting agent; used in military explosive formulations

Diazodinitrophenol (Diazo): yellow, crystalline compound used as priming charge in blasting caps

Mixed Nitrating Acids: a mixture of nitric and sulfuric acid in various ratios and adjusted to the desired DVS values (dehydrating value of sulfuric acid)

Mixed Oxides of Nitrogen (MON): mixtures of N_2O_4 and NO in various proportions as required up to 40% NO

Nitric Acid: basic chemical of commerce available in strengths 57 to 98%

Nitric Acid, Red Fuming: strong nitric acid containing free NO_2 . Available in strengths up to 30% NO_2 . Also made with and without HF corrosion inhibitor

Nitric Oxide (NO): powerful nitrosating agent in organic reactions. Available under 500 psig in cylinders and tube trailers. A conversion unit is also available for the manufacture of NO from N_2O_4 at the point of use. This is attractive to the large user because it reduces the freight cost

Nitrogen Tetroxide (N_2O_4): an energetic and versatile oxidizer, nitrator, and nitrosator. Available as a liquid in steel cylinders and tank cars under moderate pressure (0 to 10 psig)

Nitrogen Trioxide (N_2O_3): especially useful for organic nitrosations and the in situ manufacture of nitrosyl sulfuric acid and sodium nitrite. Also used as an oxidizing agent. Available in same shipping containers as nitrogen tetroxide

Pentaerythritol Tetranitrate (PETN): white, crystalline compound used as a detonating agent in blasting caps and detonating fuse

CHEMICAL PROPULSION SYSTEMS**PROPULSION SYSTEMS****AND GAS GENERATORS**

Complete solid-fueled rocket motors and gas

generators for all applications from tiny satellite spin-control rockets to propulsion for large ballistic missiles, such as Poseidon, Polaris, and Minuteman. A wide variety of systems are in development and production using metal and Spiralloy* motor cases and both composite and double-base solid propellants

Hercopel: a unique all-epoxide cure composite solid propellant with excellent mechanical and ballistic properties. Its outstanding performance in extended environments makes it well suited for tactical missiles

Double-Base Solid Propellants: a wide variety of physical and ballistic properties which can be tailored to meet specific performance requirements. Their high specific impulse and excellent reproducibility are two of the many reasons Hercules double-base propellants are found in many of our rocket motors and gas generators used for both military and space applications

ADVANCED SYSTEMS**ADVANCED COMPOSITE MATERIALS**

Advanced composite materials from Hercules consist of high-strength, high-modulus graphite fibers that have been preimpregnated with polymer matrices. These materials possess strength-to-weight ratios greater than steel; uses include fabrication of aerospace and aircraft structures, industrial equipment, and other structures or systems requiring high strength and modulus with minimum weight. Hercules capabilities include production of the graphite fibers and materials as well as research, development, design and production of the structure or systems that utilize them

Written by C. W. EILO

Refs: 1) Mining & Scientific Press, San Francisco, Ca, April 23, 1870 2) Hercules Detonators Booklet, 1927 3) A.P. Van Gelder & H. Schlatter, "History of the Explosives Industry in America," Columbia University Press, 1927 4) W. Haynes, "American Chemical Industry, Van Nostrand, NY (1949) 5) H.L. Fitch, Hercules Explosives Engineer (1) (1971), p 2

Hercules powder. No 1: NG 75.00, KNO_3 2.10, $MgCO_3$ 20.85, $KClO_3$ 1.05, sugar 1.00%. No 2: NG 40.00, KNO_3 31.00, $MgCO_3$ 10.00, $KClO_3$ 3.34, sugar 15.66%

Thorpe (Ref 3) gives two formulas for Hercules powders: (1) NG 77, NaNO₃ 1, wood-pulp 2, MgCO₃ 20, strength 106% of Guhr Dynamite No 2. (2) NG 42, NaNO₃ 43.5, wood-pulp 11.0, MgCO₃ 3.5, strength 86% of Guhr Dynamite No 1

Refs: 1) Cundill (1889) in MP 6, 12 (1893)
2) Daniel (1902), 374 3) Thorpe (1917), 438
4) Giua, Trattato VI (1) (1959), 345

Herculite. A perchlorate explosive which was at one time on the British "Permitted List". KClO₄ 27/NG 33/collodion cotton 1/woodmeal 9/NH₄ oxalate 29/H₂O 1; limit charge 16 oz
Ref: Barnett (1919), 137

Herculine. One of the old mining explosives containing KNO₃ together with sawdust and camphor. Other ingredients were also added
Ref: Daniel (1902), 374

HERO (Hazards of Electromagnetic Radiation to Ordnance). Any Ordnance Item is defined as being "HERO UNSAFE ORDNANCE" when:

- 1) Its internal wiring is physically exposed;
- 2) Tests are being conducted on the item that result in additional electrical connections to the item;
- 3) EED's (Electroexplosive Devices) having exposed wire leads are present, handled or loaded;
- 4) The item is being assembled or disassembled; or
- 5) The item is in a disassembled condition (Ref 1)

If such unsafe ordnance is exposed to RF (radio frequency) fields above a certain amplitude level, sufficient RF energy can be induced into the firing circuits to explode the EED's. Therefore, for the handling of HERO UNSAFE ORDNANCE, restrictions of field intensities to certain levels, such as the 0.g volts per meter maximum for the 2 to 32 MHz (mega Hertz) range, have been established to ensure safe operations. These criteria levels are specified in Ref 1, which is confidential

Refs: 1) Anon, "Radio Frequency Hazards Manual", NAVORDOP 3575/NAVAIR 26-1-529
2) Anon, "Excerpt from HERO Newsletter No 30, Jan 1970, Commander US Naval Weapons Center, Attn Mr. R.M. Price, Code TE-2, Dalgren, Va 22448 3) G. Cohn, Edit, Expls&Pyrots 3 (5), 1970 4) US Spec MIL-I-23659C, "Initiators, Electric; Design and Evaluation of" (Aug 1972)

Hertz Theory of Impact is described in the Mathematical Theory of Elasticity by A.E.H. Love, Dover Publications, NY (1944), p 198. This theory was applied by M.P. Murgai, JChemPhys 22, 1687-9 (1954) & CA 49, 2073 (1955) to calculate detonation properties of explosives

Herz, E. von (? - ?). German scientist who specialized in explosives. He was the author of numerous publications and patents. He proposed nitro-bis-diazobenzene perchlorate as an initiator and patented the use of Lead Styphnate in initiating compositions

Herz's Explosives. Patented in 1923 CA 18, 1573-4 (1924) BritP 207563, several compositions, such as ortho-, and para-nitrated quinone diazides of the polymeric phenols or their metallic salts either (1) as a top charge over a main (base) charge such as Tetryl, TNT, or PETN, or (2) in admixtures with other compounds. Following are the primary and nitrating compounds proposed by von Herz:

- 1) Bis[Dinitro-hydroxy-azo-quinone], called by v. Herz sym-Tetranitro-dioxy-diphenol-quinone-tetrazide, or Tetranitro-diresorcin-diazo-anhydride
- 2) Dinitro-dihydroxy-azo-quinone, called by v. Herz Dinitro-3,5-di-oxy-quinone-diazide, or Dinitro-phloroglucin-diazo-anhydride
- 3) Dinitro-hydroxy-azo-quinone, called by v. Herz Dinitro-m-oxy-quinone-diazide, or Dinitro-resorcin-diazo-anhydride
- 4) Mono-(and di-)nitro-hydroxy-azo-quinones, called by v. Herz Mono-(and di-)nitro-para-oxygenone-diazides, or Mono-(and di-)nitro-hydroquinone-diazo-anhydride

HES 4138. One of the Hercules Powder Co solventless sheet double-base, proplnts prepd and investigated during WWII: NC(13.13% N) 49.8, NG 40.0, Et Centr 1.0, K nitrate 1.5, DNT 6.0, DBuPh 1.5 & candelilla wax 0.2%
Ref: R.B. Corey et al, OSRD Repts 1103 (1942), 1 and 1558 (1943) 2

Hesilit. A Rus pre-WWI mining expl: NG (gelatinized with CC) 30.75/DNT 5.25/AN 18/rye meal or dextrine 39%
Ref: Anon, SS 12, 409 (1917)

HE SHELL. Same as High Explosive Shell

HE/SH Shell. High Explosive Squash Head Shell. See under HEP in this Vol

HESS, P. German scientist who designed several tests for explosives, such as Hess' Crusher Test, Deflagration Test etc. Author of several publications on physical testing of explosives:

Hess' Crusher Test (Hess' Brisance Meter). See Brisance Meter of Hess [See Vol 3 of Encycl, p C492-R, under *Compression (or Crusher) Tests*]

Hess' Deflagration Test. This test, which is no longer used, consisted of heating the explosive at 70° until spontaneous combustion (deflagration) took place (Ref 1). In a modified method, the explosive was heated at 75° under pressure until deflagration took place

Note: American investigator, A.P. Sy, also designed a "Deflagration Test"

Hess' Test. In this test, a sample of an explosive was heated at 70° in a current of air which was then passed into a solution of zinc iodide and starch. The time taken to impart a blue color to the solution was noted (Ref 2)

Refs: 1) Reilly (1938), 81 2) Ibid, 78

HET. Abbrev for High Explosive Tracer

Heterocyclic Compounds are ring structure carbon compns in which one or more of the atoms in the ring are not C. Frequently these other atoms are N. General refs to heterocyclic compns are:

Refs: 1) A. Weissberger (orig editor), "The Chemistry of Heterocyclic Compounds", Interscience; beginning in 1950 and contin thru present 2) R.C. Elderfield (Editor), "Heterocyclic Compounds", Wiley, NY, Vol 1, (1950) thru Vol 6 (1957)

Heuschrecke (Ger for Grasshopper). A series of weapon carriers (Waffenträger) such as for 105 mm Gun, developed by the Germans early in the WW II. They are described in vol III of the Illustrated Record of German Army Equipment 1939-1945, War Office, London (1947)

HEX (High Energy Explosive). Two types of these expl compns, HEX-24 and HEX-48 are described in Ref 2, pp 164-69

Origin: The development of "slow-burning"

expl mixtures which would produce increased blast effects in enclosed or nearly enclosed spaces directed attention to their use for possible military application. In 1950 PicArns developed a "high capacity" filler for 20mm projectiles consisting of 85/10/5-RDX/Al/desensitizer which was more powerful than Tetryl filler. However, in comparison with *MOX* (Metal Oxidizer Explosives) Type (described in Ref 2, pp 213-225) there was little doubt as to the superiority of *MOX* mixts. *HEX* mixts were developed at PicArns in 1953 by Sheffield & Murray (Ref 1) as superior high blast compns suitable for use in small caliber projectiles

The *HEX* compns were prepd by blending the appropriate weight of the dry ingredients in a Patterson-Kelly Twin-Sheli Blender for at least 30 mins

An alternate procedure for 100 to 200g batches used a Cradle-Roll Mixer. This device consisted of a half-barrel type container constructed of wood and lined with an electrical conductive material. A plastic roll was allowed to move over the ingredients by remote control action. The roll action prevented caking of the mixt but had no adverse effect on particle size of the ingredients. The period of time to obtn an intimate mixt was approx 15 mins

Compositions and Properties

Components, %	HEX-24	HEX-48
KClO ₄ (17 microns)	32	32
Al, atomized (20 microns)	48	—
Al, flaked (1 micron)	—	48
RDX (thru 325 mesh)	16	16
Asphaltum (thru 100 mesh)	4	4
Properties		
Molecular Weight	47.6	47.6
OB to CO ₂ , %	-42	-42
OB to CO, %	-34	-34
Powder, color	gray	gray
Density, apparent, g/cc	1.39	0.69
Density, pressed at at 20000 psi	2.1	1.62
Ballistic Mortar	Not Given	Not Given
Blast Effects	Not Given	Not Given
Brisance by Sand Test, g sand crushed	12.5	23.7
Brisance for TNT		48.0g
Detonation Rate	Not Given	Not Given

Properties (cont'd)

Explosion Temp, °C (5 sec)	520	545
Flame Temp, °K	2552	2382
Fragmentation	Not Given	Not Given
Friction Test, steel shoe	Detonates	Partially deton
Friction Test, fiber shoe	Unaffected	Unaffected
Gas Volume, cc/g	159	200
Heat of Combstn, cal/g	4197	4119
Heat of Expln, cal/g	1858	1735
Heat Test at 100°		
%loss in 1st 48 hrs	0.15	Not Detd
%loss in 2nd 48 hrs	0.00	Not Detd
Expln in 100 hrs	None	—
Hygroscopicity, %	None	Not Given
Impact Sensitivity	16 inches	Not Given
PicArnsApp, 2kg wt		(TNT 14)
Rifle Bullet Test	Not Given	Not Given
Sensitivity to Initiation (Min priming charge)	LA 0.20g Tetryl 0.25	LA 0.20 Tetryl 0.25
Storage	Dry	Dry
Trauzl Test	Not Given	Not Given
Vacuum Stability Test at 100°, cc/g/48 hrs	1.25	1.52
Usage, press-loaded at 20000 psi		HE filler for small caliber shells

Note: Above expl props are listed in Ref 2

Refs: 1) O.E. Sheffield & E.J. Murray, "Development of Explosives — Metallized Explosives — High Blast Fillers for Small Caliber Shell", PicArns Memorandum Report No **MR-49**, (Dec 1953)
2) US Army Materiel Command, "Explosives Series, Properties of Explosives of Military Interest", **AMCP 706-177** (Jan 1971), pp 164-69

Note: There are no US Military Specifications for HEX's

Hexa, Hexamin, Hexamit, Hexyl or Hexanitrodiphenylamine (HNDPhH). It is described in Vol 5, pp D1434-R to D1438-R, under **DIPHENYLAMINE AND DERIVATIVES**. Also in **PATR 2510** (1958), p Ger 88-R

Hexa S-22, S-26 and E4. German "Substitute Explosives" (Ersatz-sprengstoffe) used during WWII (See Vol 5, Table E15, p E122)

Hexachlorethane, Perchlorethane or Carbon Hexachloride. $\text{Cl}_3\text{C}\cdot\text{CCl}_3$; mw 236.72, mp 185°

(sublimes), bp 185.5° at 777 mm, d 2.091 at 20°/4°. Exists in three crystalline forms; usually as colorless rhombic crystals with a camphor-like odor. May be prep'd by the pressure chlorination of tetrachloroethylene in an enamel vessel and in presence of light (Ref 3). Nearly insol in w (0.005 at 22°) very sol in alc and eth. It is toxic, being similar in action to CCl_4 and results in lowered blood pressure, kidney and liver injuries. Explodes in mixtures with Zn powders, and to lesser extent Al powders (Ref 3). Used in smoke screen compositions (Ref 2), in explosive mixtures and pyrotechnics, and as a camphor substitute in celluloid and other NC plastics. Techn grade MIL-H-235A (See also Ref 5)
Refs: 1) Beil 1, 87, (26) & [58] 2) G. Reure, **MP 38**, 419-21 (1956) 3) A. Lamouroux & J. Meyer, **MP 39**, 435 (1957) & **CA 52**, 21107 (1958) 4) Kirk & Othmer 3, 773 (1949); 2nd edit 5, 166 (1964) 5) **CondChemDict** (1971), 440

Hexachloronaphthalene or Chloronaphthalene (Chlorinated white tar). $\text{C}_{10}\text{H}_2\text{Cl}_6$; mw 334.82. Crystals; prep'd by chlorination of naphthalene (Ref 2, 185). This comp'd is highly toxic (Ref 3). It was proposed as an addition (4–5%) to explosives containing large amounts of NaNO_3 together with NG, sawdust, etc. It is supposed to act as a sensitizer in these mixtures
Refs: 1) Beil, not found 2) J.W. Dawson & W.M. Dehn, **USP 2255653** (1941) and **CA 36**, 272 (1942) 3) **CondChemDict** (1971), 440

2,4-Hexadiyne-1,6-dihydroperoxide. See under **Diacylenic Dihydroperoxides**, Vol 5, p D1120-R

Hexaethylidenetetramine (called **Tricrotylidentetramin** in Ger). $\text{C}_{12}\text{H}_{24}\text{N}_4$; mw 224.40, N 24.97%; crystals (from hot water; forms numerous salts, some of which are unstable on heating (Ref 1)

It is reported that the comp'd is formed by the reaction of acetaldehyde-ammonia & ammonia (Ref 1). This reaction yielded a max of 87% gum from which the separation of not more than 3% of Hexaethylidenetetramine was possible. Nitration attempt of the product was not considered practicable. The above reaction is analogous to the hexamethylene-tetramine from which RDX is prep'd by

nitration, and was considered to yield a product which might be nitrated to Cyclo-triethylidenetrinitramine (Ref 2)

Refs: Beil 1, 730, [789] & [2980] 2) F.A. Smith, "Study of the Nitration of Hexaethylidenetetramine," *PATR* **414** (Sept 1933)

Hexahydrobenzene or Hexamethylene. See Cyclohexane and Derivatives in Vol 3, pp C595-L & R

Hexahydrocatechol. See Cyclohexanediol and Derivatives in Vol 3, p C595-R - C596-L

Hexahydro-1,3-dinitro-5-nitroso-5-triazine,

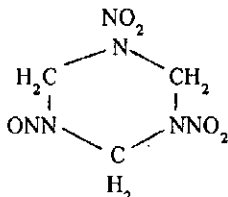

mw 206.15, N 40.78%; mp 165° (Ref 3) & 177° (Ref 2); sol in alc. Prepd by adding Cyclo-trimethylenetrinitrosamine to a soln of AN in concd sulf acid at -25°. Mixt is kept at -15° until all solid has dissolved and then warmed and filtered at 0° (Ref 3); 1,9-Diacetoxy-2,4,6,8-tetranitro-2,4,6,8-tetrazanone is reacted with a soln of 99% nitric, hydrogen peroxide & water at -40° to ppt subject material (Ref 2). Nitration of subj mat produces RDX (Ref 3)
Refs: 1) Beil, not found 2) A.F. McKay et al, *CanJRes* **27B**, 462 (1949) & *CA* **43**, 9073 (1949) 3) J. Simecek, *ChemListy* **51**, 2367 (1957) & *CA* **52**, 6367 (1958)

Hexahydro-3,6-dinitro-1,3,6-oxadiazepine or 3,6-Dinitro-1-oxa-3,6-diazacycloheptane,

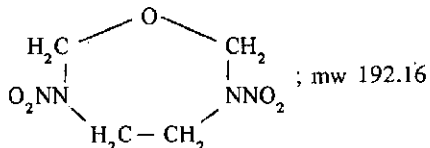

N 29.15%; crysts, mp 148-155° (Ref 3) & 154-155° (Ref 2). Prepd from $[\text{CH}_2\text{NHNO}_2]_2$ in 40% formalin reacted with acet anhyd at 20°, followed by digestion & hydrolysis at 65° (Ref 2); N,N-bis(piperidinomethyl)-ethylendinitramine refluxed in acetylchloride, then poured into iced water, the pptate is then

sequentially poured into MeOH & Et₂O. It is then dried & recryst from chl_f. The intermed thus formed, $[\text{CICH}_2\text{N}(\text{NO}_2)\text{CH}_2]_2$, on standing gives the subject product

Refs: 1) Beil, not found 2) W.J. Chute et al *CanJRes* **27B**, 503 (1949) & *CA* **43**, 9074 (1949) 3) J. Majer & J. Denkstein, *CollCzech-ChemCommun* **31**, (6), 2547 (1966) & *CA* **65**, 7042 (1966)

Hexahydro-1,3-dinitro-1,3,5-triazine Nitrate, PCX,

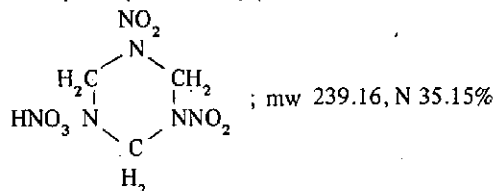

crysts, mp 99° (decomp); insol in cold alc & eth. Prepd by adding hexamine dinitrate to 93% nitric acid at -40°, then adding water and filtering ppt (Ref 4). PCX reacted with sulfuric acid gives RDX (Ref 4)

PCX is claimed to be an intermediate in RDX synth (Ref 2) but this claim is refuted in Ref 3

Refs: 1) Beil, not found 2) A.H. Vroom & C.A. Winkler *CanJRes* **27B**, 828 (1949) & *CA* **45**, 4727 (1951) 3) L. Berman et al *Ibid* **29**, 767 (1951) & *CA* **46**, 767 (1952) & *CA* **46**, 2084 (1952) 4) C. Holstead et al, *JChemSoc* **1953**, 3341 & *CA* **49**, 8311 (1955)

Hexahydro-1-(methoxymethyl)-3,5-dinitro-3-triazine or 1-Methoxymethyl-3,5-dinitro-1,3,5-triazacyclohexane.

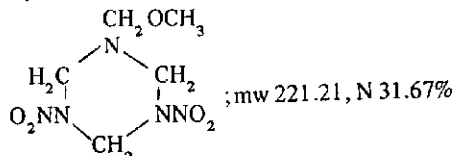

crysts (acet-chlf), mp 134°. Prepd by addn of 3,5-Dinitro-1,3,5-triazocyclohexane nitrate to a soln of MeOH and 40% aq formaldehyde (Ref 2); HNO₃ in SO₂ (at -30°) + (CF₃CO)₂O to give subject compd, mp 138° (Ref 3). Nitration of subj comp with HNO₃ was studied in Ref 4

Refs: 1) Beil, not found 2) K.W. Dunning & W.J. Dunning, *JChemSoc* **1950**, 2920 & *CA* **45**, 6643 3) R. Reed Jr. *JOC* **23**, 775 (1958) & *CA* **53**, 14113 (1959) 4) J.A. Bell et al, *JCS (C)* **1969**, 1556 & *CA* **71**, 49908 (1969)

Hexahydro-1-methyl-3,5-dinitro-s-triazine or 1,5-Dinitro-3-methylhexahydro-1,3,5-triazine.

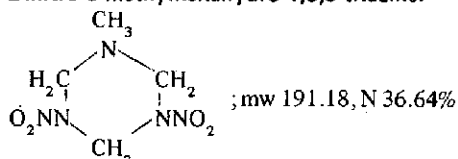

colorless rhomb crystals (from alc), mp 100-104° decomp. Prepd by adding alc soln of MeNH₂ to a soln of methylene dinitramine in 40% aq formaldehyde at 0°. No mention of expl props

Refs: 1) Beil, not found 2) F. Chapman et al, *JChemSoc* **1949**, 1838 & *CA* **44**, 1412 (1950)

Hexahydromethyl-s-triazatriborine, 1,3-Dimethylborazine, 1,3-Dimethylborazole or Dimethyltriborinetramine,

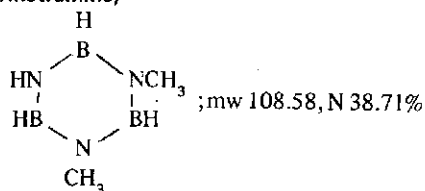

colorl liq, bp 108° (Ref 2), ΔH_{vap} 8275 cal/mole, Trouton's const 21.9 eu, hydrolyzes in water. Prepd by adding dimethoxyethane (DME) at 0° to a mixt of NaBH₄, CH₃NH₂HCl & NH₄Cl, when H₂ evolution ceases excess DME removed by vac dist and product pyrolyzed at 150° and distilled (Ref 4); B₂H₆ + CH₃NH₂ + NH₃ htd in bomb at 200° for ½ hour and fractionally distilled

An isomer, 2,4-Dimethylborazine,

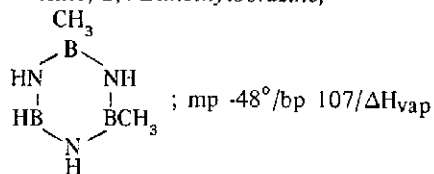

9230 cal/mole was prepd by reacting an excess of H₃B₃N₃H₃ with CH₃MgI in eth and purified by fractional distillation (Ref 3) & by heating monomethyldiborane with ammonia at 190° in a bomb (Ref 2)

Refs: 1) Beil, not found 2) H.I. Schlesinger et al, *JACS* **58**, 409 (1936) & *CA* **30**, 4421 (1936) 3) H.I. Schlesinger et al, *JACS* **60**, 1296 (1938) & *CA* **32**, 6570 (1938) 4) O.T. Beachley, *Inorg-Chem* **8**, (4), 981 (1969) & *CA* **70**, 111260 (1969)

Hexahydro-2-oxo-1,3-dinitropyrimidene or N,N'-Dinitro-N,N'-trimethyleneurea,

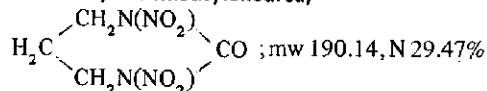

OB to CO₂ -50.5%; ndls (from alc), decomp in boiling water. Prepd from N,N'-trimethylurea and concd nitric acid

Refs: 1) Beil **24**, 5 2) A.P.N. Franchimont & H. Friedmann, *Rec* **26**, 218 (1907) & *CA* **1**, 2881 (1907)

Hexahydrophenol. See Cyclohexanol and Derivatives in Vol 3, pp C596-R & C597-L

Hexahydropropyrogallol. See Cyclohexanetriol and Derivatives in Vol 3, p C496-L & R

Hexahydroterephthalic Acid Diazide; 1,4-Cyclohexanedicarbonylazide (called Trans-Hexahydroterephthalsäurediazid in Ger),

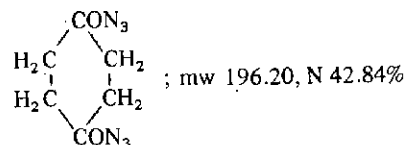

needles, mp 63° with decomp, insol in cold w; sol in ligroin, benz & eth. Prepd by reacting the 1,4-dihydrazid with NaNO₂ in s dil HAc Product decomp slowly on standing. On heating, decomposition becomes rapid and almost explosive. The 1,3 isomer may have been an intermediate in a synth of diamino-cyclohexane (Ref 2)

Refs: 1) Beil **9**, (318) 2) F.W. Hewgill & P.R. Jeffries, *JChemSoc* **1956**, 805 & *CA* **50**, 14571 (1956)

Hexahydro-3,5,7-trinitro-1,3,5,7-tetrazocine-1(2H)-methanolacetate or 1 Acetoxymethyl-3,5,6-trinitro-1,3,5,7-tetrazacyclooctane.

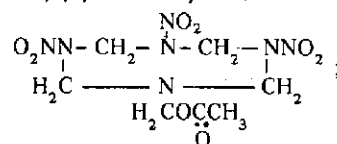

mw 335.28, N 29.25%; crystals, mp 152-53° (Ref 4), no recryst sol found. Prepd by adding 98% HNO₃ rapidly to 1,5 methylene-3,7 dinitro

1,3,5,7 tetrazacyclooctane in acet anhyd (Ref 2); or adding (in increments) 1 acetyl-3,7-dinitro-5-nitroso-1,3,5,7-tetrazacyclooctane to a soln of 30% H₂O₂ in 98% HNO₃ at -50° and raising temp to 0° for 12 hrs (Ref 3)

Refs: 1) Beil, not found 2) W.E. Bachmann & E.L. Jennet, JACS **73**, 2773 (1951) & CA **46**, 2085 (1951) 3) W.E. Bachmann & N.C. Deno, JACS **73**, 2777 (1951) & CA **46**, 2085 (1951) 4) R.A. Marcus & C.A. Winkler, CanJChem **31**, 602 (1953) & CA **47**, 12219 (1956)

Hexahydro-1,3,5-trinitro-1,3,5(1H)-triazepine or 1,3,6-Trinitro-1,3,6-triazacycloheptane, Cyclonite Homolog. See Vol 3, p C630. Additional data: nmr spectra (Ref 1); differential thermal analysis (DTA) gives 281° as the exotherm max (Ref 2)

Refs: 1) J.A. Bell & I. Dunstan, JChemSoc(C) (1966) 870 & CA **64**, 19616 (1966) 2) Y.P. Carignan & D.R. Satriana JOrgChem **32**, (2), 285 (1967) & CA **70**, 10960 (1969)

Hexahydro-3,5-trinitro-1,3,5-triazine. See Cyclo-trimethylenetrinitramine in Vol 3, p C611

Hexahydro-1,3,5-trinitroso-1,3,5-triazine. See Cyclo-trimethylenetrinitrosamine in Vol 3, p C630

Hexahydroxylamine Cobalt Nitrate, [Co(NH₂OH)₆](NO₃)₃; mw 443.20, N 28.45%. Decomposes explosively with a violent evolution of gas. See Refs
Refs: 1) A. Werner & E. Beil, Ber **38**, 897-98 (1905) 2) V.I. Belova & Ya. K. Syrkin, AkadNauk **30**, 109-19 (1955) & CA **50**, 9803 (1956) (Magnetic susceptibility of Co⁺⁺⁺ complexes in temp range 349-377°K)

Hexahydroxymethylbenzene Hexanitrate. See Hexamethylolbenzene Hexanitrate

Hexakis (2,2,2-trinitroethyl)-melamine,

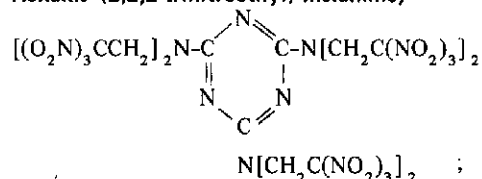

mw 1104.51, N 30.44%; red oil, which flashes on a hot plate but cannot be detonated by impact. Two synthetic routes to its prepn were considered to be unsuccessful: a) replace-

ment of the chlorine atoms of cyanuric chloride,

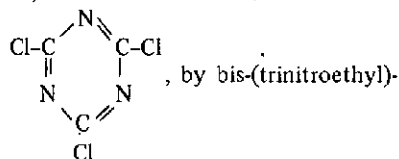

amine, [(O₂N)₃C-CH₂]₂NH, in the presence of pyridine; b) reaction of cyanamide with 2 molar equivalents of trinitroethanol to give bis-(trinitroethyl)-cyanamide, followed by trimerization of the latter

Refs: 1) Beil, not found 2) N.K. Sundholm, T.C. Richards & D.L. Schoene, Naugatuch Chem Div, US Rubber Co Progress Rept (15 Feb 1950 to 15 April 1950), NORD **10121**, p 4

Hexal. A Swiss explosive consisting of RDX & Al, particularly suitable for AA ammunition. Its d is 1.8, expln temp 225 (RDX 225°), Trngl value 420 cc (RDX also 420) & deton vel 7900 m/sec (RDX 8500) (Ref 1)

The Al is coated with a water-insol-wax to make it impervious to water-Al reactions that liberate hydrogen (Ref 2)

Refs: 1) PATR **2510** (1958), p Ger 88-R 2) P. Aubertein, FrF 1180530 (1959) & CA **54**, 20210 (1960) 3) M. Freiwald, Explosivst **6**, 133 (1961)

3,3,7,7,11,11-Hexamethanol-1,5,9-trioxacyclododecanehexanitrate or 1,5,9-Trioxacyclododecane-3,3,7,7,11,11-hexamethanolhexanitrate.

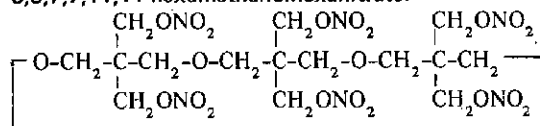

mw 624.45, N 13.46%, OB to CO₂ -53.8%; tacky solid. *Pentaerithritol* is polymerized with dil sulfuric acid and nitrated with 98% nitric acid at 0°. Used as sensitizer for AN explosives

Refs: 1) Beil, not found 2) J.A. Wyler, USP 2465776 (1949) & CA **43**, 6223 (1949)

2,3,5,2',4',5'-Hexamethylazobenzene-6-azide or 6-Azido-2,3,5,2',4',5'-hexamethylazobenzene. (CH₃)₃(N₃)C₆H₄N:N.C₆H₂(CH₃)₃; mw 307.44, N 22.78%; red ndls (from eth); mp 90-91°(dec); explodes mildly on rapid heating or on contact with concd H₂SO₄. May be prepd from 6-amino-2,3,5,2',4',5'-hexamethylazobenzene as described in Ref 2

Refs: 1) Beil **16**, 76 2) T. Zincke, H. Jaenke, Ber **21**, 546 (1888)

Hexamethyldiphenylmethane and Derivatives

Hexamethyldiphenylmethane also called 3,5-Dimethylphenylpropane

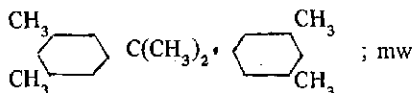

252.43; crystals (from alc), mp 174.5°. Prepd by treating *m*-xylene with 2,2-dichloropropane in the presence of AlCl_3 . Nitration with 65% nitric acid gives the *mononitro* and *dinitro* derivatives, neither of which is explosive, although the latter decomposes at 256°. Further nitration with 97% nitric acid produces the *tetranitro* derivative which decomposes at 295-300°

Hexanitrohexamethyldiphenylmethane or 2,2-Bis[2,4,6-trinitro-3,5-dimethylphenyl] propane,

$[(\text{CH}_3)_2\text{C}_6(\text{NO}_2)_3]_2\text{C}(\text{CH}_3)_2$; mw 522.43, N 16.09%, OB to CO_2 -107.2%; yellowish crystals (from isoamyl alc), color deepens on exposure to light; sl sol in warm isoamyl alc; decomposes with a *slight explosion* at 205°. Prepd by nitrating 2,2-Bis[2,4-dinitro-3,5-dimethyl-phenyl] propane with fuming sulfuric acid mixed with 97% nitric acid. It is an expl

Refs: 1) Beil 5, [527] 2) H. Goudet & F. Schenker, *Helv* 10, 134, 139 (1927)

3,3,6,6,9,9-Hexamethyl-1,2,4,5-1,2,4,5-tetroxane. See Acetone Compounds under 2,5-Bis(hydroperoxy)-2,5-dimethyl-hexene in Vol 2, p B144-R

Hexamethylenediamine and Derivatives

Hexamethylenediamine, 1,6 *Hexanediamine* (HMDA). $\text{H}_2\text{N}(\text{CH}_2)_6\text{NH}_2$; mw 116.24, N 24.10% silk-like leaves, mp 42°, bp 205° (subl), sol in water; sl sol in h eth. Prepd by hydrogenation of adiponitrile over Raney Ni or Co; chlorination of butadiene then reactn with NaCN & hydrogenation. Acute local irritant-mod flame hazard. Used in high polymer synth & as a cross-linking agent (Refs 1, 3 & 4)

In alc soln HMDA reacts with TNT to give the following derivs:

$\beta\text{TNT} = 3,3'$ -dimethyl-2,2'-6,6'-tetranitrodiphenyl-*N,N'*-hexamethylenediamine, mp 176-177°

$\gamma\text{TNT} = 4,4',6,6'$ deriv, mp 187-190°

With 2,4 $(\text{NO}_2)_2\text{C}_6\text{H}_3\text{Cl}$, HMDA reacts to give 2,2',4,4'-tetranitrodiphenyl-*NN'*-hexamethylenediamine, mp 206-208° (Ref 2)

Refs: 1) Beil 4, [597] 2) M. Giua & G. Musso,

GazzChimItal 84, 1114 (1954) & *CA* 52, 3707 (1958) 3) Sax (1968), 813 4) *CondChemDict*, 8th Ed, 443 (1971)

Hexamethylenediaminedinitrate or 1,6 Hexanediaminedinitrate. $\text{O}_3\text{NH}_2\text{N}(\text{CH}_2)_6\text{NH}_2 \cdot \text{HNO}_3$; mw 116.24, N 24.10%; wh crystals, mp 107.5°, ΔH_{comb} 998 kcal/mole, $\Delta H_f^\circ = 184.2$ kcal/mole (Ref 3). Prepd by reacting HMDA with nitric acid. It is used in castable propellants, in admixture with RDX & inorg nitrates, either as principal ingredient or as a flux (Ref 5). Dissolved in anhyd nitric acid it gives *NN'*-Hexamethyl-1,2,3-propanetriaminetrinitrate, mp 104-106°, which is used in two-component monopropellants (Ref 4)

The final product of the action of nitric acid on hexamine or hexamine dinitrate is RDX see Vol 3, p C614. At low temps, however a number of other compounds are produced (Ref 2). Dilution of the hexamine dinitrate-nitric acid reaction mixture at low temperatures with ethyl ether and subsequent treatment of the gum so obtained with methyl and ethyl alcohols and water severally leads to 1-alkoxy-3:5-dinitro-1:3:5-triazacyclohexane (IV), 1:3-dinitro-1:3:5-triazacyclohexane 5-nitrate (V), and methylenedi-1-(3:5-dinitro-1:3:5-triazacyclohexane) (VI). Dilution of the reaction mixture with methyl and ethyl alcohol produces mainly 3:5-dinitro-1:3:5-triazacyclohexane nitrate (II). 1-Methoxymethyl-3:5-dinitro-1:3:5-triazacyclohexane (IV; R = Me) has been synthesized from (II), methyl alcohol, and formaldehyde. 1:3:5-Trinitro-1:3:5-triazacyclohexane (I) has been synthesized from (V), acetic anhydride, and formaldehyde

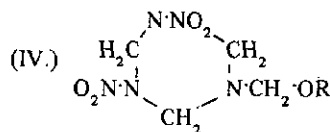
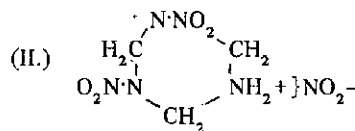
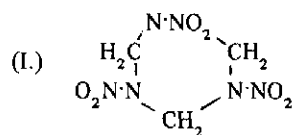

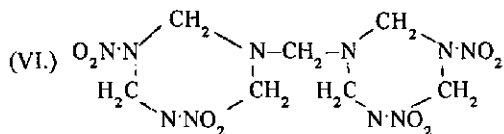
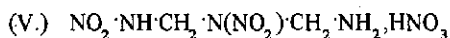

Refs: 1) Beil, not found 2) K.W. Dunning & W.J. Dunning, *JChemSoc* (1950) 2920 & *CA* **45**, 6692 (1951) 3) L. Médard & M. Thomas, *MP* **35**, 172 (1953) 4) H.M. Fox, *USP* 3212254 (1957) & *CA* **64**, 521 (1966) 5) G. Knöfler & A. Rost (1959), *GerP* 1059333 & *CA* **55**, 9880 (1961)

Hexamethylenediamine Peroxide.

$[(\text{CH}_2)_3\text{NH}_2]_2 \cdot \text{H}_2\text{O}_2$; mw 150.26, N 18.64%;
crysts. HMDA reacts with aq or ethereal H_2O_2
to give a solid adduct

Refs: 1) Beil, not found 2) Ya.A. Fialkov & A.A. Shokol, *UkrainKhimZhur* **15**, 318 (1949) & *CA* **48**, 5091 (1954)

Hexamethylenetetramine and Derivatives. *Hexamethylenetetramine (HMTA), Hexamethyleneamine, Hexin, Urotropine, Hexamine, Formincystogen, Aminoforn, Hex, Naphthamine or Uriton* (Ger)

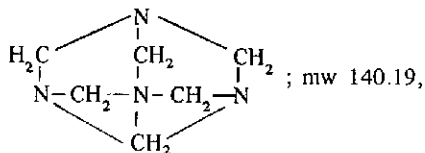

N 39.97%; colorless, odorless and sweet-tasting rhombic crystals; d 1.27 at 25° , mp 280° , when heated in a sealed tube it decomposes with charring at a temp above 280° ; when heated in air, it decomposes without melting; when heated in vacuum, it sublimes at $230\text{--}270^\circ$ without appreciable decomposition, η p 482°F

Was first prepd by Butlerov in 1860 by the action of gaseous ammonia on paraformaldehyde, also discovered by Butlerov. Hexamine was later studied by Duden and Scharf and other investigators, and a structural formula was assigned to it (Ref 1)

It is made continuously from gaseous NH_3 and HCHO (Ref 5) or in parallel flow of these ingredients, in the liq state (Ref 6). Another method involves the reactn of paraformaldehyde with liq NH_3 in an autoclave at 100° (Ref 8)

The impure product may be purified by dissolving it in H_2O and saturating the solution with NH_3 gas (Ref 3). The commercial product is usually about 99% pure, containing about 0.3% H_2O and 0.3% ash. There is also a USP product, which is nearly 100% pure

Hexamine readily dissolves in water with evolution of heat, producing a mildly basic solution; somewhat sol in alcohols and sl sol in ether and aromatic hydrocarbons

Walker (Ref 4) gives the following solubility values:

Water (grams of hexamine in solution)				
Temp ($^\circ\text{C}$)	0	25	50	70
Solubility	47.3	46.5	45.0	43.4

Solubility in other solvents (grams of hexamine per 100 ml of solvent)

	Room Temp	Elevated Temp
Petroleum ether	insol	insol
Ethyl ether	0.06	0.38
Absol ethanol	2.89	—
Methanol	7.25	11.93
Chloroform	13.40	14.84
Acetone	0.65	—
Benzene	0.23	—
Glycerol	20.9	—

When hexamine is ignited it burns with a pale blue flame. Its std heat of formation is $+29.65$ kcal/mole for the solid and 47.6 for the gas (Ref 2)

Pure hexamine may be taken internally by some persons in small amounts and it is used in medicine as a urinary antiseptic, but with some persons it is toxic. It can also be a skin irritant

Hexamine serves as a parent compound for the preparation of RDX, HMX & Hexamethylenetriperoxidediamine. It is also used in a mixture with sodium phenate, as an adsorbent of phosgene in gas masks. Its use as a cross-linking agent for guar gum in AN-slurry explosives has been patented (Refs 9 & 10)

An early review of the uses of hexamine in the explosive industry is given by Konrad (Ref 2). Also, see further under "Hexamethylenetetramine Explosives". Other more recent reviews are Refs 7 & 9. For the nitrosation of hexamine see Vol 3, pp C611-624

According to requirements of the US

Armed Forces as covered by Spec MIL-H-502A (June 1968), there are two grades of Hexamine (I & II) both of which must comply with the following requirements:

1. *Purity* – minimum 99.5%, maximum 100.2% (as determined by the method described below, under Tests)
2. *Formaldehyde* – none
3. *Ammonia* – max 0.02%
4. *Chlorides* – max 0.02%
5. *Ash* – max 0.05%
6. *Water insoluble material* – max 0.05%
7. *Solubility in glacial acetic acid* – completely soluble without turbidity

In addition, there are specific requirements for each grade

8. *Moisture* – max, Grade I, 0.50%, Grade II, 0.25%
9. *Granulation* – through U.S. Standard sieves, conforming to Federal Spec RR-S-366;
Grade I – sieve No. 16 – 100% (min), No. 60 – 30% (max), No. 100 – 10% (max)
Grade II – sieve No. 16 – 100% (min), No. 60 – 50% (max), No. 100 – 20% (max)

Refs: 1) Beil **1**, 583 (306) & 648 2) Dr Konrad, Nitrocellulose **5**, 123-4 (1934) & CA **29**, 1250 (1935) 3) T. Ohara JSocRubberInd Japan **10**, 438 (1937) 4) J.F. Walker, "Formaldehyde", 112, 120, 276-301, Reinhold Publ. Corp NY (1944) 5) F. Meissner et al, IEC **46**, 724 (1954) & CA **49**, 3797 (1955) 6) M. Weimann (GER) & CA **50**, 5041 (1956) 7) P.W. Sherwood, Petrol Refiner **37** (9), 351 (1958) & CA **52**, 18959 (1958) 8) M. Amagasa et al, BullChemResInst Non-Aq Solns, Tohoku Univ **7**, 7 (1957) & CA **53**, 18849 (1959) 9) F. Eiden, Deut Apoth Ztg **42**, 1348 (1961) & CA **56**, 9355 (1962) 10) D.S. Partridge USP 3496040 (1970) & CA **72**, 91877 (1970) 11) Y. Wakazono & Y. Otsuka USP 3524777 & CA **73**, 100647 (1970) 12) E.F. Westrum et al, JACS **92**, 7296 (1970) & CA **74**, 57970 (1971)

Hexamethylenetetramine-Chromium Compounds.

There are several explosives containing hexamine combined with either chromic oxide or chromic acids:

Hexamethylenetetramine-Chromium Tetroxide, $(\text{CH}_2)_6\text{N}_4 \cdot \text{CrO}_4$; mw 256.11, N 21.88%; reddish brn

yel crystals; was prepd by Hofmann (Refs 1 & 2) by the interaction of hexamine with chromic acid and 30% hydrogen peroxide

Very sl sol in water. Explodes (but not violently) on heating

Hexamethylenetetramine-Dichromic Acid.

$[(\text{CH}_2)_6\text{N}_4]_2 \cdot \text{H}_2\text{Cr}_2\text{O}_7$; mw 498.46, N 22.48%; yel crystals; was prepd by Cambier and Brochet (Refs 1, 2 & 3). Explodes violently

Hexamethylenetetramine-Tetrachromic Acid.

$[(\text{CH}_2)_6\text{N}_4]_2 \cdot \text{H}_2\text{Cr}_4\text{O}_{13}$; mw 698.46, N 22.48%; crystals; was prepd by Cambier and Brochet (Refs 1, 2 & 4). Explodes more violently than the previous compd

Lit search in CA (1947-71) revealed no other expl hexamine Cr compds

Refs: 1) Beil **1**, 586 2) R. Cambier & A. Brochet, BullSocChim, France (3) **13**, 394 (1895) 3) K.A. Hofmann, Ber **39**, 3183 (1906) 4) Walker, (1953), 288

Hexamethylenetetramine Explosive. A powerful solid explosive was claimed to have been prepd by oxidizing hexamine with a solution of hydrogen peroxide, treating the resulting product with nitric acid and then reoxidizing with H_2O_2 (Ref 1). After drying, this was mixed with AN, castor oil and turpentine (Ref 2)

Refs: 1) E.L.d'Asteck, USP 1835697 (1931) & CA **26**, 1125 (1932) 2) L.E. d'Asteck Callery, BritP415900 (1934) & CA **29**, 929 (1935)

Hexamethylenetetramine Explosives. Several explosive compositions containing hexamine in admixtures with oxidants or as chromium, copper nitrate, perchlorate, & peroxide compds are known. Several hexamine/oxidant mixtures have been patented as explosive & propellant compositions:

91/9% AN/HMTA used dry or as slurries (Refs 3 & 5); HMTA/ $\text{Al}_2\text{O}_3 \cdot 9\text{H}_2\text{O}/\text{KClO}_3$ (Ref 1); an HMTA-AN adduct prepd from aq solns or melts and mixed 1 part adduct to 4 parts AN (Ref 2); compositions that are detonator-sensitive consisting of 90/9/1% AN/HMTA/abiatic acid; prepd by making a homogenous melt at ca 145° and quickly cooling it to get finely crystal AN. This compd passed thru 16 mesh screens; and loaded into 1.5 inch diam steel tubes, deto-

nates at 18,700 ft/sec at d 1.24 & 13,400 ft/sec at d 1.44 g/cc (Ref 4)

The use of HMTA in AN slurry explosives is claimed in Refs 6 & 7

Refs: 1) M.R. Zhivadinovich & R. Zhivadinovich, USP 3066139 (1962) & CA 58, 6640 (1963) 2) W.E. Gordon, USP 3166555 (1965) & CA 62, 7580 (1965) 3) W.E. Gordon, Ger P 1186792 (1965) & CA 63, 4090 (1965) 4) W.E. Gordon, Brit P 1014071 (1965) & CA 64, 7962 (1966) 5) W.E. Gordon, USP 3247033 (1966) & CA 65, 566 (1966) 6) G.L. Griffith, USP 3344743 (1967) & CA 67, 118752 (1967) 7) D.S. Partridge, USP 3496040 (1970) & CA 72, 91877 (1970)

Hexamethylenetetramine Nitrates. The following nitrates were reported to have been prepd by various investigators:

Hexamethylenetetramine Mononitrate. $(\text{CH}_2)_6\text{N}_4 \cdot \text{HNO}_3$; was prepd by Delepine by the action of dilute HNO_3 on aqueous solns of hexamine at 0° (Ref 4)

When more concentrated acid is used, the dinitrate is obtained

Hexamethylenetetramine Dinitrate (HDN) (Hexamine Dinitrate). $(\text{CH}_2)_6\text{N}_4 \cdot 2\text{HNO}_3$; mw 266.22, N 31.57, OB to CO_2 -78.1%; white crystals; d 1.63, mp 160-165°, ΔH_{comb} 3583 cal/g, ΔH_f° -92.8 kcal/mole (Ref 9). UV spectra for both the mono and dinitrates are given in Ref 11. May be prepd by nitration of hexamine with mixed nitric-sulfuric acid. For this, Hale (Ref 6) gradually added nitric acid (d 1.42) to a 25% aqueous solution of hexamine at 0° . The precipitated salt was separated from the acid by filtration through glass wool and dried after washing with cold 50/50 alcohol-ether

It may also be prepd by passing formaldehyde into a cold or alcoholic soln of NH_3 and treating the resulting product with nitric acid (Ref 7)

The obsd low ylds in the nitration of hexamine have been ascribed to the formation of Trinitrodiaminodimethylamine, $\text{O}_2\text{NN}(\text{CH}_2\text{NNO}_2)_2$ (Ref 10). Further nitration of hexamine-dinitrate with concd nitric acid gives RDX (See Vol 3, p C614)

If hexamine is treated with nitric acid, or Cyclonite Dinitrate with Ac_2O in sulfuric acid,

and then neutralized to a pH of 5.6, 3,7 *Di-nitropentamethylenetetramine* is claimed to be formed (Ref 12)

HDN is readily sol in water, but decomposes on standing. It is sol in alc, eth, chl_f & CCl_4

It is an explosive compound, which is less powerful and much less brisant than TNT

Power (by Trauzl Test) - 65% TNT; *Brisance* (by Sand Test) 18.1 g against 48 g for TNT, or 38% of TNT; *Impact Sensitivity* (with 2 kg weight), *Picatinny Arsenal* App 13" against 14" for TNT and 9" for Tetryl; *Bur of Mines* App 40 cm against 60+ for TNT and 26 cm for Tetryl; *Pendulum Friction Test* - negative; *Minimum detonating charge* for 0.4 g HDN is 0.24 g. Tetryl when initiated with 0.24 g MF; *Thermal Stability*, as determined by the 120° Heat Test - S.P. (salmon pink) 145 min, Red Fumes 300+ mins; no explosion in 5 hrs, which might be considered satisfactory; *Heat of Combustion* 948.4 kcal/mole

HDN is one of the intermediate products obtained during preparation of Cyclonite from hexamine. It has also been proposed for use in the manufacture of an explosive, tentatively considered to be 1,3,5-trinitrohexahydro-s-triazine (Ref 7). Its use in an AN-slurry expl has been patented (Ref 12)

Refs: 1) Beil 1, 586 (308) 2) Walker (1953) 288 3) H. Moschatos & B. Tollens, Ann 272, 280 (1893) 4) M. Delépine, BullSocChim France (3), 13, 353 (1895) and (3), 17, 110 (1897) 5) R. Cambier & A. Brochet, BullSoc Chim France (3) 13, 394 (1895) 6) G.C. Hale, JACS 47, 2754 (1925) 7) M. Elbe, Ger P 479226 (1927) & CA 23, 4822 (1929) 8) Dr. Konrad, Nitrocellulose 5, 123-4 (1934) 9) M. Delépine & M. Badoche CR 214, 774 (1942) & CA 38, 5138 (1944) 9a) Blatt, OSRD 2014 (1944) 10) Avogadro di Cerrione, Ann-ChimApplicata 38, 255 (1948) & CA 43, 4633 (1949) 11) Honorary Advisory Council for Scientific & Industrial Research, BritP 615419 & 615793 (1949) & CA 43, 9079 (1949) 12) H.R. Fee & R.W. Lawrence, USP 3318740 (1967) & CA 67, 55844 (1967)

Hexamethylenetetramine-Nitroform Salt.

$(\text{CH}_2)_6\text{N}_4 \cdot \text{HC}(\text{NO}_2)_3$; mw 291.27, N 33.70%, OB to CO_2 -79.6%; crystals, mp 145° (dec). It was prepd by refluxing for 1.5 hrs a mixt of hexamethyl-

ene tetramine & nitroform in abs alc until a yel flocculant formed. The ppt was filtered, washed twice with abs alc and once with ether. The product was not analyzed. Detonates weakly and burns easily

Refs: 1) Beil, not found 2) I.J. Schnaffner, US Rubber Co Quarterly Progress Rept No 5, (1 Oct 1948-1 Feb 1949), p 47

Hexamethylenetetramine Perchlorates. An explosive perchlorate was first prepd in 1916 by Riedel (Refs 1 & 3). It was the monoperchlorate. Later, Hassel (Ref 4) prepd the mono-, bi- and triperchlorates by treating an aqueous solution of hexamine with perchloric acid, with or without alcohol

Following are the properties of the mono- and diperchlorates:

Hexamethylenetetramine Monoperchlorate. $(\text{CH}_2)_6\text{N}_4 \cdot \text{HClO}_4$; mw 240.65, N 23.28%, OB to CO_2 & Cl_2 -96.4%, mp 158° . Crystals; easily sol in w imparting an acidic reaction to it

It is an explosive about 65% as powerful as TNT and less sensitive to impact (Ref 4)

Hexamethylenetetramine Diperchlorate. $(\text{CH}_2)_6\text{N}_4 \cdot 2\text{HClO}_4$; mw 341.12, N 16.43%, OB to CO_2 & Cl_2 -28.1%. Crystals. It is an explosive about 125% as powerful as TNT and comparable in sensitivity to impact to Tetryl. Lit search of CA (1947-71) uncovered no new refs to explosive HMTA Perchlorates

Refs: 1) Beil 1, (308) 2) J.B. Riedel, GerP 292284 (1916) 3) O. Hassel, NorwegianP 57831 (1937) & CA 31, 6466 (1937) 4) Blatt, OSRD 2014 (1944) 5) Walker (1953), 283 & 331

Hexamethylenetetramine Peroxides. The first compound of this type was prepd by von Girsewald (Refs 1, 2 & 3) in 1912 by evaporating under vacuum at $40-50^\circ$, the solution obtained by dissolving hexamine in a slight excess of 30% H_2O_2 containing a small amount of mineral acid, and then concentrating the product in vacuum. The resulting **Hexamethylenetetramine Hydroperoxide** (Hexamethylen-Wasserstoffperoxyd in German) was a colorless crystalline compound, readily sol in w & alc. It is an extremely explosive material which deflagrates on rapid heating or when brought in contact with concd H_2SO_4 . It is stable only to about 70°

Note: If instead of treating the free hexamine with peroxide, its salts are used (such as the citrate), or if hexamine is treated with peroxide in the presence of substantial quantities of acid, the resulting product is Hexamethylenetriperoxidodiamine (qv)

Another peroxide compound was prepd by Leulier (Ref 4) and repeated by v. Girsewald (Ref 5) on treating hexamine first with hydrogen peroxide and then with nitric acid. The resulting white crystals were presumed to be $\text{HN}:(\text{CH}_2\text{CH}_2\text{O}\cdot\text{OH})_2$; mw 137.14, N 10.21%. It is insol in w, alc, eth & other organic solvents. When wet, it is inactive, but when dry it is detonated violently by the blow of a hammer or when heated to about 130°

Refs: 1) Beil 1, (308) 2) Walker (1953) 289 3) C. von Girsewald, Ber 45, 2574 (1912) & CA 7, 346 (1913) 4) A. Leulier, JPharmChim 15, 222 (1917) & CA 11, 2277 (1917) 5) C. von Girsewald, Ber 54B, 490 (1921) & CA 15, 2416 (1921)

Hexamethylenetetramine Styphnate or Hexamine Styphnate. Probably $\text{C}_{12}\text{H}_{15}\text{N}_7\text{O}_8$ (struct formula unknown); mw 385.34, N 25.45%; crystals [from NM], mp $197-198^\circ$ by fast heating

Richmond et al (Ref 2) prepd it by adding one equivalent of hexamine to a satd aq soln of Styphnic Acid. The pptn of hexamine monostyphnate was quantitative; if the Styphnic Acid was saturated into ethanol instead of water, the loss by solubility in 1:1 water-ethanol was only 0.25 g per 100 cc of soln.

The mp was 196° (6° per minute rise). This styphnate is much more useful than picrate as a hexamine derivative largely because Amm Styphnate is sol in water or water-ethanol. Thus a soln contg one mole hexamine as a 50% soln plus 2 moles of ammonia gave a 98% yield of Hexamine Styphnate, mp 196°

Refs: 1) Beil, not found 2) H.H. Richmond et al, JACS 70, 3663 (1948) & CA 43, 1316 (1949)

Hexamethylenetetramino-Tetrazido-Copper. $(\text{N}_3)_2\text{Cu}(\text{CH}_2)_6\text{N}_4\text{Cu}(\text{N}_3)_2$; mw 435.33, N 51.49%; is described by Cirulis & Straumanis, JPrChem 162, 321 (1943) & CA 38, 1970 (1944). It is sol in aq ammonia, in Et diamine & in boiling dil nitric acid. It burns quietly in a flame but confined it explodes at $180-185^\circ$. With 1 kg falling weight it explodes at 10cm

Hexamethylenetetramine-Trinitro-m-cresylate.
 $(\text{CH}_2)_6\text{N}_4\text{C}_6\text{H}(\text{CH}_3)(\text{OH})(\text{NO}_2)_3$; mw 383.32, N 25.58%, crysts, mp 175° . Was first prepd by Datta et al (Ref 2) by mixing hot benzene-alcohol solutions of 1 mol of hexamine and 1 mol of trinitro-m-cresylate and then allowing to cool. The resulting compound exploded at 325°

Refs: 1) Beil, not found 2) R.L. Datta, L. Misra & J.C. Bardhan, JACS 45, 2432 (1923) 3) Walker (1953), 331

Hexamethylenetetramine Triperoxide and Hexamethylenetriamine Triperoxide. Depending on conditions $\text{HCHO} + \text{H}_2\text{O}_2 + \text{oxalic acid}$ (sic) give the tetramine or triamine peroxides. Their use as primary explosives has been patented

Refs: 1) Beil, not found 2) Gévelot and Gaupilat, FrP 893942 (1944) & CA 47, 8373 (1953)

Hexamethylenetriperoxidetiamine; 3,4,8,9,12,13-Hexaoxa-1,6-diazabicyclo-[4,4,4]-tetradecane (HMTD)(formerly called by Langler, Hexaoxymethylenediamine). $\text{N}:(\text{CH}_2\text{O}\cdot\text{O}\cdot\text{CH}_2)_3\text{N}$; mw 208.17, N 13.46%, OB to CO_2 -92.2%; d (cryst) 1.57; loading density 1.05 at 100 atm, 1.15 at 200 and 1.30 at 800 atm /mp 145° Colorless plates or rhombic crystals. IR spectra are given in Ref 19. Was originally prepd by Baeyer and Villiger (Ref 2) by adding 40% formaldehyde to a solution of ammonium sulfate in 3% H_2O_2 at 55° . Later C. von Girsewald (Refs 3, 4 & 5a) prepd it by dissolving hexamine and citric acid in 30% hydrogen peroxide

Taylor & Rinkenbach (Ref 6) modified the Girsewald procedure and prepd HMTD as follows:

a) Dissolve, with stirring, 56 g of powdered hexamine in a liter beaker containing 185 g of 30% hydrogen peroxide (or its equivalent of stronger solution up to 40%)

b) While cooling the beaker in water, gradually add, with stirring, 84 g of powdered, crystalline citric acid, keeping the temperature in the beaker below 30°

The following reactions taken place, as was suggested by Marotta and Alessandrini (Refs 7a and 16, p 289)

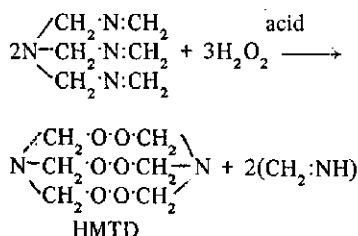

Trimethylenetriamine Ammonia also forms during this reaction, but it is absorbed by acid with formation of a salt

c) After all the acid has dissolved and the temperature starts to drop, stop the agitation and allow the beaker to stand overnight in a bath at room temperature

d) Separate the crystals by filtering through a Büchner funnel and rinse them with distilled water, followed by 95% alcohol (to facilitate the drying) and then dry in air

e) Allow the filtrate to stand until the next day and if there are any additional crystals, separate them out and purify as above. This method gives yields between 68.5 and 71%. Davis (Ref 15) uses a method of prepn which requires about 5 hours and cooling to 0° & below. Leulier (Ref 5) prepd HMTD from hexamine, hydrogen peroxide and nitric acid. Konrad (Ref 11) used the same procedure as of Taylor & Rinkenbach and also by treating 50 g of ammonium sulfate with 50 g of 30% hydrogen peroxide and 5 g of 40% formaldehyde.

Properties of HMTD were examined in detail by Taylor & Rinkenbach (Refs 6 & 7) and also by Konrad (Ref 11)

Solubility at 22° (g per 100 g of solvent): water 0.01; abs alc less than 0.01; ether 0.017; CS_2 less than 0.01; CCl_4 0.013; glacial acetic acid 0.14; chloroform 0.64; acetone 0.33; glycolacetate 0.90

HMTD is much more sol in hot water, especially on long standing. Its aqueous solns are stable

Solubilities in hot water:

At 60° after 2 hours 0.10%; 8 hrs 0.35; 24 hrs 0.50; 48 hrs 0.50

At 75° after 2 hours 0.25%; 8 hrs 0.60; 24 hrs 1.30; 48 hrs 2.25

At 100° after 2 hours 3.25%; 8 hrs 39.00%; 24 hrs 68.00

It is v slightly hygroscopic and does not seem to be toxic. HMTD is not compatible with most metals even when it is dry. It attacks Al, Sn, Zn, brass, Cu, Pb and iron (Ref 16). Mixtures of HMTD with PA, RDX, PETN and Tetryl appeared to be stable at 50° Mixtures of HMTD with TNT or KClO₃ were less stable (Ref 16)

HMTD is destroyed by caustic soln with liberation of ammonia (Ref 16). It can be nitrated at low temps using HNO₃ to give ca 26% RDX (Ref 18)

HMTD is an explosive of the initiating type; it is more powerful and brisant than MF, rather being comparable to LA and Cyanuric Triazide. It does not become dead-pressed even at pressures of 11000 psi (an advantage over MF)

Explosive properties:

Behavior Toward Flame; when a small quantity is ignited, it flashes like NC, giving a flame several inches in height

Brisance by Sand Test; 0.5 g at 1000 psi pressure crushes 42.5 g compared with 44.2 g for Cyanuric Triazide and 16.5 g for MF

Power by Trauzl Test, about 60% of TNT or 230% of MF (Ref 11)

Explosion temperature; explodes instantly at 200° or open flame; ignites in 3 secs at 149° when thrown on a heated metallic surface; explodes at 130° when heated gradually (Ref 16)

Friction Sensitivity; extremely sensitive

Heat of Combustion; 4295 cal/g at constant volume, H₂O liq

Heat of Formation, 385 cal/g or 80 kg cal/mol (Ref 10)

Impact Sensitivity, it is v sens to impact even when wet (Ref 16)

Velocity of Detonation, 4511 m/sec at d 0.88 in column 0.22" diam 5100 m/sec at d 1.1

Initiating Action, The minimum amounts of HMTD required to detonate 0.4 g of the following HE were determined by increasing the amounts of HMTD until the amount of sand crushed was at a maximum. (Explosives and initiator were loaded in No 8 cap at 1000 psi pressure)

TNT required 0.08 g using reinforcing cap and 0.10 g without reinforcing cap. PA required 0.05 g using reinforcing cap and 0.06

g without reinforcing cap. Tetryl required 0.05 g using reinforcing cap and 0.06 g without reinforcing cap. When 0.05 g HMTD was pressed at 1000 psi into a No 8 capsule, it detonated a stick of ordinary 40% dynamite and a stick of Blasting Gelatin which had become insensitive through age

HMTD is very unstable in storage. Its weight loss is 79% in 300 days at 50°, 150 days at 70° and 5 to 20 days at 90°, for material stored dry. Even under water it showed considerable decomp in 4 months (Ref 16)

Although C.v. Girsewald patented the use of HMDT as a primary explosive for detonators, its sensitivity to heat, friction and impact, its incompatibility with metals and its poor storage qualities make it unsuitable for practical use (Ref 16)

Refs: 1) Beil 27, 771 & (647) 2) A. Baeyer & V. Villiger, Ber, 33, 2479 (1900) 3) F. C. v. Girsewald, Ber 45, 2571 (1912) & CA 7, 346 (1913) 4) F.C. v. Girsewald, Ger P 263459 & CA 7, 3843 (1913) and 274522 & CA 8, 3122 (1914) 5) A. Leulier, JPharm-Chim 15, 222 (1917) & CA 11, 2277 (1917) 5a) F.C. von Girsewald & H. Siegens, Ber 54, 490 (1921) 6) C.A. Taylor & W.H. Rinkenbach, Army Ordnance 5, 463 (1924) 7) C.A. Taylor & W.H. Rinkenbach, JFrankInst, 204, 369 (1927) 7a) D. Marotta & M.E. Alessandrini, Gazz Chim Ital 59, 942 (1929) 8) E.L. d'Asteck, Brit P 339024 & CA 25, 2569 (1931) and USP 1835697 & CA 26, 1125 (1932) 9) H. Muraour, Bull Soc Chim, [4], 51, 1156 (1932) & CA 27, 603 (1933) 10) A. Schmidt, SS 29, 263 (1934) 11) Dr. Konrad, Nitrocellulose 5, 124 (1934) 12) Nuevos Explosivos Industriales, SA French P 783682 (1935) 13) M. Patry, SS 32, 177 (1937) 14) Bebie (1943) 81 15) Davis (1943) 451 15a) Blatt, OSRD 2014 (1944) 16) H. Ficherouille & A. Kovache, MP 31, 18, 25, 26 (1949) & CA 46, 11687 (1952) 17) Walker (1953), 289-331 18) K. Szyc-Lewanska & T. Urbanski, BullAcadPolonSci 6, 165 (1958) & CA 52, 18464 (1958) 19) E. Ferroni et al, ProcInternatMeetingMolSpectry, 4th, Bologna (1959) 2, 762 & CA 59, 8267 (1963)

Hexamethylolbenzene and Derivatives

Hexamethylolbenzene or Benzenehexamethanol.

$C(CH_2OH)_6$; mw 198.25; crystals, mp 302-311° (Refs 2 & 3), sol in w. Prepd from $C_6(CH_2OAc)_6$ + alc KOH (Ref 2); by trimerizing HC:CH₂OH with Ni(o) bistrimethyl catalyst under N (Ref 3) or Co(CO₃)NO catalyst (Ref 4)

Refs: 1) Beil, not found 2) M. Chaigneau, CR 233, 692 (1951) & CA 46, 7071 (1951) 3) N. von Kutepow & F. Meier, Ger P 1159951

(1963) & CA 60, 9198 (1964) 4) Anon, FrP 1397664 (1965) & CA 63, 8255 (1965)

Hexamethylolbenzene Hexanitrate or Benzene-

hexamethylhexanitrate. $C_6(CH_2ONO_2)_6$; mw 528.30, N 15.91%, OB to CO₂ -36.3%; wh powd, mp 176° decomp, ΔH_{comb} 2653 cal/g. Prepd by HNO₃ nitration of *hexamethylolbenzene* (Ref 2)

Impact sensitivity 3 cm or less with 2 kg wt on B of M machine; wt loss in 100° heat test: 0.70% first 48 hrs, 0.32% second 48 hrs, no expl in 100 hrs

Refs: 1) Beil, not found 2) H.J. Backer, RecTravChim 54, 833 (1935) & CA 30, 1367 (1936) 3) Blatt, OSRD 2014 (1944) 4) Pic-ArsnChemLabRepts 123718 & 123975 (1948)

Hexamine. Same as Hexamethylenetetramine, described on p H 79ff

Hexamine Derivatives are described under Hexamethylenetetramine on pp H80 to H84

Hexamine Explosives are described as Hexamethylenetetramine Explosives

Hexamit. See Novit

Hexamite (Called Hexanite or NTD₂ by the U.S. Navy; Schiesswolle 8 and TSMV 1-101 by the Germans; OtsuB or Type A by the Japanese). It consists of TNT 60/HeNDPhA 24/Al 16; greenish-gray solid, d 1.72, mp 80-90° (can be cast loaded); *Ballistic Strength* 130% TNT (due to the addn of Al); *Brisance* ca 46 g sand crushed vs 43 g for TNT; *Explosion Temp* 200-260°; *Deton Vel* 6900, m/sec; *Impact Sens* (Pic Ars app with 2 kg wt) 10" vs 14" for TNT; *Rifle Bullet Sensitivity*

detonates from the impact of .30 cal bullet, fired from a distance of 90 ft. It is stable and does not attack metals, but it is very toxic

Uses:

Germany: in mines, torpedoes, depth charges and Naval demolition containers

Japan: As type A explosive it was intended to be used in underwater ammunition to replace the type 97 explosive, TNT 60, HeNDPhA 40

Refs: 1) A. Stettbacher, Protar 9, 33-45 (1943) 2) H. Muraour, Protar 9, 62-63 (1943) 3) PBL Rept 53,045 (1945) 4) Op Nav 30-3M (1945), p 32 5) Allied and Enemy Explosives, Aberdeen Proving Ground, Md (1946) p 106 6) A. Stettbacher Spreng-und Schiesstoffe, Rascher, Zürich (1948) p 78

HEXAMMINES are Ammines or Ammoniates (described in Vol 1, pp A275-L to A286-R) contg six NH₃ groups. The following explosive hexammines are described in Vol 1:

Hexamminecadmium (II) Bromate,
[Cd(NH₃)₆](BrO₃)₂ (p A277)

Hexamminecadmium (II) Chlorate
[Cd(NH₃)₆](ClO₃)₂ (p A277)

Hexamminecadmium (II) Perchlorate
[Cd(NH₃)₆](ClO₄)₂ (p A277)

Hexamminechromium (III) Azide
[Cr(NH₃)₆](N₃)₃ (p A277)

Hexamminechromium (III) Nitrate
[Cr(NH₃)₆](NO₃)₃ (p A277)

Hexamminechromium (III) Perchlorate
[Cr(NH₃)₆](ClO₄)₃ (p A277)

Hexamminecobalt (III) Chlorate, Monohydrate or "Luteocobalttriammine Chlorate,"

[Co(NH₃)₆](ClO₃)₃·H₂O (p A280)

Hexamminecobalt (III) Chlorite, Monohydrate,
[Co(NH₃)₆](ClO₂)₃·H₂O (p A280)

Hexamminecobalt (III) Hexanitrocobaltate,
[Co(NH₃)₆]Co(NO₂)₆ (p A280)

Hexamminecobalt (III) Iodate,
[Co(NH₃)₆](IO₃)₃ (p A280)

Hexamminecobalt (III) Nitrate
[Co(NH₃)₆]I(NO₃)₃ (p A280)

Note: Addnl info is given below

Hexamminecobalt (III) Perchlorate, Monohydrate or "Luteocobalttriammine Perchlorate

[Co(NH₃)₆](ClO₄)₃·H₂O (p A280)

Hexamminecobalt (III) Perchlorate,
[Co(NH₃)₆](ClO₄)₃ (p A280)

Hexamminecobalt (II) Perchlorate,
[Co(NH₃)₆](ClO₄)₂ (p A280)

Hexamminecopper (II) Chlorate,
 $[\text{Cu}(\text{NH}_3)_6](\text{ClO}_3)_2$ (p A281)

Hexamminenickel (II) Azide,
 $[\text{Ni}(\text{NH}_3)_6](\text{N}_3)_2$ (p A281)

Hexamminenickel (II) Bromate
 $[\text{Ni}(\text{NH}_3)_6](\text{BrO}_3)_2$ (p A281)

Hexamminenickel (II) Chlorate,
 $[\text{Ni}(\text{NH}_3)_6](\text{ClO}_3)_2$ (p A281)

Hexamminenickel (II) Iodate,
 $[\text{Ni}(\text{NH}_3)_6](\text{IO}_3)_2$ (p A281)

Hexamminenickel (II) Perchlorate,
 $[\text{Ni}(\text{NH}_3)_6](\text{ClO}_4)_2$ (p A281)

Hexamminezinc (II) Chlorate,
 $[\text{Zn}(\text{NH}_3)_6](\text{ClO}_3)_2$ (p A282)

Hexamminezinc (II) Nitrate,
 $[\text{Zn}(\text{NH}_3)_6](\text{NO}_3)_2$, listed on p A282 but not described. It refers to Ref 23, which is D.B. Donskaya & M.A. Portnov, *ZhObshchKhim* **9**, 526-31 (1939) & *CA* **33**, 9091 (1939)
Ref: See Vol **1**, pp 1, 3, 7, 8, 10, 11, 11a, 14, 15, 16, 22, 23, 24, 39, 41, 42, 43, 46, 49, 67, 68, 69, 71, 72

Note: Destruction of cobaltic amines, such as of hexamine by means of thiosulfate in acid soln was described by L.M. Orlova, *ZavodLab* **8**, 502 (1939) & *CA* **36**, 6935 (1942), which is listed in Vol **1**, p A286-R

Hexamine, Calcium. Probably $\text{Ca}(\text{NH}_3)_6$. The compd decomposes explosively when heated in vacuum. The temp of explosion depends on the degree of vacuum. Products of the decomp are Ca nitride & hydride and hydrogen (Ref 1)

However, later studies (Ref 2) suggest that Ca Hexamine explosions are due to impurities which catalyze its decomposition
Refs: 1) E. Botolfsen, *BullSocChim* **31**, 56 (1922) & *CA* **16**, 4154 (1922) 2) A.C. Pappas, *ActaChemScand* **3**, 36 (1949) & *CA* **43**, 785 (1949)

Hexamine Chromic Perchlorate. $[\text{Cr}(\text{NH}_3)_6](\text{ClO}_4)_3$; mw 452.57. This inorg coordination compd was studied from the standpoint of its stab sensitivity vs loading density for possible use as an initiating compd. It was found to increase in sensitivity until an apparent max point was reached. The stab sensitivity of the compd also appeared to be affected by humidity. The compd exhibited a sensitivity of 28 inch-ounces as compared to 12 inch-

ounces for material dried over Ca sulfate (Ref 4)

See also Table A in Vol **1** of *Enycl*, p A277 and the following Refs
Refs: 1) W.R. Tomlinson, "Explosive Properties of Complex Compounds," *PATR* **1364** (Nov 1943) 2) *Ibid*, *PATR* **1632** (Oct 1946) 3) J.E. Abel et al, "Development of A New Ignition Temperature Apparatus," *PATR* **2093** (Nov 1954) (Activation Energy 29.82 kcal/mol vs 23.74 for Lead Azide & 29.81 for Mercury Fulminate) 4) A.C. Forsyth, S. Krasner & R.J. Gaughran, "An Investigation Concerning Stab Sensitivity Versus Loading Density of Some Initiating Compounds," *PATR* **2146** (Feb 1955)

Hexamminecobalt (III) Nitrate. $[\text{Co}(\text{NH}_3)_6](\text{NO}_3)_3$, mw 347.20, N 36.32%; sol in hot sl acid w; insol in alc; $\Delta H_f^\circ = -311.5$ kcal/mole (Ref 2). Prep'd by reacting a cobalt nitrate hexahydrate soln with AN and concd ammonia and then air oxidizing Co (II) to Co (III) or treating hexamine cobalt (II) chloride with concd nitric acid (Ref 1); by reacting $\text{Co}(\text{NH}_2)_3$ with AN in liq ammonia at 100° in an autoclave (Ref 3)

DTA and gas evolution curves are given in Ref 4. Explosive characteristics such as: output, impact sensitivity, and autoignition temp are given in Ref 6. Additional impact and friction sensitivity data are found in Ref 5 which also gives confined deton vel as 3000 m/sec & unconfined deton vel as 2700 m/sec
Refs: 1) J. Bjerrum et al, *Inorg Synth* **2**, 218 (1946) 2) K.B. Yatsimirskii & L.L. Pankova, *JGenChem (Russ)* **19**, 617-22(1949) & *CA* **43**, 7805 (1948) 3) O. Schmitz-Dumont, et al *ZAnorg-Chem*, **253**, 118 & *CA* **43**, 7805 (1948) 4) W.W. Wendlandt, *JInorgNuclChem* **25**, 545 (1963) & *CA* **58**, 12157g (1963) 5) Hartmut Preller, *Explosivstoffe* **12**, (8), 173-4 (1964) & *CA* **61**, 14455 (1964) 6) C.W. Hoppesch, et al *AmChemSoc, Div Fuel Chem, Preprints* **7**, (3) 235-41 (1963) & *CA* **63**, 2839 (1965)

Hexammons. See Gheksamony in Vol **6**, pG73-R

HEXANE AND DERIVATIVES

n-Hexane (called Hexan in Ger); $\text{CH}_3(\text{CH}_2)_4\text{CH}_3$; mw 86.17; colorless vol liq, mp -94.3° , bp 68.7° , $d_p -9^\circ\text{F}$, auto ignition temp 500°F , d of liq 0.659 at 20° , vap press 100 mm at 16° , $\Delta H_f^\circ = -39.96$ kcal/mol, refr index 1.3749; sl sol in w; sol in alc, acet, eth, and chl. Mod toxic in inhalation and ingestion; pure hexane reacts explosively with O_2 at 227° (Ref 2). Hexane occurs in crude petroleum and can be obtained by fractional distillation. It is used as a solvent, in low temp thermometers, as a paint diluent, and as a polymerization reaction medium. It is the parent comp for the following potentially expl derivs:

Refs: 1) Beil 1, 142, (51) [105] & {374} 2) C.F. Cullis, Bull Fr 1950, 863-8 & CA 47, 2689 (1953)

Azidohexanes, $\text{C}_6\text{H}_{13}\text{N}_3$, mw 127.22, N 33.04%. The following isomers are known:

1-Azidohexane, *Triazohexane* or *Hexyl Azide*. $\text{N}_3\text{CH}_2\text{C}_5\text{H}_{11}$; liq, bp $156-157^\circ$, RI 1.4325 at 20° (Ref 2), sol in eth, Q_{comb} 1045 kcal/mole, $\Delta H_f^\circ = -36.2$ kcal/mole (Ref 6). Prep'd by heating hexyl bromide, NaN_3 , aq MeOH in sealed tube for 6 hours; adding dropwise hexyl iodide to aq NaN_3 in aq PrOH & refluxing (Ref 4). Low toxicity less than NaN_3 (Ref 3)

Used as a foaming agent in caprolactam polymerization (Ref 5)

Refs: 1) Beil 1, {2533} & <358> 2) K. Henkel & F. Weygand, Ber 76B, 812 (1943) & CA 38, 1743 (1944) 3) F.E. Roth et al, Arch-InternPharmacol 108, 473 (1957) & CA 51, 10730 (1957) 4) E. Lieber et al, JOrg Chem 22, 238 (1957) & CA 51, 16279 (1957) 5) Belg-P 663494 & CA 60, 13411 (1964) 6) J.W. Murrin & C.A. Carpenter Mem Rept No 129, US Nav Powd Fact (1957)

2-Azidohexane. $\text{CH}_3\text{CH}(\text{N}_3)\text{C}_4\text{H}_9$; liq, bp $96-98^\circ$ at 160mm, RI 1.4353 at 20° , d 0.857, opt rot $+27.8^\circ$ at 25° (Ref 2). Prep'd by adding 2-iodohexane to NaN_3 in aq MeOH and heating in sealed tube

Refs: 1) Beil 1, {396} 2) P.A. Levene et al

Nitrohexanes, $\text{C}_6\text{H}_{13}\text{NO}_2$; mw 131.20, N 10.68%. The following isomers are known:

1-Nitrohexane, $\text{O}_2\text{NCH}_2\text{C}_5\text{H}_{11}$; colorless fluid

liq, bp $193-194^\circ$, d 0.949 at 20° ; insol in water; sol in alc. IR and UV spectra given in Ref 2.

Prep'd by reacting hexane with fuming nitric acid which also gives:

2-Nitrohexane, $\text{CH}_3\text{CH}(\text{NO}_2)\text{C}_4\text{H}_9$; liq, bp 176° , d 0.936 at 20° . It pyrolyzes unimolecularly with an activation energy of 40-45 kcal/mole (Ref 3)

Refs: 1) Beil 1, 147 & {395} 2) R.N. Haszeldine, JChemSoc 1953, 2525 & CA 48, 1812 (1954) 3) V.V. Dubilkin et al, Izv Akad Nauk SSR (1971), 1554 & CA 75, 98016 (1971)

Dinitrohexanes, $\text{C}_6\text{H}_{12}(\text{NO}_2)_2$; mw 176.20, N 15.90%. The following isomers are known:

1,1-Dinitrohexane, $(\text{O}_2\text{N})_2\text{CHC}_5\text{H}_{11}$; yel oil, bp 80.5° at 1 mm, d 1.091, RI 1.4432 at 25° (Ref 2), insol in w, sol in alc & eth. Prep'd by nitrating methylhexylketone or hexane

Refs: 1) Beil 1, 147 & <357> 2) L. Ershova et al, IzvAkadNauk, SSSR 943 (1959) & CA 54, 259 (1960)

1,2-Dinitrohexane, $\text{NO}_2\text{CH}_2\text{CH}(\text{NO}_2)\text{C}_4\text{H}_9$; liq. Prep'd by reacting 1-hexane with an equilibrium mixt of NO_2 & N_2O_4 to give 1,2-dinitrohexane & 1-nitro-2-hexanol nitrite

Refs: 1) Beil, not found 2) G.A. Bonetti et al, USP 3192248 (1965) & CA 63, 11361 (1965)

2,4-Dinitrohexane, $\text{CH}_3\text{CH}(\text{NO}_2)\text{CH}_2\text{CH}(\text{NO}_2)\text{C}_2\text{H}_5$; liq, bp $177-79^\circ$ at 0.5mm, d 1.100, RI 1.4482 at 25° (Ref 2)

Refs: 1) Beil 1, <357> 2) V.P. Tsybasov & V.F. Petrovich, IzvVysshikhUchebnZavedenii, Khim i KhimTechnol 5, 942 (1962) & CA 59, 3756 (1963)

3,4-Dinitrohexane. $\text{C}_2\text{H}_5\text{CH}(\text{NO}_2)\text{CH}(\text{NO}_2)\text{C}_2\text{H}_5$; pale yellow liq, bp $50-54^\circ$ at 0.3mm, RI 1.4512 at 25° , sol in chl. Prep'd by reacting 1-nitropropane in an alkaline chloroform mixt with an aq soln of Na-persulfate, Na-acetate & Ag-nitrate (Ref 2)

Refs: 1) Beil 1, <357> 2) A.H. Pagano & H. Shechter, JOrgChem 35 (2), 295 (1970) & CA 72, 78205 (1970)

Tetranitrohexanes, $\text{C}_6\text{H}_{10}\text{N}_4\text{O}_8$; mw 266.20, N 21.05%. Two isomers are known:

1,1,1,3-Tetranitrohexane, $\text{CH}_3(\text{CH}_2)_2\text{CH}(\text{NO}_2)\text{CH}_2\text{C}(\text{NO}_2)_3$; crystals (from hexane), mp $37.7-38^\circ$; was prep'd by addg 1,1,1-trinitro-3-aci-nitrohexane to a vigorously stirred soln of urea in MeOH (Refs 1 & 4)

3,3,4,4-Tetranitrohexane,

$C_2H_5C(NO_2)_2C(NO_2)_2C_2H_5$; wh waxy crysts, mp 106–07°; was prepd by treating 3,4-dinitrophenyl-3-en with liq N_2O_5 at 85° (Refs 2 & 3)

Refs: 1) Beil 1, <357> 2) Beil 1, <358>
3) C.E. Grabiell, JACS 77, 1293 (1955) & CA 50, 1571 (1956) 4) S.S. Novikov et al, BullAcad-Science(USSR) 1959, 1765 (Engl)

Hexanediol and Derivatives**1,6 Hexanediol or 1,6 hexamethyleneglycol.**

$CH_2OH(CH_2)_4CH_2OH$; mw 118.17; low melting needle-like solid or colorless liq, mp 42°, bp 250°, fl p266°F, d 0.953; sol in water & alc; sl sol in hot eth; low toxicity. Prepd by reduction or hydrogenation of adipic acid esters. Used as solvent and resin intermediate. It is the parent compd for the following derivs, none of which appears to be explosive

Refs: 1) Beil 1, 484 (251) [551] & [220]
2) Cond Chem Dict (8 Edit) (1971) p 443

Dinitrohexanediols, $(HO)_2C_6H_{10}(NO_2)_2$; mw 208.20, N 13.46%. The following isomers are known:

2,5-Dinitro-3,4-hexanediol.

$H_3CCH(NO_2)CH(OH)CH(OH)CH(NO_2)CH_3$; crysts, mp 111–112° (from EtOH/water), 163–165° (from EtOH) (Refs 2, 3 & 4). Prepd by treating glyoxal in alk soln with $EtNO_2$, neutralizing Na-salt with HOAc, & extracting with nitromethane (Ref 1); by adding $O_2N(CH_2)_4NO_2$ to aq NaOH and when salt form is complete treating with aq formald and HOAc (Ref 2 & 3)

Refs: 1) Beil, not found 2) H. Plaut, USP 2616923 (1952) & CA 49, P 11701 (1955)
3) H. Feuer & R. Miller; JOrgChem 26, 1348-57 (1961) & CA 56, 1334 (1961) 4) H. Feuer A.T. Nielsen & C.E. Colwell, Tetrahedron, 19, Suppl 1, 57-64 (1963) & CA 59, 11229 (1963).
5) E.S. Lipina, V.V. Perekalin, Ya. S. Bobovich, ZhObshchKhim 34(1), 3635-40 (1964) & CA 62, 9043 (1965)

5,5-Dinitro-1,2-hexanediol.

$H_2C(OH)CH(OH)C_2H_4C(NO_2)_2CH_3$; liq, RI 1.4804 at 25°, sol in CH_2Cl_2 . Prepd by adding MeOH soln of $CH_3C(NO_2)_2(CH_2)_2COCH_2OH$ to cold alk soln of $NaBH_4$ & acidifying with H_2SO_4 (Refs 2 & 3). Has anti-bacterial, fungicidal & anti-inflammatory props (Ref 4)

Refs: 1) Beil, not found 2) Aerojet-General Corp FP 1319705 & CA 59, P9791 (1963)
3) G.B. Linden, USP 3101378 (1956) & CA 60, P1589 K1964) 4) H. Gold, Nitro Compds Proc Intern Symp, Warsaw 1963, 449–61 & CA 64, 1184 (1966)

Tetranitrohexanediols, $(HO)_2C_6H_8(NO_2)_4$; mw 298.20, N 18.79%, OB to CO_2 –37.6%. The following isomers are known:

1,1,6,6-Tetranitro-2,5-hexanediol.

$(NO_2)_2CHCH(OH)CH_2CH_2CH(OH)CH(NO_2)_2$; brown liq; sol in CH_2Cl_2 . Prepd by suspending di-K salt of $Me(NO_2)_2$ in water and adding $(CH_2CHO)_2$ & then neutralizing with sulfuric acid. Used as an intermediate. It is exnl

Refs: 1) Beil, not found 2) H. Plaut, USP 2544103 (1951) & CA 45, 7587 (1951)

2,2,5,5-Tetranitro-1,6-hexanediol.

$OHCH_2C(NO_2)_2CH_2CH_2C(NO_2)_2CH_2OH$; crysts, mp 126–27° (recrystd from w); sol in Et_2O & w. Prepd by mixing MeOH soln of tetranitrobutane with formalin and adding small amount of NaOH; adding 1,4-dinitrobutane to aq NaOH & then adding formalin & finally an aq soln of $NaNO_2$ & $AgNO_3$. No expl props mentioned, but it is expl

Refs: 1) Beil, not found 2) H. Feuer et al, JOrg Chem 27, 3598 (1962) & CA 57, 14921 (1962)

2,5-Hexanedioldinitrite. $CH_3CH(ONO)CH_2CH_2CH(ONO)CH_3$; liq, bp 56° at 33mm, d 1.042, RI 1.3978 at 25°; insol in w. Prepd by treating aq $(CH_3CHOHCH_2)_2$ at 0° with aq $NaNO_2$ and then adding 6N HCl. The kinetics of its decompn were also studied

Refs: 1) Beil, not found 2) L.P. Kuhn et al JACS 78, 2719 (1956) & CA 50, 14506 (1956)

2,5-Hexanedioldinitrate, or 2,5 Dinitroxyhexane.

$CH_3CH(ONO_2)CH_2CH_2CH(ONO_2)CH_3$; mw 208.20, N 13.46%, OB to CO_2 –92.2%; crysts, mp 50.4°, vap press 0.98–1.33, 6.1–9.4 & 19–31 at 20, 30 & 40° resp, heat of fusion 13.2kcal/mole, heat of vaporization 13.0 kcal/mole. Prepd by nitration of 2,5 hexanediol. No expl props mentioned
Ref: 1) Beil, not found 2) M.D. Kemp et al, JPhysChem 61, 240 (1957) & CA 51, 8524 (1957)

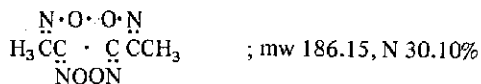
2,3,4,5-Hexanetetron-tetraoxime Diperoxide or Dimethyltetraacetone tetraoxime Diperoxide

OB to CO₂ -77.4%; crystals (from eth), mp 181°. Prepd by reacting (C₂N₂O₂)C(NO₂)CH₃I in ether with N₂O₄; or reacting the above oxime with 50% nitric acid and aq KMnO₄. No explosive props are mentioned

Refs: 1) Beil, not found 2) G. Ponzio & V. Bernardi, *Atti AccadSciTorino* **59**, 693 (1924) & *CA* **19**, 469 (1925) 3) G. Ruggeri, *Gazz chim ital* **54**, 72 (1924) & *CA* **19**, 2187 (1925) 4) Nothing more recent found in *CA*

Hexanetriol and Derivatives

1,2,6-Hexanetriol. OHCH₂CH(OH)(CH₂)₃CH₂OH; mw 134.20; colorless liq, fl p 32.8°, bp at 5mm 178°, flp 380°F, d 1.10, RI 1.476 at 20° (Ref 3); sol in w; low toxicity. Prepd by hydrogenation of 2-hydroxyadipic aldehyde over Raney Ni (Ref 2). Used as resin intermed, softener & solvent

Refs: 1) Beil, not found 2) V.I. Karzhev & B. Ya. Rabinovitch, *Neftekhimia* **3** (2) 267 (1963) & *CA* **59**, 6240 (1963) 3) H. Meister. *Ber* **98**, (9) 2862 (1965) & *CA* **63**, 13233 (1965)

1,2,6-Hexanetrioltrinitrate (HTTN). O₂NOCH₂CH(ONO₂)C₃H₆CH₂ONO₂; mw 269.20, N 15.61%, OB to CO₂ -50.5%; light tan liq melts below -51°, d 1.39, sl sol water, v sol eth, acet, non-hygroscopic. Obtained by mixed acid nitration of hexanetriol at 0°, separating HTTN, washing and stabilizing with NaHCO₃ soln. Proposed as a substitute for NG in dynamites

It has an impact sens of 76cm on B of M machine with 2 kg weight & will not explode in friction pendulum test. Its vacuum stability is 0.8 cc of gas in 40 hours at 100°

Refs: 1) Beil, not found 2) J.B. Bronstein Jr, *USP* 2683164 (1954) & *CA* **48**, 11062 (1954)

Hexanhexol. See *Dulcitol and Derivatives* in Vol 5, p D1567-R

Hexanites or Schiesswolle neuer Art. (in Ger) are cast charges of 60/40 TNT/Hexanitrodiphenylamine

Ref: Anon "Explosivstoffe" Wasag-Chemie AG, Essen, (1961) p 76

Hexanitate Dulcitol. See *Dulcitol Hexanitate* in Vol 5, p D1567-R

Hexanitroazobenzene. See under *Azobenzene* Vol 1, p A649

Hexanitrocarbanilide or *sym-Dipicrylurea*. See *N,N'*-Bis(2,4,6-trinitrophenyl)-urea in Vol 2, p B156-L

Hexanitrocompounds are described under corresponding parent substances

Hexanitrodiphenylamine. See under *Diphenylamine* in Vol 5, p D1434-R

Hexanitrodiphenylsulfide. See under *Diphenylsulfide* in Vol 5, p D1477-R

Hexanitrodiphenylsulfone. See under *Diphenylsulfone* in Vol 5, p D1480-L

Hexanitrodiphenyloxide. Same as *Hexanitrodiphenylether*, Vol 5, p D1453-R

2,4,6,2',4',6'-(Hexanitrodiphenyl)-ethylene-dinitramine or *N,N'*-Di(2,4,6-trinitrophenyl-nitramino)-ethane (Code named *Bitetryl*, *Ditetryl* or *Octyl*). See *1,2-Bis(2',4',6'-trinitro-nitranilino)-ethane* in Vol 2, p B131-R

Hexanitrodiphenyl Guanidine. See *N,N'*-Bis(2,4,6-trinitrophenyl)-guanidine in Vol 2, p B154-R

2,4,6,2',4',6'-Hexanitrodiphenylmethylamine. See under *Diphenylmethylamine* in Vol 5, p D1468-L

N,N'-Hexanitrodiphenylpropane-1,3-dinitramine. One of the names for *Methylene Ditetryl* described as *1,3-Bis(2',4',6'-trinitro-N-nitranilino)-propane* in Vol 2, p B133-L

N,N'-(Hexanitrodiphenyl)-propylene-1,3-dinitramine (Code named *Methylene Ditetryl*). See *1,3-Bis(2',4',6'-trinitro-N-nitranilino)-propane* in Vol 2, p B133-L

Hexanitrodiresorcin or **2,4,6,2',4',6'-Hexanitro-3,5,3',5'-tetrahydroxydiphenyl.** See *Hexanitrobiresorcinol* under *Biresorcinol and Derivatives* in Vol 2, p B127-L

Hexanitrodioresorcinol. See Hexanitrobiresorcinol under Biresorcinol and Derivatives in Vol 2, p B127-L

Hexanitrodulcitol. See under Dulcitol Hexanitate in Vol 5, p D1567-R

Hexanitroethane. See under ethane and derivatives in Vol 5, p E149-L

Hexanitrohydrazobenzene or N,N'-Dipicrylhydrazine. See Vol 5, p D1463-L

Hexanitrohydrocellulose. See under Hydrocellulose Nitrates in this Vol

Hexanitroinositol. See under Inositol and Derivatives in this Vol

Hexanitromethylphenylether or Hexanitro-4-methyldiphenyl ether. $(\text{O}_2\text{N})_3\text{C}_6\text{H}_2\text{OC}_6\text{H}(\text{CH}_3)(\text{NO}_2)_3$ (Note - The position of the NO_2 groups has not been established); mw 452.23, N 18.59%, OB to CO_2 -53.1%, mp 103.5°. Crystals (from hot alcohol); may be prep'd by boiling 4-nitro-4'-methyldiphenylether (or 4-nitro-2'-methyldiphenylether) with strong nitric acid for 45 minutes and then pouring the solution into a large amount of cold water. This separates a light yellow oil which turns into crystals that are very slightly sol in w; sol in bz, eth, acetic acid, carbondisulfide and hot alcohol; difficultly sol in cold alcohol. When ignited in the flame of a lamp it deflagrates

Recently the *3'-Methyl-2,2',4,4',6,6'-hexanitrodiphenyl Ether*, mp 141-42°, has been prep'd by the mixed acid nitration of the corresponding pentanitro diphenyl ether (Ref 4)
Refs: 1) Beil 6, 394 & (200) 2) A.N. Cook, JACS 25, 64 (1905) 3) A.N. Cook & F.N. Sherwood, JACS 37, 1836 (1915) 4) G. Adamska & K. Okon, Roczn Chem 42, (10), 1681 (1969) & CA 70, 37355 (1969)

3,3,5,5,7,7 Hexanitro-1,9-nonane Diisocyanate. mp $127 \pm 1^\circ$. Prep'd by heating at 80°
4,4,6,6,8,8 hexanitro-1,11-undecandioicazide (mp $84 \pm 1^\circ$) which in turn is made by treating the corresponding dibasic acid with sodium azide. The diisocyanate is claimed to

be useful in the prep of high energy polyurethane propellants

Ref: 1) Beil, not listed. 2) K. Klager USP 2978475 (1961) & CA 55, 19799 (1961)

Hexanitrooxanilide or N,N'-Dipicryloxamide. See under Oxamide

Hexanitrophenolanthrone. The name given in JCS 100(I), 656 (1911) for the comp'd listed in Vol 2, p B147-L as 10,10-Bis(4-hydroxyphenyl)-x,x,x,x,x-hexanitro-9-anthranone

Hexanitrosobenzene. See under Benzene and Derivatives in Vol 2, p B45-L

Hexanitrosorbitol. See Sorbitol Hexanitate under Sorbitol and Derivatives

Hexanitrosulfobenzide. Same as Hexanitrodiphenylsulfone, Vol 5, p D1480-L

Hexanols and Derivatives

Hexanols, $\text{C}_6\text{H}_{14}\text{O}$, mw 102.17. The following isomers are known:

1-Hexanol or n-Hexyl Alcohol,

$\text{H}_3\text{C}(\text{CH}_2)_4\text{CH}_2\text{OH}$; colorless liq, sp gr 0.822 (15/4°), fr p -51.6°, bp 157.5°, RI 1.4169 (25°)

2-Hexanol or Butylmethylcarbinol,

$\text{H}_3\text{CCHOHC}_4\text{H}_9$; colorless liq, sp gr 0.818 (16.8/4°), bp 140°, RI 1.4126 (Ref)

3-Hexanol, $\text{C}_2\text{H}_5\text{CHOHC}_4\text{H}_9$; colorless liq, sp gr 0.818 (20/4°), bp 135°

Ref: 1) Beil 1, 407-08, (202), [437-38] & {1660}

Dinitrohexanols, $\text{C}_6\text{H}_{12}\text{N}_2\text{O}_5$; mw 192.20, N 14.58%. The following isomers are known:

2,6-Dinitro-1-hexanol

$\text{OHCH}_2\text{CH}(\text{NO}_2)(\text{CH}_2)_3\text{CH}_2\text{NO}_2$; yel liq, bp decomp, RI 1.4745 at 20°; sol in CH_2Cl_2 . Prep'd by reacting 1,5 dinitropentane with aq NaOH then formalin (37% soln) and acetic acid

Refs: 1) Beil, not found 2) A.T. Nielsen, JOrgChem 27, 1993 (1962) & CA 57, 45569 (1962)

5,5 Dinitro-2-Hexanol. $\text{H}_3\text{CCH}(\text{OH})(\text{CH}_2)_2\text{C}(\text{NO}_2)_2\text{CH}_3$; yel liq, bp 104° at 0.6mm, RI 1.4636 at 20°, d 1.24; sol in eth. Prep'd by adding aq NaBH_4 to MeOH soln of $\text{CH}_3\text{CO}(\text{CH}_2)_2\text{CH}_3$ with the pH of

mixt constantly adjusted with H_2SO_4 at 3-4

Refs: 1) Beil, not found 2) H. Shechter et al, JACS **74**, 3664 (1952) & CA **47**, 5886 (1953)

1-Nitro-2-Hexyl Nitrate. $O_2NCH_2CH(ONO_2)(CH_2)_3CH_3$; prepd by first obtaining 1-nitro-2-hexylperoxyxynitrate by reacting 1-hexene in CCl_4 with Oxygen & N_2O_4 and then treating with NO_2 . It is used as a fuel additive & intermediate in preps of surfactants, insecticides, etc

Refs: 1) Beil, not found 2) D.R. Lachowicz & K.L. Kreuz USP 3282983 (1966) & CA **66**, 10577 (1967)

Hexanones and Derivatives

Hexanones, $C_6H_{12}O$; mw 100.16. The following isomers are known:

2-Hexanone or n-Butylmethyl Ketone,

$CH_3COC_4H_9$, colorless liq, sp gr 0.816 (15/4°), fr p -56.9°, bp 127.2°, fl p 95.8°F. Very toxic

Ref: Beil **1**, 689, (354), [745] & [2826]

3-Hexanone, $C_2H_5COCH_2C_2H_5$; colorless liq, sp gr 0.813 (21.8/4°), bp 123-24°

Ref: Beil **1**, 690, (354), [746] & [2830]

Dinitrohexanones, $C_6H_{10}N_2O_5$; mw 190.18, N 14.73%. The following isomers are known:

5,5-Dinitro-2-hexanone,

$H_3CCO(CH_2)_2C(NO_2)_2CH_3$; liq, sp gr 1.264, RI 1.4607 (20°), bp 110° at 1.3mm; sol in CH_2Cl_2 .

Prepd by adding dioxane solns of $CH_2(NO_2)_2$ & $PhCH_2NMe_3OH$ to $C_2H_5CH:CH_2$. After 65 hrs stirring mixt is poured into w & acidified and product extracted with CH_2Cl_2 . It is expl

Refs: 1) Beil, not found 2) H. Shechter & L. Zeldin, JACS **73**, 1276 (1951) & CA **45**, 9459 (1951)

4,4-Dinitro-3-hexanone,

$H_5C_2COC(NO_2)_2C_2H_5$; liq, bp 69-71° at 1 mm, RI 1.4548. Prepd by reacting EtC:CEt with N_2O_4 in dry Et_2O and distilling the resulting oil. It is expl

Refs: 1) Beil, not found 2) J.P. Freeman & W.D. Emmons, JACS **70**, 1712 (1957)

HEXAZADIENES (Hexazdien in German).

Hexazadienes are derivatives of $NH:N.NH.NH$.

$N:NH$ Some of them are explosive, for instance:

1,6-Bis-[tetrazolinylidene-(5)]-hexazadiene or **1,6-Di-[tetrazolyl-(5)-hexazadiene]** (Bisdiazotetrazolhydrazide old German),

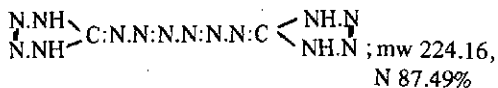

(of all known organic compounds, this is the richest in nitrogen), mp (explodes at about 90°). Leaflets, was prepd by Hofmann et al from 5-diazotetrazol hydrochloride, hydrazine hydrochloride and sodium acetate at a very low temperature

According to Karrer (Ref 4), it may be prepd by diazotizing 5-aminotetrazole and coupling the resulting compound with hydrazine

Stable at room temp; powerful explosive. If some dry crystals are scattered loosely on a piece of cardboard and one of the crystals touched with a flame or heated object (rod etc), the material will detonate with such brisance that each crystal will puncture the cardboard
Refs: 1) Beil **26**, (123-24) 2) K.A. Hofmann & H. Hock, Ber **44**, 2953 (1911) 3) F.R. Benson, Chem Revs **41**, 9 (1947) 4) Karrer (1950. ed) p 803 (under Tetrazole)

Hexazidocuprate-Lithium Salt. $Li_4[Cu(N_3)_6]$; mw 343.49, N 73.42%; crysts with $3H_2O$ which is lost above 120°. The anhydrous compound explodes at 224.5°. Prepd by dissolving Cupric Azide in aq or alc soln of Lithium Azide
Refs: 1) Gmelin, Syst No 60, Teil B, 150 (1958) 2) M. Straumanis & A. Cirulis, ZAnorgChem **252**, 9 (1943) & CA **38**, 3563 (1944)

Hexazidostannate-Sodium Salt. $Na_2Sn(N_3)_6$, probably $Sn(N_3)_4 \cdot 2NaN_3$; mw 416.85, N 60.50% white solid, sl sol in eth or benz. Prepd by heating a tetrahydrofuran soln of $SnCl_4$ & NaN_3 . Hydrolyzes in moist air. Explodes on boiling over an open flame

Refs: 1) Gmelin, Syst No 46, Teil 61, 145-46 (1972) 2) E. Wiberg & H. Michard, ZNaturforsch **9b**, 500 (1954) & CA **49**, 768 (1955)

Hexazobenzene. See Diazidobenzene in Vol 2, p B42-R

Hexenes and Derivatives

Hexenes or Hexylenes, C_6H_{12} ; mw 84.18. Six isomers are described in Beil. Three of them: 1-, 2-, and 3- are described below together with their nitrated derivs

1-Hexene or Hexylene, C_6H_{10} :CH; mw 84.16, colorless liq, fr p -139.8° , bp 63.6° , fl p $-15^\circ F$, d 0.673, RI 1.3876 at 20° ; insol in w; sol in alc. Prepd by reaction of PrMgBr & allylbromide.

Highly flammable and moderately toxic

Refs: 1) Beil 1, 215, (89), [191], {800} & <828> 2) CondChemDict, 8th Edit (1971), p 444

1-Nitro-1-hexene. $HC(NO_2):CHC_4H_9$; mw 129.18, N 10.84%; liq, bp $54-55^\circ$ at 1.5 mm, RI at 25° 1.4581. Prepd by refluxing $BuCH(OAc)CH_2NO_2$ in benzene containing Na-carbonate

Refs: 1) Beil 1, <833> 2) N.L. Drake & A.B. Ross, JOrgChem 23, 717 (1958) & CA 53, 12215 (1959) 3) F.I. Carroll et al, Ibid 28, 1236 (1963) & CA 58, 12408 (1963)

2-Nitro-1-hexene (called 2-Nitro-hexen(1) in Ger), $H_2C:C(NO_2)C_4H_9$; liq, bp $81-2^\circ$ at 50mm (Ref 1), RI at 25° 1.4462. Prepd by treating Et_2NH aq with aq HCHO (37%) & then with $C_5H_{11}NO_2$ to give 2-nitrohexyldiethylamine whose HCl salt is pyrolyzed to yield the desired nitroalkene (Ref 2); also by distilling under reduced pressure 2-nitro-1-hexanol & phthallic anhydride (Ref 3)

Refs: 1) Beil 1, {804} 2) A.F. McKay et al, JACS 70, 430 (1948) & CA 42, 2228 (1948) 3) M. Masaki & M. Ohta, Bull Chem Soc Japan 35, 1808 (1962) & CA 59, 424 (1963)

2-Hexene, β -Hexylene or 1-Methyl 2-propyl ethylene. $CH_3CH:CH(CH_2)_2CH_3$; mw 84.16; colorless liq, frp -136° , bp 68° , flp $-5^\circ F$, d 0.686 at 20° , RI 1.3948, insol in w;

sol in alc or dil H_2SO_4 ; low toxicity. Prepd by reacting 3-iodohexane with sodamide; by hydrogenation of n-heptyl alcohol over finely divided nickel. Used as chemical intermediate

Refs: 1) Beil 1, (89), [192], {804} & <833> 2) CondChemDict (1971), p 444

2-Nitro-2-hexene (Called 2-nitro-hexen(2) in Ger). $H_3CC(NO_2):CHC_3H_7$; mw 129.18, N 10.84%; yellow liq, bp 82.3° at 10mm, d 0.9824, n_D at 25° 1.4572 (Ref 2); sol in benz (Ref 4).

It is an eye irritant and is moderately toxic (Ref 5). Prepd by refluxing $MeCH(NO_2)CH(OAc)$ Pr in dry benzene containing Na-carbonate (Refs 2 & 4); by heating 2-nitrohexanol with

phthallic anhydride (Ref 3)

Refs: 1) Beil 1, {806} & <836> 2) H.B. Hass et al, JOrgChem 15, 8 (1950) & CA 44, 4412 (1950) 3) T.M. Khannanov et al, Trudy Kazan-

Khim Tekhnol Inst 26, 59 (1959) & CA 54, 24345 (1961) 4) F.I. Carroll et al, JOrgChem 28, 1236 (1963) & CA 58, 12408 (1963)

5) W.D. Deichman et al, Ind Med Surg 34 (10), 800 (1965) & CA 64, 4153 (1966)

3-Nitro-2-hexene. $H_3CCH:C(NO_2)C_3H_7$; liq, bp 70.9° at 10mm, d 0.9797, RI at 25° 1.4545 (Ref 3), sol in benz. Prepd by refluxing $C_3H_7CH(NO_2)CH(OAc)CH_3$ with dry benz containing Na-carbonate (Ref 2). Toxicity about same as 2-nitro-hexene

Refs: 1) Beil 1, <836> 2) Same as 2 above 3) K.F. Lampe et al, JChemEngData 7 (1) 85 (1962) & CA 57, 8414 (1962) 4) Same as 5 above

4-Nitro-2 hexene. $H_3CCH:CHCH(NO_2)C_2H_5$; mw 129.1, N 10.8%; yellow-green liq, bp 72° at 10mm, d 0.9833, RI at 25° 1.4572, sol in benz. Prepd by refluxing $CH_3CH(OAc)CH_2CH(NO_2)C_2H_5$ in dry benzene containing Na-carbonate

Refs: 1) Beil, not found 2) same as 2 above
5,5 Dinitro-2-hexene. $H_3CCH:CHCH_2C(NO_2)_2CH_3$; mw 174.18, N 16.08%; liq, bp $60-70^\circ$ at 1-2mm, RI at 25° 1.4555, sol in hexane. Prepd by heating 5,5-dinitro-2-hexanol with a few drops of concd sulfuric acid

Refs: 1) Beil, not found 2) G.B. Linden, Brit P 936087. (1963) & CA 61, 6920 (1964)

3-Hexene, s-Diethylethylene or γ -Hexylene.

$C_2H_5CH:CHC_2H_5$; mw 84.16 liq, bp 70° , d 0.693 at 20° . Prepd by reacting 3,4-dibromohexane with Zn dust; or by partial hydrogenation of 3-hexyne over Raney nickel

Refs: 1) Beil 1, [192], {806} & <837> 2) CondChemDict, 1971, p 444

3-Nitro-3-hexene (called 3-Nitro-hexen(3) in Ger). $C_2H_5C(NO_2):CHC_2H_5$; mw 129.18, N 10.84%; yellow liq, bp 70.6° at 10mm, d 0.9736, RI 1.4510 at 25° (Ref 2); sol in benzene. Prepd by refluxing $C_2H_5CH(NO_2)CH(OAc)C_2H_5$ in dry benzene containing Na-carbonate (Ref 1)

Refs: 1) Beil 1, {808} & <840> 2) K.F. Lampe et al, JChemEngData 7, (1), 85 (1962) & CA 57, 8414 (1962)

3,4 Dinitro-3 hexene (called 3,4 Dinitro-hexen(3) in Ger). $C_2H_5C(NO_2):C(NO_2)C_2H_5$; mw 174.18,

N16.09%; light yellow needles, mp 29-32°, bp 53-5° at 1mm, RI at 25° 1.4640 (Ref 3). IR spectra in Ref 2. Prepd. by reacting EtC:CEt with N₂O₄ in ether (Ref 3). Reacting 1-chloro-1-nitropropane with aq KOH and then acidifying to a pH of ≈9. The residue after separation and washing is distilled, under vac & nitrogen atmos to prevent explosion, to get additional product (Ref 4)

Refs: 1) Beil 1, {808} & <840> 2) J.F. Brown, JACS 77, 6341 (1955) & CA 50, 2297 (1956) 3) J.P. Freeman & W.D. Emmons, JACS 79, 1712 (1957) & CA 51, 11267 (1957) 4) Org Synth 4, 372 (1957)

Trinitro, C₆H₉N₃O₆, *Tetrinitro*, C₆H₈N₄O₈, and *Pentanitro*, C₅H₇N₅O₁₀, derivs of Hexene were not found in Beil

1,1,1,6,6,6-Hexanitro-3-hexene. (NO₂)₃CCH₂CH:CHCH₂C(NO₂)₃; mw 354.18, N 23.73%, OB to CO₂ -13.5%; crystals, mp 128°, d 1.77.

Prepd from 1,4 Dibromo-2-butene and Ag-nitroform. It is an explosive of about the same sensitivity as PETN

Refs: 1) Beil, not found 2) D.V. Sickman & W.F. Sager, NAVORD Rept 486, (1954) 3) Not found in CA thru 1971

Hexit. Same as Hexanitrodiphenylamine, Vol 5, p D1434-R

Hexite. Same as Hexanitrodiphenylamine, Vol 5, p D1434-R

Hexo. One of the Ger abbreviation for Hexogen (RDX). See Vol 5, p 611-L

Hexo (S-15 and S-22). Ger "Substitute Explosives" (Ersatz-sprengstoffe), contg Hexogen. See Vol 5, p E122, Table E15

Hexocire (Fr). Mixture of RDX and Wax

Hexogen (H). Ger for Cyclonite or RDX. Also known as W-Salz, E-Salz, K-Salz, SH-Salz and KA-Salz, depending on the method of prepn

Ger WWII methods of prepn are described in Vol 3 of Encycl, pp C613-R to C614-R, under CYCLOTRIMETHYLENE TRINITRAMINE

Hexolit. Same as *Nipolit* (See below), but with Hexogen (RDX) in lieu of Pentrit (PETN)

Note: *Nipolit* developed during WWII by the

Deutsche Spengchemie GmbH was a type of NC-DEGDN-PETN proplnt or expl. Two compns are listed in PATR 2510, (1958), p Ger 117-R:

a) *Nipolit* in tubes: NC (12.6%N) 34.1, DEGDN 35.0, PETN (unwaxed) 35.0, stabilizer 0.75, MgO 0.05, graphite 0.1%, calorific value 1300 cal/g

b) *Nipolit* in sticks: NC 29.1, DEGDN 20.0, PETN 50.0, stabilizer 0.75, MgO 0.05 and graphite 0.1% (Ref 1)

Berkovic (Ref 2) states that Hexolit is composed of RDX 90 & TNT 10 and claims that it has low impact sens

Refs: 1) Dr. H. Walter, formerly of PicArsn; private communication (1960) 2) M. Berkovic, Explosivst 12, 207 (1964)

Hexolites (Fr). Mixtures of RDX (hexogene in Fr) and TNT (tolite in Fr). Same as Cyclotols

Hexone T4. Same as Cyclonite or RDX, Vol 3, C611-R

Hexonite (Swiss). Hexonites are plastic explosives, proposed by Stettbacher, consisting of RDX and NG, with or without Collodion Cotton. For instance:

a) RDX 20-50 & NG 80-50% b) RDX 50, NG 46 & Collodion Cotton 4%

Comparative brisance tests with 50/50 Hexonit and 50/50 Pentrit by the iron plate test showed that Hexonit is not as effective as Pentrit (Ref 1). It is also claimed that RDX in Hexonit does not form such a homogeneous mass with NG and NC as does PETN in Pentrit (Ref 2), and it tends to exude. NG was used by the Germans for loading torpedo heads

Refs: 1) A. Stettbacher, Nitrocellulose 4, 224 (1933) 2) A. Stettbacher, Pólvoras y Explosivos, G. Gili, Buenos Aires (1952) p 111

Hexonyl. Same as Hexanitrodiphenylamine, Vol 5, p D1434-R

Hexoplast 75. A plastic explosive, developed during WW II at the Krümmel Factory of Dynamit AG. It contained RDX 75, NC 1.2 to 1.4, liquid DNT 20.0 and TNT 3.8 to 3.6%. This mixture was prepd by heating the required amount of RDX to 90° in a Werner-Pfleiderer mixer, and blending it with a small amount of

NC. This was followed by the addition of a DNT-TNT mixture and further blending. By using this order of addition, lumping was avoided

The mixture was put out in cylinders about 220 mm long by 28 mm in diameter. Due to difficulty with direct cap initiation, a booster was provided. It consisted of compressed, phlegmatized PETN pellets about 40 mm long by 21 mm diam and equipped with a detonator well 20 mm deep

Note: This explosive was developed as a substitute for the plastic explosive, which used RDX plus American vaseline, because the latter component was no longer available in Germany. This vaseline, called "long fibrous" by Meyer, had much greater adherence than vaselines manufactured in other countries

Refs: 1) O.W. Stickland, *General Summary of Explosive Plants*, PB Rept 925, (1945) Appendix 7 (R. Meyer, Development Work on Explosives at Krummel) 2) PATR 2510, (1958), p Ger 90

Hexose, Pentanintrate. See Glucose Pentanintrate in Vol 6

Hexotol, which corresponds to the US & Brit *Cyclotol*, is a Swedish expl mixture usually containing 60% Hexogen (RDX) & 40% Tol (TNT). It has been manufd by AB Bofors-Nobelkrut in the form of granules. It corresponds to US *Composition B-2* which is described in Vol 3, Table on p C479. When 1% of synthetic wax is added to 60/40 mixture, the expl becomes *Composition B*. Hexotol has been used in Sweden for cast-loading shells at a density of 1.65-1.70. It is almost as insensitive to impact as TNT, but much more sensitive to initiation. Its deton velocity is 7800m/s, its fragmentation power is higher than that of TNT and it is as stable as RDX in the vacuum stability test

At Bofors, Hexotol is examined for appearance, composition, insol matter in acetone- CCl_4 , acidity, expln temp, viscosity and moisture
Ref: Anon, "Analytical Methods for Powders and Explosives," AB Bofors-Nobelkrut, Bofors, Sweden (1960), pp 201-203

Hexotonal. A Swedish expl mixture of Hexogen (RDX), TNT, and finely divided Al. Small amounts of desensitizer (wax), and in some

formulations carbon black, are added. Examples of comps: a) RDX/TNT/Al/Wax-40/44/15/1 or 40/40/15/5; b) RDX/TNT/Al-30/50/20, plus 1% wax & 1.5% carbon black. Hexotonal is usually prepd starting from Hexotol 60/40 or 50/50

Hexotonal has been manufd by AB Bofors for use as a cast filling at d 1.68-1.74. Its sensitivity to impact and friction is moderated by an addn of wax, its sensitivity to initiation is comparable to that of Hexotol, but bursting effect and fragmentation power are higher (Ref 3, p 203)

The following tests are described in Ref 2, pp 203-04: a) Content of RDX, plus Al b) Content of Al c) Content of desensitizer plus Al d) Content of desensitizer e) Content of TNT f) Acidity g) Explosion temperature (as described on pp 60-62 of Ref 2), and h) Moisture content

Accdg to Ref 1, Hexotonol consisting of RDX/TNT/Al-40/45/15 was used in 40mm shells

Ref: 1) Anon, "Ammunition for 40mm Automatic Gun L/70 MV 1000 m/sec," Sweden, (Nov 1953) 2) AB Bofors, same as Ref under Hexotol, pp 203-204

HEXYL. See Hexanitrodiphenylamine under Diphenylamine in Vol 5, p D1434-R

Hexylamines. See Aminohexanes in Vol 1, p A 215-R

Hexylaniline-2,4,6-Trinitro. $(\text{NO}_2)_3\text{C}_6\text{H}_2\text{NHCH}_2\text{C}_5\text{H}_{11}$; mw 312.32, N 17.94%, OB to CO_2 -133.2%; yellow plates (from CS_2) mp 70-70.5°; sl sol in eth or ligroin; sol in alc or benz; v sol in chl. Prepd from Picrylchloride & hexylamine in alc soln

Refs: 1) Beil 12, 764 2) E.V. Behrens, Rec 14, 38 (1895)

Hexylene Ozonide. $\text{C}_6\text{H}_{12}\text{O}_3$; mw 132.18; mobile oil, bp 60° at 12mm, d 0.994 at 23°, n_D 1.4059 at 25°. Sl sol in water with slow decomposition; sl sol in pet eth. Explodes if heated strongly above 60°. Prepd by reacting hexylene (in hexane or EtCl_2) with 15% ozone mixture
Refs: 1) Beil 1, (90) 2) C. Harries & K. Haeffner, Annalen 374, 331 (1910)

Hexylnitrate. $C_5H_9CH_2ONO_2$; mw 145.18, N 9.65%; liq, bp 46° at 1mm, d 0.9745. RI 1.481 at 25° , sol in eth & $EtCl_2$ (Ref 2). Prepd by reacting hexyliodide with silvernitrate in dry MeCN (Ref 3), or directly with 98% nitric acid (Ref 5); addition of N_2O_4 in $EtCl_2$ to hexanol (Ref 4)

Refs: 1) Beil 1, {1657} 2) L.M. Soffer et al, JACS 74, 5301 (1952) & CA 48, 343 (1954) 3) A.F. Ferris et al, JACS 75, 4078 (1953) & CA 49, 8158 (1955) 4) E.H. White & W.R. Feldman, JACS 79, 5832 (1957) & CA 52, 4469 (1958) 5) N.V. Svetlakov et al, Zh Org Khim 4, (11), 1893 (1968) & CA 70, 28327 (1969)

Hexylnitrite. $C_5H_9CH_2ONO$; mw 129.18, N 10.84%; liq, bp 50° at 48mm (Ref 2), 64° at 76mm; RI 1.399 at 20° (Ref 3). Prepd by heating $C_6H_{13}NO_2$ with $HCONMe_2$ & $NaNO_2$ (Ref 4); $C_6H_{13}Br$ + $HCONMe_2$ + $NaNO_2$ (Ref 5)

Refs: 1) Beil 1, 407 & {1657} 2) L.M. Soffer et al, JACS 74, 5301 (1952) & CA 48, 3243 (1954) 3) N. Kornblum et al, JACS 76, 3209 (1954) & CA 49, 8785 (1955) 4) N. Kornblum et al, JACS 78, 1501 (1956) & CA 50, 14505 (1956) 5) Ibid, 1497 (1956) & CA 50, 14504 (1956)

HEXYLS. Designation for 2,4,6-Trinitro-tris (alkylnitramino) benzenes, to be described under Nitramines

3-Hexyne and Derivatives

3-Hexyne. *3-Hexine or Diethylacetylene.*

$C_2H_5C:CC_2H_5$; mw 82.14; colorless liq, d 0.726 at 25° , refr index 1.4112; ins in water; v sol in alc or eth. Prepd by reacting 3,4-dibromo-3-hexene with Zn dust in boiling alc
Ref: Beil 1, [229] & {980}

No azido or nitro derivatives of 3-hexyne were found in Beil or CA. However, US Rubber Co & Navord reports describe:

1,1,1,6,6,6-Hexanitro-3-Hexyne. $(NO_2)_3CCH_2C:CC_2(NO_2)_3$; mw 352.16, N 23.87%. OB to CO_2 -9.1%; crystals, mp $129-130^{\circ}$, d 1.73. Prepd from 1,4-dibromo-2-butyne and Ag-nitroform. It has about the same explosive sensitivity and power as PETN. Its hot bar ignition temp is 205°

Refs: 1) Beil, not found 2) D.V. Sickman & W.F. Sager, NAVORD Rept 486, (1954) 3) J.C. Conly et al, US Rubber Co Quart Prog Repts on Contr NOrd 10129 (Nov 1952-Feb 1954)

Heyrovsky, Jaroslav (1890-1967) received the 1959 Nobel Prize in Chemistry for his discovery of polarography and for his role in the development of this technique which has become such an important tool in electrochemistry, analytical chemistry and many other areas of science and technology. He was for many years a professor of physical chemistry at the Charles University of Prague. When the Prague Polarographic Institute was founded in 1950, Heyrowski became its first director. Obituary notices for Prof Heyrowski appeared in many scientific journals attesting to his widespread recognition and esteem

Refs: 1) Anon, C&EN 45, 16 & 83 (1967) & CA 67, 17 (1967) 2) P. Zuman, JElectroanal Chem 15, 4 (1967) & CA 67, 96692 (1967) 3) G.F. Reynolds, JPolarogrSoc 13, 2 & 50-52 (1967) & CA 68, 26800 (1968) 4) J.A.V. Butler & P. Zuman, BiogrMemFellowsRoySoc 13, 167-91 (1967) & CA 68, 46098 (1968)

Hidrolitas. (Span) Explosives contg either PETN or RDX, paraffin and moist NH_4NO_3 . They are less sensitive to impact than either PETN or RDX, but are less powerful

Ref: Vivas, Feigenspan & Ladreda 2, (1946), p 288

High-Blast Explosive Filler. A MAX-2 composition consisting of aluminum 62, Composition A-4 38 & graphite (added) 1.5% gave superior positive impulse output in 37mm shell. Positive impulse was determined by using piezoelectric gages. Max damage occurs if the expl detonates immediately after the shell fully penetrates the skin of an aircraft

Ref: S. D. Stein, PATR 2523 (May 1958)

High-Blast Metal Oxygen Expls. Patented expls especially designed for aircraft destruction. They achieve enhanced blast effects through metal-O reactions and are claimed to be less affected by altitude than other HES. The composition contains: 54(50/50 Al/Mg), 36 AP, 4 TNT & 6% RDX or 54 (50/50 Al/Mg), 28 AN, 10 Tetryl & 8% TNT

Ref: S. J. Porter USP 2,992,086 (1961) & CA 55, 26447 (1961)

High Capacity (HC) Bombs. These British bombs used for general bombardment purposes are described in Ref

Ref: Dept of Army Tech Manual TM9-1985-1, "British Explosive Ordnance," (July 1952), pp 33-42 (Conf)

High Density Explosives. Explosives of high density are prepd by heating AN with freezing point depressants such as urea to effect only partial liquefaction of AN and adding to the mixture Ca-Si, Fe-Si, Al, or aromatic nitrocompounds

Ref: C. A. Woodbury & P. G. Wrightsman, USP 2,063,572 (1936), CA 31, 865 (1937)

High Energy Fuels. See under Exotic Fuels in Vol 6, p E350-L

High Explosives (HE). A high explosive is a substance that undergoes extremely rapid chemical reaction, when properly initiated, to produce gaseous products at high temperature and pressure. These products are then capable of doing useful work as they expand. It has been customary to divide HE into two categories: *primary* explosives and *secondary* explosives. This distinction is more in kind than in degree. Small quantities of primary or initiating explosives usually detonate when exposed to flames or high temperatures while secondary explosives usually burn or deflagrate under these conditions. However under slightly altered conditions primary explosives can be made to deflagrate and secondary explosives can be made to detonate. Examples of primary explosives are: Lead Azide, Mercury Fulminate, DDNP, etc. Examples of secondary explosives are: PETN, RDX, HMX, Tetryl, TNT, as single HE compns and Comp B, Comp C, PBX 9404, Dynamite ANFO (Ammonium Nitrate/Fuel Oil) as HE mixtures

It has also been traditional to distinguish HE from "low" or propellant explosives. Here again the distinction is not clear-cut. Although a "low" explosive such as *Black Powder* probably cannot detonate, most smokeless powders can. Conversely, most secondary explosives can be made to deflagrate. The main

difference between detonation and deflagration lies in the mode of propagation. Deflagration propagates via heat transfer such as conduction or radiation, while detonation propagates via a shock wave mechanism. As already stated both modes of action—detonation or deflagration are possible in most explosives

The above classifications are not strictly applicable to the *sensitivity* of an explosive. Although it is true that most primary explosives are more "sensitive" than most secondary explosives, certain low explosives, eg *Black Powder*, are more "sensitive" than many secondary or even primary explosives

See also DETONATION, EXPLOSION AND EXPLOSIVES Introduction and Definitions in Vol 4, p D217-L and also History of Explosives and Related Items in this Vol

Written by J. ROTH

High Explosive Projectile (Shell): The HE projectile is one in which the percentage of filler to total weight is as high as possible, consistent with other requirements, such as good fragmentation or demolition. The projectile consists of the shell proper and the fuze. The body of the shell is generally in the shape of a steel cylinder, having a tapered portion near the nose ("ogive"). Behind the ogive there is a smoothly machined section called "bourelet", the diameter of which is a few thousandths of an inch less than the diameter across the space between grooves of the bore (lands) of the gun barrel. The bourrelet rides on the lands and supports the forward portion of the projectile as it travels through the bore. In the rear of the body of the shell there is a "rotating band" usually made of gilding metal. This band acts as an after support of the shell and at the same time imparts rotation to the projectile because its diameter is somewhat larger than that across the lands and therefore becomes engaged as the projectile travels through the bore. Due to the tight fit in the bore, the band acts as a gas seal preventing the hot propellant gas from passing between the walls of the shell and the gun, so that the full expansion of gas is utilized to do the useful work of imparting projectile motion. A tapered section to the rear of the rotating band is called the "boat-tail", the purpose of which is to increase the stability of the shell during flight.

In order to prevent any hot gas from contacting the explosive charge (in the event that any porosity exists in the shell base) a thin steel disc is welded or brazed to the shell base ("base cover"). The shell is filled with high explosive (TNT, Amatol, Pentolite etc), leaving a cylindrical cavity at the upper part for a booster charge. The neck of the shell is threaded inside so that the fuze (including the booster) can be screwed on. The outer edge of the fuze is pointed and both the fuze and ogive meet to form a smooth contour

The HE shell may be designed primarily for *fragmentation* effect, obtained through dispersion of the fragments at high velocity, or for demolition effect produced by the *blast* of the HE, or a combination of these effects

The fragmentation shell has thicker walls than the demolition shell. The HE bursting charge is larger for the demolition than for the fragmentation shell

Refs: 1) Hayes (1938) p 562 2) Ohart (1946) pp 86, 98-99, 118 & 160 3) Anon, Engineering Design Handbook, Ammunition Series, Sec 4, "Design for Projection", **AMCP 706-247**, pp 4-117ff (July 1964) 4) Anon, "Artillery Ammunition", Dept of Army Tech Manual **TM9-1300-203** (April 1967)

High Explosives, Detection as Π Complexes. We quote from a very interesting paper by Parihar, Sharma & Verma (Ref 8) about a novel method of detecting explosives.

"A rapid and convenient procedure for the detection of explosives as Π complexes with aromatic amines is described. The method could be of immense value in places where normal laboratory facilities are not available

Recently nitroaromatic compounds have been employed as Π acceptors in the study of the charge-transfer complexes of a variety of organic compounds. During such investigations several chromatographic techniques were used. For example charge-transfer was found to be effective during the investigations of substituted anilines 2,4,7-Trinitrofluorenone systems in Gas Chromatography (GC) [1]. GC was helpful in the separation of aromatic compounds on columns containing 2,4-Dinitrochlorobenzene (DNCB) [2], and for olefins on 1,3,5-Trinitrobenzene (s-TNB) [3] impregnated columns. Picric acid [4] and other nitro aromatic compounds [5] have been

used as complexing agents for the separation of aromatic compounds by employing Thin Layer Chromatographic (TLC) technique

Nitro compounds form charge-transfer complexes with aromatic donors due to polarization of the nitro group as in I and II. According to Mulliken [6, 7] these Π complexes involve hybrid structures with only a dative and no bond. It has been more recently suggested [8] that in the for-

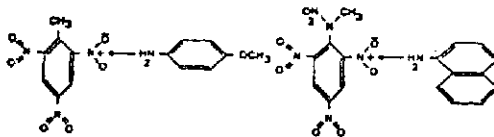

mation of 1:1 Π -complexes of m-Dinitrobenzene (m-DNB) with different aminobenzoic acids only one nitrogroup takes part

Explosives like s-Trinitrotoluene (s-TNT), s-TNB, Tetryl etc being Π acceptors make charge-transfer complexes with aromatic amines. Only in a few cases the Π complexes have been obtained in the crystalline state. In large number of cases these complexes are very unstable and cannot be isolated for the identification of the parent compound. The very labile physical linkages between the Π acceptor and the Π donor molecules are responsible for their break down. Solvent forces, steric hindrance due to groups, temperature etc weaken the charge-transfer linkages. Particularly during the study of such complexes by chromatographic techniques the absorption forces have a powerful dominating effect

When explosives are found singly or as mixtures there is a problem of their rapid identification. It is particularly significant in field areas where normal laboratory facilities are not available and unknown explosives have to be quickly characterized. Though the Π complexes of nitroaromatic compounds with hydrocarbons have been studied by TLC [5], yet suffer from the disadvantage of their colorless nature and difficulty of location on the chromatoplates

The present paper describes a simple and convenient procedure for the identification of explosives viz: Picramide; Hexyl; 2,4-Dinitrophenetole (DNP); Tetryl; s-TNT; s-TNB; 2,4,6-Trinitroanisole (TNA); 2,4-Dinitroanisole (DNA); 2,4,6-Trinitrophenetole (TNP); DNCB; m-DNB and Picryl Chloride (PC) in ordnance stores as charge-transfer complexes with amines utilizing TLC

technique. The resolved Π complexes being highly colored could be easily located from their R_f values. Thus by running the unknown samples along with the known compounds or alternatively from the known data of their resolutions as complexes with different aromatic amines, they could be readily detected up to 2-4y"

Note: The term R_f values refers to a relative rate of movement of the test sample through the chromatographic column

The authors summarize their findings as follows:

"The resolutions of the Π complexes was found to be governed by three factors (i) adsorbent, (ii) nature of the Π donor (here aromatic amine), and (iii) irrigating solvent. In general the migrations of the explosives were in relation to the effect of electron attracting or repelling groups present in them

On diphenylamine treated silica gel plates DNA moved less than DNP; similarly TNA had lower R_f than TNP. This is due to more electron repelling nature of the ethoxyl group compared to methoxyl. DNCB migrated higher than s-TNB, due to less electron affinity of chloro than nitro group. Similarly s-TNT had higher migration than s-TNB owing to electron repelling nature of CH_3 . s-TNB had lower R_f than m-DNB due to the presence of a third nitro group. Hexyl was most strongly bound compared to other polynitroamines ie Tetryl and Picramide

The relative role of the adsorbents was found to be interesting. For example on employing the same amine diethylaniline (DEA) as Π complexing agent and same solvent system monochlorobenzene (MCB) -ethylene dichloride (EDC)/9 : 1, DNA gave higher R_f than TNA on alumina in comparison to magnesium silicate plates. On alumina Π complexes of TNA, TNP and PC produced tailings. Magnesium silicate gave excellent resolutions but required more irrigation time than other adsorbents

The nature of the aromatic amine to form Π complexes was important. On silica gel G plates and MCB-EDC as solvent PC-anisidine complex had lower migrations than PC-DPA or PC-DEA complexes

The TNA-anisidine, TNP-anisidine complexes had lower migrations than DNA-anisidine and DNP-anisidine complexes. This observation was opposite to the resolutions of the complexes of these explosives with DPA and DEA

It was seen that irrigating solvent had pronounced effect on the relative mobilities of the Π complexes eg the R_f values of Tetryl and Picramide were reversed with petroleum ether-ethyl acetate (9:1) compared to MCB-EDC system"

Their data in tabular form follows:

R_f Values for Various Explosives

Names of the Explosives	Adsorbents Solvents	π -Complexes with Diphenylamine					
		Silica gel G		Magnesium Silicate		Alumina	
		Mono-chloro-benzene: Ethylene dichloride (9:1)	Petrol ether: Ethyl acetate (9:1)	Mono-chloro-benzene: Ethylene dichloride (9:1)	Carbon tetra-chloride	Mono-chloro-benzene: Ethylene dichloride (9:1)	Petrol ether: Ethyl acetate (9:1)
Picramide		.31	.09	.22	.04	.40	.34
Tetryl		.32	.05	.30	.06	.37	.28
Hexyl		.00	.00	.06	.00	.00	.00
s-Trinitrotoluene		.55	.34	.63	.29	.63	.67
s-Trinitrobenzene		.49	.24	.42	.11	.53	.61
1,3-Dinitrobenzene		.54	.28	.59	.41	.64	.72
Picryl chloride		.62	.30	.67	.36	.62	.62
2,4-Dinitrochlorobenzene		.66	.40	.70	.61	.65	.68
2,4,6-Trinitrophenetole		.52	.29	.60	.27	.29	.60
2,4-Dinitrophenetole		.39	.12	.39	.17	.51	.33
2,4,6,-Trinitroanisole		.48	.23	.54	.34	.26	.44
2,4-Dinitroanisole		.35	.09	.31	.21	.46	.37

and for two other solvents the R_f values for the same explosives arranged in the same order as above are:

π -Complexes with Diethyl aniline						π -Complexes with p-anisidine					
Silicagel G		Magnesium Silicate		Alumina		Silicagel G		Magnesium silicate		Alumina	
Mono-chloro-benzene: Ethylene Dichloride (9:1)	Petrol ether: Ethyl acetate (9:1)	Mono-chloro-benzene: Ethylene Dichloride (9:1)	Carbon tetra-chloride	Mono-chloro-benzene: Ethylene Dichloride (9:1)	Petrol ether: Ethyl acetate (9:1)	Mono-chloro-benzene: Ethylene Dichloride (9:1)	Petrol ether: Ethyl acetate (9:1)	Mono-chloro-benzene: Ethylene dichloride (9:1)	Carbon tetra-chloride	Mono-chloro-benzene: Ethylene dichloride (9:1)	Carbon tetra-chloride
.33	.19	.36	.11	.41	.14	.41	.16	.56	.12	.30	.50
.37	.13	.40	.06	.45	.08	.46	.21	.79	.28	.54	.43
.00	.00	.00	.00	.00	.00	.03	.00	.00	.00	.00	.00
.65	.46	.76	.49	.72	.53	.72	.65	.82	.44	.80	.72
.55	.39	.53	.20	.58	.43	.65	.55	.65	.31	.66	.64
.58	.34	.70	.47	.70	.47	.76	.50	.76	.59	.78	.86
.66	.45	.71	.51	.52	.22	.54	.28	.66	.34	.56	.54
.70	.43	.75	.67	.73	.55	.80	.64	.83	.74	1.00	.93
.61	.42	.68	.44	.18	.13	.53	.33	.72	.37	.84	.60
.48	.18	.50	.17	.56	.34	.62	.36	.60	.42	.62	.76
.54	.38	.59	.39	.25	.19	.47	.30	.75	.46	.91	.69
.40	.14	.42	.22	.60	.21	.49	.48	.67	.52	.82	.82

Refs: 1) A.R. Cooper, et al, *Trans Faraday Soc*, 62 (10), 2725 (1966) 2) K. Malinowska; *Chem-Anal (Warsaw)*; 9, 353 (1964) 3) R.J. Cvetanovic et al, *CanJChem* 42, 2410 (1964) 4) H. Kessler & E. Mueller, *J Chromatog* 24, 469 (1966) 5) M. Franck-Neumann & P. Jossang, *J Chromatog* 14, 280 (1964) 6) R.S. Mulliken, *JAmChemSoc* 72, 600 (1950); 74, 811 (1952), *JPhysChem* 56, 801 (1952) 7) R.S. Mulliken & L.E. Orgel, *JAmChemSoc* 79, 4839 (1957) 8) D.B. Parihar et al, *Explosivst* 12, 281 (1968) & *CA* 71, 31917 (1969)

High Explosives, Detonics of is a book by C. H. Johansson & P. A. Persson, Academic Press, London & NY (1970). Quoting from the preface: "The authors have been actively engaged in many of the problems of initiation, detonation and effects of high explosives encountered. Due to the policy of free international exchange of results that was followed, they have been able to meet and exchange ideas, on the basis of personal friendship, with scientists from many parts of the world engaged in similar work. They have had the opportunity of seeing the problems of explosives manufacture and application not as interesting abstract problems of theoretical science, but as experimental problems to be solved in order for technical and economical progress to be made

In the present volume, the authors have attempted to give a systematic and coherent account of the experimental phenomenology of the initiation, detonation, and physical effects of detonating high explosives. In ever-increasing quantities, explosives are used both in rock blasting and in an increasing number of new and unorthodox technical processes. For all these applications, charge sizes have to be calculated, effects have to be predicted, problems of initiation and safety have to be solved, and young engineers and scientists have to be taught the basic principles. Although we still lack a detailed and completely clarifying theory for the complicated explosives phenomena involved, the present text may be used by the practising engineer, scientist, or safety inspector as a source-book for essential experimental facts and figures. The student, if he skips the experimental details, may use it as a textbook on the physics of explosives and explosive phenomena

The word "detonics" in the title is chosen in preference to the word detonation to indicate the physics of detonating high explosives and their mechanical effects. The major emphasis is on commercial high explosives for rock blasting, with the exclusion of "Permitted Explosives" and the many complicated problems connected with these

The first three chapters deal with the mechanism of detonation and the initiation of detonation by means of strong shock waves or mechanical impact at low velocity. Burning and the effects of heating are treated in Chapter 4, and in Chapter 5 is given a systematic discussion of the various phenomena of light emission during detonation. Chapter 6 is devoted to a fairly detailed survey of the mechanical effects in surrounding media and a discussion of the work performed by the reaction products of a contained charge. Particular attention is paid to the effects of a charge in rock. The final chapter is an introduction to such methods and results of the physics of high dynamic pressures in condensed media as have appeared essential to the understanding of the mechanical effects of detonation

The authors have felt in their own activity a need for a systematic survey of current experimental facts and data of real explosives as a complement to existing theoretical treatments of idealized explosives and detonation phenomena. The theoretical treatment has therefore been deliberately limited and is included mainly with the purpose of simplifying the account of experimental results

Of necessity, the choice of results and data has been determined by the experimental work and applications in which the authors have been engaged. Wherever possible, results published by workers outside Sweden have been included, but the authors are fully aware of the difficulty in doing justice to the great number of scientists in many parts of the world who have made important and beautiful contributions to this field of research

The major part of the experimental work described has been done since 1946 in the Physics Research Laboratory (Detoniklaboratoriet) of Nitro Nobel AB and from 1953 at the Swedish Detonic Research Foundation. Some of the work has been done since 1960 at the Swedish Research Institute of National Defense"

High Explosives, History of. See under HISTORY OF EXPLOSIVES AND RELATED ITEMS

High-Explosive Train. See Vol 4, p D838 & D839. Figs 1-21a & 1-21b

High Grade Nitrocellulose. Same as Guncotton described under Cellulose and Derivatives in Vol 2, p C106-R

High Nitrogen Nitrocellulose. See under Cellulose and Derivatives in Vol 2, p 108-R

High-Low Pressure Gun (H/L Gun). See Hoch- und-Niederdruckkanone in PATR 2510 (1958), p Ger 90-R & in this Vol

High and Low Temperature Tests for Small Arms Ammunition. The purpose of these tests is to determine the effect of high (as high as +165°F) or low temperature (as low as -70°F) storage upon the ballistic performance of ammunition, or components thereof

The detailed description of the test is given in Ref

Ref: Anon, Ordnance Proof Manual 7-24 (1945), p 7

High Mechanical Strength Explosives. Hopper (Ref 1) evaluated HMX bonded with "Exon 461," a Firestone Plastics Co, Pottstown, Pa, fluorocarbon polymer, for an application requiring a high-energy, high mechanical strength expl. Comps in the range 85-95% HMX & 5-15% Exon 461 were prep'd as granular molding powds and compressed into large cylinders in a heated mold. As the percentage of HMX was increased, the d increased from 1.84 to 1.86 g/cc, and the deton vel increased from 8388 to 8838 m/sec. The compn 85/15 HMX/Exon gave the greatest mechanical strength, at RT its compressive strength was 11000-12000 psi and tensile strength of 1100-1500 psi. Storage at 160°F for 100 days had no appreciable effect on mechanical props measured at RT. Especially noteworthy is the excellent thermal stability of HMX/Exon in the 120°C vacuum stability test

A number of plastic-bonded expls based on HMX & RDX plus polymeric binders has been developed at the Lawrence Livermore Lab, University of California, Livermore. Their props have been compiled by Dobratz (Ref 2)

Refs: 1) J. D. Hopper, PATR 2592 (Feb 1959)
2) B. M. Dobratz, "Properties of Chemical Explosives and Explosive Simulants," UCRL-51319 (Dec 1972)

High Nitrogen Content Compounds as Flash Reducing Agents. Some aliphatic nitramines of low carbon content were prep'd & studied for use as ingredients of flashless propellants. Nitro-urethane, Dimethylnitramine (See Vol 5, p D1306-L) & Cyclotrimethylene trinitrosamine (See Vol 3, p C630-R) were found to be unsuitable for use in proplnt compns. Dinitrodiacetylmethylenediamine had properties which indicated it offered promise and tests were recommended to determine the practicability of using it in proplnts (Ref 1)

Benson (Ref 2) also reported that some success had been achieved in the reduction of muzzle flash by incorporating high nitrogen compds such as Dicyandiamide (See Vol 3, p C587-L) & Nitroguanidine. In order to extend this approach and to investigate other compds, selected hydrazine derivs were prep'd & studied. Cyanuric Hydrazide & 5-Amino-tetrazole (See Vol 1, p A258-L) were of greatest interest because of their high nitrogen content and other props

Since 5-Amino-tetrazole (ATZ) was not available commercially at that time, Benson (Ref 3) also reported a method for the synthesis of ATZ of 99% purity in 70-85% yield by reaction of Na nitrate & aminoguanidine bicarbonate dissolved in nitric acid, followed by treatment with Na acetate. Davis (Ref 4) prep'd Cal .50 gun proplnts and determined the optimum percentage of 5 to 10% ATZ without DNEB (Dinitroethylbenzene), but coated with 5 to 0.8% DNT, gave acceptable service ballistics. The proplnts gave completely flashless rounds in 45-inch barrel rifle and machine gun with an APG-flash hider

Nine new materials of high nitrogen content were studied by Sheffield (Ref 5) and attempts were made to reduce the hygroscopicity of ATZ. Of the new compds investigated, Melamine was found to be the most promising from the standpoint of its props & availability, but Cyanuric Hydrazide was only slightly inferior in these respects. Physical treatment of ATZ had no significant effect on its hygroscopicity, and chemical treatment did not yield material of promise

Helf (Ref 6) investigated ten new materials as flash & smoke suppressants in propints. Guanylurea Nitrate was the most promising compd with regard to physical & chemical props, stability, and O balance. Guanylnitro Urea was unsuitable for propints contg NG. Carbohydrazide-N-carboxamide & Carbohydrazide-N,N'-dicarboxamide showed desirable promise but depended on a special starting material. Ammonium Nitrourea, Diammonium-methylene-bis-(nitrosohydroxylamine) & Guanidine Oxalate were investigated and found unsatisfactory because of their chemical & stability props

Continuing this investigation Helf (Ref 7) found Carbohydrazide Oxalate, Dinitrobiuret, Diaminobiuret, Hydrazine Oxalate, & Hydrazine Nitrate were either unsuitable or not compatible with Nitrocellulose. Urazine, N-Guanyloxamic Acid and Cyamelide were stable compds of good physical props but their methods of prepn limited large scale production. Nitrobiuret, although decomposed at 100°C, was stable & compatible with NC, and was of particular interest as a non-smoky flash reducing agent. Guanylamino-tetrazole & Guanylamino-tetrazole Nitrate possess good physical props & are compatible with NC. Both should yield cool propint compns with good ballistic potential. Nitroguanylamino-tetrazole, not previously described in the literature, appeared to have excellent potential as an ingredient of low-temp, high-force propellants

Audrieth et al (Refs 8, 9 & 10) also prepd & investigated compds of high nitrogen content with a view toward their use in propln & HE compns for PA

Muzzle flash, which is undesirable in gunnery because it discloses position, interferes with vision of gunners, and interferes with guidance and telemetry, is due to the combustion of product gases CO & H₂. Current US composite nonflashing propints are based on British Cordite N, containing Nitroguanidine, while German Nitroguanidine Propellant is considerably cooler because it employs Diethyleneglycol Dinitrate instead of NG as the plasticizer for NC

See Flashless Cordites in Vol 3, p C522-R
Refs: 1) F. R. Benson, PATR 1174 (June 1942) (Aliphatic nitramines of low carbon content)

2) F. R. Benson, PATR 1409 (April 1944) (Hydrazine derivs) 3) F. R. Benson, PATR 1548 (July 1945) (Synthesis of 5-Aminotetrazole) 4) C. S. Davis, PATR 1615 (July 1946) (Propints contg ATZ) 5) O. E. Sheffield, PATR 1694 (May 1948) (High nitrogen compds) 6) S. Helf, PATR 1752 (Nov 1949) (High nitrogen compds). 7) S. Helf, PATR 1841 (Oct 1951) (High nitrogen compds) 8) L. F. Audrieth & P. G. Gordon, "Compounds of High Nitrogen Content," Final Rept, Part 1, "The Chemistry of Allophanyl Hydrazide and Urazole," Univ of Ill, Urbana, Ill (March 15, 1954) 9) L. F. Audrieth & J. W. Currier, Ibid, Part B, "Derivatives of 5-Aminotetrazole," Ibid (June 15, 1954) 10) L. F. Audrieth & W. L. Curless, "Preparation and Properties of Some Oxalates of High Nitrogen Content," Ibid, (1954) (Contracts DA 11-022-ORD-33, Proj TA1-3601 and W-11-022-ORD-11329) 11) Fedoroff & Sheffield, PATR 2700, Vol 1 (1960), pp A257-R to A262-L (AMINOTETRAZOLE AND DERIVATIVES) (Included are more than 100 refs)

High Pressure Effect on Explosives. Bridgeman (Ref 1) determined that purely hydrostatic pressures as high as 10⁵ atms will not initiate explosives even as sensitive as *Lead Azide*. In fact there is evidence that high pressures slow down thermal decomposition of explosives. Bowden et al found that for *Cyanuric Triazide*, *Lead Azide* & *PETN* the time to explosion at a fixed temp, or conversely the temp at a fixed explosion time, increased as the pressure on the system increased from ambient to 22,500 atms (Ref 2). For *Cyanuric Triazide* this effect was appreciable but for *PETN* it was very slight. Bowden suggests that these observations are understandable in terms of LeChatelier's Principle since all of these explosives produce large vols of gas on explosion so that application of external pressure is expected to repress the explosion reactions. The larger degree of repression for *Cyanuric Triazide* than for *PETN* may be rationalized by the lower explosion pressure of the former than the latter. Thus 22500 atms may be a significant fraction of the explosion pressure of *Cyanuric Triazide* while it is only a relatively small fraction of the explosion pressure of *PETN*

Recently Lee et al (Ref 3) re-examined the behavior of PETN under 10 to 50 kbars of external pressure. They also find a reduction in decomposition rate with increasing applied pressure. HMX behaves similarly to PETN. TNT whose explosion products contain a high proportion of solid carbon, as expected from LeChatelier's Principle, shows little pressure effect on its thermal decomposition. Nitromethane, however, appears to decompose more rapidly under an external pressure of 50 kbars than 10 kbars. This effect is not completely understood but Lee et al suggest that high pressure may favor the formation of the thermally less stable *aci* form of Nitromethane:

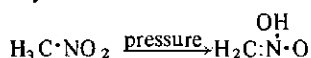

Written by J. ROTH

Refs: 1) P. W. Bridgeman, *JChemPhys* **15**, 311 (1947) 2) F. P. Bowden et al, *DiscFaradSoc* "High Pressure Reactions" Sept 1956 3) E. L. Lee et al, *Proc 5th Detonation Symposium* (1970) p 331

High Pressure Pump. See Hochdruckpumpe (HDP) oder V-3 in this Vol

High-Pressure Technique (Hochdrucktechnik—in

German). The term "high pressure", according to Dodge (Ref 19), refers "to any pressure above a lower limit of about 50 atms (750 psi)"

Applications of high pressures in chemical industries dates from the beginning of this century, when the industrial synthesis of ammonia from the elements was first achieved by Haber, LeRossignol and others. The Burton process for oil cracking dates from about 1913

At present, pressures of the order of 1500 atms are widely used, but the technique for carrying out reactions under pressures up to about 10,000 atms is fairly well developed. In research laboratories, pressures as high as 150,000 atms (3,000,000 psi) have been used to a limited degree

One of the principal applications of high pressure technique in industry is to increase the chemical reaction rate

High-pressure operations are conducted in special reaction vessels which may be divided into batch reactors, such as autoclaves (qv) and continuous reactors. Continuous reactors consist of long cylindrical tubes, constructed of steel in a manner to resist pressures as high as 1500 atms. Inside the thick-walled reactor, a thin-walled vessel containing a catalyst is placed. The incoming gaseous reaction components, previously preheated (by allowing them to flow along the outside of the reactor), enter the reaction chamber, pass through the catalyst where they react, forming the desired product, and exit through the other end of the reactor into a cooler where they are collected as a gas, liquid or solid

Refs: 1) H. Tongue, "Design and Construction of High Pressure Chemical Plants," Van Nostrand, NY (1934) 2) M.E. Bonyun, *Chem & Met-Engr* **42**, 260-263 (1935) (Protecting pressure vessels with rupture disks) 3) V.N. Ipatieff, "Catalytic Reactions at High Pressures and Temperatures," Macmillan, NY (1936) 4) C.W. Seibel, *IEC* **29**, 414 (1937) (Factors in high pressure design (32 references) 5) R. Taylor, *JSCI* **56**, 41T to 50T (1937) (High pressure technique; the design of high-pressure equipment is discussed) 6) A.Eücken & M. Jakob, Edit, "Der Chemie-Ingenieur," Akademische Verlagsgesellschaft, Leipzig, v 3, part 4 (1939) (Reproduced by Edwards Bros - Ann Arbor, Mich) 7) D.M. Newitt, "The Design of High Pressure Plants and the Properties of Fluids at High Pressures," Clarendon Press, Oxford (1940) 8) Roger's Manual of Industrial Chemistry, Van Nostrand, NY (1942), v 1, Chapt 4 (Article by B.F. Dodge) 9) J. Reilly & W.H. Rae, "Physico-chemical Methods," Van Nostrand, NY (1943), v 1, pp 323-345 10) D.B. Gooch, *IEC* **35**, 935 (1943) (Autoclaves for pressure-temperature reactions) 11) D. P. Meigs, *TransAmInstChemEngrs* **39**, 769 (1943); *Canadian Chem Proc Inds* **28**, 309 (1944) (Closures of high pressure vessels) & *CA* **38**, 897, 3515 (1944) 12) P. W. Bridgman, *Rev Mod Phys* **18**, 1 (1946) (Recent work in the field of high pressure. Review of the entire field between 1930 and 1945 with 647 references) 13) Krase, "Design and Construction of High Pressure Compressors and Reaction Equipment," *FIAT Final Rept* 611 (1945) 14) H. C.

Hesse & J. H. Rushton, "Process Equipment Design," Van Nostrand, NY (1945) 15) C. F. Boe, *Chem & Met Engrg* **53**, No 3, 114-116 (1946) (Simplified methods for calculating stresses in pressure vessels) 16) Reynolds, "A Survey of High Pressure Designs in Germany," *FIAT Final Rept 1067* (1947) 17) E.L. Clark et al *IEC* **39**, 1555-64 (1947) (High pressure reactions, 5 references) 18) Collective, *Chem Engrg* **53**, No 8, 107-127 (1949) (High Pressure; several papers and references) 19) J. H. Perry, Ed, "Chemical Engineers' Handbook," McGraw-Hill, NY (1950), pp 1233-1262; B.F. Dodge, "High-Pressure Technique"; 4th edit (1963), p 5-2ff 20) R.H. Wentorf, "Modern High Pressure Techniques", Butterworth, London (1962) 21) R.S. Bradley, "Advances in High Pressure Research", Academic Press, NY (1966) 22) K.E. Weale, "Chemical Reactions at High Pressures", Spon, London (1967) 23) D.S. Tsiklis, "Handbook of Techniques in High-Pressure Research and Engineering", Plenum Press, NY (1968) 24) D. Bienek & F. Korte, *Naturwissenschaften* **59** (12), 539-53 (1972) (Organic High Pressure Chemistry, 21 refs)

High-Pressure Test (HPT) Cartridge. See under Cartridge, Ammunition, Vol 2, p C74

High Rate Detonator Production Study. As part of the overall program to modernize the US Govt owned, company operated, Army Ammunition Loading and Assembly Plants, it is planned to develop fully automatic equipment to manufacture nonelectric detonators at the rate of 1200 per minute. The survey of literature sources and industry was undertaken to discover techniques and equipment that may be applicable, as described in Ref 1

Refs: 1) E.E. Hannum, "Survey of Techniques and Equipment for High-Volume, Automatic Production of Non-Electric Detonators", *PATR* **4541** (1974) 2) G. Cohn, Edit, *Expls&Pyrots* **7** (5), 1974

HIGH SPEED PHOTOGRAPHY

Introduction

High-speed photography provides the main observational facility in the study and measurement of explosive phenomena. In Vol 2, pp C13-19, many *high-speed* cameras are described

& some of the techniques for using them are discussed. The present article deals with broader aspects of *high-speed photography*. Not only is the information on high-speed cameras brought up to date and extended, but other aspects of high-speed photography, such as illumination, films & film processing are discussed
Advances in Shuttering Systems

High-speed photography serves to extend and help calibrate other even more rapid systems of data recording. The use of cameras and other optical and electronic devices has kept pace with advances in high energy physics. The extremely brief exposures required for photographing the effects of explosion phenomena are achieved by regulating the optical, electrical and mechanical design of the camera's shuttering system

The picture taking rate for photographic recording of rapid moving or brief duration phenomena has steadily increased from "slow-motion" techniques at 64 pictures-per-second (pps) to more than millions of pps. Time resolution has now been extended down to the order of 10 picoseconds or less. Three classes of high-speed photography are recognized. According to their time and rate of picture-taking, they are called: high-speed, very high-speed and ultra-high-speed photography
High-Speed & Very High-Speed Cameras

The first *high-speed* cameras accomplished action stopping exposures at more than 1000 pps. These rotating prism cameras (Ref 2) eliminated the start-and-stop clawing action of conventional motion picture cameras. The 8mm size film moved continuously and had relatively poor resolution. Later models, using 16mm films, reached speeds of more than 40,000pps. By increasing the number of faces in the prism shuttering device each standard 16mm frame is split into 2 or 4 frames, thereby increasing the pps. Greatly increased detail resolution was achieved at first by going to larger film formats such as 35mm and finally 70mm. In recent years newly developed anti-reflection lens and prism coatings produced substantially better contrast, higher resolution and more effective light transmission by reducing glass interface glare and reflection

Prior to World War II, Dr. C. N. Hickman of Bell Labs invented the "ribbon-frame" camera using the inexpensive 122 size (post-

card) amateur roll film. This camera was a variation of the rotating prism shuttering system that substituted plane-parallel glass plates inside of a variable-slitted rotating cylinder running continuously. When a clutch was engaged a short length of film moved steadily past the shutter slit. Although originally created to photograph arrows in flight (one of Dr. Hickman's hobbies was archery), since he was the co-inventor of the portable rocket launcher weapon, it proved useful in the study of rocket trajectories as well as static fired rocket motors (Dr. Hickman was also the co-inventor of the *bazooka*)

A more sophisticated and considerably larger version of this type of camera was developed by Drs. Bowen & Knapp and bears their names (Ref 14). The Bowen-Knapp camera used 9-inch wide rolls of aerial camera film. It came into use late in World War II, but its use was restricted to studies of trajectories, rocket propellants and low order detonations because of its limited maximum speed, comparable to that of rotating prism cameras. Its main difference from the cine-type cameras was in the film format, which resembles a long "venetian-blind" series of pictures. Usually a number of studies could be made on each roll since no film acceleration was required. Timing was indicated by a pulsed light recorded on the edge of the film. Space and movement data was generally reduced by using microscope or projection comparators against fiducial marks recorded from the pre-surveyed scene field

The newest example of high-speed motion picture camera of the rotating-prism type is the Photec IV—see sketch (from Ref 26)

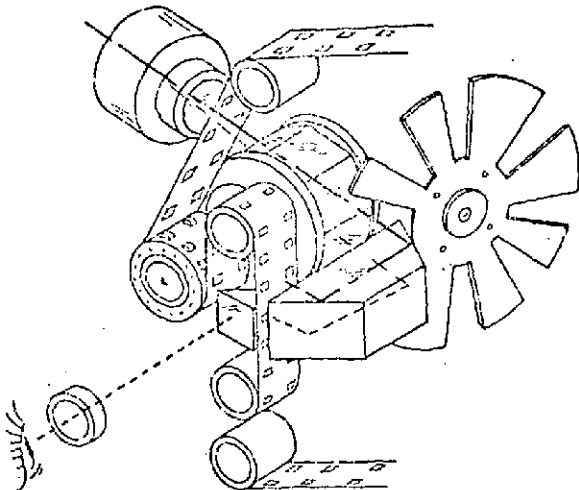

Mechanism of rotating prism Photec camera

Film advance sprocket and image motion compensation prism are mounted on a single shaft to improve precision of registration

These cameras, generally using standard 16mm motion picture film (although Fastax also made 35mm film models as well as the original 8mm size) are efficient at picture taking rates from 100pps to 10,000pps. The Photec IV, through an improved yet simplified optical design, permits an effective aperture of f:2.8 to be attained. This 2-stop gain over the "competitive" models allows four times as much light to reach the film. The optical/mechanical design advance allows the picture-taking rate to be increased, the shuttering time to be reduced substantially (to one/fiftieth of the picture-taking rate). An additional benefit is the reduction in heat reaching the subject because weaker light, and consequently "cooler," sources can be used. Thus the Photec IV brings motion picture cameras into the very high-speed photography group. Further references to the subject of very high-speed cameras are covered in the Proceedings of the International Congress on High-Speed Photography (HSP), 1 through 10. These excellent surveys have been published nearly every two years since the First International Symposium on High-Speed Photography in Oct 1952

High-Speed Video Systems

The next few years should produce effective high-speed television image sequences. At present, video systems are limited to a picture taking rate of less than 200pps and are consequently classified as slow motion photography, although the data recovery rate, or read-out, is instantaneous. It is expected that an increase in the framing rate by an order of magnitude will be forthcoming soon. This will put video systems in high-speed category

Ultra High-Speed Cameras

It is in the area of ultra high-speed photography that the most significant advances are now taking place. Exposure time has steadily been reduced from microseconds, through nanoseconds to 10 or less picoseconds (10^{-12}). A pulse of light has now been photographed with a movement blurring of the image of less than two millimeters (Ref 26). This achievement in ultra high-speed photography is due to a unique

electronic shuttering system, namely a *Kerr cell* that opens and closes (optically) in 10 picoseconds. No electrodes are required and carbon disulfide has replaced the heretofore traditional nitrobenzene. A first-harmonic pulse of light from a Nd:glass laser is used to drive the shutter

Image Dissection Cameras

This type of ultra high-speed camera (Ref 3) also called *lenticular camera*, *high-speed raster camera* (in the USSR), *continuous-access camera* and, more informally, "*scrambled*" *image camera*, seems to have the greatest potential for high-speed photography in the future. Resembling holographic recording (Ref 1) in one sense, inasmuch as it permits the concentration of many sequential images in a limited space, it offers the prospect of ultra high picture taking rates (over 10^9 pps). After an ordinary development process the plate or film can be shown immediately as a motion picture or video image. Eventually, when the resolution of image converter tubes improves, the principle of image dissection should provide the maximum rates of high-speed photography (Ref 23)

This is emphasized in the following table, taken from an excellent summary of state of the art of high-speed photography by Courtney-Pratt. The data in this table also shows that (Ref 26, p 172) there were no spectacular advances in image dissection camera performances in the period 1957 to 1972

Image Dissection Cameras.

Type	Repetition rate, p.p.s.	
	≤1972	≤1957
Clear lines or holes in opaque plate	$10^3 - 10^4$	$10^4 - 10^5$
Slit plate and rotating mirror	10^4	10^4
Lenticular plate, aperture scanning	10^4	2.5×10^4
Lenticular plate with mechanical traverse (including cinematography up to 2000 X)	10^4	10^4
Fiberoptics dissection, long series, low resolution	10^4	10^4
Fiberoptics, short series, resolution of 200 samples per frame width	10^4	—
Lenticular plate, rotating mirror, in U.S.S.R.	10^4	$\sim 10^4$
Lenticular plate or slit plate and image converter tube	$>10^4$	$>10^4$

Other ultra high-speed cameras using rotating mirrors, rotating slotted discs and optical image dissection systems ranging from pinholes to lenticular plate arrangements remain in constant use due to the greater number of frames or pictures produced in sequence. If somewhat less resolution can be tolerated, fiber optic light guides can be used to provide still longer series of pictures

Flash X-rays

Extremely brief flashes of X-rays are useful in the study of the movement of dense materials, such as bullets, shell and bomb fragments, metal liners and containers, through smoke, turbulence and explosive debris (Ref 9). Unaffected by glare, sunlight and other atmospheric conditions, X-rays (radiographs) penetrate, as they do in industrial and medical applications, to detect and reveal the behavior of explosively driven material (Ref 6). Multiple flashes permit stereo or sequential pictures to be made depending on the synchronization, arrangement and number of X-ray sources used. Cineradiography is particularly useful in investigations of such phenomena as explosive welding, where the high-speed action takes place within an optically opaque substance (Ref 10). In addition, obscuration by the very bright luminescence of the detonating explosive charge is eliminated

Along with advances in X-ray technology, progress in electronic image enhancement (see next section on Image Enhancement) permits gains up to fifty times. This permits the extension of flash X-rays into diffraction recording as well as higher rate cinematography (Ref 11)

Electronic Amplification of Light Images & Techniques of Image Enhancement

Perhaps the most important trend at this time in ultra high-speed photography is in the increased use of image amplification (Ref 25). Image converter cameras were developed in recent years not only in the United States but also in England, France, Germany, Holland & the USSR (Ref 5)

The benefits of electronic image enhancement are as follows:

1. Increased sensitivity—2000 to 10,000-fold over the primary image
2. Faster shuttering—sub-nanosecond or less
3. Memory tube delay permits millisecond camera synchronization
4. Reduced distortion—special flatfield, distortion-corrected lenses are used
5. Variable contrast control produces higher signal/noise ratio
6. Eventual application to video systems of high-speed photography

At times the image produced in high-speed photographic studies dealing with explosive phenomena is less than satisfactory. The nature of the subject, the available instrumentation, the cost, unforeseen accidents, such as the failure of a light source to synchronize; all can contribute to substantial underexposure. This results in a low signal to noise ratio making precise film or picture analysis difficult or impossible.

It is customary, when weak images are expected, to employ the most sensitive films available, the so-called "superspeed" films, and if necessary to use chemically vigorous or "forced" development (Ref 6a). The gain in sensitivity generally is in the range of two to ten times the original (manufacturer's) rating of the film's speed. Even color film, such as High-Speed Ektachrome can be exposed at an exposure speed index (EI or ASA speed) of 5000 or more when processed as a negative rather than the customary reversal into a positive film. Even with the resultant increase of coarse grain, the color differences in the subject help reveal useful data.

A technique of "post-fogging" called latensification (Ref 2a) can frequently increase the maximum recording rate up to four times. This is impractical to attempt with long lengths of motion picture film but can be successfully employed with a high-speed still, or short strips of film. Although the procedure raises the threshold speed of films by this pre-development, extra exposure it is not the same as "pre-fogging" which merely lowers the inherent contrast range of films. The difference is in the employment of 5 to 30 minutes pre-development exposure to weak green light, rather than an instantaneous flash exposure to low level white light. It is particularly useful with fast Polaroid photographic material.

In many instances image rescue can be accomplished after the act, eg in case of extreme overexposure. This can be corrected easily by reprinting the film original on to highspeed reversal or negative film stock using an intense print light source. Little or no detail loss will result. An alternate procedure, having some minimal risk to the original film, would be to employ photographic chemical reduction. Standard photographic darkroom technique (Ref 1a) handbooks describe this technique and include recommendations for proportional reducers.

These same references also discuss photochemical image intensification. The process of intensifying a film image is most satisfactory when the image is weak due to underdevelopment in processing. However, even when the faint image is due to underexposure, frequently a much stronger and more detailed image can be produced by use of chromium and mercury type chemical intensifiers.

Occasionally the original, showing an extremely weak image can best be made useful by reprinting or rephotographing the film on to extremely high contrast film such as used in graphic arts. These "process" or "lithographic" films are available in all sizes and are convenient to use as a contrast and detail enhancing agent.

Several photographic feedback techniques were used with these procedures. One is to rephotograph the original film by reflected light as it rests against a very black, low reflective background. The positive image seen usually shows much more detail than direct observation of the original film can reveal. Secondly, there is a device on the photo market that presses the weak original film against a front surface mirror in order to gain a doubling of the "signal" strength. The third and most effective and unique of these techniques is Michel Cloupeau's "optical contraster." (Ref 7a) This system places the badly underexposed original film between semi-reflecting plates, and, by means of collimated light, enables one to choose an image which is the sum of multiple passes through the original film, thereby raising the information signal level substantially. This permits either direct observation or photo reproduction.

Image intensifier systems have developed from the first electronic image converters that were used as fast-acting camera shutters (Ref 3a). Multi-stage image-intensifying circuitry now permits extremely high gain (Ref 5a). Signals due to individual photoelectrons leaving the photocathode of the intensifier have been photographed. Nearly all the information available in low-density electron images can be recorded. In recent years multistage electronic image converters have been developed that produce a light gain from 8000 to 50,000X. (Ref 4a). Film exposure times can be as large as the interframe times, or as short as 5×10^{-9} sec. Picture taking rates from 1 to 100 million pps are easily achieved.

Streak Cameras

Also known as "smear" cameras and continuously-writing cameras, they generally serve to record movement velocities (Ref 26). Two basic principles are applied to the camera design in order to record a continuous section of a moving image. Either the image is optically "wiped" along a strip of photographic film lining a drum by a rotating mirror or prism system or the film itself is moved at a known rate past the image. Since only a point of light is necessary to be observed as it is displaced or moved normal to the film's directional axis, the real image of the subject is focused on to a slit nearly in contact with the film. As the image of the action being observed travels along the slit, this multiplicity of points photographically are "streaked" on to the film at a known rate. Frequently two or more slits are used when more than one action is to be observed. Spatial resolution is determined by the narrowness of the slit, the velocity of the image/film travel rate, and the optical resolution of the lens system

As shown in the table below (from Ref 26), there has been a considerable improvement in the time-resolution capability of streak cameras in the last two decades

Characteristics of Streak Cameras.	Time resolution, s	
	≤ 1972	≤ 1957
Streak cameras		
Streak record. drum camera	5×10^9	10^{-7}
Streak record, rotating mirror, single rotor	2×10^{-9}	10^{-8}
Streak record, rotating mirror, multiple reflection	10^{-10}	0.25×10^{-9}
"Schardin Limit"	0.25×10^{-9}	0.25×10^{-9}
Deflecting image converter tubes . .	$(2 \text{ or } 3) \times 10^{-12}$	10^{-10} , 10^{-11}

The format or film size, shape and dimension, runs the full range of photographic recording. Early streak cameras consisted of a large strip of film wrapped around a drum electrically driven to rotate at a high speed. (See diagram taken from Ref 26)

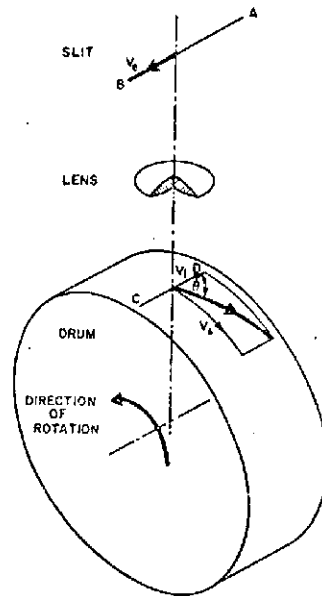

Diagram of a simple drum camera. From measurements of the streak record, velocities of movement of the object can be determined relative to the speed of movement of the film. The image-illuminated slit recorded when a steady rate of film movement was achieved. Motion picture films were used in the 35mm and 70mm sizes in somewhat similar arrangements. Most of the more recent designs of streak cameras substitute rotating mirrors for the moving film and can give a time resolution at least an order of magnitude greater than the moving film type (Ref 12)

A somewhat unusual approach is encountered when high-speed motion picture cameras of the Hycam type are used as a streak camera. This is accomplished by filming through the camera's viewfinder which bypasses the prism system that normally cuts up the scene into frames or pictures. After nearly one-fourth of the film has run through the camera the voltage-controlled rate of film travel is reasonably steady and can be used for velocity measurements.

Variations in film travel speed are easily ascertained by the millisecond markings imprinted along the edge of the film as the camera runs. Two advantages are gained by this technique: one, the camera can be set to initiate the subject action at any pre-determined delay; and two, since the film never is exposed again to

the subject as with a rotating mirror system, danger of re-writing is eliminated. Film lengths up to 1000ft can be used in this manner. However, most of the time, continuous-running cameras, using short lengths of film, are used and double exposure caused by the over-run or re-writing is avoided by high-speed shuttering

External Shuttering

Frequently it is as necessary to cut off the illumination as quickly and precisely as it is to turn it on. Internal electro-shuttering, such as accomplished with the Faraday and Kerr cells, can be synchronized with the camera and event exactly as needed (Ref 17). However, as mentioned above, cameras such as the Beckman/Whitley framing camera as well as most continuously writing "streak" cameras, run the risk of incurring double exposures (Ref 13). This is due to the image re-writing propensity of the rotating mirror and many drum-camera systems. Small auxiliary detonating charges can be used in a number of ways to block off light and image exactly when required. Some of the methods used are listed below:

1. Explode a small charge in contact with a block of glass in the image path. The internal multiple cracking caused by the charge makes the glass effectively opaque
2. Blast a mirror out of the optical path to terminate recording of the event
3. Implode a ring-shaped explosive charge of Primacord wrapped around an aluminum cylinder through which the light travels to the film
4. Wrap a coil of Primacord explosive, sometimes covered with black grease, around the camera observation port window safety glass outside the instrument shelter. Detonation of the explosive coil creates a dense black smoke cloud. This method is usually called a *smoke shutter*

Illumination for High-Speed Photography

Despite the presence of brilliant light produced by an explosion, additional high-intensity illumination is often necessary to record high-speed phenomena. Also, it is frequently required to regulate the length of the picture taking sequence by controlling the duration of a supplementary light source

Spark Light Sources

The original "instantaneous point" light

sources was an electric spark discharged from primitive capacitors of the Leyden jar type. Thanks to General Liebessart and other early experimenters (Ref 4), the spark evolved to become a controlled, channeled efficient light source. However, at present it is more useful in ballistic and wind tunnel studies of aerodynamic phenomena than for studying explosives. Confined sparks are still used as a primary point source in Schlieren high-speed photography. This is particularly useful in shockwave studies. Frequently, inexpensive expendable fresnel lenses (plastic) are used in conjunction with spark light sources to redirect much of the spark light into a small lens aperture on the camera. This application of high-speed photography, usually referred to as *shadowgraphy*, is useful in studying strong disturbances in a transparent medium such as air, water and glass when a powerful shockwave or high temperature boundary is present

Flash Lamp Light Sources

Electronic flash lamps are used when the light duration has to extend into milliseconds rather than the microsecond range (Ref 7). Ultra high-speed cameras such as the Beckman/Whitley 189 framing camera can produce 25 or more sequential photographs during one flash of a small electronic flash, commonly, but incorrectly, called a "strobe" light. Repeating electronic flash units have been made in Germany that permit a picture taking rate up to 10,000 pps at quite high intensities. However, in the United States when a nondestructive extended light source is required, conventional photo-flash lamps are generally used to provide intense illumination. Arranged in overlapping relay sets they supply light enough to cover a full length motion picture roll in a rotating prism type of camera such as the regular high-speed cameras mentioned at the beginning of this article

Explosive Light Sources

Still higher energy light sources can be fabricated. These use blocks of high-explosive such as Comp B detonated at one end of a tube or funnel-shaped cone filled with argon, krypton or xenon (Ref 8). These ionizable gases serve as the light emitting source. Temperatures in the vicinity of the shock wave in argon can exceed 28,000°K (Ref 15), but strangely enough

it affects color film much as a pulsed daylight quality source. The duration and luminosity of this type of explosive "candle," using free-flowing argon, can range up to more than 500 microseconds at intensities much exceeding sunlight. Lining the light source tube with aluminum foil covered sheet explosive may help in achieving the longer duration (up to 500 μ sec) luminosities. Reflecting surfaces on the inside of the argon container have the effect of making the light source have an apparent radiating area greater than its actual cross-section. Thus, an argon light source with a reflecting internal surface illuminates a target more effectively than an identical light source with matte surfaces. The length of the light path is roughly proportionate to the duration of the luminosity if rarefaction effects can be minimized.

Laser Light

New techniques in high-speed photography have been aided by recent developments in laser technology (Ref 19). In some instances the monochromatic nature of laser illumination has been useful in replacing fast X-rays in order to perceive important details in self-luminous events (Ref 18). The steady increase in use of lasers permits simpler interferogram systems to be arranged. In addition, hologram techniques are now practical with sub-nanosecond exposures. This extends interferometric procedures into a true 3rd-dimensional recording system.

Non-expendable light sources, such as a Q-switched pulsed laser can be protected from destructive forces encountered in the photography of explosive material by piping the light through fiber optics to the experimental zone. Occasionally lens systems are used to relay the light from mirrors located near a protective barrier shielding the laser (Ref 16).

Photographic Films and Processing Procedures

High-speed photography benefits by certain changes in modern films. Many of the newer film emulsions are now coated on polyester plastic bases. In addition to attaining dimensional stability approaching that of glass, these films are thinner and stronger than the conventional acetate film supports hitherto used. This permits more film, thereby a longer run, on a given motion picture size spool. The increased strength and resistance to tear allows more

rapid acceleration with no torn sprocket holes in all moving film type high-speed cameras. One detriment with the new mylar type films is that conventional splicing can not be used—pressure sensitive clear tapes seem to be the most practical approach to the joining of film lengths.

A still more useful improvement is in increased sensitivity. Exposure indices (EI) or film "speed" now easily attain the range of 2000 to 5000, an increase of 10 fold over former high-speed films. With vigorous film processing at high temperatures, color and black & white films have been successfully exposed at an EI of 6400. The use of Polaroid film continues to expand with a soon-to-be available fast film effectively equal in "speed" to 50,000.

High temperature film processing not only now permits film to be processed in the tropics and in high temperature locations but allows the specially hardened emulsions to develop very rapidly with no detrimental changes in their characteristics.

Color Photography

The use of color film in many instances extends the usefulness of high-speed photography. When more than one explosive subject is being studied simultaneously, it is convenient to observe each through complementary or contrasting color filters. With streak cameras using more than one slit on the same experimental shot, the color contrasting hues can overlap and intermingle and still be free of double exposure confusion. This is done simply by placing a clear bright-colored gelatin filter over each camera slit so that the resulting streaks are rendered in the hue pertaining to a particular slit.

Specially made color filters can be inserted in place of the conventional knife-edges in Schlieren systems (Ref 20). Frequently this produces higher resolution because of the avoidance of knife-edge diffraction. Restricting parts of the subject image to monochromatic recording also presents additional gains in sharpness. Composite color filters placed at field stops in the optical system can add considerable information to the photo image when captured on color film.

Special Color Films

A Kodak color film with the blue layer

quite sensitive to infra-red radiation is now commonly available. This enables dynamic thermography to be included in high-speed photographic recording

The use of color film for high-speed photographic studies of explosions underwater has been made more feasible by GAF's new Blue-Insensitive Anscochrome Aerial Film which does not have a blue-sensitive top layer (Ref 21). This high-speed (EI nearly 1000) color film has high resolution and eliminates the need for a minus-blue filter on the camera. Schlieren and photoelastic stress analysis can conceivably gain in contrast with this new film. In addition, it should be less affected by smoke and other explosive debris which scatters the shorter wavelength light (blue) more than "red" light

Lastly, a somewhat unorthodox color film, referred to as Extended Range (EG & G) film permits photographing an explosive subject over an extremely wide exposure range. This multiple layer color negative film permits photography requiring effective exposure ratings from approximately .03 or slower to a maximum equal to EI 400. Originally developed to photograph the sun's corona, it has found use with high-speed photography when the correct exposure is difficult to determine. This film, however, produces colored images in blue, red, and yellow that bear no relation to the subject's original colors

An experimental new color film called XRC (for extended response color) has been introduced by Applied Photo Sciences Inc (Ref 22) that is a "true" color film. It too has a remarkably extended exposure range of responses to scene brightness, said to "nearly match the human eye"

An excellent review of advances in high-speed photography is presented by Courtney-Pratt in Ref 22, listing 115 references. Additional source material, taken from Courtney-Pratt's article, is listed at the end of the references to this article

Written by ZEV PRESSMAN

Refs: 1) C. Cranz & H. Schardin, *ZPhysik* **56**, 147 (1929) 2) J.H. Waddell, *JSocMotionPictureEng* **46**, 87 (1946) 3) M. Sultanoff, *J SMPTE** **55**, 158-166 (Aug 1950) 4) J.S.T. Looms & R.J. North, *HSP**3*, 62-66(1956) 5) G.H. Lunn, *HSP* **3**, 102-107 (1956) 6) R. Schall, *HSP* **3**, 228-237 (1956) 7) H.E. Edger-

ton & D.A. Cahlander, *HSP* **5**, 3-5 (1962) 8) Z. Pressman, *HSP* **5**, 56-60 (1962) 9) F.J. Grundhauser et al, *HSP* **5**, 149-153 (1962) 10) A. Stenzel & G. Thomer, *HSP* **5**, 173-175 (1962) 11) G. Thomer & R. Schall, *HSP* **5**, 176-178 (1962) 12) T.P. Liddiard, Jr. & B.E. Drimmer, *HSP* **5**, 322-328 (1962) 13) S.J. Jacobs, *HSP* **5**, 335-340 (1962) 14) L.E. Davidson, *HSP* **5**, 462 (1962) 15) J. Roth, *JApplPhys* **35** (5) 1429 (1964) 16) J.K. Crosby & R.C. Honey, *ApplOptics* **2**, No 12, 1339-1340 (Dec 1963) 17) M. Blanchet, *HSP* **6**, 313-320 (1964) 18) L.E. Hargrove & J.S. Courtney-Pratt, *J SMPTE* **74**, 1085-1095 (Dec 1965) 19) V.V. Korobkin et al, *HSP* **9**, 232-236 (1970) 20) J.R. Meyer-Arendt et al, *J SPIE* **9**, 18-21 (Nov 1970) 21) W.G. Hyzer, *PMI (Photo Methods for Industry)* 18-20 (Jan 1971) 22) C. Wyckoff, *PMI*, p 20, (Jan 1971) 23) A.S. Dubovik & N. M. Sitsinskaya, *J SMPTE* **80**, 691-698 (1971) 24) W.G. Hyzer, *Research/Development*, p 56 (Aug 1972) 25) V.A. Babits, *Photographic Appl in Sci, Tech & Med*, 22-28 (Jan 1972) 26) J.S. Courtney-Pratt, *J SMPTE* **82**, 167-168 (Mar 1973)

* *J Soc Motion Picture & Television Engr*

** *Proc Intl Congress of High-Speed Photography*

Refs: (for section on Electronic Amplification of Light Image & Techniques of Image Enhancement): 1a) B. Dudley & K. Henney, *Handbook of Photography*, McGraw-Hill, NY, pp 547-561 (1939) 2a) T.H. James & G.C. Higgins, *Fundamentals of Photographic Theory*, John Wiley, NY, p 57 (1948) 3a) A.E. Anderson et al, *HSP* **5**, 95 (1962), "The Astracon Tube and its Application in High-Speed Photography" 4a) M.L. Perl & L.W. Jones, *HSP* **5**, 98 (1962) "Very-High-Gain Image Intensifier Systems" 5a) R.A. Chippendale & J.R. Folkes, *HSP* **5**, 104 (1962) "Electronic Image Intensification" 6a) Z. Pressman, *HSP* **5**, 80 (1962) "High-Speed Films with Vigorous Development" 7a) M.Clouppeau, *HSP* **5**, 240 (1962) "Optical Contrastors"

Attention is drawn also to the following books, etc which provide valuable source material:

P. Fayolle & P. Naslin, *Photographie Instantané et Cinématographie Ultrarapide*, Editions de la Revue d'Optique, Paris, 1950

W.D. Chesterman, *The Photographic Study of Rapid Events*, Clarendon Press, Oxford, 1951

G.A. Jones, *High-Speed Photography*, Chapman & Hall, London, 1952

H.E. Edgerton & J.R. Killian, *Flash!*, Charles T. Branford, Boston, 1939 & 1954

A.A. Sakharov, *High-Speed Photography in Science & Technology*, Publishing House of Foreign Literature, Moscow, 1955

J.H. Waddell, *Photographic Motion Analysis*, Industrial Laboratories Publishing Co, Chicago, 1955

W.G. Chace & H.K. Moore, *Exploding Wires*, Plenum Press, NY, 1959; *ibid*, Vol 2, 1962

R.L. Aspden, *Electronic Flash Photography*, Macmillan Co, NY, 1960

C.H. Greenewalt, *Hummingbirds*, Doubleday, NY, 1960

W.G. Hyzer, *Engineering & Scientific High-Speed Photography*, Macmillan Co, NY, 1962

K.R. Coleman, "Ultra-high Speed Photography," *Reports on Progress in Physics*, **26**, 269-305, 1963

P.W. Holder & R. J. North, "Schlieren Methods," *Natl Physical Laboratory Notes on Appl Science*, No 31, HMSO, London, 1963

The bibliography on image dissection in high-speed photography by J.S. Courtney-Pratt

W.G. Hyzer, "Photographic Instrumentation Science & Engineering," Superintendent of Documents, US Govt Printing Office, Washington, DC, 1965

F. Früngel, *High-Speed Pulse Technology*, Vol I & II, Academic Press, NY, 1965

J. Rutkowski, *Stroboscopes for Industry and Research*, Pergamon Press, London, 1966

F. Van Veen, *Handbook of Stroboscopy*, General Radio Co, W Concord, Mass, 1966

The bibliography on Holography compiled by R.P. Chambers & J.S. Courtney-Pratt

R. F. Saxe, *High-Speed Photography*, The Focal Press, London, 1966

C.E. Miller, *Handbook of High-Speed Photography*, 2nd ed, General Radio Co, W Concord, Mass, 1967

K. Vollrath & G. Thomer, *High-Speed Physics*, Springer, Vienna, 1967

E.C. Cassidy et al, *Investigations of the Exploding Wire Process as a Source for High Temperature Studies*, (NBS Monograph 109), US Govt Printing Office, Washington, DC, 1968

A.S. Dubovik, *Photographic Recording of*

High-Speed Processes, Pergamon Press, London, 1968

K.S. Karsten, *Science of Electronic Flash Photography*, Chilton, NY, 1968

H.E. Edgerton, *Electronic Flash, Strobe*, McGraw-Hill, NY, 1970

The bibliography on high-speed photography (to 1960) compiled by Elsie Garvin, Eastman Kodak, Rochester, NY (Distributed at HSP 5)

Bibliography on High-Speed Photography 1960-1964 (Kodak Pamphlet P-27) compiled by Elizabeth W. Tapia, Eastman Kodak Co, Rochester, NY, 1965 (Distributed at HSP 7)

The bibliography on high-speed photography 1964-1970 compiled by Elizabeth W. Kraus, ed W.F. Walker, Eastman Kodak, Rochester, NY (Reprinted HSP 9, 548-595)

The volumes comprising the Proceedings of the International Congresses on High-Speed Photography, as described above

High Temperature Behavior of Explosives. See *Wenograd Test*

High Velocity Test Gun. A high-velocity gun facility, 87 feet long and with a 3.5-inch bore, is being used to study material behavior under extreme impact conditions. Impact velocity will reach a maximum of 8000 to 10,000 fps and will exert pressures of several million pounds per square inch upon experimental materials

Studies of the reaction of materials to extreme mechanical shocks are important in the design of components and systems which may experience severe impact. Experiments with different metals, alloys, ceramics, plastics and composites help engineers choose the ideal material for different applications under shock loading. They also provide the scientist with a more fundamental understanding of the materials themselves

The gun will be fired by igniting a charge of conventional artillery propellant weighing up to 20 pounds. The explosion propels a two-pound projectile (Sabot) and impactor through the barrel to the target. Since the experiments require precisely controlled impact conditions, the barrel must be honed to a tolerance of 0.0001 inch and aligned to 0.020 inch along its entire length before each test. As in similar guns, the bore is evacuated to about one micron

of mercury to prevent undesirable effects during impact

The test material may be mounted either on the Sabot or placed as a target at the muzzle. Instrumentation which will record data on material deformation will provide a resolution of a few billionths of a second in time and a few millionths of an inch in displacement

Refs: 1) Sandia Science News, Vol 2, No 4 (March 1969), Sandia Corp, PO Box 5800, Albuquerque, New Mexico 87115 2) G. Cohn, Edit, Expls & Pyrots 2 (11), 1969

Highways and Byways in Combustion. Title of a paper by D.T.A. Townsend, *JInstFuel* 27, 534-44 (1954) & *CA* 49, 2057 (1955). In this paper investigations of high-pressure explosions, flame propagation and combustion of higher-mol-wt hydrocarbons are reviewed

Hill Powder. Has been used for loading shells: NH_4 Picrate 43.0, K Picrate 53.5 & charcoal 3.5

Ref: Daniel (1902) 375

Himalaya's Explosives (Portugal). KClO_3 60-80, starch, charcoal etc 10-25, oil 4-10, metallic dust or powder 2-10, metallic oxides, or dehydrated CuSO_4 2-5%

Ref: M.A.G. Himalaya, *BritP* 22030 (1910) & *CA* 5, 3158 (1911)

Himley Explosive. KClO_3 45, KNO_3 35 & coal tar 20

Note: This explosive was prepared by impregnating the first two ingredients with tar dissolved in petroleum ether and allowing the ether to evaporate

Refs: 1) Daniel (1902) 375 2) Pérez Ara (1945) 216 3) Giua, *Trattato* 6, 400 (1959)

Hinde Explosive. NG 64.0, pulverized coal 23.0, Amm citrate 12.0, ethyl palmitate 0.25, Ca carbonate 0.25 & Na carbonate 0.50%

Refs: 1) Daniel (1902) 375 2) Giua, *Trattato VI* (1) (1959), 344

Hinshelwood, Sir Cyril, 70, retired since 1965 as professor of chemistry at Oxford University, died Oct 9, 1967 in London. Sir Cyril, who was a fellow of the Royal Society and its president

(1955-60), in 1926 published "Kinetics of Chemical Change," a subject in which he was already world-renowned. Continuation of his research into chemical kinetics later earned him the Nobel Prize in Chemistry (1956), along with N. N. Semenov of Russia. Sir Cyril was also noted for his breadth in fields other than science. He spoke six languages, including Chinese, and was a serious student of the literature of many countries, as well as being a painter. He served on many government advisory bodies and boards and was, for these contributions, knighted by King George VI in 1948. He was president of the Chemical Society (London) in 1946
Ref: *C&EN* 45, No 46, 63 (1967)

Hippuric Acid and Derivatives

Hippuric Acid, also called Benzoylaminoacetic acid, Benzoylglycine, Benzaminoacetic acid, $\text{C}_6\text{H}_5\text{CONHCH}_2\text{COOH}$, mw 179.19; colorless crystals, mp 188° (decomposes on further heating), d 1.371, sol in hot water, alc & eth.

Used in org synthesis & medicine

Refs: 1) *Beil* 9, 225, (107), [174] & {1123} 2) *CondChemDict* (1971), p 446

Hippuric Acid Azide or Hippuroyl Azide, $\text{C}_6\text{H}_5\text{CO.NH.CH}_2\text{CO.N}_3$; mw 204.19, N 27.44%; ndls (from benz or eth), mp 98° ; sol in alc, chl f & glac acet acid; sl sol in eth & cold benz; insol in w; was prepd by the action of Na nitrite on hippuryl hydrazine in warm water
Refs: 1) *Beil* 9, 247 2) T. Curtius, *Ber* 23, 3031 (1890)

Mononitrohippuric Acid,

$\text{O}_2\text{N.C}_6\text{H}_4\text{CO.NH.CH}_2\text{COOH}$; mw 224.17, N 12.50%. Three isomers are known:

2-Nitrohippuric Acid, crystals (from w), mp 190° (Ref 1)

3-Nitrohippuric Acid, ndls (from w), mp 166° (Ref 2)

4-Nitrohippuric Acid, colorless prisms (from w), mp $129-30^\circ$ (Ref 3)

Other props & methods of prepn are given in the Refs

Refs: 1) *Beil* 9, 374, [246] & {1478} 2) *Beil* 9, 383, [252] & {1517} 3) *Beil* 9, 395, [272] & {1726}

Mononitrohippuric Acid Azide,

$\text{O}_2\text{N.C}_6\text{H}_4\text{CO.NH.CH}_2\text{CO.N}_3$; mw 249.21, N 28.11%. Two isomers are known:

3-Nitrohippuric Acid Azide, yel powd, very un-

stable especially in daylight, decomp explosively above 74° if heated rapidly. Moderately sol in eth; sl sol in alc, chl_f & benz; insol in w; prepd from 3-nitrohippuric hydrazide & Na nitrite in glac acetic acid (Refs 1 & 3)

4-Nitrohippuric Acid Azide, yel powd, mp 70–72° (dec), deflgr on heating & explodes on heating in light; sol in eth; sl sol in alc & benz; insol in w; can be prepd from 4-nitrohippuric hydrazide & Na nitrite in HCl (Refs 2 & 4)

Refs: 1) Beil 9, (156) 2) Beil 9, (164)

3) T. Curtius, JPraktChem [2] 89, 490 (1914)

4) T. Curtius, JPraktChem [2] 94, 131 (1916)

3,5-Dinitrohippuric Acid,

(O₂N)₂C₆H₃.CO.NH.CH₂.COOH; mw 269.17, N 15.61%; ndls (from w) + H₂O, mp 181.4°; was prepd by treating glycine in a NaOH soln with 3,5-dinitrobenzoyl chloride

Refs: 1) Beil 9, <1937> 2) B.C. Saunders et al, BiochemJ 36, 368, 371 (1942)

4-Nitrohippuryl-aminoacetyl Azide,

O₂N.C₆H₄.CO.NH.CH₂.CO.NH.CH₂.CO.N₃; mw 306.24, N 27.45%; yel powd, mp 91–92° (dec), explodes on heating in the light; sol in NaOH; v sl sol in eth; was prepd by treating 4-nitrohippuryl-aminoacetyl-hydrazide, Na nitrite & HCl

Refs: 1) Beil 9, (163) 2) T. Curtius, JPrakt-Chem [2] 94, 134 (1916)

Hirschfelder-Sherman Calculation of Thermochemical Constants for Propellants. See A.M. Ball, "Solid Propellants Part One," Army Materiel Command Pamphlet AMCP 706-175, Washington, DC (1964), pp 7, 9, 10 & 53

Hispano-Suiza Gun. A 20mm aircraft gun used by the British during WWII and which proved to be a successful weapon. It was mounted either for firing thru the propeller hubs or from fixed mounts in the wings of an airplane

It was capable of delivering fire at the rate of 600-700 rounds per minute

Refs: 1) War Dept Tech Manual, TM 9-1901, p 323 2) J.A. Solomon, PATR 949 (1939)

(20mm CRA for Hispano-Suiza gun) 3) M.L. Mathesen, PATR 994 (1939) (20mm CRA for Hispano-Suiza gun)

4) M.L. Mathesen, PATR 1025 (1940) [20mm CRA for Hispano-Suiza

(Birkigt) gun] 5) A.B. Schilling, PATR 1627 (1946) (20mm HE CRA for Hispano-Suiza gun)

6) A.B. Schilling, PATR 1628 (1946) (20mm AP CRA for Hispano-Suiza gun)

HISTORY OF EXPLOSIVES, AMMUNITION AND WEAPONS

Introduction

Prior to describing history of explosives, it is desirable to say a few words about **cold weapons** which were used in wars many centuries before explosives or incendiaries were invented

Greener (Ref 7, pp 1-12) described such weapons and gave many illustrations as did Dupuy & Dupuy (Ref 69, pp 2ff)

Primitive *cold weapons* can be subdivided into two major categories: *shock* and *missile*, of which missiles could be operated by hand or mechanically. The earliest shock weapon was a heavy club, while the first missile was a stone or other heavy object hurled by hand. The next development in missiles was a *sling* (leather or string) which could be used for hurling smooth stones at longer distances than by hand. The stones were later replaced by lead balls. This weapon was used as late as AD 1572 and is still used by some savage tribes (Ref 69, p 2). In some weapons a stick was hurled and this, in turn, evolved into *darts* and *javelins*. In Australia appeared the *boomerang* which is still used for hunting. The *club* was modified by a number of ways, one of them was to attach a heavy stone or metal piece at its end. One such weapon was the Russian *palitsa*. The club with a sharp ax-like end was the *tomahawk* of the American Indians. The shock action counterpart of the javelin was the *heavy pike* or *thrust spear*. The spear with an ax-like end was *halberd* invented in 15th century and used since then by Vatican Guards

The *bow and arrow*, invented late in the Stone Age (ca 3500 BC), became an invaluable weapon for many centuries (See Vol 1 of Encycl, p A488-R) (Illustrated in Ref 7, p 3)

At the Bronze Age (sometime before 2000 BC), which followed the Stone Age and then later at the Iron Age (ca 1000 BC), the most important contribution was the adoption of metal for points of arrows & spears and also for edges and smashing surfaces of other weapons. The new weapons of metallic era were the *dagger* and the *sword*. They were probably first made by Assyrians (Ref 69, pp 2 & 8). Their *chariots* also were made of iron

The most important protective armor developed in ancient time was the *shield*, which was

usually held in the left hand or on the left arm, leaving the right arm free to wield a weapon

Emergence of historical China, as a small country around Yellow River Valley was around 1600 BC and the first known ruler was the Shung Dynasty (1523 to 1024 BC), which was followed by the Chou Dynasty (1027 to 500 BC). Their weapons were metallic but not as good as those of the Middle East. The same may be said about early Hindu weapons (Ref 69, pp 14–15). More about China is below

Substantial advances in tactics and doctrine of land warfare were made in the middle of the 6th Century BC by Cyrus the Great of Persia, but he used the same cold weapons as listed above with only slight modifications (Ref 69, p 16).

The Greeks at that time developed an Army outfit consisting of well trained soldiers known as *hoplites*. They carried a pike, a short sword and a shield (See Fig on p 17 of Ref 69)

A very important improvement in hurling missiles took place ca 400 BC when *ballista* (See Vol 2 of Encycl, p B5-L) and *catapult* (Vol 2, p C91-L) were invented. They are illustrated in Ref 7, p 6 and Ref 69, p 38). They hurled missiles up to 500 yards

In siege warfare invented after 350 BC by engineers of Alexander the Great of Macedonia were the *battering ram* and the famous *movable tower* (turns on wheel) (See Fig on p 39 of Ref 69). Other inventions were *mantelet*, *telenon* and *mural hook* (See Figs on p 40 of Ref 69)

The above described weapons were also used by Macedonians under Alexander the Great (b356, d323 BC) during their conquest of Europe and half of Asia. No new weapons were used, but they encountered in India a new weapon which will be described below

Next to Alexander, Julius Caesar (100–40 BC) was the outstanding director of siege operations, bringing systematic procedures to operations. Fig on p 83 of Ref 69 shows fort, tower, mound and mantelets designed by him, while on p 84 is shown *testudo*, which consisted of long shield raised and interlocked over the soldiers' heads and backs

One important cold weapon, the *crossbow* or *arbalist*, appeared in the 11th century (See Vol 1 of Encycl, p A477-L, where it is erroneously shown that it was invented in the 4th century).

It is illustrated on p 7 of Ref 7 and p 279 of Ref 69. It was used successfully by the Normans in invasion of England and one of the crossbow's arrows killed King Harold

In siege operations, one new weapon was introduced. This was the **trebuchet or mangonel**, a missile-hurling machine for battering fortifications or for throwing rocks or other objects over walls. Unlike the ballista and catapult, which obtd their power from tension or torsion, the propelling force of the trebuchet was provided by a counterweight (up to 10 tons) (Ref 69, p 281 and Fig on p 280)

One very important cold weapon appeared shortly before the introduction of Gunpowder (ca 1200 AD): the so-called *English longbow*, which was originally a Welsh weapon. It was claimed to have a range of up to 400 yards, maximum, and effective range ca 250 yards. It is described and illustrated on pp 5 & 12 of Ref 7 and on p 332 of Ref 69

Crossbow and longbow continued to be in service up to ca 15th century, competing with early firearms such as *handgun* (Ref 7, p 4) **History of Incendiaries, Fireworks and Black Powder up to the Middle of 19th Century.**

In addition to a brief history of Black Powder (also known as Gunpowder) given in Vol 2 of Encycl, pp B165-R to B168-L, we are giving here chronological listing in the manner done in a Japanese article by Dr Heizo Nambo (Ref 66). Its English translation was obtd thru the courtesy of Mr Gunther Cohn of the Franklin Institute, Philadelphia, Pa, 19103

We also used the following books, full titles of which are given in the list of Refs, which follows the description: Daniel (1902) (Ref 3, pp I to X, written by M Berthelot); Greener (1910) (Ref 7, pp 13–17); Marshall 1 (Ref 11, pp 11–50); Colver (1918) (Ref 12, pp 1–29, 496–505 & 563–64); Marshall 3 (1932) (Ref 20, pp 1–2); Stettbacher (1933) (Ref 21, pp 3–18); Newman (1943) (Ref 33); Dutton (1960) (Ref 58, pp 5 to 174); Dupuy & Dupuy (1970) (Ref 69, pp 332–33 and other pp listed in General Index on p 1322-R, under Gunpowder); Gorst (1972) (Ref 71, pp 5–12)

We are referring also to historical information given under individual items in Vols 1, 2, 3, 4, 5 and 6

Accdgd to Greener (Ref 7, pp 13 & 14):

"There seems little doubt that the composition of gunpowder has been known in East from times of dimmest antiquity. The Chinese and Hindus contemporary with Moses are thought to have known of even the more recondite properties of the compound. It is very possible that Alexander the Great *did* absolutely meet with fire-weapons in India, which a passage in Quintus Curtius seems to indicate".

The introduction of explosives into Europe followed the Mohammedan invasion. Greek fire, into the composition of which nitre and sulfur entered, was used prior to the fall of the Western Roman Empire (prior to AD 284)

It is known that prior to invention of explosives, incendiaries and fireworks were known, especially to Chinese and Hindus and later to Arabs and Greeks. That is why the chronological list given below starts with them:

1190 BC. This is the earliest date for incendiaries used in warfare listed in Ref 66, p 10. It concerns Trojan troops attacking Greek Navy with incendiaries

Note: The siege of Troy is listed in Ref 69, p 11-R as taking place ca 1184 BC

850 BC. In this year incendiaries were used in the battle of Mesopotamia, Irak (Ref 66, p 11)

Note: This battle is not listed in the book of Dupuy & Dupuy (Ref 69)

500 BC. Accdg to Dupuy & Dupuy (Ref 69, p 36-L), Sun Tzu, a native of the state of Ch'i (Modern Shantung) wrote the "Art of War", the first known military treatise, which provided valuable lessons for military men even today

500-470 BC. In the military tactics of Fan Li of Yuen (Che Chiang province), ballista of stone (Pao of stone) was described (Ref 66, p 11).

There were several ballistas of stone listed on p 25 of Ref 66. All of their names contained the word Pao, such as "Pao Che", "Tan Shao Pao", "Suang Fen Pao" and "Hu Tung Pao" (See Fig on the left side of p 38, Ref 69)

500-450 BC. In the military tactics of Sung Si in Wu of Kiang Su, soldiers used "pile of fire" and fireworks in the attack (Ref 66, p 11)

431-404 BC. Chemical Warfare. The earliest recorded use of chemical gas during the Peloponesian War (431-404 BC) when Spartans directed the fumes produced on burning of green wood mixed with tar and arsenic towards the besieged Athenians in towns of Plathaea and

Delium. Another use of poisonous gases was recorded in 187 BC when the Romans were driven from the town they besieged by means of fumes produced by burning feathers and coal. Poisonous fumes produced by burning green wood were used during Franco-Algerian War. More effective chemical agents were proposed during Crimean War (1853-56) and American Civil War (1861-65), but the real chemical warfare began in 1915 (qv) (See Vol 2 of Enycl, p C166 and also next item)

400 BC. Accdg to Dutton (Ref 58, pp 13-14), Spartans soaked blocks of wood in hot pitch & sulfur, piled them against the walls of enemy's fortresses, and applied the flame of a torch. As the walls were then built of wood the device was very effective. This served as a prototype of **wild fire** used much later. It seems that Spartans also invented a prototype of **flame throwers**. The original device was in the form of a huge iron caldron filled with burning pitch, sulfur & charcoal. This was mounted on top a high movable platform which the attackers moved up to the defenders' walls. The hollow trunk of a tree was then tilted to the edge of caldron, and air was pumped thru the trunk with a big bellows. Thus tarry-sulfurous smoke and tongues of fire were air-blasted upon the enemy to suffocate them. It is probable that **fire pots** were invented as early as that. They were earthenware jugs of various sizes, some thrown by hand, others for hurling by ballista or catapult. Filled with burning brews and acids, the jugs broke upon striking and showered their contents on the enemy. The most fiendish and destructive of the fire weapons was the **Greek Fire**, invented in the 7th Century AD

410-304 BC. Allied Navy of Sparta threw shells of sulfur, pitch and pine rosin by means of ballista to fire the Athenian Navy (Ref 66, p 11)

325 BC. Alexander the Great's troops which invaded India were defeated by means of "thunder bolts" thrown from the castle wall in Lahore by its inhabitants called Oxydarace (Ref 66, pp 4 & 11)

Note: Accdg to Greener (Ref 7, p 13), Alexander met with real "fire-arms" in India

249 BC. Spartans used incendiaries, consisting of small wood pieces impregnated with sulfur and pitch, in the battle of Plataena (Ref 66, p 11)
160-122 BC. Three components of Black Powder nitre (saltpeter), charcoal and sulfur were de-

scribed by Chinese alchemists in the Chuan Nan 'Tsu of Liu An (Ref 66, p 3)

220 BC & 160–122 BC. When several Chinese alchemists were separating gold from silver at low-temp reaction adding saltpeter and sulfur to the gold ore in the alchemist's furnace, they forgot to add charcoal in the first step. Trying to rectify their error they added charcoal in the last step. This resulted in tremendous explosion. This accident indicates that the mixture of saltpeter, sulfur & charcoal, exploded at that time, was similar to present Black Powder. No advantage of this accident was taken at that time (Ref 66, pp 3 & 29–31)

141–87 BC. In Robert Norton's "Gunner" published in 1628, it was reported that BkPdr was invented at the time of King Vitey (Wu Ti) of China and used in battles (Ref 66, p 11)

Note: More detailed description of this subject is given in Greener (Ref 7, p 17)

200 AD. Tseng Tsao of Wei at the San Quo Dynasty threw stones in the battle of Kuan Tu by means of the "thunder vehicle" (Ref 66, p 12), which was actually stone ballista (Ref 66, p 24)

222–235 AD. Alexander VI of Roman Empire called the "automatic fire" a ball (consisting of quicklime and asphalt) which spontaneously ignited on coming in contact with water (Ref 66, pp 6 & 12)

275 AD. Accdg to Greener (Ref 7, p 14), Julius Africanus mentioned "shooting Powder", but its compn was not given

350 AD. Aeneus of Rome put sulfur, pitch, incense, pine-rosin, and tow (crude flax fibers) into an oval wooden container, ignited the mixture and threw it on the decks of enemy ships (Ref 66, p 12)

668 AD. On the basis of advice given by Kallinikos of Heliopolis in Syria, an incendiary of secret formula known now as *Greek Fire* or *Sea Fire*. Fire was used by the Byzantine fleet to annihilate the Caliphate Navy (Ref 11, p 12)
Note: Accdg to Marshall 1 (Ref 11, p 12), Col Hime in his book listed here as Ref 4, came to the conclusion that, besides naphtha, sulfur and pitch, there must have been quicklime in mixture, which on coming in contact with sea water turned into slaked lime whilst raising the temperature to the point of ignition of sulfur. Greek Fire mixture was discharged from tubes or siphons located in the bows of the ships, against the

enemy. Marshall prep'd a similar mixture but was not able to ignite sulfur. He thought that the naphtha was ignited by a flame located at the orifice of the discharge tube (Ref 11, p 13)

Later the name "Greek Fire" was given also to combustible materials which were ignited and then thrown by ballista or other machines. These compns were solid masses of sulfur, pitch, naphtha, and other combustibles, and when saltpeter was discovered it also was included. Such mixtures may more correctly be called *Wild Fire*. Such mixts were used by Moslems in the Crusades (See under year 1250 AD) (Ref 11, p 13)

673–678. Moslem Arabs (of Caliphate) were defeated at the walls of Constantinople by defenders using Greek Fire (Ref 58, p 14)

683. In the battle of Mecca (Saudi Arabia), Kaiaba was fired by the incendiary missiles of Syrian Army (Ref 66, p 13)

690. Accdg to Greener (Ref 7, p 14), the Arabs or Saracens are reputed to have used Gunpowder at the siege of Mecca; some writers even affirm that it was known to Mahomet. Marcus Graecus described in "Liber ignium" an explosive composed of 6 parts saltpeter and 2 parts each of charcoal and sulfur

716–718. The Arabs of Caliphate again appeared before Constantinople with 1800 ships, but again were defeated by Greek Fire (Ref 11, p 12)

904. Accdg to Greener (Ref 7, p 14), it was recorded that Gunpowder was used by the Saracens at Thessalonica

904. The Caliphate troops (Baghdad, Irak), when attacking Salonica (Greece), threw ceramic pots charged with a mixture of pitch, pine rosin, and quicklime over the heads of enemy troops to suffocate them (Ref 66, p 13)

904. Before the end of Tang's rule, Cheng Fan attacked Yu Chang by means of "flying fire" hurled by ballista (Ref 66, p 13)

940. The Chinese device, called "fire pao", consisted of ballista throwing a "fire ball", made of explosive similar to BkPdr, tied to the top of an arrow (Ref 66, p 13)

941. The East Roman (Byzantine) Navy poured from the tube or syphon located at the boat's stern a liquid ("sea fire") made from naphtha, quicklime and sulfur, over the Russian ships attacking Constantinople (Ref 66, p 14)

1000. Tung Fu of Sung Dynasty invented "fire arrow", "fire ball" and "fire dart rocket"

(Ref 66, p 14)

Note: In the book of Dutton (Ref 58, p 5), it is stated that during Sung Dynasty (960–1280) some unknown man described the invention of *To-lo-tsi-ang* which consisted of a long bamboo tube in which a handful of explosive similar to BkPdr was placed. When set on fire a strong flame came out accompanied by ejection of some grains of pdr (to a distance up to 150 paces) and creating thunderous noise similar to that of "paos"

1002. In the reign of Chen Tsung of Sung, Lo Yung Si invented a "portable ballista" (Ref 66, p 14)

1040. At the time of Chen Tsung of Sung, Pe Sung built a Gunpowder Plant in Pien King (Haifeng, Honan) (Ref 66, p 14)

1043. Russian fleet was defeated at the siege of Constantinople by means of Greek Fire (Ref 11, p 12)

1045. Pe Sung Govt issued permit to Wu Ching Tsung Yao for manuf of "firing arrow", "thorn fire ball", and "poisonous smoke ball" (Ref 66, p 14)

Note: Brief description of these and other Chinese devices is given in Ref 66, pp 32–35 & 41)

1045. Accdg to Nambo (Ref 66, p 38), the compn of powder for "fireballs", as described by Wu Ching of Sung, was: saltpeter 48.5, sulfur 25.5 & other ingredients 26.0%

1045. Accdg to Nambo (Ref 66, p 38), the compn of powder for "thorny fire balls", as described by Tsung Yao of Sung, was saltpeter 50.0, sulfur 25.0, charcoal 6.25 & other ingredients 18.75%, while the compn of powder for "poisonous fire balls" was saltpeter 38.5, sulfur 19.25, charcoal 6.4 & other ingredients 35.85%

1073. Accdg to Greener (Ref 7, p 14), Gunpowder was used by King Salomon of Hungary at the siege of Belgrade

1098. Accdg to Greener (Ref 7, p 14), in a sea conflict betw the Greeks and Pisanians, the former had fire-tubes fixed at the prows of their ships

1096–1099. In the battle of Nice of the 1st Crusade, the Caliphate troops threw burning pitch and fatty balls. They also shot fire arrows with pitch, sulfur and tow from the walls of Jerusalem (Ref 66, p 14)

1126. In a triple war among the Sung, Kin and Mongols, explosive arms were used, first by Sung

and then by others. The devices included: fire arrow, radiation firearm, fire burster, fire lance, fire ball, thunder ball, etc. They are described in the paper of Nambo (Ref 66, p 14)

1129. It was suggested equipping Chinese fleet with weapons such as ballista, fire arrow, etc (Ref 66, p 15)

1132. Li Heng besieged Te An using long ladders. The General of Defense Army used 20 fire lances, long bamboo tubes charged with Gunpowder (Ref 66, p 15)

1135. During Chinese Civil War, Kin's fleet used thin, brittle pottery bottles charged with quicklime, poison and iron pickles (?). The resulting smoke injured the eyes of enemy (Ref 66, p 15)

1147. Accdg to Greener (Ref 7, p 14), Arabs used firearms against the Iberians (Spanish)

1169–1189. In the reign of Haiao Tsung of Nan Sung, true fireworks, Yan Huo, made their debut. They were similar to those used today (Ref 66, p 16)

1214. When the Mongols captured Chung Ching, Kin moved his capital to Pien Ching and the Mongols came into possession of techniques for manuf of Gunpowder and firearms (Ref 66, p 16)

1218. Accdg to Greener (Ref 7, p 14), there was artillery at that time in Toulouse

1218–1258. In the reign of Nan Sung, Gunpowder and fireworks were manufd in quantity sufficient not only for local consumption but also for export, mostly to Caliphate country (Iraq) (Ref 66, p 19)

1220. Accdg to Sancho (Ref 30, p 254), Moors used machines for hurling stones

1221. During the siege of Chin Chou, Kin arranged 13 sets of ballistas to shoot "iron bombs" into the castle. The iron bomb (Tie huo pao), was cast, hollow ball, 6cm in diam, filled with Gunpowder and equipped with a fuse cut to the desired length and ignited before launching the bomb (Ref 66, p 16)

1221. When Chingis (Chenghiz) Khan and his Mongolian troops invaded Europe and Russia, they threw stones by crossbow ballistas to break fortification walls; also used poisonous powder flasks (Du huo fou), fire arrows (Huo jian) and fire stone balls (Hua pao). Such weapons were used at the battle at Amu Dariya river against Khorasan Empire (present Russian

Turkestan) and in other battles (Ref 66, p 18)

1225. Saltpeter became known in Europe (Ref 11, p 21)

1231. When Mongolian general Touloui captured Hochung Fu, the Chinese garrison escaped by crossing the channel on old ships; then they destroyed the ships by iron bombs (Chen tien lei) (Ref 66, p 16)

1232. During the 2nd attack by Mongols on Nan Ching, Kin used iron bombs (Chen tien lai) charged with powder and provided with a fuse. They flew off a long way to burst. He also used flying fire lances (Fei huo quiang) (Ref 66, p 16)

1232. Accdg to Marshall 1 (Ref 11, pp 14–15), in the Chinese chronicle "Tun Klang Kang-mu", translated into French in the Journal Asiatique for Oct 1849, there was a description of a weapon used at the siege of Pien King (now Kai-fung-fu). It was "Ho-pao" or "Fire-pao", called "Tchin-tien-loui", translated as "thunder that shakes the sky". The device consisted of an iron pot filled with "yo" (medicine). As soon as light was applied the "pao" rose and fire spread in every direction. Its noise resembled that of thunder and could be heard more than 100 lis (33 Engl miles). It could spread fire over more than a third of an acre. This fire even penetrated the breast plates on which it fell. These "bombs" were probably thrown by ballista

Note: This item described in Marshall (Ref 11) is identical with that described by Nambo (Ref 66, p 16)

1232. Mongolian soldiers constructed with ox-hides a passage to the ramparts of Nan Ching castle. They commenced to sap the walls and made holes in them in which they could remain sheltered from the besieged men above. Then the besieged Chinese hung "fire paos" on the chains down the face of the wall. When the "paos" reached the levels of hidden Mongols, they were ignited to explode, thus killing the invaders. In addn the besieged used "Fei ho tiang" (arrows of flying fire), which consisted of arrows with attached substance which was susceptible to taking fire in flight. While flying, such arrows spread flames over a width of 10 paces. These Chinese devices were much feared by Mongols (Ref 11, p 15 & Ref 66, p 17)

Note: Marshall thought that the effects of the

above Chinese devices could hardly have been produced without the use of saltpeter, nor the great noise without an explosive (Ref 11, p 15)

1233. In the battle of Nan Ching, Kin defeated the Mongols by means of "flying fire lances" (Huo quiang), which were tubes, 0.8m long made of 16 piled sheets of strong paper charged with an incendiary mixture and porcelain fragments. On ignition the flame shot no less than 3 meters (Ref 66, p 17)

1234. Allied Army of Mongols and Sung against Kin used stone fire balls, called "Huo pao". Kin was defeated and committed suicide (Ref 66, p 17)

1241. When the Mongolian Khan Bhatu (Batyi) invaded Russia and Western Europe, and went as far as Nahlstadt near Lignitz, his troops used poisonous smoke bombs (Ref 66, p 18)

1241. When Bhatu troops besieged castle Olmütz in Moravia (present Slovakia), they used fire arrows to burn the temple (Ref 66, p 19)

1247. Accdg to Greener (Ref 7, p 18), Seville had been defended by a "cannon throwing stones"

1249. English Monk Roger Bacon (1214–1292 or 1294) gave in his book "Operibus Artis et Magie" the compn of Gunpowder as saltpeter 7, sulfur 5 and charcoal 5 parts (Ref 66, p 17)

Note 1: Accdg to Greener (Ref 7, p 14), it is presumed that Bacon obtd his knowledge about BkPdr from the Treatise found in the Escorial (Spain) Library collection

Note 2: Accdg to Marshall (Ref 11, p 17), Bacon published ca 1250 his "Opus Tertium" and a part of its translation (from Latin) was published by Col Hime in the Journal of the Royal Artillery, July 1911

1250. Compn of Roger Bacon's Gunpowder is given in Ref 11, p 26 as: saltpeter 41.2, charcoal 29.4 & sulfur 29.4%

1250. It was mentioned under the year 668 AD as the incendiary which Marshall proposed to name *Wild Fire*. Such incendiaries were used by Arabs against the Crusaders. Thus Joinville, participating under St Louis in the disastrous Sixth Crusade wrote that this incendiary device came flying thru the air like a winged long-tailed dragon, about the thickness of a hoghead, with the report of thunder and velocity of lightning; and the darkness of the night was dispelled by this deadly illumination. These devices terrified the crusaders, because they believed them to be

the products of Devil. Fortunately the damage was only slight (Ref 11, p 13)

1257. In the reign of Li Tsung of Sung, the invading Mongolian troops were held back by means of big supply (found in Chinese Arsenals) of iron bombs (Tie huo pao) and flying fire lances (Huo quiang) (Ref 66, p 17)

1259. In the battle of Niebla, Spain the Moors (Arabs) threw (by means of ballista) stones and filth and also "missiles with thunder" (Ref 66, p 19)

1259. In the battle of Melilla, Morocco, the Moors used cannons and firearms (Ref 66, p 19)
Note: It is more probable that they threw "Wild Fire" missiles by means of ballistas

Note: In the opinion of Marshall 1 (Ref 11, p 13), it is probable that the "missiles with thunder" used by Moors in Spain and Morocco were the same as used in 1250 AD by Arabs against the Crusaders of Saint Louis (See above under the year 1250 AD)

1259. Accdg to Marshall 1 (Ref 11, p 15) and Dutton (Ref 58, p 5), it was stated in Chinese annals that in the 1st year of Kai-King was made an appliance called "Tho-ho-tsiang", meaning "lance with violent fire". A nest of grains of powder was introduced into a long bamboo tube, and when the pdr was lit the flame shot forth from the tube with a noise like that of a "pao", which could be heard at a distance of about 500 paces (Dutton gives 150 paces). It was a device resembling current Roman candle

1259. In the reign of Li Tsung of Sung Dynasty was invented "fire lance with projectile" (Shi huo quiang). It consisted of a bamboo tube charged with powder and contg on top of it a ball serving as a projectile. When the powder was ignited the flame came out and the ball flew away. It was accompanied by a loud noise which was heard at a distance of 270 meters (Ref 66, p 17)

Note: It is not stated whether the lower end of bamboo tube was open or closed. In case of closed tube it was necessary to attach it to some firm object because the recoil will kick it in reverse direction, and in this case it could be considered as a prototype of modern rocket. Similar bamboo weapons were used by Arabs (Ref 58, p 9)

1268. In order to relieve the 5-year siege of Sing Yang by Mongolian troops, 3000 Chinese

were sent on 100 boats and they routed the Mongols by means of fire lances and other fire arms (Ref 66, p 18)

1273. Accdg to Greener (Ref 7, p 18), Abou Yuesof used cannon firing stone shots at the siege of Sidgil-messa

1274. When Chinese troops under Yuang landed at the Hakata Bay (Japan) they shot iron bombs (Tie pao), which surprised and defeated Japanese troops. They called the bombs "teppo" (Ref 66, p 20)

1277. When Ching Chiang fell, the defending general of Sung fired a large cannon (Huo pao). This destroyed the castle walls and burned to death a 200-man garrison (Ref 66, p 18)

1279. In the Naval battle near Asmen (Huan Tang), betw Chang Shih Chieh of Sung and Chang Hung Fan of Yuan large cannons (Huo pao) were used by both sides. The Navy of Sung was defeated (Ref 66, p 18)

Note 1: Chronological list given in the article of Nambo (Ref 68) does not go later than 1279 AD

Note 2: Accdg to Marshall 1 (Ref 11, p 18), the Chinese do not appear to have developed expls beyond this point, or to have made the next step, namely of causing the pdr to throw a heavy metal projectile instead of a ball of fire. This step could only be taken by a nation which was at once progressive and well acquainted with the working of metals

Note 3: Marshall forgot to mention that progress in China was impeded by Chinese Civil Wars and Mongolian invasion

Prior to 1300. The Arabs introduced saltpeter in their Greek Fire and other incendiaries. In Europe saltpeter was more scarce than in Africa and Asia (Ref 11, p 17)

1300. In the "Liber Ignium" of Marcus Graecus, which was probably translated into Latin from an Arabic source ca 1300, were several references to incendiaries used by Arabs. One of them "ignis volatilis" (flying fire) consisted of resin 1, sulfur 1 and saltpeter 2 parts, dissolved into a hollow reed or wood. This was in the opinion of Marshall 1 (Ref 11, p 17) an incendiary ("wild fire")

The compn listed on p 18 of Ref 11 consisted of sulfur 1, vine or willow charcoal 2 & saltpeter 6 parts. The ingredients were rubbed down together on a marble slab and put into a case, which was short & strong and filled only half-full

when it was desired to make a loud noise. On the other hand, a thin, long container, known as "tunica" was completely filled with the above powder and flew on being lit. This "flying tunic" was an imperfect rocket (Ref 11, p 18)

14th Century, Early. Accdg to Greener (Ref 7, Chap IV, "Early Hand Fire Arms", pp 44-51): 'No distinction can be drawn between the small cannon or "crush-gun" of the fourteenth century and the earlier fire-arms. A pyrotechnical piece developed into a variety hand weapon and used for military purposes, especially for causing disturbances among troops, frightening horses and stampeding cattle, was employed by Eastern nations and by Arabs in Northern Africa". Such a device which was also used by incendiaries, pillagers, and outlaws is shown in Fig on p 44 of Ref. The gun consisted of an iron tube ca 6 ft long, covered with two hollowed pieces of wood, and bound round with hemp, hair or leather. The tube was fastened to a stick, which could be held under arm or placed on a shoulder. The compn of the charge resembled a Roman candle

14th Century. Accdg to Marshall 1 (Ref 11, p 25), some early powder makers added camphor, sal ammoniac and gum to their Gunpowder to prevent its crumbling. In the "Codex Germanicus" of the 14th Century, the following recipe is given: If you want to make a good, strong powder, take 4 lbs of saltpeter, 1 lb of sulfur, 1 lb of charcoal, 1 lb of "salpratica" (mixt of saltpeter, camphor & ammonia dissolved in alcohol), 1 oz of sal ammoniac and one twelfth part of camphor. Pound it all together with some alc until well mixed and then dry in the sun. When "corning" of powder was invented in 1425, there was no necessity to incorporate camphor

1304. Accdg to General Fuller (Ref 50), this is the earliest year when a weapon resembling a cannon was documented. It was in an Arabic manuscript. Accdg to Dutton (Ref 58, p 6), it was preserved in the Asiatic Museum at StPetersbourg, Russia, a fragile and faded Arabic parchment, which presents a sketch drawn by Shems Eddin Mohammed in 1304 of a new weapon. It is described as a "spear that hurls arrows at the enemy. The spear was a bamboo tube which had been reinforced by metal bands. Among flame and smoke, an arrow is shown on the sketch flying from the muzzle. Marshall 1 (Ref 11, p 19) said: "There is a manuscript in Asiatic Museum

at Petrograd probably compiled by Shems ed Din Mohammed about 1320, which shows tubes for firing off both arrows and balls by means of powder"

Note: It seems that the manuscript listed by Marshall as of 1320 is the same as described by Fuller and Dutton as of 1304. It is also probably the same manuscript as listed by Sancho (Ref 30, pp 253-54), saying that the manuscript written in 1304 in Arabic, discovered by Reinaud & Fave in a library at StPetersbourg, contd the following compn: saltpeter 10 drachmas, charcoal 2 & sulfur 1.5, called *Medfraa*

Note: Historical description of development of cannons is given in Vol 2 of Encycl, pp C26 to C29

1308. Accdg to Greener (Ref 7, p 18), Ferdinand IV of Castille employed guns (marquenas de trueñas) in the siege of Gibraltar

1308. A cannon was used for defense of the castle of Heyer on the Rhein. The castle was destroyed and the cannon remained in its ruins until it was found in 1560 (Ref 7, p 18)

1310. Accdg to Greener (Ref 7, p 18), firearms were used by the English at the siege of D'Eu

1311. Accdg to Greener (Ref 7, p 18), Ismail attacked Bazas in Granada, Spain, with "machines throwing balls of fire, with noise like thunder"

1313. Accdg to Col Hime (Ref 10, p 2), a weapon resembling cannon was invented by an unknown German monk. The weapon was used in 1314 at the battle of Bannockburn [Quoted from Marshall 3 (Ref 20, p 1)] (See also Vol 2 of Encycl, p C26)

1313. Accdg to Greener (Ref 7, p 18), the city archives of Ghent (Belgium) stated that the city was in possession of a small cannon

1313 (About). Accdg to Newman (Ref 33, pp 71 & 75), the gunmakers of Flanders constructed (no year is given) the famous *Giant Bombard of Ghent*, also known as "Dulle Griete". Its caliber was 25 inches, while its length was 40 feet

Note: Accdg to Greener (Ref 7, p 27), Sir John Froissart stated that this gun was used by D'Ardevelde at the siege of Oudenarde (no date is given)

1320. Accdg to Greener (Ref 7, p 17), Berthold Schwartz, a monk of Friburg in Germany, studied the writings of Bacon regarding explosives, and manufactured gunpowder while experimenting. He has commonly been credited as an inventor, and at any rate the honor is due to him for

making known some properties of gunpowder; its adoption in Central Europe quickly followed his announcement, which is supposed to have taken place about 1320. It is probable that gunpowder was well known in Spain and Greece many years prior to its being used in Central Europe

1323. Accdg to Sancho (Ref 30, p 254), "balls of fire with noise" were used at the siege of Baeza (or Baza), Spain

1324. Accdg to Marshall 3 (Ref 20, p 1), the town of Metz, France appears to have cannons at that time

1325. Accdg to Greener (Ref 7, p 18), in the records of Florentine Republic was stated that two officers were ordered to manuf cannons and iron balls for the defense of castles and villages

1326. Accdg to Sancho (Ref 30, pp 254-55) in Florence there were used cannons of bronze to shoot iron balls and the existence of plant manufg cannons is mentioned in chronicles

1326. Accdg to Marshall 1 (Ref 11, p 19), in an illuminated manuscript entitled *De Officiis Regum*, written in Latin by Walter de Millemette and preserved in Christ Church Library, Oxford, England, there is a drawing reproduced here of a rudimentary gun shaped like a bottle, showing a dart used as a missile and a man applying a fire to a touch hole. The same illustration is reproduced in the book of Dupuy & Dupuy (Ref 69, p 333). The beautiful manuscript (in color) was seen by the senior author of this Encycl during his trip to England

Note: Accdg to Dutton (Ref 58, p 32) this type of weapon was made of brass

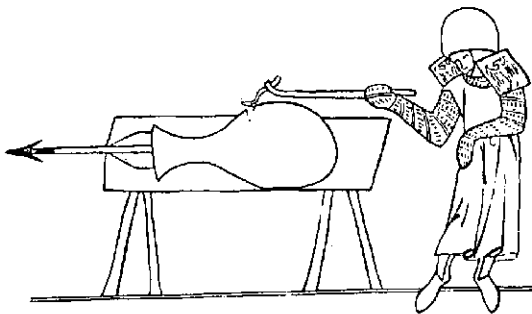

Early cannon

1326. Accdg to Sancho, the French attacked Gravelines using cannons & bombards (Ref 30, p 255)

1326. Accdg to Marshall 1 (Ref 11, p 19), the Republic of Venice ordered the provision of metal cannons and iron bullets for the protection of castles and villages. Accdg to Sancho (Ref 30, p 255), the Venetians took Guera employing cannons

Note: Definition of term "cannon" is given in Vol 6 of Encycl, under GUN. It is preferred to that given in Vol 2 under CANNON. We are using the word "cannons" for plural in order to avoid confusion

1327. Accdg to Greener (Ref 7, p 19), John Barbour wrote in 1372 that in 1327 at the battle of Warewater, the Scotch first saw the firearms

1330. Accdg to Sancho (Ref 30, p 254), the first firearms appeared in France during the reign of Philippe de Valois (1293-1350)

1331. Cannons were used by Moors at the siege of Alicante (Spain) to open a breach in the wall (Ref 11, p 19 & Ref 30, p 254)

1338. Accdg to Greener (Ref 7, p 18), the English contemporary record mentions that King's ships "Bernard de la Tour" and "X'ofre de la Tour" were equipped with cannons and handguns

1338. Accdg to Nambo (Ref 66, p 39), the compn of French powder of unknown use was: saltpeter 50, sulfur 25 & charcoal 25%

1338. Accdg to Greener (Ref 7, p 19), powder and cannons were provided for the protection of the ports Harfleur and l'Heure (France) against Edward III

1339. Accdg to Marshall 3 (Ref 20, p 1), there was mention of six brass "gonnes" in the London Guildhall, together with "peletae" weighing 4.5 lbs and 32 lbs of powder, showing that the darts used in the very earliest guns were replaced by small balls

1340. Sir John Froissart in "Chronicles of England, France and Spain", Bk I, Chap 72, stated that Scots used cannons in the siege and capture of Stirling and in 1340 or 1341 Gedymin, Grand Duke of Lithuania was killed by a cannon ball at the fortress of Walona, which was being besieged by the Germans. It is evident that at that time the guns were in use for siege warfare but they were not sufficiently mobile for the field (Ref 20, pp 1-2)

14th Century. Accdg to Nambo (Ref 66, p 39), the compn of German powder of unknown use was: saltpeter 66.7, sulfur 22.2 & charcoal 11.1%. A slightly different compn is given in Marshall 1 (Ref 11, p 31). It was: saltpeter 66.6, charcoal 16.6 & sulfur 16.6%

1340. Accdg to Colver (Ref 12, p 496), solid spherical projectiles for cannons started to replace the arrow-shaped projs. The material was stone, bronze or iron

1340. In two frescoes in the church of former monastery of San Leonardo in Leccetto, near Siena, painted by Paolo del Maestro Neri, are shown: a large cylindrical cannon discharging a spherical ball, and several hand guns (Ref 11, p 19)

1341. Accdg to Sancho, the Scots took from the English the town of Stirling employing artillery (Ref 30, p 254)

1342. Cannons were used by Moors in the defense of Algeciras (Spain) against Don Alfonso XI de Castilla (Ref 11, p 19 & Ref 30, p 254)

1342. Accdg to Marshall 1 (Ref 11, p 19), Counts of Derby and Salisbury, who were present at the above battle of Algeciras, supposedly introduced guns and gunpowder into England. In the following years there are several refs in the accounts of the Wardrobe of Edward III of payments for saltpeter for manuf of Gunpowder

Note: Accdg to Greener (Ref 7, p 15), ingredients for Gunpowder manufd in England were usually separately purchased abroad and mixed when required. Mr Oliver of Boklesberry appears to have been one of the first dealers in Gunpowder (Ref 7, p17)

1344. Accdg to Dutton (Ref 58, p 32), Edward III of England was the first to add cannons to his Army. There were at least two clumsy bronze cannons with him when he crossed the channel to France in the War against Philippe de Valois

1346. Accdg to Dutton (Ref 58, p 34), the battle of Cr cy, fought on August 26, 1346 was won by English *longbows*, but it is not known if the cannons took action, because some accounts do not mention them at all

Note 1: Accdg to Greener (Ref 7, p 18), John Cook, a clerk of the King's wardrobe, to which department the arms and munitions of war belonged, stated that 912 lbs of saltpetre and 846 lbs of sulfur were provided for the use of the army in France; later in the year, before

Calais, he obtained a further supply. That fire-arms were used by the English at Cr cy in 1346 is a well ascertained fact

Note 2: Accdg to Marshall 3 (Ref 20, p 2), it was improbable that cannons were used at the battle of Cr cy, because at that time no light weapons existed but there were only heavy siege cannons

Note 3: Gen Fuller stated in Vol 1 of his book (Ref 50) that accdg to Sir Charles Oman the weapons used at Cr cy were *ribaudequins*, which were invented in 1339 and may be considered as ancient machine guns. They consisted of several iron tubes clamped together to form a device resembling a multiperforated cylinder. The tubes could be fired separately or simultaneously

1347. Accdg to Dutton (Ref 58, p 39), cannons were definitely used by the British at the siege of Calais, France. They also had *ribaudequins*, mentioned above under Note 3

14th Century, 2nd Half. A brief description and illustrations of 14th century cannons are given in Greener (Ref 7, pp 20-5). The illustrations include: p 21 - Early breech-loading cannons; p 22 - Iron breech-loading cannon, Cast breech-loading cannon, Italian bombard, and Early English breechloader; p 23 - Italian muzzle-loading cannon called "Cerbotain"; p 24 - German Artillery; p 25 - Elbow-joint bombard

1350. Bullets. The primitive bullets, which were either stones or metallic slugs of irregular shape were gradually replaced by cast spherical lead slugs (balls) which were smaller in diam than the bores of the guns which at that time had irregular calibers. When the calibers were standardized the bullets were made of the same caliber as the barrel. All early bullets were loaded thru the muzzle on top of a wad previously placed on top of a charge of BkPdr. There were no cartridges until the time of Gustavus Adolphus, born in 1594, King of Sweden, 1611 to 1632, when a successful paper cartridge was invented. The first elongated bullet was invented in 1823 by the British Officer Norton. The other elongated bullet was invented in 1836 by W. Greener, the famous Brit gunmaker. More detailed description of historical development of Bullets is given in Vol 2 of Encycl, pp B324 to B331

1350. Accdg to Nambo (Ref 66, p 39), the compn of British Gunpowder "Arderne", used at that time was saltpeter 66.7, sulfur 11.1 &

charcoal 22.2% (See also Ref 11, p 26)

1360. Accdg to Marshall 1 (Ref 11, p 23), as quoted from paper of F.M. Feldhaus in SS 4, p 275 (1909), the Rathaus at Lübeck was destroyed by fire thru the carelessness of Gunpowder makers

1372. Accdg to Feldhaus (see above) there was no mention of Gunpowder or firearms in the archives of Augsburg before this year, although Berthelot claimed that a powder mill existed there since 1340 and that a mill was at Spandau in 1344 and at Liegnitz in 1348 (Ref 11, p 23)

1378. Accdg to Greener (Ref 7, p 22), the earliest cast cannons made of copper and tin were produced by a founder named Aran at Augsburg, Germany. They were primitive breech-loaders, built up of iron strips surrounded by iron rings — a method which continued for several centuries (See illustrations on p 22 of Ref 7)

1379. Cannons and bombards were employed at the siege of Puy de Guillen in Perigord (Ref 30, p 254)

1379. The French possessed at Cambray 5 iron cannons & 5 of other metal (Ref 30, p 254)

1381. Accdg to Greener (Ref 7, p 45), the first account of hand-cannon being used in Germany was in 1381, when the town of Augsburg supplied thirty men armed with them to the contingent of the Swabian towns in their war against the South German nobles

Note: In the same book it is stated that hand guns were used in the 14th century by French, Italians and Netherlanders (See also Vol 2 of Encycl, pp B324–B325)

1382. Accdg to Gorst (Ref 71, p 6), the first recorded use of Gunpowder and artillery in Russia was in 1382 at the defense of Moscow against the invading Mongols (Tartars)(called by Russians Tatars), under the Khan Takhtamysh

1386. Accdg to Greener (Ref 7, p 49), handguns were used in Padua, Italy

1388. The fire-arm of Rouen was, accdg to Greener (Ref 7, p 20), a small iron-forged weapon. It was shooting feathered iron arrows, loaded from muzzle, propelled by a charge of Gunpowder, which was put in a separate movable breech-block or chamber (See illustrations on pp 21 & 22 of Ref 7)

1389. Accdg to Sancho (Ref 30, p 255), the manuf of firearms and Gunpowder started in Russia

1391. Accdg to Fuller, Vol 1 (Ref 50), solid iron balls partly replaced stones as cannon missiles, but hollow iron projs filled with Gunpowder (to act as an explosive) were not invented (in Holland) until the 16th century (Greener, 1st edn, Ref 2, p 27)

14th Century, Late. The smallest among the early fire-arms were the Italian **bombards**, one of which is shown in Fig on p 23 of Ref 7. The bombards were muzzle-loading, and had the powder chamber of much smaller caliber than the forward portion. This fore part was usually more or less tapered so that shot of different diameter might be fired

Another early weapon was the “bombardo cubito” or “elbow-joint gun” which is described and illustrated on p 25 of Ref 7

Large cannons were made at a very early date, even if they were never used. The fact that such a weapon was possessed by a town, possibly terrorized opponents. One of such huge weapons was the “Faust Bucleae” of Frankfurt, made in 1399 and used at the siege of Tannenburg Castle (Ref 7, p 27). Method of manuf of Gunpowder at the end of 14th century is shown in illustrations on p 16 of Ref 7. It is briefly described on p 24 of Marshall 1 (Ref 11)

1399. Accdg to Sancho (Ref 30, p 255), the English used 10 cannons during the siege of St Malo (France)

1400. Cristina de Pizana employed “balls of fire” and other incendiary projectiles (Ref 30, p 255)

15th Century, Early. Accdg to Dutton (Ref 58, pp 39–40), by 1400 iron cannons, bound by iron hoops to keep them from bursting, and iron cannon balls were coming into use. At the end of the 14th century a **handgun** was invented which weighed 10 lbs and fired lead shots. One man carried it mounted on the stand and aimed at the enemy. A similar gun but of 16th century is shown in Fig on p 54 of Greener (Ref 7). A cavalry handgun, called **petronel** is shown on p 46 of Greener and a larger *semi-portable* gun on p 42. Some lighter hand guns did not need any stand — they could be fired from the shoulder, as shown in Figs on pp 45 & 51 of Greener. A simpler hand gun is shown and briefly described in Vol 4 of Encycl, p D755-R with Fig on p D755. Its stock was a long piece of wood held under the arm of the soldier. The first improvement of hand gun was the introduction of bent stock and

the resulting gun was known as **arquebus**. It is briefly described in Vol 1 of Encycl, p A488-L and illustrated on p 54 of Greener (Ref 7). This weapon was known accdg to Newan (Ref 33, p 33) before 1503, although Dutton (Ref 58, p 60) claimed that it was invented in 1521

Each hand gun or arquebus was provided at the rear, closed end (breech) with a *touch hole* serving for igniting by means of a *match* of BkPdr proplnt located in the barrel (See Vol 2 of Encycl, p C73, and Vol 4, p D753-R). When the match was mounted later (after 1460) on a S-shaped lever, called "cock", the device became known as *matchlock* (See also under years 1460-1480)

1410. Accdg to Gen Fuller 2 (Ref 50), *canister* or *case-shot* was invented in 1410 and although it was partly replaced by *shrapnel* (See Ref 11, p 30), it is still used (See Vol 2 of Encycl, pp C24-R & C25-L)

1413. Accdg to Greener (Ref 7, p 27), Mahomet II. of Ottoman Empire used at the siege of Constantinople a giant cannon which was 48 inches in diameter and fired stones weighing 600 lbs

1415. Accdg to Marshall 1 (Ref 11, p 33), the English used at the siege of Honfleur, France, mines charged with Gunpowder for blowing up the walls of fortifications

1418. Accdg to Greener (Ref 7, p 33), this seems to be the first year when **mortars** were used. It was in defense of Cherbourg, that these weapons hurled red-hot shot. Three illustrations of mortars are on pp 35, 36 & 37 of Greener. Current mortars are briefly described in Vol 2 of Encycl, p C27-R, under CANNON. Mortars were also used at the siege of LaFère in 1580 and at Gibraltar in 1780

1419. Accdg to Dutton (Ref 58, pp 41 & 46), the earliest cannons were not mounted on wheels but were just dragged by beasts or men over the roads or fields. For the 1st time in history cannons were not put on wheeled gun carriages, but on stout four-wheeled farm carts. This was done by Jan Žiska (pronounced Zhiska) in 1419 during the insurrection of Czechs against Sigismund of Germany who was the ruler of country known as Bohemia at that time. Zhiska's supreme stroke was a big "waggon-fort", called Wagenburg. Zhiska armorplated his forts, pierced iron sides with loop-holes and put at each hole a soldier with a **handgun**. This may

be considered as a predecessor of present "armored vehicles" and of tanks. With the help of waggon-forts, Zhiska won many battles against the Germans until his death which took place in 1324. This insurrection is known as Hussite War and it lasted fourteen years

Accdg to Greener (Ref 7, p 49), handguns figured conspicuously during Hussite War

Note: Previous to this war the "wheeled forts" were used by the Tartars against the Russians, but they were manned by bowman instead of gunmen. The idea was resurrected in 1919 during Russian Civil War (1919-1920) when the two-wheeled carts (known under the name of *tachanka*) were equipped with light guns and machine guns

1425. In this year is the earliest known reference to *corned powder*. It was in the "Firebook" of Conrad von Schongau and listed in Marshall 1 (Ref 11, p 25). "Corning" means that the BkPdr cake was broken into small grains instead of preparing it in fine powder, known as "serpentine". The process was essentially the same as described in Vol 2 of Encycl, p B169-L

Note: Apparently, corned powder came gradually into use for small arms and hand grenades during the 15th century and for big guns in the 16th; the construction of these being sufficiently improved by that time (Ref 11, p 26)

1425. French Gunpowder mills began to grain and classify their pdr by passing thru-sieves (Ref 11, p 26)

1453. Accdg to Dutton (Ref 58, pp 49-55), the next important step in the use of firearms came during the siege of Constantinople by Ottoman Turks. In 1453 the big Army led by Sultan Mahomet II, lined up against the walls of Constantinople, fourteen batteries, totaling 69 cannons. Thirteen of the cannons were of gigantic size and could project stone balls weighing more than ½ ton each. Two of such stones measuring 46 inches in diameter may be seen now at the Turkish Museum at Istanbul. The biggest of these cannons was the *Basilica*. It required 60 oxen for dragging it on a sled. After two months of constant bombardment of all 69 cannons aimed at one section of the wall, a big gap was made and this allowed the Turkish Army to pour thru

Note: Mahomet's great cannons were cast

by a Hungarian named Urban, because such industry did not exist outside of Europe

15th Century, Middle. Accdg to Greener (Ref 7, p 27), the production of large muzzle-loading cannons became quite common in Germany and several of these huge weapons were often referred to by name, such as "Foulenette" and "Helfant". Of these, the most known was *Mons Meg* constructed in city of Mons, Belgium. It weighed nearly 4 tons and threw stones weighing over 350 lbs. It was installed at Edinburgh Castle and was supposed to have been of the same general construction as the cannon which in 1460 killed King James II. Its illustrations are on p 26 of Ref 7, together with illustration of large German cast gun. Another huge cannon was "Endorfferen" made in 1487 for Sigismund of Tyrol. It was a pair with "Bassina" at the Paris Museum (Ref 7, p 27). Illustration of French "Orgue des Bombardes" is on p 27 of Ref 7

During the reign of Henry VI, who lived betw 1421 & 1471, English artillery was inferior to that of France, and many French towns previously occupied by English fell back to French. This situation was remedied later by Henry VIII (1491-1547) (Ref 7, p 30)

Accdg to Fuller 2 (Ref 50, p 12), a light, long muzzle-loaded artillery weapon, called **Culverin** was developed in the 15th century (See Vol 3 of Encycl, p C573-L). Culverin fired iron balls weighing 17 lbs each, while its lighter model, *demiculverin*, was 9-10 pounder. Still lighter were *saker*, *minion*, *falcon* and *falconet* (See Vol 6, p F5-L)

In the book of Greener (Ref 7, pp 48-9) are given illustration of: "Early Culverin", "Hand Culverin with Bent Stock" and two "Culverins with Side Flash Pans"

1460-1480. Matchlock was developed sometime in the 15th century and Greener (Ref 7, pp 51ff) gives a brief description and illustrations taken from German MMS of 1460-80 which were located in the University Library at Erlangen. On p 52 are four figs showing the development of matchlock; on p 54 the mechanism of matchlock and on p 68, German Matchlock Gun. The guns equipped with matchlocks were known as **muskets** and the soldiers using them as "musketeers" (See Vol 4 of Encycl, p D753)
Note: Accdg to Newman (Ref 30, pp 36-7),

arquebus was replaced by musket about 1600 and at about the same time crossbowmen and longbowmen were finished, while the number of pikemen was reduced to six for every four arquebusiers or musketeers. Some pikemen were necessary to protect musketeers from heavy-armored cavalry. The **pistol** was developed so that armored cavalry could ride into the thick of the pikemen and shoot them down. The cavalry pistol was at first half size arquebus or *demi-bague* and because they were held against the chest, they were called *poitrinales*

In the book of Greener (Ref 7, pp 48-9) are given illustrations of the following early pistols: "Iron Club Pistol of 15th Century" and "Pistol Battle-Axe"

1480. Accdg to Nambo (Ref 66, p 39), compn of Swedish Gunpowder for common use was: saltpeter 57.0, sulfur 21.5 & charcoal 21.5%

1492. Accdg to Dutton (Ref 58, p 57), the success of firearms at Constantinople created big demand for them and European producers of Gunpowder and cannons became very busy. This required money to pay for them, and fortunately for Europe newly discovered America started to supply gold

1497. The first successful attempt to use anything but simple, solid, spherical projectiles (See year 1340) seems to have been made at the siege of Weissenburg. There, use was made of stone balls of slightly smaller diam than the bore of the cannon, but coated with an incendiary material and wrapped in a cloth soaked in the same material. The proj was placed thru the muzzle on top of Gunpowder and on firing the wrapping ignited and the flame did not extinguish until the target was reached. This was the first successful **incendiary projectile** (Ref 12, p 497)

15th to 20th Centuries. Hand Grenades probably existed as early as 15th century (See Vol 6 of Encycl, p G134-R, under GRENADES). Accdg to Marshall 1 (Ref 11, p 32), the early grenades, probably made of earthenware, were used at the siege of Arles in 1536. Whitehorne, writing in 1560, recommended replacing earthenware grenades by hollow balls, cast from molten mixture of brass 3 parts and tin 1 part and loading them with serpentine powder 3 parts, fine corned pdr 3 parts and rosin 1 part. A small quantity of fine corned pdr was used for priming

The term "grenades" was coined on account of their resemblance to pomegranate. By the middle of the 17th century, special military units were organized consisting of tall, strong soldiers called "Grenadiers". Grenades thrown by them consisted of hollow, cast iron balls (spheres) ca 2½ inches in diam, contg chge of BkPdr and provided with a fuse. Before throwing the grenade, the fuse was ignited. The hand grenades practically disappeared beginning with the middle of the 18th century. However, their modified versions, revived during Russo-Japanese War (1904–1905) and during WWI. As the range of grenades thrown by hand was rather short (max ca 35 yards), attempts were made to increase it by using a sling or catapult, but by throwing hand grenades by means of rifles (or using specially designed rifle grenades), ranges up to several hundred yards were achieved. More detailed information on this subject is given in Vol 6 of Encycl, pp G134-R to G139-R. Description of "Grenade Launcher" is on pp G139-R & G140-L of Vol 6

15th Century, Late. Accdg to Dutton (Ref 58, p 8), Leonardo da Vinci (1452–1519) invented a steam cannon. Such a cannon was actually built and tested during American Civil War (1861–1865) but rejected as being too cumbersome. He also invented multibarreled machine-guns, three types of them are shown on plate VI, opposite p 51 of Newnan (Ref 33)

16th Century, Early. Henry VIII improved the armament situation in England, and by 1515 there were assembled in Tower of London 400 cannons, most of them mounted on wheels. Further enlargement of supply came when Henry VIII seized in 1522 some firearms from Venetian galleys trading them to Flanders (Ref 7, p 30)

Accdg to Greener (Ref 7, pp 39–40), the war vessels of the early 16th century were furnished with small cannons which were fired from taffrail, and others which were fixed to the decks and fired thru portholes, as may be seen from illustration on p 39, showing the deck of Mary Rose (sunk by French in 1545) with big breech-loading cannons

1500 is the date of birth of Benvenuto Cellini (who died in 1571). It is given to indicate that at that time sporting firearms were already known. Cellini, when a very young man, was

very fond of shooting. The firearms were of smooth-bore (Ref 11, p 28)

1515–1547 are the years of rule of French King François (Francis) I, born in 1494. He created permanent Army and equipped it with various cannons and small arms. Illustrations on p 32 of Greener (Ref 7) include: Cannon, Great Culverin, Bastard Culverin, Culverin and two Falcons. On p 33 is shown a cannon mounted on wheels

1517. Accdg to Marshall 1 (Ref 11, p 30), the doubtful honor of having invented **infernal machine** was ascribed to a Nürenberg citizen in 1517, but there is a drawing of one by Leonardo da Vinci who lived from 1452 to 1519. In 1645 attempts were made to blow up Swedish ships in Wismar harbor by means of clock-work bombs. In them the clock-work actuated a flint lock with a revolving steel wheel. Clock-work infernal machines contg a NG explosive were used also by the Irish-American Fenians in 1882 and 1884

Note: Daniel (Ref 3, pp 268–83), under the title "Engins Criminels", described them as "devices intended for committing criminal attempts against persons or property". The following attempts against important persons are described by Daniel: 1) Dec 24, 1800 an attempt in Paris against Bonaparte, while he was First Consul resulted in death of many persons, but Bonaparte was just shaken 2) July 28, 1835 an attempt in Paris against King Louis Philippe resulted in death of many persons but left the King unhurt 3) Jan 18, 1858 an attempt by Ital patriot Count Orsini against Napoleon III left Emperor unhurt but killed and wounded many of the escort 4) March 13, 1881 an attempt against Czar Alexander II of Russia resulted in his death. Two bombs were thrown, each of thick glass loaded with Dynamite and initiated by Ag azide. The 1st bomb wounded some of the soldiers escorting the Czar. Then he ordered the carriage to stop and went to see the wounded in order to comfort them. Just before he intended to remount the carriage, the 2nd bomb hit at his feet causing most serious and painful wounds which resulted in great suffering and death. He was the best Ruler in the more than 1000-year history of Russia

Stettbacher (Ref 21, pp 417–19) described under the title "Anarchistenbomben und Höl-

lenmaschinen", construction of anarchist's bombs and infernal machines and mentioned attempts against Napoleon III and Alexander II

In his later work, Stettbacher (Ref 41, pp 130–32) described under the title "Sabotage-zünder"; chemical igniters used in anarchists' bombs and other devices

The same information is given in Spanish version of his book published in Argentina (Ref 46, pp 164–66), under the title "Bombas de Sabotaje"

1520. Rifled Small Arms are said to have been invented by Augustus Kötter of Nürenberg, but for a long time they were used for sporting purposes, because the necessity of ramming the bullet down the barrel with the spiral grooving made the loading very slow. Moreover, the powder left much fouling in the grooves, and consequently it was necessary to clean the gun after a few rounds. With the old musket which was smooth-bore, the bullet was smaller than the bore and there was no difficulty in loading, but it was not as accurate as rifles. As for sporting purposes, accuracy was more important than rapidity of fire, therefore the rifle was able to hold its own. Sporting rifles were successfully used by American colonists during the War of Independence. Then the English created the "Rifle Brigade" to fight the American marksmen (Ref 11, pp 28–9)

Note: In the Crimean War (1854–1856), rifles used by the English and French (called Stutzers by Russians) against Russian smooth-bore arms, contributed greatly to defeat of Russians

1525. Beginning with this year, bronze cannons were cast in England by Peter Bawde, French artificier. Later, in 1535, John O'Ewen was engaged in the work, and by 1543 the cannon industry was established in Uckfield, Sussex, then the center of iron industry in Britain (Ref 7, p 30)

1525. Important improvement in BkPdr was achieved in France by control of the grain size (Ref 64, p 2-2)

1533. In order to create a big Navy, Henry VIII of England needed money which he got by confiscating the properties of Roman Catholic Churches and Monasteries. This money permitted him to create a Navy, which at the time of Henry's death (1547) amounted to 53 ships, all equipped with bronze cannons. With the

aid of these ships, Spanish galleons were attacked and their gold seized. This created bad relations with Spain (Ref 58, p 61)

1543. Japanese Gunpowder "Tanegashima", early period was, accdg to Nambo (Ref 66, p 38): saltpeter 75.0, sulfur 8.3 & charcoal 16.7%

1548. Chinese Gunpowder of Ming Dynasty was accdg to Nambo (Ref 66, p 38): saltpeter 75.75, sulfur 10.6 & charcoal 13.65%

16th Century, Middle. In addition to early breech-loading cannons in which the charge of powder was loaded into a separate breech (See illustrations on pp 21–22 of Ref 7) and wedged into the cannon, there were numerous methods employed for closing the breech after inserting the charge. One of these is shown in illustration on p 37 of Greener which is not reproduced here

16th Century, Middle. Up to that time, no cartridges of any kind existed for propelling a charge of BkPdr and it was loaded loose thru the muzzle. Then the paper cartridges started to be invented and by about 1590, three types were known. They are shown in Fig 17 of Vol 4 of Encycl, p D754-R. The really successful paper cartridge was adopted by King Gustavus-Adolphus of Sweden (1594–1632) for his Army (See Fig 18 on p D755). None of the paper cartridges contained primers as we know them now (See under year 1805)

Paper cartridges were not replaced by metallic cartridges provided with caps until the beginning of the middle of the 19th century (See under year 1805)

The historical development of cartridges from paper to metallic is also described in Vol 2 of Encycl, p C73-R

1554. Accdg to Marshall 1 (Ref 11, p 23), a Gunpowder mill was erected at Rotherlithe, England

1558–1603. During this period Elizabeth I (born in 1533) ruled in England. She succeeded Mary I, during whose rule the Henry VIII Navy was neglected and many of the ships deteriorated. At that time Philip II of Spain (born in 1527 and King 1556–1598) was planning to attack England by means of newly constructed ships which formed the "Invincible Armada". Elizabeth then ordered John Hawkins to restore the Navy and Francis Drake to construct a large Gunpowder Plant at Waltham Abbey (Ref 58,

p 63). Several other mills were installed at that period and the monopoly was conferred upon Evelyn family (Ref 7, p 17). This took place, accdg to Marshall 1 (Ref 11, p 23), a few years later than 1561

1560. Compsn of two Swedish Gunpowders as listed by Nambo (Ref 66, p 39) were:

a) saltpeter 50.0, sulfur 16.7 & charcoal 33.3%

b) saltpeter 66.7, sulfur 16.7 & charcoal 16.7%

1560. Compn of English Gunpowder "Whitehorse" was, accdg to Marshall 1 (Ref 11, p 20): saltpeter 50.0, sulfur 16.6 & charcoal 33.3%

1569. Compsn of two Japanese Gunpowders

are given by Nambo (Ref 66, p 38): a) salt-

peter 77.6, sulfur 10.7 & charcoal 11.7%

b) saltpeter 76, sulfur 12 & charcoal 12%

1578. Accdg to Marshall 1 (Ref 11, p 27), the first instrument for testing Gunpowder was devised by Bourne. Up to that time, the only test was to burn a small quantity to see how much residue would be left. The instrument of Bourne consisted of a small metal cylinder with a heavy metal lid on a hinge. The lid was prevented from falling by a ratchet, and the angle to which it rose when powder was fired inside the cylinder measured the strength. A much better instrument was invented in 1627 (qv)

1587. English Navy, under Admiral Drake, attacked and destroyed the Spanish galleons assembled in Cadiz in preparation for the attack against England (Ref 58, pp 66-7)

1588. After repairing ships damaged at Cadiz and rounding up more of them, Philip II sent, early in 1588, 132 ships forming the "Invincible Armada" against English 40 warships and 150 merchant ships equipped with guns, under Lord High Admiral Lord Howard of Effingham. The Armada came late in July to Plymouth, where it was attacked by the English, who destroyed many ships by burning them. The remaining ships escaped across the channel to Calais, but they were pursued and attacked again. Finally, the Spanish Admiral decided to escape to Spain thru North Sea. This happened to be very rough and it contributed to destruction of many ships. By the time Armada arrived at Spain, there were less than 50% of ships, while English lost no ships (Ref 58, pp 67-8)

1588. Accdg to Colver (Ref 12, p 497), early hollow shells were used by Chinese. They were made of earthenware. They were filled

with incendiary mixts and provided with a fuse which was supposed to ignite on firing of proplnts. These shells were dangerous to use because they often broke inside the bore. The first successful hollow shells and shrapnel are briefly described in next item

1588. Accdg to Marshall 1 (Ref 11, p 31), the first really successful explosive shell was employed at the sieges of Wachtendonck and Bergen-op-Zoom, Holland. This was due to the employment of newly invented igniter (fuse) by an Italian master gunner refugee from Parma. The fuse apparently consisted of a tube (or pipe), filled with slow-burning powder, which was driven into fuse-hole of the shell. This type of fuse was made to burn 14 to 20 seconds, corresponding to ranges 1000 to 2000 yards in the mortars, which were always used instead of cannons for throwing shells. Such shells were used for the destruction of stone fortifications and ships; against men they were not very effective, as there was usually time to get away from them or to extinguish the flame of fuse by water or sand. Until after the introduction of watches, which were invented in 1674 by Christian Huygens of Holland (1629-1695), no convenient means existed for testing the time of burning of a fuse. In the middle of the 18th century fuses were made of beechwood with a hole down the middle filled with fuse powder. They were of different lengths. Great accuracy was not required of them until Capt Mercier, during the siege of Gibraltar in 1779, proposed to fire shells from cannons instead of mortars or howitzers. Accurate fuses were also required for the Shrapnel, invented by Lt Strapnel ca 1784 and officially adopted by British Govt in 1803. These fuses were replaced after 1831 by Bickford fuse, described in Vol 2 of Encycl, p B112-L (Ref 11, pp 32 & 38)

1595. Accdg to Marshall 1 (Ref 11, p 31) and Nambo (Ref 66, p 39), compn of German Gunpowder was: saltpeter 52.2, sulfur 21.7 & charcoal 26.1%

1597. Chinese Gunpowder of Ming Dynasty contd: saltpeter 80.66, sulfur 5.64 & charcoal 13.70% (Ref 66, p 38)

16th Century, End. Accdg to Chalon (Ref 8, p 228), quoted by Marshall 1 (Ref 11, p 27), the French compn of "Poudre noire" of proportion 6:1:1 (meaning saltpeter 75.0, sulfur

12.5 & charcoal 12.5%) has been adhered to there more or less ever since. It is also listed by Nambo (Ref 66, p 39) as of year 1598
Note: It is mentioned by Marshall 1 (Ref 11, p 27), that German powder contg saltpeter 66.6, sulfur 16.6 & charcoal 16.6% was more satisfactory than French powder and that the German Cocoa Powder was ballistically the best BkPdr ever made

1606. Accdg to Nambo (Ref 66, p 28), the Chinese Gunpowder for general purpose, described by Wu Pei Chih of Ming Dynasty contd: saltpeter 75.0, sulfur 12.5 & charcoal 12.5%

1608. Accdg to Marshall 1 (Ref 11, p 27), Danish BkPdr contd: saltpeter 68.3, sulfur 23.2 & charcoal 8.5%

1611–1632. During the rule of Swedish King Gustavus Adolphus (born in 1594) many improvements in military weaponry were introduced. He is considered by Dupuy & Dupuy (Ref 69, pp 522–24) as the father of modern field artillery and of the concept of massed, mobile artillery fire. His 3-pounder regimental cannon, illustrated on p 524, looks like a modern weapon. He was also the inventor of an improved paper cartridge which is illustrated in Vol 4 of Encycl, p D755. This invention permitted an increase in the rate of fire. For further development of cartridges, see year **1826**

Gustavus Adolphus was the initiator and successful participant of "The Thirty Years' War" (1618–1648), which started as a religious war between Protestants and Catholics. The War, which involved several nations, is described in Ref 69, pp 533–46. The King personally was engaged in many battles and was killed in 1632 at the battle of Lützen. Then Bernard took command and the war continued until 1648. As result of peace treaty of Osnabrück, Sweden received an indemnity, and substantial Baltic coastal territories belonging to Russia, and to Catholic part of Germany

1615. Accdg to Dupuy & Dupuy (Ref 69, p 523), the true *fusil* or *flintlock musket* was invented by French gunsmith LeBourgeois. It was perfected as a *sporting* weapon about 1630, but was not adopted for military purposes until 1670 in France and then later in other European Armies. By ca 1680, someone – possibly S. Vauban (1633–1707) – invented the ring bayonet, which left the bore clear for firing

1621. Accdg to Nambo (Ref 66, p 38), the Chinese Gunpowder for propulsion described by Wu Pei Chih of Ming Dynasty, contained: saltpeter 77.0, sulfur 9.5 & charcoal 13.5%

1627. According to Marshall 1 (Ref 11, p 27), a much better instrument for testing BkPdr than that of **1578** (qv) was devised by Curtenbach. This consisted of a heavy conical shot which rested on the mouth of small mortar and could travel vertically upwards along a stretched wire provided with series of catches to stop the shot from falling down

1627 and Later. Black Powder in Mining. Accdg to Dutton (Ref 58, p 90), a Hungarian engineer, Kaspar Weindl, experimented in blasting ore near the town of Selmezbanya by means of BkPdr. From that time, use of BkPdr for breaking ores spread to Germany, Sweden and other countries. Accdg to Marshall 1 (Ref 11, p 33), blasting was probably introduced to England in 1670, and in 1689 Th. Epsly Sr started to use BkPdr in Cornish mines

Accdg to O. Guttmann, as quoted from Marshall 1 (Ref 11, pp 33–4): "When bore-holes first came into use they were made with iron-mouthed borers, fairly large – nearly 3 inches in diameter, and then closed with a wooden plug termed the shooting plug. Henning Hutmann in **1683** employed a kind of drilling-machine. In **1685** clay tamping and in **1686** firing-tubes began to be used. In **1689** paper cartridge cases were used to replace the older form of leather, and in **1717** bore-holes of smaller diameter came into vogue. The use of the chiselborer dates from **1740**, blasting the untouched breast from **1767** (first at Zinnwald)"

1635. Accdg to Marshall 1 (Ref 11, p 26) and Nambo (Ref 66, p 39), English Gunpowder of Government Contract contd: saltpeter 75.0, sulfur 12.5 & charcoal 12.5%

1637. Accdg to Nambo (Ref 66, p 38), the Chinese BkPdr for bursting charges, described by Tien Hung of Ming Dynasty contd: saltpeter 82, sulfur 9 & charcoal 9%

1643–1715. During the rule of Louis XIV, the Great of France, an Army of nearly 400 thousand men, serving as volunteers, was organized and its frontiers were fortified by famous military engineer Vauban (1633–1707): Louis XIV equipped his infantry with *flint*

muskets, which replaced *arquebus* and *matchlock*. His muskets were equipped with *bayonets* and *paper cartridges*, which by 1700 allowed the firing of two rounds per minute instead of previously one round. Some infantrymen were put on horses and the resulting cavalry became known as *dragoons*. At Essonne, near Paris, a Gunpowder plant was constructed which manufd an improved product in seven sizes from finely ground grains for handguns to walnut size pellets for the large cannons. The use of large-grain pdr increased the range 1 or 2 miles. Towards the end of his rule, corruption, abuse & inaccurate payment developed and the number of available volunteers stopped. These corruptions and huge debts were passed in 1715 to Louis XV (1710–1774) and finally to Louis XVI (born 1754, deposed in 1792 due to revolution and guillotined in 1793). The first universal conscription was introduced in August 1793 (Ref 58, pp 72–88)

1646. Bofors Industries (Aktiebolaget Bofors) of Sweden was established to become one of the world's largest companies manufg expls, proplnts, ammo and weapons. A brief description of its activities is given in Vol 2 of Encycl, pp B218 to B220

1647. Accdg to Nambo (Ref 66, p 39), the compn of Swedish Gunpowder of Nye was: saltpeter 66.6, sulfur 16.7 & charcoal 16.7%

1647. Master-Gunner Nye, in his "Art of Gunnery", described the instrument of **1627** (qv), and also proposed that the strength of powder be measured by firing bullets from a pistol into clay, or by firing a ball from a mortar and finding out how far it travelled.

This mortar test was adopted by French as "mortier éprouvette" and was also used by other countries (Ref 11, p 28). Further improvement in testing was done in 1742 (qv)

17th Century, Middle. Accdg to Marshall 1 (Ref 11, p 34), it seems that K chlorate was known to Glauber (1603–1668), but it was not investigated until about **1786** (qv), when Count C.L. Berthollet lived (See Vol 2 of Encycl, p B106-R)

1654. Ammonium Nitrate (AN) was first prepd by J.R. Glauber (1603–1668) who also prepd Na sulfate. It was not until beginning of the 19th century that it started to be used as a replacement for K nitrate in BkPdr. In 1840

Reise & Millon reported that a mixt of powdered AN and charcoal exploded on being heated to 170°. In 1867 Ohlsson & Norrbin patented its use in mining expls, and in 1870 A. Nobel purchased their patent (Vol 1 of Encycl, p A342-L). Nobel then introduced a series of AN expls, called **Extra Dynamites** and **Ammonium Nitrate Gelatins**. During WWI, AN found extensive application in its mixt with TNT (such as **Amatol** and **Ammonal**) or with other HE's such as Di- and Tri-nitronaphthalene (Vol 1 of Encycl, p A341 and Tables on pp A355 & A356 (See also Vol 5, under **DYNAMITE**, p D1583 and as "**Do-It-Yourself**" **Ammonium Nitrate–Fuel Oil Explosives** in Vol 5, pp D1528 & D1529

The latest development in AN-contg expls is its mixtures with fuel oils. Such expls are known as **AN-FO** and their brief description is given in Vol 6 of Encycl, pp F211-R to F213, under Fuel Oils

1666. Chain Shot was invented by DeWitt of Holland, for use against the rigging of ships. It consisted of two balls or half balls united by a chain (Ref 11, p 31) (See under **Grape Shot** in Vol 6 of Encycl, p G126-L & R

1669. Accdg to Dutton (Ref 58, p 114), phosphorus was discovered by a German chemist named Brand, who prepd it from urine

1689. Accdg to Feldhaus, SS 2, 218 (1908), as quoted in Marshall 1 (Ref 11, p 22), Thomas Epsly Sr started the use of Gunpowder in Cornish mines, England

1689–1725. Accdg to Dupuy & Dupuy (Ref 69, p 645), the Czar Peter I (The Great, born in 1672) completely reorganized Russian Army and Navy, equipping them with latest arms. This permitted him to win the "Great Northern War" (1700–1721) against Sweden, lead by the greatest warrior of that time, King Charles XII, born in 1682, ruling during 1697–1718 (Ref 69, pp 614–617). By the treaty of Nystadt (1721), Russia recaptured the Baltic provinces ceded to Sweden during "The Thirty Years' War" (1618–1648), lead until his death in 1632 by the great Swedish King Gustavus Adolphus (born 1594, ruling 1611–1632) (Ref 69, pp 533–46)

1696. The Swiss used drills of tempered iron for drilling boreholes in rocks during blasting with BkPdr thru Alps in constructing the Albula Road, the main thoroughfare for wagon travel (Ref 58, p 93)

18th Century, Beginning. Accdg to Marshall 1 (Ref 11, p 36), **flintlock** was invented, but accdg to other sources it was in the middle of 17th century. Its other name was **firelock** and it replaced the **wheel-lock**. A brief description is given in Vol 4 of Encycl, pp D754--55).

The improved types of flintlocks were used by the British as late as 1850 and by the Americans as late as the end of Civil War (1865)

18th Century. Cannons, which since the 16th century were cast in bronze, started to be cast in iron. Until the 2nd half of the 19th century, a cannon consisted simply of a block of cast metal with a smooth-bore machined out and a vent drilled near the breech. It is true that the breech-loading guns were made at a much earlier date (See illustrations on pp 21, 22 & 37 of Greener's book of 1910), but they were not adopted because the breech leaked (Ref 11, p 29)

1707. Chronographs. The earliest device was conceived by Cassini, but the first practical instrument based on his idea was constructed in England in 1740 by Robins. This instrument underwent in later years many improvements, such as by Hutton (1775), Didion-Morin-Piombert (1836), Piombert (1860) and Minarelli-Fitzgerald (1900-01). Other older devices are listed in Vol 3 of Encycl, p C305, while more recent devices, such as of LeBoulangé, Aberdeen, Mettegang, Pin Chronograph, etc are described on pp C306 to C318

1738. Closed Bomb or Vessel. The first recorded attempt to measure the pressure generated when Gunpowder was fired in a closed space (such as bomb or a gun barrel) was made in 1738 by d'Antony in Italy. This was followed in 1742 by Robins in England, d'Arcy in France (1760) and by Count Rumford in Germany (1792). More accurate measurements could be obtd in the 19th century, such as using instruments invented ca 1860 independently by Maj T.J. Rodman in US and by Gen N. Mayevskii in Russia. Other devices were of Sir A. Noble & Sir F. Abel of England and of M. Deprez, E. Sarrau & P. Vieille of France. Bichel Bomb was invented in 1898 in Germany. In Russia the Dolgov Bomb has been used. It consists of a vertical cylinder. All of these bombs are described in Vol 3 of Encycl, pp C330 to C345

1742. Accdg to Marshall 1 (Ref 11, p 28), Robins placed the mortar described by Nye in 1647 (qv) on a more scientific basis by the invention of the **ballistic pendulum** by means of which the actual velocity of a projectile could be measured

1745. Electric Cap was invented by Dr Watson of England and improved in 1749 by B. Franklin of US, but the device was forgotten until 1830 when Moses Shaw was granted a patent for a similar device. It was a "high tension" cap. The first "low tension" cap was developed by M. Shaw with the assistance of Dr R. Hare (Vol 1 of Encycl, p B186-R)

The biggest contribution to the construction of modern cap was done by L.A. Burrows of duPont Co beginning about 1937 (Vol 1 of Encycl, p B187 & p B363-L, giving a list of his inventions)

1765. Accdg to Dupuy & Dupuy (Ref 69, p 665), J.B. deGribeauval (1715-1789) began to revolutionize French Artillery, and his 4-, 8- & 12-pound guns and 6-inch howitzers were later used by Napoleon

1766. Henry Cavendish (1731-1810), the British physicist and chemist, was the first to identify hydrogen (Ref 58, p 113)

1771. Picric Acid (PA) was first prepd by Woulfe on treating silk with nitric acid. It was used as a yellow dye, and its expl props were not discovered until 1871 (See also 1843) (Ref 11, p 49 & Ref 12, p 6)

1772. Daniel Rutherford (1749-1819), Scotch botanist, first identified nitrogen (Ref 58, p 113). Do not confuse with Lord Ernest Rutherford (1871-1937), Brit physicist noted for his research on radioactive transformation and disintegration of nitrogen

1774. Swedish alchemist K.W. Scheele (1742-1786) separated from saltpeter its "fire-air", now known as oxygen. He also obtd glycerin and identified chlorine and fluorine (Ref 58, p 112)

1780. Potassium Chlorate was discovered by C.L. Bertollet, and he prepd some expl mixts contg it (See Vol 2 of Encycl, p B107-L). Two disastrous explns in 1788 & 1792 during pulverizing and mixing the expls contg it stopped its use for a while (See Vol 2 of Encycl, pp C190 to C197 & C202, and also under 1850. **Chlorate Explosives**

1782. Ballons & Airships and Their Application in War. Under this title there is described in Vol 2 of Encycl, pp B10–B11 their historical development. The first successful balloon was invented in 1782 by brothers Mongolfier of France, and ever since then attempts have been made to use them for military purposes, such as for observation and later for dropping bombs (See under year **1849, Bombs, Aerial**)

The most ingenious application of balloons guided only by prevailing winds was made by the Japanese against US territory in 1944. It is briefly described in Vol 2, p B11-L and more fully by R.W. McKay in Engineering Journal **28**, 263–67 (1945), under the title “Japanese Paper Balloons”

1784. Accdg to Guitmann, as quoted from Marshall **1** (Ref 11, p 26), presses were introduced to compress the mill-cake BkPdr before corning. It was in order to obtain really compact grains of BkPdr

1784–1785. Shrapnel shell was invented by Brit Lt Shrapnel to use against troops in the open (Ref 11, p 31). It partly replaced case-shot, described in Vol 2 of Encycl, pp C24-R & C25-L. A brief description of Shrapnel shell is given in Colver (Ref 12, p 497). It was adopted in 1803 by British Govt for military purposes

1786. Potassium Chlorate, supposed to be discovered by Glauber in the 17th century (middle) was prepd by C.L. Berthollet in pure state and its props detd. He proposed using it in lieu of K nitrate in BkPdr, but abandoned the idea after disastrous expln during its manuf in 1788, which killed several persons. The first successful mixts using K chlorate were Cheddites (See Vol 2 of Encycl, p C155ff and Marshall **1** (Ref 11, pp 35–36)

1789. Accdg to Marshall **1** (Ref 11, p 26), at Faversham, England the powder was compressed by means of a screw-press, while the hydraulic presses were introduced in the 19th century.

1789. Uranium was obtd by German chemist M.H. Klaproth (1743–1817), who also obtd titanium and zirconium. Uranium was obtd by roasting radioactive pitchblend (Ref 58, p 114)

1792. Accdg to Marshall **1** (Ref 11, p 33), the Indians fired rockets in the defense of Seringapatom, but they did not appear to have done much damage, while at the siege of the same

town in 1799, explosive rockets were used with some success

18th Century, End. Accdg to Marshall **1** (Ref 11, p 28), practically every country had come to use Gunpowder of compn: saltpeter 75.0, sulfur 10.0 & charcoal 15%

19th Century, Beginning. Accdg to Colver (Ref 12, p 498), considerable use was made of red-hot iron shot particularly in combat with wooden ships

19th Century, Beginning. Ammines or Ammoniates were invented, but they were not systemized and explained until 1893 when Alfred Werner introduced his theory of *coordinated compounds*. Many of them are explosive, as can be seen from Tables in Vol 1 of Encycl, pp A277 to A282

1800. Accdg to Marshall **1** (Ref 11, p37), Mercury Fulminate was invented by Edward Howard, who described it in a paper before the Royal Society

1802. Eleuthère Irénée du Pont de Nemours, French immigrant, began the manuf of BkPdr at a mill situated on the banks of Brandywine Creek, near Wilmington, Delaware. The compn was approx: saltpeter 75, sulfur 10 & charcoal 15%. The manuf was continued until 1921 (Ref 52, p 3)

1805. Accdg to Marshall **1** (Ref 11, pp 36–37), the Rev A.J. Forsyth, a Scotch clergyman, made a sporting gun with *detonator lock*. He patented the device (which is described in Vol 4 of Encycl, p D755). As the device was initiated by the blow of a hammer, it was the original **percussion lock**. The device was not adopted by the British Ordnance because it was not considered suitable for military purposes. Before many years elapsed, Forsyth's device was displaced by a copper tube or cap contg Mercuric Fulminate. It is not certain who invented the MF cap. Accdg to H. Wilkinson, J. Shaw of Philadelphia invented a steel cap in **1814**, a pewter (alloy of tin with some lead) cap in **1815**, and copper cap in **1816**. J. Egg of London seems to have adopted the idea from Shaw. Prêlat and Deboubert of Paris patented in **1820** caps filled with MF and AgF, respectively. E.G. Wright of Hereford published in 1823 a paper on the MF cap, contg much information. Frederick Joyce was the first to make a real success of percussion cap ca **1824**

The next important step was to combine shot, powder and cap in one cartridge, which could be inserted in the breech of the arm. In **1836** LefaucheuX introduced his *pin-fire* breech-loading shotgun, the barrels of which were made to drop as in the modern weapon to allow the cartridges to be introduced. About 1853 the English and French gun-makers introduced the *center-fire* hammer gun, which fired cartridges having a cap in the middle of the base of the cartridges, but the first really successful center-fire gun was that made by Daw in **1861** (Ref 11, p 37)

More detailed description of capped cartridges is given in Vol 4 of Encycl, p D756-L

1807 to 1815. Accdg to Marshall 1 (Ref 11, p 33), Col Congreve of the Hanoverian Army (later Sir W. Congreve), independently from Indians (See 1792AD) developed, sometime before 1807, a rocket, the most powerful device of its kind that had been used in warfare. It proved very effective at Copenhagen and Walcheren in 1807 and at the passage of the Adour in 1813, but it was at the battle of Leipzig in 1813 that it achieved its greatest renown. It also rendered good service at Waterloo in 1815 and during the War of 1812 between the US and Gt Britain

Since the Napoleonic Wars, the improvements in ordnance have been so great that the rocket ceased to be used as a weapon. However, it continued to be used for signalling and illuminating purposes, until it was displaced to a great extent by star shell

1819. Accdg to Marshall 1 (Ref 11, p 26), Col Congreve introduced his granulating machine for BkPdr which is described on p 82. It has been used in England for many years
1823. Accdg to Colver (Ref 12, p 4), MF (Mercuric Fulminate) was proposed by Wright as an igniter of Gunpowder

1825. Accdg to Dutton (Ref 58, pp 156-57), the Rev Dr Clayton began in England investigation of products on distillation of *coal tar*, which was obt'd from bituminous coal. He isolated benzene, creosote, naphthalene and other chemicals. Most of his products were later nitrated, giving expl's. The investigation was continued by A.W. vonHofmann (1818-1892), who came to England from Germany and by W.H. Perkin (1838-1907). Many dyes

were produced, such as mauve and alizarin. Aniline was also prep'd and this gave on nitration the very powerful **Tetranitroaniline** which is described in Vol 1 of Encycl, pp A425ff. Other important expl's obt'd on nitration of products of distillation of coal tar were **Di-** and **Trinitrobenzene** (Vol 2 of Encycl, pp B46ff) and **Nitronaphthalenes**, which will be described under Naphthalene and Derivatives

Dr vonHofmann moved back to Germany in 1874 where he established a large scale coal tar industry

1826. Cartridges for Ammunition. It was mentioned under **1350. Bullets** and under **1611-1632** that the first successful paper cartridge was invented during the rule of King Gustavus Adolphus of Sweden (1611-1632). This type of cartridge was not, however, self-sustained because it was not provided with a primer which was not known at that time. The first self-contained paper cartridge was invented in 1826 and improved on in 1831. The first metallic cartridge was invented in 1846 by Houiller of Paris. It is known now as "pin-fire cartridge". He also invented the "rim-fire cartridge". The first successful "center-fire cartridge" was invented in 1858 by Morse and improved by Col Berdan. It was adopted in 1865 by the US Army. Previously to this (1854) Smith & Wesson developed a successful metallic cartridge for revolvers. Further development of cartridges and their construction are described in Vol 2 of Encycl, pp C73 to C76

1826. Aniline was first prep'd by Unverdorben (Vol 1 of Encycl, p A406-L)

1831. Safety Fuse invented by W. Bickford (See Vol 2 of Encycl, p B112-L) and in 1840 the Bickford fuse was adopted by the English military authorities. In 1836 a factory was started in US, in 1839 in France, and in 1844 in Germany. Before 1840 guttapercha-covered fuse had been adopted for blasting under water. Various modifications have since been invented, including fuse cased in metal "Colliery Fuse" (patented in 1886 by Sir G. Smith), which emits no sparks; and various sorts of "instantaneous fuses", which burn very rapidly and enable many shots to be fired simultaneously (Ref 11, p 38)

1832. Ammonium Perchlorate was first prep'd by Mitscherlich (Ref 70, pp 26 to 28)

1832-1833. French chemist H. Braconnot of

Nancy found that on treating starch (in cold) or wood (in hot) with concd nitric acid there was obtd a viscous liquid, which on addn of water deposited a white powder which, on drying, dissolved in ether-alcohol mixture and easily burned when ignited. It was named *xyloidine* but is actually *Nitrostarch* (Ref 44, p 240 & Vol 2 of Encycl, p C101-L) (See also Ref 31a, p 245)

1833. *Nitrostarch (NS)* was first prepd by Braconnot, who called it *xyloidine*. Pelouze prepd it, in 1838, in purer condition and studied its props. It was used in the US during WWI and WWII as demolition expl and for bursting charges (Ref 70, pp 246 to 248)

1834. The earliest attempt to nitrate aromatic nitrocompounds was by E. Mitscherlich (1794–1863), in Germany, who nitrated benzene to *m*-DNBz and toluene to MNT's (Ref 12, p 18)

1837. Accdgd to Dutton (Ref 58, p 125), Emanuel Nobel, father of Alfred Nobel, invented, at 35 years of age, a torpedo. It exploded and wrecked his home. He was ordered to leave Stockholm. So he went to Russia to operate a torpedo factory near St Petersburg. He settled in Russia and his sons, including Alfred, were educated there. When Crimean War broke (1853) his torpedoes (or rather mines) loaded with NG-NC prevented the British fleet from approaching Cronstadt, which was the fortress guarding St Petersburg. After the war, Emanuel, with Alfred and Oscar, returned to Sweden, while Robert & Ludwig remained in Russia to work in Baku oil fields. They became millionaires

1837–1838. Prof T.J. Pelouze of Paris (1807–1867) nitrated (other than starch) cellulosic substances, such as paper, and called the resulting product *xyloidine*, which was sol in eth-alc. He also treated cotton fibers with concd nitric acid, without allowing them to be destroyed. He plunged the nitrated fibers in large amt of cold water, followed by several washings and then drying. The product was highly combustible but insol in eth-alc. This was not *xyloidine* but a higher nitrated product as was proved by Pelouze in **1846**. He named it *pyroxyline* or *pyroxyle* (Ref 31a, pp 245–46; Ref 44, p 240 & Vol 2 of Encycl, p C101)

1840. Accdgd to Marshall 1 (Ref 11, pp 37–38), the Prussians adopted a breech-loading rifle, the *Zündnagelgewehr*, invented in 1838 by Dreyse.

In this ignition was effected by a needle being driven right thru the base of the cartridge into a disk of fulminating material. In spite of some defects, such as escape of gas and rusting of needle, the gain in rapidity of fire caused it to be maintained in general use during the wars of 1848, 1866 and 1870. The French adopted Chassepôt in 1866, which was a considerable improvement upon the Prussian rifle. At about the same time, the English rifle of Mr J. Snider, an American, was invented. This rifle was considerably improved by Col Boxer by adopting a brass case instead of paper as in previous rifles (Ref 11, p 38)

1841. *Ammonium Picrate* was first prepd by Marchand and used in 1869 by Brugère as propellant (Ref 70, p 138) (See also **1909**)

1843. *Picric Acid (PA)*, discovered in 1771 by Peter Woulfe (inventor of 2- or 3-necked bottle) but not identified, was rediscovered by A. Laurent (1807–1853). He prepd it by nitrating phenol or Dinitrophenol with nitric acid and identifying it as Trinitrophenol. He did not recognize it as an expl, but found that some of its salts are expl. When the price of phenol became reasonable, PA started to be used as a fuel in expl mixts, while its salts were used as expl additives (See also under 1871 and 1885) (Ref 11, p 49)

1844. Prof C.F. Schönbein of Univ of Basel (1799–1866), discovered ozone (Ref 11, p 39)

1845. Schönbein on treating cotton with mixed nitric-sulfuric acid during a short time (in order not to destroy fibrous structure) obtd, after washing with large amt of w and drying, a very combustible product which was named "coton-poudre". The product was tried in mining (Ref 31a, pp 241–48; Ref 44, p 240 and Vol 2 of Encycl, p C101-L, under CELLULOSE NITRATE)

Note 1: Dutton (Ref 58, pp 119–20) said that Schönbein discovered NC by accident. He wiped nitric-sulfuric acid spilled in the kitchen with his wife's cotton apron. Then he rinsed the apron with water, hung it to dry over a hot stove and then he heard a loud expln. He repeated the nitration using another apron, which he rinsed and dried more carefully than the first one. Then he cut from the apron a strip and lighted it with a match. The strip rapidly burned without leaving any ash

Note 2: Accdg to Davis (Ref 31a, p 247), Schönbein also described the nitration of *cane sugar*, which was performed in December 1845, but he deliberately refrained from telling how he prepd NC. His *Nitrosugar*, prepd as described by Davis (Ref 31a, pp 247–48), was dried at low temp. At 100° it was semi-liquid and at higher temps gave off red fumes. When heated more strongly, it deflagrated suddenly and with violence

1846. Otto of Brunswick described in *Allgemeine Zeitung* of Oct 5, 1846 procedure for making NC very similar to *coton-poudre* of Schönbein (Ref 44, p 240)

1846. W. Knopp of Leipzig, Heerben & Karmarsch of Hanover and J. Taylor of England described prepn of *coton-poudre* by nitrating cellulose with mixed nitric-sulfuric acids (Ref 31a, p 250 & Ref 44, p 240)

1846. Italian chemist, A. Sobrero, obt'd on treating glycerin with mixed nitric-sulfuric a very expl liquid which he called *glycérine fulminante* or *pyroglycérine* (Ref 44, p 241)

1846. Sauerbrey of Switzerland started to manuf rifles using *fulmicoton* and exported them to various countries, chiefly to Austria, but this stopped in 1848–1850 (Ref 44, p 241)

1846. Schönbein proposed using *coton-poudre* as more powerful replacement of *poudre-noire* (BKpDr) (Ref 44, p 241)

1846. Dr Bley of Bernberg prepn NC by nitrating sawdust and suggested its use in lieu of BKpDr (Ref 31a, p 251)

1846. John Hall & Sons of Faversham, England started to manuf *coton-poudre* by the method of Schönbein, but this was abandoned after a terrible expln on July 14, 1847 which destroyed the plant (Ref 44, p 241)

1846–1847. R. Böttger of Frankfurt on Main (1806–1887) prepd “*coton-poudre*” independently of Schönbein. They joined in obtaining a patent, including one for US, under the title: “Improvement in Preparation of Cottonpowder and Other Substances as Substitutes for Gunpowder” (Ref 31a, p 249; Ref 44, p 240 & Vol 2, p C101-L)

1846–1850. Accdg to Colver (Ref 12, p 498), the first real advances in fusing of shells were made at that time. Early shell fuses have been made with the intention of their being ignited by the flame of the propnt chge. Then Freeborn designed, by an adaptation of the per-

cussion cap, a time-fuse (or rather *time-fuze*) which was initiated by the shock of discharge of the projectile from the gun. On the latter date Moorsom introduced the first shell fitted with a fuze actuated by the shock of impact of the shell

1847. Mannitol Hexanitrate or Hexanitromannitol was first prepd in Italy by A. Sobrero. N. Sokoloff of Russia examined in 1878 its expl props. Used as secondary chge in detonators and blasting caps (Ref 70, pp 197 to 200)

1847. A big expln killing 21 men took place at Faversham (England) factory manufg Guncotton by the Schönbein method. After this Hall & Sons, who were the contractors, refused to proceed with the manuf. About the same time there were disastrous Guncotton explns at Vincennes and Bouchet, and these produced such an effect that no more Guncotton was manufd in England & France for the next 16 years (Ref 11, p 39)

1847. In France, the “Commission du Pyroxyle” was formed, charged with investigating the possibility of replacing BKpDr with NC (plus some dextrin) as rifle propnt, but the idea was abandoned after violent explns at Vincennes and Bouchet (Ref 44, p 241)

1847. Gladstone of England, by exercising special precautions, was able to determine nitrogen content of pyroxyline as 12.75%; which corresponds to pentanitrate, while the xyloidine corresponded more nearly to trinitrate (Ref 44, p 252)

1847. Crum of England nitrated cotton (previously bleached by special process) until he could introduce no further nitrogen into the molecule. After washing and drying the product it was analyzed by nitrometer method which gave 13.69% N. Nitration was done by mixed nitric-sulfuric acid as described in Davis (Ref 31a, p 252)

1847. Cyanuric Triazide, first prepd by Cahors, and in 1887 the process was improved by James Taylor & Rinkenbach prepd it in 1923 & 1927 in pure state and detd its expl props (Ref 70, pp 66–68). See also Vol 3 of *Encycl*, pp C590-R & C591-L

1849. Bomb, Aerial. After the invention of balloon (aerospace) by Brothers Mongolfier in 1782, several attempts were made to use balloons for throwing bombs from the air. One of the

first such attempts was made during the siege of Venice by Austrians in 1849. A brief description of this operation is given in Vol 1 of Encycl, p B225-R. Not much was done after this in the 19th century because in 1899 aerial bombing was forbidden by the Hague Convention. In 1903, the Wright Brothers constructed a successful aeroplane, and in 1907 the restriction on aerial bombardment was lifted. By 1910 nearly all nations started experimenting with planes dropping such bombs. The earliest recorded use of bombs dropped from a plane was by the Italians ca 1911 during the war in Tripoli. More successful was the use of improved bombs by the Spanish during the war in Morocco. During the first 3 months of WWI no bombs were dropped because the planes and dirigibles were not equipped for this purpose, but on Aug 30, 1914 a single German plane dropped bombs on Paris and one of the bombs penetrated into a crowded subway station, killing and mortally wounding 1000 persons. Then Germans also used Zeppelins in night raids on London. Considerable aerial bombing was done during the Spanish Civil War (1936-1939), but the greatest use was during WWII. For further development of aerial bombing, see Vol 2 of Encycl, pp B226-B232. German bombs of WWII are described and illustrated in PATR 2510 (1958), pp Ger 14 to Ger 20 (See also under the year 1782)

1850. Chlorate Explosives. After disastrous explns of 1783 & 1792 with mixts using K chlorate (discovered in 1780 by C.L. Berthollet), there were no applications of chlorate until about 1850. One of the earliest chlorate expls was **Augendre Powder** listed in Vol 1 of Encycl, p A507-L. The mixt was, however, too sensitive for use. The problem of desensitization was solved in 1871 by H. Sprengel. Still better expls were developed in 1881 & 1888 by E. Turpin and in 1897 by Street. A fairly complete list of chlorate explosives is given in Vol 2 of Encycl, pp C202 to C209

1850. Accdg to Nambo (Ref 66, p 39), the French Gunpowder of the Napoleon III Army contd: saltpeter 75.6, sulfur 10.8 & charcoal 13.6%

1850. Cameras, High-Speed Photographic. The first attempt to photograph a rapid event was made by H.F. Talbot of England, and his tech-

nique was applied in 1884-85 by E. Mach & P. Salcher to ballistic studies. In 1909 C. Cranz designed an apparatus called "Ballistische Kinematograph" capable of taking 50000 frames per second and an improved app capable of taking 100000 fps was designed in 1912 by C. Cranz & B. Glarzel. A description of Cameras is given in Vol 2 of Encycl, pp C13 to C19 and in this Vol under High Speed Photography, pp H104ff

1850. Electric Friction Machine suitable for field use was invented by Baron von Ebner of Austria. After being improved in 1869, it was used in the blasting of Hoosac tunnel (Vol 2 of Encycl, pp B187-L & B212-L)

1852. The Committee appointed by Confédération Germanique, to which Schönbein & Böttger proposed in 1846 the cessation of their method, refused the proposition (Ref 44, p 241)

1853. Baron von Lenk, representing Austria, was happy that Prussia did not obtain the patent of Schönbein & Böttger dealt directly with them to obtn the method. He started to work on improvement of stability and possibility of adopting the improved powder as cannon propellant (Ref 44, p 242)

1853. Emmanuel Nobel (1801-1872), father of Alfred Nobel, installed sea mines of his invention in Baltic Sea to protect Russian fortress Cronstadt and City of StPetersbourg against British Fleet during the expected Crimean War (See Vol 5 of Encycl, p D1585-L)

1853-1856. During Crimean War, K.I. Konstantinov constructed in Russia several pyrotechnic rockets (Ref 71, p 16)

1853-1865. Beginning with one artillery battery using NC as proplnt, the number increased to thirty, although the powder caused erosion of the bore and occasional cracks in the walls of projectiles. While these problems preoccupied the artillerists, a terrible expln took place in 1863 at Simmering, near Hitenberg (of the Gunpowder factory erected in 1853). A 2nd expln took place in 1865 at Simmering near Vienna, and this provoked the Imperial Edict of 11 Oct, 1865 prohibiting manuf of NC in Austria. This expln broke the negotiations with France and US, to whom von Lenk proposed his method (Ref 31a, p 253 & Ref 44, pp 241-42)

1854. Introduction of the earliest Dynamite

called *Magnesia'nyi* by Russian officer V.F. Petrushevskii. It consisted of NG absorbed by powdered magnesit or magnesia. It was used in Siberia for blasting in gold mines (Ref 71, p 10 and Vol 5 of Encycl, p D1586-L)

1854. Epichlorohydrin was prepd by M. Berthelot (Ref 49, p 74)

1854. F. Pisani prepd 2,4,6-Trinitroaniline, also known as Picramide (Vol 1 of Encycl, pp A409-R & A410-L)

1857. Lamot du Pont introduced a new formula, less expensive BkPdr by replacing the Indian saltpeter (K nitrate) with the much cheaper Chile saltpeter (Na nitrate) (Vol 5 of Encycl, p D1587-L)

1858. Peter Griess discovered Diazocompounds (Ref 12, p 5) and in **1860** he prepd **Diazodinitrophenol**, also known as **Dinol** (Vol 2 of Encycl, p B59; Vol 5, p D1160-R and Ref 70, pp 99 to 102)

1858. Accdg to Marshall 1 (Ref 11, p 29), a Committee recommended the introduction of rifled ordnance into the British Navy, and from that time there has been rapid and continuous improvements in all sorts of guns. The introduction of the buffer has made the guns much steadier. Breech-loading guns were reintroduced, and the mechanism of breech greatly improved. To meet the requirements of the longer and more accurate cannons, the grains of Gunpowder were gradually increased in size so as to make them burn more slowly

1859. Ethyleneglycol, Ethylene Oxide and Ethyleneglycol Ether were prepd by Ch.A. Wurtz (Ref 49, pp 7, 74 & 114)

1859. Diethyleneglycol prepd simultaneously by A.V. Laurencó & Ch.A. Wurtz (Ref 49, p 158)

1859. Polyethyleneglycol was prepd by A.V. Laurencó (Ref 49, p 177)

1860. Baron von Lenk introduced bronze guns in Austria (Ref 11, p 40)

1860. Accdg to Gorst (Ref 71, p 7), rifled weapons started to be used in Russia

Note: British and French troops had such weapons already during Crimean War

1860 and After. Cannon Propellants. Up to about 1860's Black Powder was used exclusively as cannon and rifle propellant. Then attempts were made to replace it with smokeless proplnts made from incompletely colloided Nitrocellulose. These proplnts were too fast burning (See

descriptions under the year 1865). Some success was achieved ca 1882 by using Brown-, Chocolate-, or Cocoa Powder in larger caliber cannons. Their use was discontinued ca 1900, when fully colloided NC smokeless proplnts replaced them (Vol 2 of Encycl, pp C29-C30) (See also year 1888)

1861. Guanidine (Gu) was first prepd by Strecker (Ref 31a, p 374)

1861-1865. Period of American Civil War. Sometime prior to this, Gen Rodman invented *caseless propellant*, called "Mammoth", for use in cannons. It is briefly described in Vol 4 of Encycl, pp D754-R & D755-L

1862. John Tonkin of England proposed to pulp Guncotton using a beater similar to "hollander" of paper industry. This produced, after thorough washing with water, more stable NC than the unpulped material (Ref 31a, p 253 & Ref 44, p 242)

1862. Tonkin proposed using pulped NC as an ingredient of the following compn: Na nitrate 65, charcoal 16, sulfur 16 & NC 3% (Ref 31a, p 254)

1862 & 1863. Baron von Lenk took out patents in England in the name of Révy to protect his method of purification of Guncotton. A factory was erected in 1863 at Stowmarket to make GC by his method, but it soon exploded (Ref 11, p 40)

1863. Frederick Abel, the chemist of English War Dept, started experiments and manuf on a small scale of GC in the Royal Gunpowder Factory at Waltham Abbey and succeeded in obtaining by 1865 more stable product than that of von Lenk (Ref 11, p 40) (See also below under 1865)

1863. Accdg to Colver (Ref 12, p 18), Wilbrand was the first to prepare TNT, but it was not as pure as that of Hepp, prepd later (1880)

1863. Dioxane was prepd by A.V. Laurencó (Ref 49, p 119)

1863. Triethyleneglycol prepd by A.V. Laurencó & Ch.A. Wurtz (Ref 49, p 170)

1863. The 1st Nitroglycerin Plant was built by A. Nobel at Helenborg, Sweden. It blew up in 1864, killing the youngest Nobel and a chemist (Ref 58, p 126 & Vol 5 of Encycl, p D1586-R)

1864. After expln at Helenborg, Nobel was forbidden by Swedish Govt to build another plant near any habitation. So he constructed a small plant on a barge moored in the center

of Mällarsee (Ref 58, p 126 & Vol 5, p D1586-R)

1864. Baron von Lenk took out a US patent for manuf of his NC (Ref 11, p 40)

1865. Nobel obt'd permission of Ger Govt to construct a plant at Krümmel, near Hamburg (Ref 58, p 126 & Vol 5, p D1586-R)

1865. After obtg permission from Swed Govt, Nobel constructed a new plant at Vintervicken and another plant in Norway, which at that time was united with Sweden and Denmark (Ref 58, p 126 & Vol 5, p D1586-R)

1865. Jaworsky nitrated toluene with better results than did Mitscherlich in 1834 (Ref 12, p 18)

1865. Sir Frederick Abel of England proved that pulping followed by thorough washing (such as done by Tonkin) improved the stability of NC because it helped to remove traces of acids (and of other impurities) found inside the fibers. He also showed that pressing of pulped material into sheets, discs, cylinders and other forms would cause NC to burn less violently in the gun. The compressed blocks of Guncotton prep'd by him were an improvement over the yarn of von Lenk, but they still were too fast, not ballistically uniform and damaged the guns. The compressed blocks were, however, very suitable for blasting purposes (Ref 31a, p 254 & Ref 44, p 242)

1865. Prussian Officer Schultze invented a sporting prop'nt consisting of small pieces of nitrated wood previously treated by special process. The nitrated wood was washed with water contg small amt of Na carbonate, followed by conc'd sol'n of K & Ba carbonates and drying (Ref 31a, p 287 & Ref 44, p 242)

Note 1: Accdg to Marshall (Ref 11, p 47), the Schultze powder was the first successful smokeless powder

Note 2: A detailed description of "Sporting Smokeless Propellants" is given in Vol 2 of Encycl under "Bulk and Condensed Powders", pp B322 & B323-L

1865. Sir F. Abel patented a process for manuf of Guncotton, granulated by means of an aq sol'n of gum arabic. He also proposed to granulate mixts of Guncotton and Collodion Cotton using a small amt of methanol or eth-alc to gelatinize CC in the mixture (Ref 31a, p 254 & Ref 44, p 242)

Note: Sir Abel also later patented (in collabo-

ration with Dewar) a smokeless prop'nt described in Vol 1 of Encycl, p A1-R. Another Abel's smokeless prop'nt is listed on p A2-L

1866-1867. A. Nobel invented **Guhrdynamit** (Vol 5 of Encycl, p D1586)

1866-1867. Abel's "Researches on Guncotton" demonstrated that the material after proper purification is far more stable than thought to be. Moisture or exposure to sunlight did not harm it, and only exposure to elevated temp slowly decomp'd it. Abel found that in NC produced at Waltham Abbey by nitration with 18 parts of mixed acid, there was ca 1.62% soluble in eth-alc. He det'd its N content as 11.87%, while insol NC cont'd N=13.83%. He calcd that the highest nitrated substance must contain 14.14% N, as was previously suggested by Crum (Ref 31a, pp 255-56)

Note: Abel's researches were described more fully in JChemSoc 20, 310-57 & 505-76 (1867)

1867. Borlinetto proposed a mixt of PA (Picric Acid) 10 parts, Na Nitrate 10 & K Chlorate 8.5 parts as substitute for Gunpowder (Ref 12, p 7)

1867. Swed inventors J.H. Norrbm & C.J. Ohlsson proposed mixtures of pulverized AN with sawdust or charcoal as absorbent for NG (Vol 5 of Encycl, p D1587-R) (Also Ref 11, p 42)

1867. Swed inventor Björkmann patented the mixture called *Seranin* (Vol 5 of Encycl, p D1587-R)

1867. Abel's Stability Test using KI-starch paper is described in Vol 1 of Encycl, p A2-L. It was modified in 1907 by Dupré, becoming known in England as "Heat Test" (Ref 44, p 250)

1867. Abel of England and Trauzl of Austria proposed to replace kieselguhr with Guncotton as absorbent for NG. The resulting expl was exudable because GC was not gelatinized (Vol 5 of Encycl, p D1587-R)

1867. Nobel obt'd BritP 1345 covering the device called *fulminate blasting cap*, which cont'd MF (Mercuric Fulminate). This cap was crimped to one end of safety fuse and then inserted in Dynamite cartridge (Vol 5 of Encycl, p D1588-R) (See also Ref 12, p 4)

1868. A company was formed in England to manuf Schultze's sporting smokeless powder, invented in 1865, and a factory was constructed in 1869 at Eyeworth in the New Forest. The greatest success was achieved after the method

of prepn was modified by Griffiths. The powder was very popular with sportsmen on account of the light recoil and absence of smoke as compared with BkPdr (Ref 11, p 48)

1868. Schultze of Prussia patented the expl *Duanin*, consisting of NG and partly nitrated wood (Nitrolignin), but this mixt was exudable (Vol 5 of Encycl, p D1587-R)

1868. Accdgd to Dutton (Ref 58, pp 135–37), the first Amer Dynamite plant was constructed in California at a spot called Rock House Canyon near San Francisco. It was manned by Chinese, but supervisors were American. The plant, consisting only of shacks, was called "Giant Powder Co". Great opposition to Dynamite was encountered from a plant constructed at Santa Cruz, "The California Powder Works", manufacturers of BkPdr. When, however, the Great Comstock Lode was discovered BkPdr was found to be too weak to blow the hard rock of Mount Davidson and only Dynamite could do it. The increased demand made the management of Giant Powder Co push their Chinese workers harder and harder to meet the demand, and as a result of this hurry the plant blew up in Nov 1869, killing two Americans and all Chinese. This accident did not discourage the Nobel Co, and another larger and safer plant was constructed on the sand dunes south of what is now known as Golden Gate Plant. A large Chinese crew was assembled and a German chemist was sent from Europe as Superintendent. The first 23 years of Giant Company exemplify in dramatic terms the introduction of Dynamite in the US. During that period, five successive plants, each larger than the previous ones, were wrecked by explns and in all 83, mostly Chinese men died. This did not matter because the Giant Co's capital amounted to 2 million dollars

A detailed history of development and use of explosives in the US is given in the book of Van Gelder & Schlatter (Ref 14)

1868. E.A. Brown discovered that dry compressed Guncotton could be made to detonate very violently by initiation with a fulminate detonator such as Nobel already used for exploding NG. Shortly afterwards he made the further important discovery that wet Guncotton could be exploded by the initiation of a small quantity of dry Guncotton (the principle of the booster).

This made it possible to use large blocks of wet Guncotton in Naval mines with comparative safety (Ref 31a, p 256; Ref 44, p 242 & Ref 12, p 5)

Note: The compressed Guncotton contg about 18% moisture proved to be so successful that it was adopted by several countries (especially by Russia) for loading not only of sea mines but also of Whitehead torpedoes and cannon shells. Russian Artillery used it during the Russo-Japanese War (1904–1905), but it proved to be inferior to Japanese shells loaded with *Shimose* (cast Picric Acid). Senior author of this Encycl, who served in 1917 in the Russian Navy, remembers that torpedoes on his destroyer of 1905 vintage were loaded with compressed, moist Guncotton

1869. Nobel was granted Engl patent for use as absorbent for NG mixts of combustibles (woodmeal, charcoal, rosin, starch) with oxidizers (K or Na nitrates) (Vol 5 of Encycl, p D1588-L). The resulting expls are now known as Dynamites With Active Base

1869. Désignolle, Brugère and Abel recommended using salts of PA, especially K, Amm or Na Picrates in mixts with K nitrate and charcoal as proplnts and fillers for projectiles (Ref 12, p 6)

1869. Fontaine proposed a mixt of K Picrate and K Chlorate for loading torpedoes (Ref 12, p 6)

1869. Brugère proposed a mixt of Amm Picrate 54 & K Nitrate 46% for loading shells, while Abel recommended Amm Picr 40 & K Nitrate 60% (Ref 12, p 6)

1869. Beilstein & Kuhlberg investigated nitration of toluene with mixed nitric-sulfuric acid of various concns and isolated for the first time several isomers of mono- and dinitro-toluene. They also prepd in 1870 TNT, but did not prepare Trinitrobenzene. At about the same time, mono-, di-, tri- and tetra-nitronaphthalenes were prepd (Ref 12, p 18). Trinitrobenzenes were prepd in 1882 by P. Hepp

1870. J. Howden of San Francisco, Calif proposed replacing *Guhrdynamite* by a Dynamite consisting of NG 75 absorbed by 25 parts of a mixt consisting of pulverized sugar, K nitrate and Mg carbonate. This was known as Howden's Dynamite (Vol 5 of Encycl, p D1588-L).

1870. Nobel bought the patent of Norrbin & Ohlsson which covered the use of AN as an "active base". The patent also included the

expl contg AN 80, NG 10–14 & charcoal 6–10%. These expls became known as “*Ammonium Nitrate Dynamites*” (Vol 5, p D1588-L)

1870. Ethyleneglycol Dinitrate or Glycol Dinitrate, in pure state, was prepd by L. Henry (Ref 49, pp 130 & 148; Ref 70, pp 143–45; and Vol 6 of Encycl, pp E259-R–E266-L)

1870. 2,4,6-Trinitrobenzoic Acid and Its Salts were prepd by F. Tiemann & W.E. Judson (Vol 2 of Encycl, pp B73 & B74)

1870. Adoption by the Russian Armed Forces of the single-shot rifle invented by American General Berdan but not accepted by the US Govt. In its modified and simplified form it was used, under the name of *Berdanka*, for many years. It was partly replaced in **1891** (qv) by 5-cartridge rifle. (See Vol 2 of Encycl, p B101-R and Vol 4, p D756-L)

1870–1871. F. Volkmann obtd two Austrian patents for prepn of proplnt named *Collodine*. Its detailed description is given in Vol 3 of Encycl, p C394-L (Ref 44, pp 242–43)

Note: The patents on Collodine were classified by Austrian Govt, and its manuf by private plants forbidden. It was not until 1909 that its compn was published by O. Guttmann (1855–1910) (Ref 44, p 243 & Ref 11, p 48)

1871. Accdg to Marshall 1 (Ref 11, p 29), P (pebble) BkPdr was made by cutting large cubes from pressed BkPdr slabs

1871. Dr H. Sprengel, the inventor of vacuum pump, took out patents for a whole series of mining expls made by mixing together on the spot, just before the expl was required, an oxidizing substance with a combustible one. They were exploded by a fulminate detonator. As oxidizers he mentioned nitric acid and K chlorate and as combustibles carbon bisulfide, petroleum, Nitrobenzene, Nitronaphthalene and many other compds (Ref 11, p 43 & Ref 12, p 7)

1871. Sprengel reported that Picric Acid (PA) by itself could be detonated by means of fulminate, but this led to no practical results until E. Turpin started to use it beginning 1885 as filler for HE Shell invented by him (See under 1885 & 1843) (Ref 11, p 49)

1872. Accdg to Blasters' Hdb (Ref 62, p 4), Howden's Dynamite (See under 1870), which was stronger than Guhr Dynamite, was used in construction of Musconetcong Railroad tunnel, 1 mile long, near Easton, Penna

1873. Nobel obtd BritP 1570 for AN Dynamite, in which particles of AN were waterproofed by stearine, ozocerite, etc (Vol 5 of Encycl, p D1588-L)

1873. Sprengel reported that PA in conjunction with suitable oxidizer forms a powerful expl (Ref 31a, p 166). However, he did not apply his discovery to practice as did Turpin in 1885, who invented modern High Explosive Shell (Ref 12, p 1886)

1874. Accdg to info given in Encycl, Vol 2, p B46-R, Dinitrobenzenes became known

1875. After disastrous expln at the explosives plant of Messrs Ludlow at Birmingham, killing 53 persons, the Brit Govt, on recommendation of Col Sir V.D. Majendie, passed the “Explosives Act”, which established the Inspectors of Explosives who were given power to inspect all magazines and factories in order to see that operations are carried out in a reasonably safe manner. As a result, the number of deaths in expls factories was very greatly reduced. The provisions of the English Explosives Act of 1875 have been largely adopted by foreign countries, British Colonies and India (Ref 11, pp 46–47)

1875. Nobel obtd BritP 4179 which covered **Gelatins and Blasting Gelatin** (Vol 5, p D1588-L)

1876. Nobel proposed using as antifreezes in Dynamites: methyl-, ethyl-, amyl-, or isoamyl-nitrates, but these substances were too volatile (Vol 5, p D1589-L)

1876. Accdg to Gorst (Ref 71, p 10), it was decided in Russia to load artillery projectiles with compressed Pyroxylin contg 18–20% water. As the original method of loading proved to be unsatisfactory, it was necessary to develop a new method which was not completed until the beginning of 1890

1877. Nitroguanidine (NGu) was first prepd by Jousselin, but only beginning in 1900 did it start to be used in proplnts. During WWI NGu was used by the Germans as an ingredient of bursting charges (Ref 70, p 241 and Vol 6 of Encycl, p G158). It was used during WWII and later in triple-base proplnt **Gudol** (Vol 5, pp D1537 & D1538)

1877. A Commission was appointed in France to investigate the problem of ignition of *fire-damp*. In the report made in 1880, it admitted that there was then no explosive known that would not ignite fire-damp (called “coal-

damp" by Marshall (Ref 11, p 45)

1877. Wohlenberg & Sandström proposed o-MNT as an antifreeze, which proved to be better than those proposed by Nobel in 1876 (Vol 5, p D1589-L)

1877-1878. Accdg to Dutton (Ref 58, p 153), the Turks used, during Russo-Turkish War, the propellant prepd by treating NC with volatile solvent

1878. In order to deal adequately with the many new inventions relating to expls, the French Govt created the "Commission des Substances Explosives" and Prof M. Berthelot (1827-1907) was appointed as its President (Ref 11, p 45 and Vol 2 of Encycl, p B104-R)

1879. Tetryl or 2,4,6-Trinitrophenylmethyl-nitramine was first prepd by Michler & Meyer and studied in 1883 by van Romburgh, in 1886 by Mertens. It was not used as an expl until WWI (Ref 31a, p 175 & Ref 70, p 339)

1879. Hellhoff took out several Brit patents for Sprengel expls contg nitric acid either enclosed in glass tubes or absorbed in fossil flour or similar material (Ref 11, p 43)

1879. Compression (or Crusher) Test of Hess is described in Vol 3 of Encycl, p C492

1879. Nobel obtd patent covering Ammonium Nitrate Gelatins, known as **Ammongelatins**. This was the last patent granted to Nobel (Vol 5, p D1588-L)

1880. TNT (Trinitrotoluene), also called Trotyl, was made in very pure state by P. Hepp (Ref 11, p 265) (See also under the years 1891 & 1902 and Ref 12, p 18)

1880. The first du Pont NG & Dynamite plant, known as *Repauno Works*, was constructed at Gibbstown, New Jersey (Vol 5 of Encycl, p D1587-L)

Note: Accdg to Dutton (Ref 58, pp 141-43), the Repauno Plant manufd Dynamite until 1954, when it was converted to chemicals. There were in 1960 other du Pont Dynamite plants, the largest located on the Potomac River near Martinsburg, W. Virginia. It was operated by remote control robots

1880. S.R. Divine took out patents for Sprengel expls consisting of K chlorate & liquid combustibles. One of such expl, **Rackarock**, was used in 1885 for blasting of Hell Gate in New York Harbor (Ref 11, p 43)

1880. Tetranitrocarbazoles were first reported

by C. Graebe, and they were studied at Pica-tinny Arsenal in 1951 by S. Livingston and in 1952 by D.B. Murphy et al. The results of their studies were confidential at that time (Vol 2 of Encycl, pp C48-C50)

1880. Coal Mining Explosives, Testing for Per-missibility. It seems that the earliest tests were conducted in France, judging by the paper of E. Audibert, *AnnMines* 12, 278-98 (1937), but there seems to be no testing gallery until one was erected in 1907 at Liévin which was destroyed during WWI. The earliest gallery seems to have been erected in 1890 in England at Hebburn-upon-Tyne. This was followed by the gallery erected in 1891 in Austria at Mährisch-Ostrau. A brief description of gal-leries known to about 1965 is given in Vol 3 of Encycl, pp C370-C378

1881. Prismatic Gunpowder was manufd by molding hexagonal prisms of pdr and pressing them in a special press (Ref 11, p 29)

1881. Schultze's Smokeless Powder became very popular with sportsmen (See 1868), and it was decided to construct another factory. This factory at Hetzbach in Hesse-Darmstadt was completed in 1883 (Ref 11, p 48)

1882. The next successful smokeless propint was developed at the Explosives Co, England and became known as "EC Powder" (Ref 11, p 48). Its compn and props are described in Vol 5, pp E6-R to E8-R

1882. Brown or Cocoa prismatic powder was made by the Germans, and in spite of attempts to keep the method of manuf secret, it was being made in England at Waltham Abbey two years later (Ref 11, pp 29-30) (See also Vol 2 of Encycl, p B173-L)

1882. The size of cannons greatly increased and at the bombardment of Alexandria, the British had 16-inch cannons weighing 80 tons each. Such weapons required very dense and very large grain powder (Ref 11, p 30)

1882. W.F. Read & D. Johnson patented in Germany a sporting propint prepd by agglomerat-ing and hardening the NC grains by moistening their surface with eth-alc. This propint was adopted in England by the Explosives Company at Stowmarket, England and manufd under the name of "EC Powder". It proved to be suc-cessful and was used for many years not only in shotguns but also as EC Blank Fire Powder

(Ref 31a, p 289; Ref 44, p 243 and Vol 5 of Encycl, pp E6-R—E8-R)

Note 1: Accdg to Marshall (Ref 11, p 48), the pdr was very successful and a separate company was formed which constructed a factory at Green, near Dartford in Kent

Note 2: Powders of von Lenk, Schultze and EC were too quick for use in rifled firearms. For this purpose it has been found necessary to destroy entirely the structure of the original cellulose by thoroughly gelatinizing it

1882. P. Hepp prepd 1,2,4-Trinitrobenzene and 1,3,5-Trinitrobenzene, while 1,2,3-Trinitrobenzene was prepd in 1914 by G. Körner & A. Contardi (See Vol 2 of Encycl, pp B48 & B49)

1882. After introduction of rifled cannons by French and British during Crimean War (1853—1856), it was found by the Germans that ordinary BkPdr is too quick for larger caliber weapons. After prolonged research, the prismatic brown powder, C/82, made from partly carbonized charcoal, was introduced (See also Vol 5 of Encycl, p D1580-R, under Duttenhofer). Then the Russians introduced in 1886 a brown pdr contg 19.6% of partly carbonized rye straw, 78.4% K nitrate and 2% sulfur (Vol 2 of Encycl, p B173-L)

Note: The above description was only partly reported by P. Tavernier in Ref 44, pp 243—44

1883. Prepn of *Tetryl* (or *Tetralite*) was first described by van Romburgh in *RecTravChim* 2, p 108. Quoted from Marshall 1 (Ref 11, p 274)

1883—1884. M. von Duttenhofer (1843—1903) nitrated brown charcoal (used for prepn of C/82) by Schultze's method to obtain colloided rifle powder RCP (Rottweiler Cellulose Pulver) which was adopted by the German Army in 1884, but its compn was kept secret until 1887 (See also Vol 5 of Encycl, p D1581, under "Duttenhofer's Smokeless Propellant") (Ref 44, p 244)

1884. **Ammonites** are expls consisting of AN and nitrated derivatives of naphthalene. The original expl was known in England as "Miner's Safety Explosive". Some Ammonites contd TNT and were used for military purposes. A detailed description is given in Vol 1 of Encycl, pp A307-R to A310-L. Some Ammonites used by Germans during WWII as Substitute (Ersatz) Explosives contd RDX. They are listed in PATR 2510 (1958), p Ger 44 and on p E122 of Vol 5 of Encycl

1884—1896. Nearly simultaneously and independently of Max von Duttenhofer, Paul Vieille of France (1854—1934) invented in 1884 a completely colloided single-base NC propellant. Originally called "poudre V" (V stands for Vieille). It was renamed "poudre B" in honor of General Boulanger, then Minister of War. It was adopted in 1886 for military rifles as BF (poudre B à fusil), in 1888 for field cannons as BC (poudre B à canon de campagne) and in 1896 for marine cannon as BM (poudre B de marine). These propellants and their modifications were used as late as WWII (See also Vol 2 of Encycl, pp B1 & B2 and C32-L) (See also Ref 31a, pp 292—94; Ref 44, p 244 & Ref 11, p 49)

1884. **1,3-Diamino-1,3-trinitrobenzene** first prepd by Noelting & Collin, was also prepd in 1888 by Barr and in 1902 by Blanksma (Ref 70, pp 95—98 and Vol 5 of Encycl, p D1130-R)

1885. Prussian Govt established at Neunkirchen the first testing station for investigating mining explosives, which included a testing gallery. The method was soon adopted by other countries (Ref 11, p 45)

Note: Such galleries and method of testing are described in Vol 3 of Encycl, pp C368-R to C378-L. See also Naoum (Ref 16, p 396)

1885. Accdg to Colver (Ref 12, pp 5, 7, 11 & 12), the discovery by French scientist E. Turpin (1848—1927) of detonating properties of PA (Picric Acid), was followed by its adoption for filling HE shell of his design (See next item)

Note: Accdg to Marshall (Ref 11, p 44), H. Sprengel was the first to draw attention to the fact that PA by itself could be initiated by a powerful detonator and was a very powerful expl, but no practical use was made of his discovery (See year 1873)

1885. In this year, the French Govt adopted the HE Shell designed by E. Turpin, using as a filler Picric Acid, designated as Mélinite. Its construction was essentially the same as modern High Explosive Shell. It is described on p 11 of Ref 12 and illustrated there, but not reproduced here

Following is a historical development of projectiles given by Marshall 1 (Ref 11, pp 30—1):

The first projectiles used were made more or less like arrows with metal "feathers" and metal arrow-heads. They were soon found unsuitable and replaced by round shot made of stone, lead, iron or bronze. All these materials remained in use for several centuries, but stone was mostly used for large cannons. This was because it is less expensive than metal and also because the barrels of early cannons would not stand the strain of discharging heavy materials. Lead and iron bullets were usually employed in small arms. Attempts were made very early to throw from cannons incendiary missiles such as had been previously discharged from catapults, etc. In order to prevent the extinguishing of flame during flight, the projectiles (mostly stones), smaller than the bore of the cannon, were smeared over with incendiary matter and wrapped in cloth soaked in the same material. This method was used in 1469 at the siege of Weissenburg. Another incendiary, the "red hot shot", was dangerous to use because it could ignite prematurely the powder charge in the gun. This difficulty was overcome in 1579 when Stephen Batory, King of Poland, placed a thick wet pad on top of powder charge prior to introducing the hot-shot. Hot-shots were used with great effect by the English in the defense of Gibraltar in 1782.

Hollow projectiles (shells) filled with BkPdr could not be made until casting of metal was developed. But a sort of weak shell was made of earthenware, or by joining two metal hemispheres. These were filled with a slow-burning powder well rammed, and provided with an igniter, which was lighted by the flame of propelling charge, and burned for a few minutes before reaching the charge in the shell. Better results were obtained with an igniter, invented in 1588 (qv), or with fuse invented by Bickford in 1831 (See Vol 2 of Encycl, p C112-L). The shells for early muzzle-loading rifled cannons were provided with studs to fit into rifling and with copper plates (gas-checks) over the base to prevent the escape of gases past the shell. For some of the early rifled breech-loading guns, the shells were coated with lead, but now they are provided with copper bands near the base to take the rifling and prevent escape of gases. Originally shells were filled with BkPdr, but now they are filled with HE's, such as TNT, Comp B, etc

1885-1886. Accdg to Colver (Ref 12, p 14), three varieties of PA expls, invented by E. Turpin, were introduced in France. The first variety known as *Explosif de Turpin* consisted of powdered PA either pressed alone, pressed with the addn of soln of a binder (such as gum arabic or collodion), or by pouring the molten material into containers of suitable form. Almost as soon as PA was introduced for military purposes, a mixt of 70 parts PA & 30 of Guncotton dissolved in 45 parts of acetone (or ether-alcohol) was used under the name of **Mélinite**. This was 2nd variety. Then later Guncotton was discarded and straight PA was heated at 130-135° and poured directly into shells. This was the 3rd variety, and the name was Mélinite (called Lyddite in England). The tests conducted in 1892 at LeBouchet showed that shells loaded with cast PA were safe and very powerful

Mélinite (PA) was used in France for more than 25 years, and only during WWI was it replaced by TNT (Trotyl, in Fr)

Note 1: Since the mp of PA is relatively high (122.5°), the pouring process required to melt PA to that high temp was rather dangerous. Various additives have been suggested to lower the mp. Several low mp mixts were suggested by Girard, and four of them are listed in Colver on p 15. Most interesting of them is: PA/TN-Cresol in molecular proportion 1:1. Its mp is 78°

Note 2: PA is very poisonous and it dyes skin yellow, and this is hard to wash out. These were probably the reasons why PA was eventually replaced by other HE's, such as TNT, PETN, RDX, etc

1886. Brown or Cocoa Powder was manufd at Okhta Plant, near StPetersburgh, Russia (Vol 2 of Encycl, p B173-R)

1886. Accdg to Gorst (Ref 71, p 14), I.M. Chel'tsov proposed to load shells and mines with a mixt of AN 72.5 & AmmPicrate 27.5%, named by him *Gromoboy*

1886. The British had 16.25-inch cannons weighing 110 tons which required very dense, very large grain BkPdr, but it was soon replaced by smokeless powder (called now smokeless propellant). With this propellant it was possible to propulse a shell weighing a ton a distance of 20 miles (Ref 11, p 30)

1887. P. Vieille devised in France the stability test known as "l'épreuve à 110°C de Vieille" (l'épreuve au première rouge), but it proved to be of no practical value until it was modified by Commandant Lepidi and became known as "l'épreuve à la résistance totalisée" (Test for Total Resistance). Both of these tests, of which the 2nd test became French official, are described in Vol 1 of Encycl, p XXI, under "Resistance to Heat Test"

1887. Another Commission was appointed in France to inquire into coal-mine explosions. Influenced by Berthelot's work and theories, its attention was directed to the question of the heat evolved by an explosive and the resulting temperature of the products (Ref 11, p 45)

Note 1: As a result of the work of the Commission, a max temp of 1500°C for expls used in coal layers (explosifs grisou-couche) was established; and 1900°C for expls used for blasting rock in gaseous coal mines (explosifs grisou-roche) (Vol 3 of Encycl, p C369-L)

Note 2: Methods of calculating heat and temp of expln are described in Vol 3, pp C447-C449)

1888. In Germany and in England it was recognized that the temp of expln is only one of the factors in making an expl safe or dangerous to use in fiery mines. Consequently, reliance has been placed more upon testing in galleries, which are intended to imitate as nearly as possible conditions in the mines. The Committee was appointed in England in 1888 and a trial gallery at Hebburn Colliery completed in 1892 (1890?). After experimenting with various expls until 1895, the use of several expls, mostly based on AN (Ammonium Nitrate) was recommended. Based upon the results obt'd by this Committee, the Coal Mines Regulation Act of 1906 was founded. Following this Act, a gallery was constructed at Woolwich Arsenal and another more lately at Rotherham (Ref 11, p 46)

Note: More detailed description of this subject is given in Vol 3 of Encycl, pp C372 & C373)

1888. Cyclotrimethylene Trinitrosamine was discovered simultaneously by Griess & Harrow and by Mayer. It was studied in 1895 by Duden & Scharff and in 1896 by Delépine (Ref 70, pp 86-90). It was used during WWII in Germany under the name R-Salz (PATR 2510, p Ger 170-L). See also Vol 3 of Encycl, p C633

1888. Munroe-Neumann Effect or Shaped Charge Effect was accidentally discovered by C.E. Munroe of the US, but was not put to practical application until 1910 when C.E. Neumann of Germany proposed using the effect in the manuf of explosive ammunition (Vol 4 of Encycl, pp D442 to D454)

1888. PA (Picric Acid) was adopted by the German Govt, under the name **Granatfüllung 88** (Gfg 88). It consisted of PA pressed in cardboard or metal containers. It was used for filling shells, land mines, depth- and demolition charges. It was used as late as WWII, under the name **Füllpulver 88**, listed in PATR 2510, p Ger 46-R (1958), as Filler No 2

1888. Triaminotrinitrobenzene was first prepd by Jackson & Wing. More recently (1928), it was prepd by Flürscheim & Holmes (Ref 70, pp 364 to 366). Its uses are not indicated in Ref 70

1888. PA was adopted in England under the name of Lyddite (Ref 11, p 50); then later in Italy as **Pertite** and in Japan as **Shimose** (Ref 21, p 386)

1888. Alfred P. Nobel (1833-1896), famous scientist (born in Sweden, raised and educated in Russia, and worked in Sweden, Germany & USA), prepd a double-base smokeless proplnt by replacing camphor of *Celluloid* (Vol 2 of Encycl, p C95-L) with NG. He called the proplnt **Ballistite**. In 1889 he prepd Ballistite directly from Collodion Cotton (Vol 2 of Encycl, p C103) and NG using the "solventless" method of Lundholm & Sayers. More detailed description is given in Vol 2 of Encycl under **Ballistite** on pp B8-B9 (See also Vol 3, p C400 and Ref 31a, pp 293-95).

1888. Dr W. Kellner prepd in the laboratory of F. Abel the double-base proplnt **Cordite** (See Vol 3 of Encycl, p C532-L)

1889. **Cordite**, the 2nd successful double-base propellant, was patented for the British Government by F. Abel & J. Dewar and adopted as a military proplnt. It was Cordite Mark 1 or CSP₁ (Cordite Smokeless Powder) (See Vol 3 of Encycl, p C532-L; also Ref 31a, p 295 & Ref 44, p 246)

1889. A. Nobel proposed using DPhA (Diphenylamine) as stabilizer for his Dynamite (Ref 44, p 250)

1890. Accdg to Dutton (Ref 58, pp 144-46),

attempts to use Dynamite as bursting charge in artillery shells were unsuccessful, because it blew up inside the barrels, thus destroying them and wounding or killing personnel. In order to reduce the muzzle velocity, pneumatic cannons operated by compressed air were invented. Here the Dynamite shell was propelled with lower velocity than possible in using a propellant. At that time Americans were still using a brown variety of BkPdr, while all European countries switched to smokeless propellants. In 1890, the US Navy built the ship USS Vesuvius which had mounted on her bow three monster air cannons which hurled shells weighing a thousand lbs each and contg 600 lbs of Dynamite with some NC. An electric storage battery inside each shell ignited, on impact, NC which detonated the Dynamite. Great things were expected of Vesuvius when in 1898 it attacked Santiago, Cuba, but they were not fulfilled because the range of air-cannons, 1 mile, was shorter than the range of battery at the fort of Santiago. After this the US Congress decided to remove the air-cannons

1890. Hydrogen Azide and Hydrazoic Acid were first prepd by T. Curtius and then investigated by D. Mendel'eff (Vol 1 of Encycl, pp A537-R to A542-R)

1890. Tetranitrocarbazole, first prepd by C. Graebe. A better method was developed in 1912 by Casella Co, and this method is still used. TeNCbz is suitable as component of igniter and pyrotechnic compns (Ref 70, pp 328-30)

1890. Cuprous Azide was first mentioned by T. Curtius in Ber 23, 3023, but was not properly investigated. History of later work is given in Vol 1 of Encycl, p A534

1890. A. Wohl proposed polymerized glycerin as a gelatinizer for Dynamites, but it was not very satisfactory because it diminished strength & brisance of Dynamite, made it too difficult to detonate and affected adversely its oxygen balance (Vol 5 of Encycl, p D1589-L)

1890-1891. Mercurous Azide was prepd by T. Curtius (Vol 1 of Encycl, p A591)

1890-1891. Silver Azide was prepd by T. Curtius (Vol 1 of Encycl, p A598)

1890-1891. Sodium Azide was prepd by T. Curtius (Vol 1 of Encycl, pp A601 & A608)

1891. Hydrazine Azide was prepd by T.

Curtius (Vol 1 of Encycl, p A536)

1891. Lead Azide was first prepd by T.

Curtius (Vol 1 of Encycl, p A545)

1891. Ch.E. Munroe of the US prepd a double-base proplnt, **Indurite**, by gelatinizing Guncotton with about an equal amt of Nitrobenzene. Indurite was not found suitable for use in cannons (See Vol 2 of Encycl, p C32-L and Ref 31a, p 296 & Ref 44, p 246)

1891. C. Häussermann with the Griesheim Chemical Plant began the manuf of TNT, formerly (in 1880) prepd by Hepp in the laboratory. In 1901 the manuf was begun by the Carbonite Co and some expl firms soon followed. The first country to adopt it for military purposes was Germany (1902), as *Sprengmunition 02*. Other countries soon followed, such as Italy (1907), under the name *Tritolo* and Russia (1909), under the name of *Trotil*. In the English Service it was formerly known as T.N.T., but later as *Trotyl*. In the US it is called TNT and was adopted for military purposes in 1912 (Ref 11, p 265; Ref 18, p 20; Ref 64, p 2-4 (L) and Ref 71, p 12). It started to replace Mélinite in France as a bursting charge just before WWI

1891. D.I. Mendel'eff (Mendeleev) of Russia (1834-1907) invented, quite independently of Vieille (who kept secret his poudre B), a completely colloid smokeless proplnt prepd by gelatinizing with eth-alc the NC of N 12.44%, which contained sufficient oxygen for complete combustion to CO & water. He called the proplnt *Pirokolodion* (Pyrocollodion). It was adopted as "service" proplnt in newly developed, by Mossin and Nagan, cal .30 (7.62mm), 5-cartridge rifle called "Trekhlneyaya Vintovka" (Three-Line Rifle) (See Ref 51, pp Rus 22-R & Rus 23-L and Vol 2 of Encycl, p C32-L where the N content of Pyrocollodion is erroneously given as 13.44 instead of 12.44%)

Note: P. Tavernier did not say in his description in Ref 44, p 246, that Mendel'eff prepd, independently from Vieille, a NC contg 12.44% N and named it *Pirokolodion* (Pyrocollodion), but said further that Lt Bernadou patented a single-base proplnt contg at first CP₂ with 12.45% N and later pyrocollodion with N=12.60%. All this is wrong. Lt Bernadou did not know the compn of French CP₂, but he knew the compn of Mendel'eff's Pyrocollodion,

which was only similar to CP_2

Accdg to the books of: Lt John B. Bernadou, US Navy (1858–1908) (Ref 2a) and of Van Gelder & Schlatter (Ref 14, p 812–21), also listed in Vol 2 of Encycl, p B104 and described on p C32-L, Lt Bernadou, while serving as US Naval Attaché in StPetersbourg, learned in 1895 the method of prepn of Mendeléef's proplnt (He did not know the secret of Vieille's "poudre B") and decided to introduce it in Amer Navy in preference to Indurite. After investigating ballistic properties of Pyrocollodion, Bernadou found that better ballistic props as a cannon proplnt could be obtd if N content of NC were raised from 12.44% to about 12.6%. He gelatinized NC with eth-alc and called the resulting proplnt "Pyrocellulose Powder" or simply "Pyro". It was adopted in 1897 by the US Navy and used in 1898 during Spanish American War. US Army adopted "Pyro" in 1899. Large scale manuf began in 1900 at a newly built "US Naval Powder Plant", Indian Head, Md (now known as US Naval Ordnance Station). Picatinny Arsenal, Dover, NJ, started its manuf in 1907 (Ref 31a, p 297)

Note: Dutton (Ref 58, p 154) stated that Russia rearmed its Army in 1896 with Mendeléef's propellant and that this proplnt modified by Lt Bernadou was adopted in 1901 by the US Govt

1891. It is the year of introduction by the Russian Armed Forces of 5-cartridge, cal 7.62mm rifle invented by Mossin and Nagan. It is known as *trëkhlineynaya vintovka* (three-line rifle). It is briefly described in ArmyOrdn 30, 83–85 (1946) and in PATR 2145 (1955), pp Rus 22-R & Rus 23-L

1892. Tetranitroöxanilide was prepd by A.G. Perkin and used as a component of BkPdr type expls and of pyrotechnic compns (Ref 70, pp 331–34) (See also Hexanitroöxanilide)

1892. Hexanitroöxanilide was first prepd in England by A.G. Perkin. Used in pyrotechnic compns (Ref 70, pp 170–72)

1892. Aminoguanidine and Derivatives were first prepd by J. Thiele (Vol 1 of Encycl, p A210) (See year 1928 for Nitraminoguanidine and Its Salts)

1892. Zinc Diazide was prepd by W. Wislicenus and in 1898 by T. Curtius & J. Rissom (Vol 1 of Encycl, p A624)

1892. Ecrasite (Ekrasit) started to be used by

Austro-Hungarian Army and this lasted until 1918, when its entire supply was blown up in Kiév, Russia. Its compn was never officially revealed, but it was suggested that it was either straight Ammonium Trinitro-m-cresylate (*Cresylite*) or its mixt with PA. More information on this subject is given in Ref 11, p 17 and in Vol 5 of Encycl, pp E8-R to E9-L

1892. 5-Amino-1H-tetrazole was first prepd by J. Thiele and examined in 1954 by L.F. Audrieth & J.F. Currier at Univ of Illinois and by D.B. Murphy, J.P. Picard, P. Rochlin & S. Helf at Picatinny Arsenal. Was recommended as cooling agent in proplnts. Its salts and nitrated derivatives are explosive (Vol 1 of Encycl, pp A258-L to A260-R) [See also 5-Nitroaminotetrazole of Lieber, p A260-L]

1894. Styphnic Acid(2,4,6-Trinitroresorcinol) was first prepd by Hauff (Ref 11, p 281)

1894. Tetryl (or Trinitrophenylmethylaniline), first described in 1883 by van Romburgh was commercially manufd in Germany and tested as to its usefulness by military authorities (Ref 12,, p 27)

1894. Hydrazine, Anhydrous was prepd in 1894 by Lobry de Bruyn, but its salts were prepd in 1875 by Emil Fischer, who coined the name "hydrazin". Its derivs were investigated during WWII by Col L.F. Audrieth. More information is given in this Volume under Hydrazine and Derivatives

1894. Mercuric Azide was prepd by M. Berthelot & P. Vieille (Vol 1 of Encycl, p A590)

1894. Accdg to Gorst (Ref 71, p 11), attempts to use Melenit (Russ name for PA) in shells of cannon type 1877 were unsuccessful and the idea was abandoned

1894. Butanetriol Trinitrate was first prepd by Wagner & Ginsberg. A new method of prepn was devised in 1948 by the US Rubber Co, and its props were evaluated in 1948 by the US Naval Powder Factory. Used as expl plasticizer for NC (Ref 70, pp 40–42)

1895. The Ammonium salt of Hexanitrodi-phenylamine, known as yellow dye "Aurantia", manufd by the Chemische Fabrik Griesheim, proved to be a valuable explosive (Ref 12, p 25)

1895. Adoption by the Russian Govt of modified revolver Nagan, invented in 1880's by Nagan. It is a 7.5mm (0.295-inch) weapon using 5 cartridges with bullets hidden in them.

It is described, with illustration of its cartridge, in PATR 2145 (1955), p Rus 11-R

1896. The AB Bofors, Nobelkrut of Sweden patented a smokeless propellant which was prepd by glueing and compressing together several layers of different components. The outer layers were slow burning, while the speed increased progressively towards the inner layers (Ref 44, p 246)

1896. Introduction by P. Vieille of 2% amyl alcohol as stabilizer for smokeless propellant did not produce satisfactory results, especially in cannons of large caliber, and the amount was increased in 1906 to 8%. Nevertheless, two disastrous explns took place on battleships *Iéna* in 1907 and *Liberté* in 1911. Both explns were ascribed to spontaneous ignition of poudre BAm stored in their powder magazines (Ref 44, p 248 & Ref 31a, p 308)

1897-1898. It is presumed that Research Establishment at Spandau, Germany, proposed to treat grains of small arms' proplnts on the outside with slow-burning substances like camphor. Such proplnts were progressive to a certain extent. The GerP 120201 of 1898 proposed treating grains of NC with aromatic nitrocompds, such as DNT (Ref 44, p 246)

1897-1898. Cheddites were invented in 1897 by E. Street of England, and several varieties of original compn were patented in 1898. A detailed description with several tables is given in Vol 2 of Encycl, p C155 to C164

1898. Cadmium Diazide was prepd by T. Curtius & J. Rissom (Vol 1 of Encycl, p A526)

1898. Calcium Diazide was prepd by T. Curtius & J. Rissom (Vol 1 of Encycl, p A527)

1898. Chromium Triazide was prepd by T. Curtius & J. Rissom (Vol 1 of Encycl, p A530)

1898. Cobalt Triazide was prepd by T. Curtius & J. Rissom (Vol 1 of Encycl, p A531)

1898. Cupric Azide was prepd by T. Curtius & J. Rissom (Vol 1 of Encycl, p A532)

1898. Iron Azide or Ferric Triazide was prepd in soln by T. Curtius & J. Rissom, but it was not until 1917 when L. Wöhler & F. Martin prepd it again and isolated it (Vol 1 of Encycl, pp A543-L to A544-L)

1898. Lithium Azide was prepd by T. Curtius & J. Rissom (Vol 1 of Encycl, p A588)

1898. Manganese Diazide, Basic was prepd by T. Curtius & J. Rissom, and then in 1900 T.

Curtius & A. Darapsky prepd $Mn(N_3)_2$ (Vol 1 of Encycl, p A590)

1898. Nickel Diazide, Basic was prepd by T. Curtius & J. Rissom, and then in 1900 T.

Curtius & A. Darapsky prepd $Ni(N_3)_2$ (Vol 1 of Encycl, p A593)

1898. Potassium Azide was claimed to be prepd by L.M. Dennis & C.H. Benedict, and in the same year by T. Curtius & J. Rissom (Vol 1 of Encycl, p A595)

1898. Rubidium Azide was first prepd by L.M. Dennis & C.H. Benedict and also by T. Curtius & J. Rissom (Vol 1 of Encycl, p A596)

1898. Strontium Diazide was prepd by the same persons as above (Vol 1 of Encycl, p A620)

1898. Thallium Azide was prepd by the same persons as above (Vol 1 of Encycl, p A622)

1898. Azotetrazole was prepd by J. Thiele, and its expl salts were recommended by E. von Herz and by H. Rathsburg for use in detonators. Its derivatives were described by L.F. Audrieth & J.F. Currier in Univ of Illinois Rept, "Derivatives of 5-Aminotetrazole", pp 22-23 (1954) (See Vol 1 of Encycl, pp A659 & A660)

1898. Simon Thomas developed stability test, which is described in Ref 28a, p-80). It was modified in 1920 and became the "Dutch Test" or "Loss of Weight Test", described in Vol 5 of Encycl, p D1580-R

1899. Potassium Dinitrobenzfuoxan, first prepd by P. von Drost, was examined at PicArns in 1954 and 1955. It is used in priming compns (Ref 70, pp 302 to 305)

1899. Cyclotrimethylenetrinitramine called RDX or Cyclonite, was first prepd by Henning of Germany and he named it **Hexogen**. He used it for medical purposes. Then Brunswick prepd it in 1916, but it was E. von Herz who recognized in 1920 its value as an expl. The first one who prepd it in fairly good yield was G.C. Hale of Picatinny Arsenal (in 1925). Then nothing was done until 1940 when J. Meissner of Germany developed a continuous method of manuf. In 1940, Drs Ross & Schiessler of Canada developed a process which did not require the use of hexamine as a starting material, but the most important work on manuf and investigation of RDX was done by W.E. Bachmann. Four methods of manuf of RDX were developed in Germany (Vol 3 of Encycl, pp

C611 to C626). Expl mixtures based on RDX are described on pp C626 to C630. See also Ref 70, pp 69-75

1899. Oxyliquit, invented by Linde, consisted of liquid air (or oxygen) absorbed in wadding, charcoal or other org material. As these mixts were hard to detonate, kieselguhr was substituted as absorbent with an addn of petroleum. It was inconvenient to use, as the cartridge had to be fired within 5 to 15 mins of its prepn. It was tried in Austria and used in construction of the Simplon tunnel (Ref 11, p 44)

1899. Aluminized Explosives. The addn of Al to increase the performance of expls was first proposed by R. Escales of Germany and patented in 1900 by G. Roth. For more details see Vol 1 of Encycl, pp A146 to A151

1899. Ammonal, originally contg AN, charcoal & Al was proposed by R. Escales and patented in 1900 by G. Roth (Vol 1 of Encycl, p A287) (See also year 1917 for Austrian Ammonal T)

1899. Tritonal 80/20 (TNT 80 & Al 20%) was developed in the US as filler for bombs. The addn of Al to expls was proposed in 1899 by Escales and patented in 1900 by Roth, but it was not properly investigated until 1943 and 1944 at PicArns by W.R. Tomlinson Jr and proposed as filler for bombs of high blast effect (Ref 64, pp 7-68 & 7-69 and Ref 70, pp 386-90)

1900. It was proven during South African War (1899-1902) that Brit proplnt **Cordite Mk 1**, which contd 58% NG, caused very excessive erosion in gun barrels. As a result of this, the amt of NG was reduced to 30%, NC was increased to 65, and mineral jelly was 5% (Ref 44, p 247 & Vol 3 of Encycl, p C532-L)

1900. It was also shown during South African War that shells loaded with **Lyddite** (Engl name for PA) were less satisfactory than those loaded with Black Powder. This was caused by incomplete deton of PA, which was attributed to the faulty construction of detonators (Ref 71, p 11)

1900 is the year of discovery by the Badische Anilin- und Sodafabrik of "contact process" for manuf of strong sulfuric acid and oleum, which was less expensive than the chamber method. As such acid was required for mixed nitric-sulfuric acid to nitrate aromatic hydro-comps to tri- or higher states, Trinitrobenzene

and Trinitrotoluene could be inexpensively manufd (Ref 12, p 17)

1900. Germans started to use in their NC rifle proplnts either 0.5 or 1.0% DPhA as a stabilizer (Ref 44, p 250)

1900. Barium Diazide was prepd by T. Curtius (Vol 1 of Encycl, p A523-L)

1900. Konovalov of Russia prepd some expls by laboratory nitration of aliphatic derivs of petroleum, using weak nitric acid under pressure, but the yields were poor (Ref 12, p 29)

1900. Accdg to Gorst (Ref 71, p 15) it was proposed in Russia to replace MF (Mercuric Fulminate) detonators with those in which 3/4 of MF was replaced by Tetryl or Trotil (TNT)

1900. Chromatography, a physical method of separation in which the components are partitioned between two phases, was invented simultaneously and independently by American geologist D.T. Day and Russian botanist M.S. Tsvet (Tswett). Their methods and later modifications are described in Vol 3 of Encycl, pp C289 to C298. Qualitative method of separation of ingredients by adsorption was known for centuries. This is described on p C289-R

1901. Hexanitrobiphenyl was first prepd by F. Ullmann & J. Bielecki (Vol 1 of Encycl, p B124)

1901. Accdg to Colver (Ref 12, p 21), manuf of TNT by the method of P. Hepp, as improved by C. Häussermann, was conducted in 3 stages: 1) Nitration of toluene to MNT, using relatively weak spent mixed acid; 2) Nitration of MNT to DNT using stronger acid and 3) Nitration of DNT to TNT using strong acid with oleum. This method, which proved to be more economical than direct nitration of Toluene to TNT, was used in the US until WWII, when Dr I.A. Grageroff introduced the so-called "reverse process". This method was twice as rapid. Many plants switched to Continuous Methods (See Vol 3 of Encycl, p C505)

1901. Accdg to Colver (Ref 12, pp 20 & 24), German expls industry unreservedly adopted the manuf of TNT, mostly by the method of Hepp as improved by Häussermann (See above). Some factories used their own modifications and used names, such as Trotyl, Trynol, Trolit, etc. The names *Triplastit* and *Plastrotyl* were used for TNT worked-up with DNT, MNT and a small amt of NC

1902. Accdg to Colver (Ref 12, p 23), Germany was the first country to adopt TNT for military purposes, mostly as filler of HE shells. Its official name was **Füllpulver 02 (Fp 02)**. It is listed in PATR 2510 (1958), p Ger 46-R as Filler No 1

1902. Dr Edeleanu & G. Filiti of Rumania took out a patent for manuf of nitrocompounds from petroleum, but they found no practical application (Ref 12, p 27)

1902. Germans proposed using cyanamide, dicyandiamine or tricyandiamine as auxiliary stabilizers in their proplnts (Ref 44, p 251)

1902. Introduction of Bergmann-Junk Stability Test. It is described in Vol 2 of Encycl, pp B102-R to B103-L (See also Ref 44, p 251)

1902. Accdg to Colver (Ref 12, p 23), Germans also used TNT for demolition purposes, under the name **Sprengmunition 02**. It replaced

Sprengmunition 88, which was PA (Picric Acid)

1902. **Cordeau détonant**, developed in France, was improved in 1907 by L. Lheure. This type of cordeau was introduced in 1913 in the US by the Ensign-Bickford Co (Vol 3 of Encycl, pp C530 & C531). Addnl info is given on pp D103 to D106, under Detonating Cords or Detonating Fuses

1903. Accdg to Tavernier (Ref 44, p 252), Rottweil Fabrik of Germany proposed vaseline with 1-2% Na bicarbonate as muzzle-flash suppressor. This was replaced in 1907 by soap or rosin

1903. Until this year no satisfactory **antifreeze** for NG was found, and many industrialists preferred not to use any of those previously proposed, but let ordinary Dynamite be defrosted in winter. The disastrous expln of 1902 in Greisenau Mine, Germany, took place during defrosting of Dynamite and encouraged the renewal of research on antifreezes. In 1903 the SA de Poudres et Dynamites of France introduced DNT and TNT as antifreezes. They did not lower the fr p of NG sufficiently. The Glycerin Dinitrate (GDN) proposed in 1903 by A. Mikolajczak in Gelatin Dynamite was not very satisfactory because it lowered the strength of Dynamites too much (Vol 5 of Encycl, p D1589-L)

1904. The Dynamit AG of Germany proposed DNCH (Dinitrochlorohydrin) as an antifreeze. This compd was satisfactory, except that it

produced very noxious fumes contg chlorine

1904. **2,3,5,6-Tetranitroanisole** was prepd by J. Blanksma (Vol 1 of Encycl, p A454-R)

1904. Introduction of Obermüller Stability Test which consists of heating 1 to 2g NC in a small tube under vacuum at 135-140° and measuring the pressure of evolved gas by vacuum manometer (Ref 38a, pp 87-88)

1904-1905. **2,4,6-Trinitroanisole** or **Methyl Picrate** was patented for use in smokeless proplnts in mixt with an equal amt of Pyrocellulose (Vol 1 of Encycl, p A452-R)

1905. The problem of producing quite satisfactory antifreeze remained unsolved until S. Nauckhoff of Sweden published his work in ZAngewChemie 18, pp 11 & 55 (1905), in which he formulated the requirements for a satisfactory antifreeze and gave a list of compds which might prove to be suitable

1906. **Centralites** were first investigated in Germany at the Zentralstelle für wissenschaftlich-technische Untersuchungen zu Neubabelsberg (Central Laboratory for Scientific & Technical Research at Neubabelsberg) as possible stabilizers for smokeless proplnts. Several formulations were developed which proved to be very successful. A detailed description is given in Vol 2 of Encycl, pp C126 to C140

1906. Accdg to Gorst (Ref 71, pp 15-16, it was proposed in Russia to use LA (Lead Azide) in lieu of MF (Mercuric Fulminate) in compound detonators with Tetryl and later with **Ten** (PETN). Much work on improvement of LA detonators was done by Col A.A. Solonina. He also worked on detonators contg Lead Trinitroresorcinate, called in the US Lead Styphnate (LSt)

1906. After publication of Nauckhoff's paper (See under 1905), W. Will proposed TeNDG (Tetranitrodiglycerin) as an antifreeze, but it never was used in Germany. It was used in the US since 1912 (Vol 5, p D1589-R)

1906. Accdg to Tavernier (Ref 44, p 252), WASAG patented as **muzzle flash suppressors**, organic salts (such as tartrate, oxalate or citrate of sodium)

1906. Dr C. Claessen patented in Germany the use of totally substituted ureas as stabilizers in smokeless proplnts. These substances can be subdivided into derivs of sym-N,N'-diphenyl-

ureas and asym-N,N-diphenylureas. Some of them served as gelatinizers

sym-N,N'-Diphenylureas were investigated beginning in 1906 at the Central Laboratory for Scientific and Technical Research at Neubabelsberg, near Berlin and named **Centralites**. There were developed Nos 1, 2, 3, 4 and Butyl Centralites, all good stabilizers for NC's, especially No 1. More detailed description is given in Vol 2 of Encycl, pp C126-R to C140-R

asym-N,N-Diphenylureas, known now as **Acardites** were described before WWI by J.P. Reudler in Rec 33, 49-55 (1914). We were able to describe them in detail because Dr Hans Walter, who worked with them during WWII in Germany, gave us some info which is not in the literature (See Vol 1 of Encycl, pp A7-R to A9-L). Especially useful was Drs H & B Walter's help in description of Analytical Procedures (See Vol 1, pp A9-L to A10-R). P. Tavernier described Acardites in MP 38, pp 307-08 & 329 (1956)

1906. Hexanitrozobenzene prep'd by E. Grandmougin & H. Lehmann and recommended by T.L. Davis for use in boosters (Vol 1 of Encycl, pp A649-A650)

1906. Adoption by French Navy for large caliber cannons of poudre B Marine with 8% amyl alcohol as stabilizer (poudre BAm₈) in lieu of previously used BAm₂. (Ref 44, p 249)

1907. Adoption in 1906 by the French Navy of proplnt with 8% amyl alcohol stabilizer did not prevent the disastrous expln in 1907 of battleship Iéna. As a result of this, previously tested DPhA (diphenylamine) was approved as stabilizer of Naval cannon proplnt, which became known as "poudre B(Bo)" (Ref 44, p 249) (See also Vol 1 of Encycl, p A395-L)

1907. Vezio Vender of Italy patented as an antifreeze for Dynamites, mixed glycerol esters, such as Dinitroacetin with Dinitroformin [Ref: SS 2, 21 & 195 (1907)]

1909. Ammonium Picrate (AmmPicr), Dunnite or **Explosive D**, was standardized in the US as a bursting charge for AP (Armor-Piercing) shells (Ref 64, p 2-3). Its prep'n and properties are described in Ref 70, pp 136-39, where it is stated that AmmPicr was first prep'd in 1841 by Marchand and in 1869 used by Brugère in admixture with K nitrate as a proplnt. Used as an HE after 1900 (See also 1841)

1909. Accdg to Colver (Ref 12, p 18), low-nitrated aromatic hydrocarbons, such as MN-Naphthalene, MNBz & MNT started to be used in coal mining expls based on AN. This was because of their stability and insensitivity to shock & to ignition

1909. Accdg to Gorst (Ref 71, p 12), Russia started to use Trotil (TNT) for loading shells

1909. Silvered Vessel Test, devised by Sir Robertson for detn of stability of Cordite, was described by F.L. Nathan in JSocChemInd 28, 443 (1909), and briefly described by Reilly (Ref 28a, p 81) and in Vol 1 of Encycl, p XXIV. It is also known as "Waltham Abbey Test"

1909. Accdg to P. Tavernier (Ref 44, p 252), one of the greatest German discoveries was Pulver ohne Lösung (POL), called in Fr Poudre sans dissolvant (psd) and in Engl Solventless Powder (or Propellant). Its discovery was attributed to Brunswig & Thieme, although many other scientists contributed to development of such proplnts

1910. B. Flürschein patented the prep'n of 2,3,4,6-Tetranitroaniline, one of the most powerful expls. It was used during WWI by the Germans and Japanese (Vol 1 of Encycl, pp A411 to A413)

1910. Beginning in Oct, DPhA became the only stabilizer used in French proplnts, but there were supplies contg amyl alcohol and one of the battleships, Liberté, had in 1911 a fire resulting in expln of poudre B(Am₈) of 1906 vintage. The ship was partially destroyed (Ref 44, p 249 & Ref 31a, p 308)

1910. Tetracene, described in Vol 6, p G169 as **Guanylnitrosaminoguanyl Tetracene** was first prep'd by K.A. Hofmann et al. The most extensive studies were done in 1931 by Rinkensbach & Burton

1910-1911 & 1913. Dr C. Claessen developed a procedure for prep'n of solventless proplnts contg about 30% NG. In his process the slightly wetted blend of NC-NG, known as galette (cake), with some additives was fed between two rolls (heated to 85-95° by hot water circulated in them) in order to obtain the mass in the form of a sheet. This is called "lamination". Then the sheet passed thru a press to be drawn in the desired form. In order to facilitate the prep'n of such proplnts,

some low N content NC was included in the cake or about 5% of $\text{NH}_4\text{-Na}$ oxalate was incorporated. Aromatic nitrocompds with mp's below 100° , such as DNT or TNT were also recommended. The 1st Ger solventless proplnt, RPC/12, contd 70% of blend of NC's, resulting in a N content of 11.7%, NG 25 and 5% of Centralite. It was made in large grains and, since it was solventless, the time consuming operation of solvent proplnts was not required. The proplnt was used in large caliber cannons (Ref 44, pp 252-53)

After 1911. As a result of disastrous explosions of battleships *Iéna* (1907) and *Liberté* (1911), it was decided to investigate various stabilizers besides DPhA, such as naphthalene, MNNaphthalene, carbazole and DPhNitrosamine. None of them proved to be better than DPhA (Ref 31a, p 309 & Ref 44, p 250)

1912. Carbonit AG patented the following expls: Hexanitrodiphenylamine, Hexanitrodiphenylsulfide, Hexanitrosulfobenzide, Hexanitrodiphenyloxide and Hexanitrodiphenyl (Ref 12, pp 25 & 26)

1912. Accdg to E.M. Symmes (translator of Naoúm's book), DGTen (Diglycerin Tetranitrate) introduced in 1906 by W. Will as an antifreeze was not used in Germany, but it was used in the USA to a very large extent until about 1926 (See footnote 5 on p 202 of Ref 16 and in Vol 5 of Encycl, under Diglycerol, p D1261-L)

1912. Modified British **Cordite MD** used in rifles, changed its form from cords to small tubes (Ref 44, p 253)

1912. TNT, first prepd in 1891 (qv) by G. Häussermann and adopted in 1902 by the Germans, in 1907 by the Italians and in 1909 by the Russians. It began in 1902 in the US to replace PA, and then in 1912 became the standard bursting charge for HE shell for the mobile artillery of the US Army (Ref 64, p 2-4 and Ref 70, pp 350-58)

1912. **Nitroisobutylglycerol Trinitrate** or **Trimethylolnitromethane Trinitrate** was first prepd by Hofwimmer. Used as expl gelatinizer for NC (Ref 70, pp 244 & 245)

1912 & 1914. Although **Nitroglycol (NGc)** or **Ethylene glycol Dinitrate (EGcDN)** was known since 1904, it was not properly described until before WWI [See MP 16, 73 (1912) and

17, 175 (1914)]. It proved to be the best antifreeze for Dynamites and was found to be suitable as a substitute for NG. Large quantities of NGc were used in Germany during WWI. As an antifreeze it was used in mixts of 20/80-NGc/NG (Vol 5 of Encycl, p D1590-L & R). Prepn and properties of EGcDN are described in Vol 6, pp E259-R to E278-L, under **ETHYLENEGLYCOL DINITRATE**

1912-1914. Russian proplnts were based on **Pyrocollodion** of Mendeleeff. They contd 1% of DPhA stabilizer and were in the form of tubes

US proplnts were based on **Pyrocellulose** introduced by Lt Bernadou. They contd 1% of DPhA and were usually multitubular in form

Italian proplnt, manufd from 1896 at the Royal Powder Factory at Liri was **Solenite**, which was similar to Brit Cordite contg about 35% of NG. It consisted of 1/3 Guncotton, 1/3 Collodion Cotton and 1/3 NG with added vaseline (replaced later by Centralite). Beginning in 1910, the Société Nobel of Avignona manufd **C₂**, which was a variety of Brit Cordites but in the form of tubes. Italians manufd also **Ballistite** of high NG content which contd 0.5% of aniline as stabilizer (Ref 44, p 253)

1913. Compression (or Crusher) Test of Kast is described in Vol 3 of Encycl, p C493

1913. A.S. Flexer of Vienna patented a process for manuf of nitrocompds from petroleum and tar but they found no practical application at that time (Ref 12, pp 27-28)

1913. Westfälisch-Anhaltische Sprengstoff AG (WASAG) devised solventless proplnts with low NG content in which stabilizers-plasticizers were anilides of org acids in which hydrogen of imide group was replaced by a radical: ethyl or methyl acetanilide. The same Society proposed using esters of carbonic acid in which two hydrogens were replaced by radicals, such as diphenylurethane or methylphenylurethane. This permitted reducing the temp of lamination to 82° (Ref 44, pp 251-52)

1914. Lead Styphnate (LSt) or Trinitroresorcinol was first prepd by E. von Herz (Ref 70, pp 193-96)

1914. G. Spica of Italy proposed using phenanthrene as stabilizer in solventless proplnts

with low NG content (Ref 44, p 254)

1914. Cordite SC, Solventless was developed at Waltham Abbey, England (Vol 3 of Encycl, p C532-R)

1914. Trotyl (TNT) started to replace in France Mélinite (PA) as bursting charge

1914–1918. World War I. Prior and during the War many explosives, serving as substitutes or supplements of TNT, were developed in Germany, Austria, Russia, Italy and Great Britain. The most important were mixtures of HE'S (such as TNT, TNX, TNN and others) with AN and Al were: **Amatols** (British) (TNT with AN in various propns) (Vol 1 of Encycl, pp A158 to A164); **Ammonals** (Austrian & US) (TNT or other HE with AN & Al) (Vol 1 of Encycl, pp A287 to A292) and **Alumatol** (British) consisting of AN 77, TNT 20 & Al 3%, used for filling bombs and trench mortar shells (Vol 1, pp A141-R & A142-L). In Russia Col A.A. Solonina proposed using mixt of Trinitro-m-xylene (Ksilil, in Rus) with AN & Al for loading hand grenades (Ref 71, p 14)

WWI. Incendiary bombs developed at that period were not very effective and comparatively easy to extinguish (Vol 2, p B243-R)

1915, April 22. Modern Chemical Warfare began with the German attack at Ypres, France, when 5700 barrels of chlorine gas were released against French and Canadian trenches. The attack was most effective because it was unexpected and many casualties resulted. This "gas-cloud method" was soon replaced by "chemical shells" which were widely used during WWI. Although "chemical warfare" was outlawed after WWI by the Hague Convention, all great nations continued development of new agents. The most efficient was Germany who developed before WWII several "nerve gases", such as **Trilons** described in PATR 2510 (1958), p Ger 204-L and in Vol 2 of Encycl as **GA & GB** on p C167-R. They are also described in Vol 5, pp D1308-R to D1309-L, under Dimethylaminocyanophosphoric Acid, Monomethyl Ether. A comprehensive list of chemical warfare agents developed during WWI & WWII by various countries is given in Vol 2 of Encycl, pp C166 to C173, under "Chemical Warfare Agents"

A brief description of the use of poisonous and smoke gases in ancient times is given in

this section under the years **431–404BC**

1915. Dr C. Claessen patented in Germany a smokeless propnt with volatile solvent, stabilized by introducing a large quantity of eutectic mixt DNT–TNT (Ref 44, p 251)

1915. Amatols (TNT+AN) were developed by the British in order to extend the available supply of TNT which was scarce (Vol 1 of Encycl, p A158)

1916. Dr C. Claessen patented solventless NC–NG propnt contg alcyaryl- or diaryl-cyanamides as stabilizers (Ref 44, p 251)

1916. Ballistite 50/50, invented by Nobel, was manufd as propnt for mortars. It was partially replaced by Attenuated Ballistite, which contd 25% NG and 15% DNT. The German name, **Würfelpulver (WP)**, was assigned to Ballistite 50/50 used in mortars (Ref 44, p 252)

1916–1917. Single base NC propnts were used in rifles and in the shape of tubes in some cannons. As gelatinizer for such propnt an ether-alc mixture was often used, and as stabilizer diphenylamine (DPhA). Some NC–NG propnts, gelatinized by acetone, contd small amts of organic nitrates. As stabilizer they used DPhA and later Centralite or Acardite. They were surface-treated by Centralite or by aromatic nitrocompds. Such NC–NG propnts were used in large caliber cannons (Ref 44, p 252)

1917. Austrian Ammonal T was developed by R. Förg to be used in underwater expls, such as torpedoes and depth charges. It consisted of AN, Al & TNT (Vol 1 of Encycl, p A291-L & table on p A290)

1917. Accdg to Tavernier (Ref 44, p 252), WASAG patented as **muzzle flash suppressor** K chloride (0.5 to 5g)

1917. Ardeer Cordite was introduced (Vol 3 of Encycl, p C532-R)

After WWI. Metriol Trinitrate or Trimethylol-methane Trinitrate was prepd in Italy and in 1927 in Germany. Used as an ingredient of rocket propnts (Ref 70, pp 206–08). Its prepn and uses in Germany during WWII are described in PATR 2510 (1958), p Ger 113

1920. Accdg to Davis (Ref 31a, pp 311–13), transformation of DPhA during aging was conducted beginning in 1920 by Desmaroux, Marqueyrol & Muraour and Marqueyrol & Loriette; also by Davis & Ashdown (See also

Vol 5 of Encycl, pp D1417-R to D1418-L)
1920. **Cardox** is a device for breaking coal in gaseous mines by the pressure produced on heating liquefied carbon dioxide. It is briefly described in Vol 2 of Encycl, p C67-R. Similar devices, **Airdox** and **Armstrong Air Breaker**, were developed in 1930 in the US. More successful were **Hydrox** developed in 1955 and **Chemecol** developed by du Pont Co before 1958. They are also **Hydraulic Coal Bursters** (See Vol 3 of Encycl, p C434)

1921. It was known that some stabilizers act also as *gelatinizers* or *colloiding agents*

Davis (Ref 31a, pp 320-22), under the title "Gelatinizing Agents", describes results of investigation in France beginning in 1921 by **Marqueyrol & Florentin** of a number of esters, amides, urea derivatives, halogen compds, ketones and alcohols as possible gelatinizers of soluble and insoluble NC. In 1922, Davis investigated many compds and gave in his book on p 322, a Table listing parts by wt required for complete gelatinization of **Pyrocellulose** (See also Vol 3 of Encycl, p C398-L, under the title "Colloiding Agents")

1923. O. Turek prepd **1,3,5-Triazido-2,4,6-trinitrobenzene** and described its prepn and properties in *Chim&Ind(Paris)* **26**, 781 (1931) (See Vol 2 of Encycl, pp B43 & B44)

1923. W. Borsche, *Ber* **56B**, 1942, described **1,3,4,5- & 1,2,4,5-Tetranitrobenzenes**, both of them very expl (See also Vol 2 of Encycl, p B50 and Ref 70, pp 378-80)

1925. R.C. Moran prepd **2-(2',4',6'-Trinitro-N-nitranilino)-Ethanol Nitrate**, also known as **Pentryl**. Not to be confused with **Pentryl** of A. Stettbacher, which designates mixts of **PETN** & **TNT** known in the US as **Pentolites** (See Vol 1 of Encycl, pp A425-29 and Ref 31a, p 229)

1927. Continuous Methods of Manufacture of Explosives. The first successful method was invented by **Schmid** of Austria, but some attempts were made as early as 1864. Description, with flow sheets is given in Vol 3 of Encycl, pp C501 to C510 for the methods of **Schmid**, **Biazzi**, **German** and **Bofors**

1927. Diethyleneglycol Dintrate was thoroughly examined by **W.H. Rinkenbach** and its current method of prepn was patented in 1928 by **A. Hough**. A detailed description is given in the book of **T. Urbański**, Vol 2, pp 149-54

(1965) and a briefer description in Vol 5 of Encycl, pp D1232 & D1233-L (See also Ref 49, p 168)

1927. Trimethyleneglycol was first described by **A. Rayner**, but it was mentioned in 1895 by **Noyes & Watkins** as occurring in some glycerols (Ref 49, pp 206 & 209)

1928. **B. Fliirschein & E. Holms** prepd **2,3,4,5,6-Pentanitroaniline** in the pure state and found it to be a most powerful expl, comparable to **RDX** & **PETN**. It was stable while the same expl prepd in 1910 in impure state was unstable (Vol 1 of Encycl, p A414)

1928. Nitraminoguanidine and Its Salts were prepd by **R. Phillips & J.W. Williams** (Vol 1 of Encycl, pp A210-R to A212-L and A213-R)

1929. PVN (Polyvinyl Nitrate) was first prepd in Germany and patented in 1938 in the US. Its uses are not indicated (Ref 70, pp 315-17)

1929. **Accdgt Dutton** (Ref 58, p 174), the first cyclotron was built in the USA

1929. Copper Chlorotetrazole first prepd by **R. Stollé et al.** More recently (1955), it was prepd and investigated at **PicArns** as possible ingredient of primary compns (Ref 70, pp 63 to 65)

1930. Dipentaerythritol Hexanitrate (DPEHN), obt'd as impurity in **PETN** by **W. Friederich & W. Brün** was also prepd in 1945 at **PicArns** by **S. Livingston** and at **Hercules Powder Co Lab** at **Radford, Va** (Ref 70, pp 119-21 and Vol 5 of Encycl, p D1413)

1930-1931. Lead Azide, Dextrinated started to be used in the US, replacing gradually **MF (Mercuric Fulminate)** in priming compns (Vol 1 of Encycl, pp A545-R and A552-L). Plain, impure **LA** was first prepd in 1891 by **T. Curtius**, but it was not until 1907 when **T. Heronius** of France succeeded in using it in explosives industry. It started to be used in 1920 in Europe, but in the US only dextrinated **LA** was allowed beginning 1930-31 (Ref 70, p 185)

1931. Propyieneglycol, although first prepd in 1859 by **Ch.A. Wurtz**, it was not used until 1931 when it was produced on commercial scale by **Carbide & Carbon Co** (Ref 49, p 203)

1931. Glycerol Monolactate Trinitrate, patented in the US by **Ch. Stine & Ch. Burke**, was investigated in 1946 at **PicArns** as possible expl plasticizer for **NC** (Ref 70, pp 140-42)

1931. 2,4-Dinitrotoluene (2,4-DNT) obt'd

Problem
 in
 12/12

earlier as an impurity in crude TNT, was used in some expl mixtures (Ref 70, pp 116-18)

1933. Anilinotetrazole and its Derivatives were first prepd by R. Stollé et al (Vol 1 of Encycl, p A437-R)

1933. Pentritnit is a mixture of 20-50% of PETN with 80-50% NG. It was developed by A. Stettbacher (Ref 41, pp 83-4)

1933. Hexonit is a mixt of 20-50% RDX with 80-20% NG. It was developed by A. Stettbacher (Ref 46, p 111)

1934. Lead-2,4-dinitroresorcinate was prepd and examined at PicArns by J.D. Hopper and later (1944) by K.S. Warren (Ref 70, pp 187-89)

1934-1935. "G" Pulver. This proplnt was developed in Germany under the direction of Gen Uto Gallwitz. It was a "cool" double-base proplnt in which NG was replaced by DEGcDN or TEGcDN (Vol 3 of Encycl, p C400-R and pp C511 & C512)

1935. Ball Powder was developed by Fred Olsen of Olin Mathieson Chemical Corp (Vol 2 of Encycl, pp B11-B16)

1935. Accdgd to Dutton (Ref 58, p 143), the World's largest Dynamite Plant was constructed near Modderfontein, South Africa. It was operated by the African Explosive and Chemical Industries

1936. Pentaerythritol Trinitrate or PETRIN. Nitration products of PETN contg not more than 3-NO₂ groups were patented in Germany in 1936, but pure PETRIN was not prepd until 1954 (Ref 70, pp 265-68)

1937. Baratol, which is the mixture of Ba nitrate and TNT (Tol), was developed by the British and used during WWII (Vol 2 of Encycl, pp B18 & B19)

1937. Gudolpulver was a "cool" proplnt developed in Germany by Dynamit AG Plant. It consisted of NC, DEGcDN & NGu (Nitroguanidine) (Vol 3 of Encycl, p C401-L)

1939. This year may be considered as the beginning of work on development in the US of atomic (or nuclear) energy. This work is briefly described by C.G. Dunkle in Vol 1 of Encycl, pp A500ff

1940. Composite Propellants consist of finely ground oxidizer (such as inorg perchlorate or nitrate) in a matrix of a resinous or elastomeric material which serves as a fuel. The proplnts

for use in JATOS were developed beginning 1940 (Vol 3 of Encycl, pp C464-C474)

1941. R.C. Elderfield prepd N-(2,4,6-Trinitro-N-nitranilino)-Trimethylolmethane Trinitrate, designated as **Heptryl**, and called by G.B. Kistiakowsky N-Nitro-N-picryl-trimethylolmethylamine Trinitrate. It proved to be HE comparable in power and sensitivity to PETN (Vol 1 of Encycl, pp A441-R & A442-L)

1941. Lead Nitraminoguanidine was prepd and examined at Picatinny Arsenal by A.J. Phillips. It was later recommended by L.R.V. Clark for use in primers and detonators (Vol 1 of Encycl, pp A212-R & A213)

Prior to WWII. Cartridge-Actuated Devices (CAD's) or Propellant Actuated Devices. The first successful devices for pilot's quick escape from a plane were developed by the Germans. They called them "Schleudersitzpatronen" and equipped them in many of their fighter planes. The British equipped their planes having speeds greater than 400mph with such devices beginning in 1945. The Americans started the study of emergency escape as early as 1940, but it was not until 1947 that the first device was standardized. It was named "MI Personnel Catapult" (Vol 2 of Encycl, pp C70 to C72)

Prior to WWII. Composition B or Cyclotol, developed by the British, consisted of a mixture of RDX with TNT in various proportions. Some mixts contd wax. Its modifications as standardized during WWII in the US were: **Compositions B-2; B-3; B-4 and B. Desensitized** (Vol 3 of Encycl, pp C477-R to C484-L) (Ref 70, pp 46-50)

Prior to WWII. Under Dimethylaminocyanophosphoric Acid, Monomethyl Ester are described in Vol 5 of Encycl, pp D1308-R to D1309-R German Nerve Gases, such as **Sarin, Tabun, Trilon and Soman.** They are also described in PATR 2510 (1958), p Ger 204-L, under Trilons

Prior to WWII. Cyclotols, which are mixtures of Cyclonite (RDX) with TNT in various proportions were developed by the British and standardized in the US (Ref 70, pp 76-85) and Vol 3 of Encycl, pp C477-R to C484-L under Composition B Type Explosives and Cyclotols)

Prior to WWII were developed in Switzerland and Germany extremely toxic nerve gases, described under **Trilons** in Ref 56, p Ger 204-L
WWII. Items Developed or Standardized During

WWII. Ethylenedinitramine, EDNA or Haleite, first prep'd in 1887 by Franchimont & Klobbie and developed in 1935 as a military explosive by G.C. Hale, was standardized during WWII as a component of **EDNATOL** (EDNA+TNT) serving as bursting charge for bombs and shells (Ref 70, pp 131-R and 154). See also Vol 6 of Encycl, pp E238ff

WWII. EDNATOL (EDNA 55 & TNT 45%). See previous item and Ref 64, pp 7-74 & 7-75 and Ref 70, pp 130-32)

WWII. Cyclotetramethylene Tetranitramine or Homocyclonite (Code named **HMX**, which means "High Melting Explosive), was prep'd in 1943 by W.E. Bachmann (OSRD Rept 1981) and investigated at PicArns by S. Livingston and O.E. Sheffield, et al (Ref 64, pp 7-64 to 7-66 and Ref 70, pp 173-77)

V-1 (Buzz Bomb) is described in Ref 56, p Ger 213-L

V-2 (Rocket) is described in Ref 56, p Ger 213-R

WWII. Pentolites, of which 50/50-PETN/TNT mixture is the most important, was standardized for use in shaped charges, bursting charges and demolition blocks (Ref 64, pp 7-69 to 7-71 and Ref 70, pp 272-75)

WWII. Tetrytols, of which 70/30-Tetryl/TNT, castable mixture is the most important in military applications. It was standardized for use in burster type of chemical shells and in demolition blocks (Ref 64, p 7-72 and Ref 70, pp 341-49)

WWII. Picratol (PA 52 & TNT 48%) was developed as insensitive, castable filler for AP bombs and shells (Ref 64, pp 7-72 to 7-74 and Ref 70, pp 285 to 287)

WWII. Torpex (RDX 42, TNT 40 & Al 18%) developed by the British for use as a filler of warheads, mines and torpedoes (Ref 64, pp 7-77 & 7-78 and Ref 70, pp 259 to 263)

WWII. HBX-1 (High Blast Explosive-1) is a modification of Torpex. Its compn & props are given on p 7-79 of Ref 64 and in this Vol of Encycl (See also Ref 70, pp 156 to 158)

WWII. Demolition Explosives and Cratering Charge are described in Vol 3 of Encycl, pp D54 to D61. See also Ref 64, pp 7-84 & 7-85

WWII. Military Dynamites are described in Ref 64 p 7-84

WWII. DBX (Depth Bomb Explosive) is an

Amer expl developed to replace the Brit more sensitive Torpex (Vol 3 of Encycl, p D19-L and Ref 70, pp 91 to 94)

WWII. Lead-4,6-dinitroresorcinol, Basic was prep'd by the British for use in electric detonators (Ref 70, pp 190 to 192)

WWII. Nipolits are types of NC-DEGDN-PETN propellants or expls patented by Dr E. von Holt, the inventor of **Holtex** (See under year 1958). Compns and some props of Nipolits are listed in **PATR 2510** (1958), p Ger 117

WWII. Bombs, Incendiary were very efficient and hard to extinguish. They did more damage to the buildings than did other bombs. A brief description of such bombs and the damage inflicted by them during WWII is given in Vol 2 of Encycl, pp B235 to B237

WWII. Composition A, developed by the British, consisted of RDX 91 & beeswax 9%. When standardized in US, beeswax was replaced by synthetic wax and the expl became Composition A-2. Other modifications were Compositions A-3; A-4 and A-5 (Vol 3 of Encycl, pp C474 to C477)

WWII. Composition C, developed by the British, was a plastic RDX demolition expl. As standardized in the US, it consisted of RDX 88.3 & a nonexplosive plasticizer 11.7%. Its other modifications were **Comp C-2, C-3 and C-4**. The C-4, known as **Harrisite**, was developed before 1950 by K.G. Ottoson at Picatinny Arsenal. Their compns are given in Vol 3 of Encycl, pp C484 to C488

WWII. Azon Guided Missile, developed during the War, is briefly described in Vol 1 of Encycl, p A662-R

WWII. Bangalore Torpedoes were developed and are described in Vol 2 of Encycl, pp B16-B18

WWII. Baronal, consisting of Ba nitrate, TNT & Al, was described in 1942 in OSRD Rept 1035 (Vol 2 of Encycl, pp B21 & B22)

WWII. Cast Double-Base Propellants for Rockets, developed at the beginning of 1944 are described in Vol 2 of Encycl, pp C84 to C86

WWII. Flashless Cordite contg NGu (Nitroguanidine) was adopted as the best, after investigation beginning in 1921, of various additives to Cordites (Vol 3 of Encycl, p C533 and Ref 30, p C536-L)

WWII. Cyclotetramethylenetetranitramine, called **HMX** by the British and also known as **Octogen** was described in OSRD Rept 652 (1942) and in Vol 3 of Encycl, pp C605-R to C610

WWII. RDX or Cyclonite. See 1899. Cyclo-trimethylenetrinitramine

WWII. Demolition Explosives. Wide use was made in demolition practice of **shaped charges**, which utilize the Munroe-Neumann Effect, described in Vol 4 of Encycl, pp D442 to D443. US demolition shaped charges are described in Vol 3 of Encycl, p D58, while US plain demolition charges are on p D57. British, French, German, Japanese and Russian charges are on pp D58 to D60

WWII. Depth Charges are described in Vol 3, pp D86 & D87

WWII. Destructors are described in Vol 3, pp D92 to D96

WWII. Detonating Cords or Detonating Fuses are briefly described in Vol 3, pp D103 to D106 (See also 1902. Cordeau détonant)

WWII. Shaped Charge Effect, discovered in 1888 by C.E. Munro and applied in 1910 to manuf of expl items by E. Neumann, was extensively utilized during the war. The effect is described under Detonation, Munroe-Neumann Effect in Vol 4 of Encycl, pp D442 to D454

WWII. Triethyleneglycol Dinitrate was prepd in Italy and then in Germany for use in "cool" double-base proplnts, "G" Pulvern, of Gen. U. Gallwitz intended for hot climates like N. Africa. It was also used as proplnt in the "Nebelwerfer" (Ref 49, p 176 & Ref 70, pp 368--69)

WWII. H-6 is a HE consisting of RDX 45, TNT 30, Al 20 & D2 Wax 5% with 0.5% Ca chloride added (Ref 70, pp 146 to 148) (See also in this Vol of Encycl, p H1-L)

WWII. HMX (High Melting Explosive) is listed as Cyclo-trimethylene Tetranitramine

WWII. Minol-2, Brit expl contg TNT 40, AN 40 & Al 20% developed for use in depth bombs (Ref 70, pp 209 to 212)

WWII. Trimonite. A castable mixt of PA 88-90 & MNNaphthalene 12-10% developed by the British as an improvement over **Tridite** (PA 80 & DNPhenol 20%). Used as TNT substitute in bombs and shells (Ref 70, pp 370 to 372)

WWII. PIPE is a mixture of PETN 81 and Gulf Crown E Oil (Ref 70, pp 294 to 295)

WWII. PTX-1 (Picatinny Ternary Explosive) is a eutectic mixt of RDX 30, Tetryl 50 & TNT 20%. It was developed in 1943 at PicArns and used in land mines and demolition charges (Ref 70, pp 306 to 308)

WWII. PTX-2 consisted of RDX 44-41, PETN 28-26 & TNT 28-33%, developed in 1943 at PicArns and used in shaped charges (Ref 70, pp 309 to 311)

WWII. PVA-4 (Polyvinyl Acetate-4) is a semi-plastic expl contg RDX 90, polyvinyl acetate 8 & DBuPh 2%. It was developed in Canada and used in demolition charges. (Ref 70, pp 312 to 315)

WWII. RIPE. Mixture of RDX 85 & Gulf Crown E Oil 15%; developed in the US as a plastic demolition expl (Ref 70, pp 318-19)

WWII. Hybrid Rocket Propellants are described in this Vol

WWII. PH-Salz (Ethylenediamine Dinitrate) was used by the GERMans in mixts with AN and other ingredients for filling some shells (Ref 56, p Ger 131)

1945. This year there were completed the first three atomic (or nuclear) bombs. The first bomb was successfully exploded in the New Mexico desert on July 16, 1945, and a second over Hiroshima, Japan on Aug 6, 1945, and the third over Nagasaki on Aug 9, 1945. The bombs were of **Fission Type** and of tens of kilotons (thousands of tons of TNT equivalent) (Vol 1 of Encycl, p A499-L)

1945. PLX (Picatinny Liquid Explosive) consisting of Nitromethane 95 & Ethylenedinitramine 5% was developed at PicArns by L.H. Eriksen & J.W. Rowen for use in minefield clearing (Ref 70, pp 298 to 301)

Note: Germans used during WWII similar liquid expls under the name of **Myrol**, which are described in PATR 2510 (1958), pp Ger 115 & Ger 116

1945. Tripentaerythritol Octanitrate was patented by J.A. Wyler of Trojan Powder Co, Allentown, Penna. It was used as an HE and as possible gelatinizer for NC (Ref 70, pp 382 to 384)

After WWII. Composition D-2 which is not an expl, but serves as an emulsifier and desensitizer of expls like HBX-1, consists of wax 84, lecithin 2 & NC 14% (Vol 3 of Encycl, p C488-R)

Compositions EL-387A and EL-387B, de-

veloped by the duPont Co, were slurry expls of compns given in Vol 3 of Encycl, pp C488-R & C489-L

1948. The first **Fusion Type Atomic Bomb** (also known as **Hydrogen Bomb**, **H-Bomb** or **Thermonuclear Bomb**) was tested at Eniwetock and proved to be successful. The bomb was of several megatons (millions of tons of TNT equivalent) (Vol 1 of Encycl, p A499-L & R)

1950. **MOX** (Metal Oxidizer Explosives) were developed by National Northern, technical division of the National Fireworks Ordnance Corp, West Hanover, Massachusetts, for use mostly in small caliber anti-aircraft shells. Their compns and props are described in Ref 70, pp 213 to 225

1950. **Trinitroethyl Trinitrobutyrate** seems to have been first prepd at NavOrdLab and then at Hercules and US Rubber Labs. It is a high oxygen content expl (Ref 70, pp 375 to 377)

1951. **Ethylene glycol Di(trinitrobutyrate)** was prepd at the US Rubber Co Lab, Passaic, New Jersey (Ref 70, pp 133 to 135)

1952. **Dynamite, Medium Velocity, Military** was developed by W.R. Baldwin, Jr at Hercules Powder Co Lab (Ref 70, pp 125 to 127)

1952. **2,2-Dinitropropyl-4,4,4-trinitrobutyrate** was prepd by M.E. Hill at NavOrdLab (Ref 70, pp 113 to 115)

1952. **Bis-(2,2-Dinitropropyl)-fumarate** was prepd by M.E. Hill at NavOrdLab and in 1954 by D.L. Kouba & H.D. McNeil of Hercules Powder Co (Ref 70, pp 107 to 109)

1952. **PB-RDX** (Plastic-Bonded RDX) was developed by Los Alamos Scientific Laboratory of the University of California for use as a mechanical strength expl. It consisted of RDX 90, polystyrene 8.5 & dioctylphthalate 1.5% (Ref 70, pp 259 to 264)

1953. **Bis-(2,2-Dinitropropyl)-succinate** was prepd by M.E. Hill of NavOrdLab (Ref 70, pp 110 to 112)

1953. **HEX** (High Energy Explosives) developed at PicArns are described in Ref 70, pp 164 to 169 and in this Vol, p H73-L

1956. **Pentaerythritol Tetranitroacrylate or PETRIN Acrylate** was developed by Rohm and Haas Co, Redstone Arsenal Division (Ref 70, pp 269 to 271)

1957. **Dynamite, Low Velocity, Military** was developed at PicArns by H.W. Voigt (Ref 70, pp 122 to 124)

1957. **Veltex** is the name given to a series of closely related NC compns prepd in 1957 at PicArns by the solventless process. They all contain a high percentage of solid HE. Hispano-Suiza Co investigated them to determine their suitability as **Holtex** type expls (See year 1958). **Veltex** expls are proposed for use as high mechanical strength machinable expls. Compn of **Veltex** No 448 is: NC (13.15% N) 15.0, HMX 70.0, NG 10.7, 2-NitroDPhA 1.3 & Triacetin 3.0% (Ref 70, pp 391 to 394)

1958. **MASER and LASER.** Accdg to "Time" magazine of July 12, 1968, pp 42-9, physicists A. Schawlow & C. Townes described in 1958 a device which was a variation of Townes earlier Nobel prizewinning invention named **MASER**. The first working model of this device was built in 1960 by physicist Maiman, who named it **RUBY LASER**. A brief description of these and later developed devices is given in Vol 4 of Encycl, pp D436 to D440, compiled by C.G. Dunkle, formerly of Picatinny Arsenal

1958. **HTA-3** (High Temperature Explosive), consting of RDX 49, TNT 29 & Al 22%, was prepd at PicArns by R. Brown & R. Velicky (Ref 70, pp 178 to 181). See also in this Vol **1958. Octols 70/30 and 75/25** are mixts of HMX and TNT developed at Northern Corp as fillers for bombs and shells (Ref 70, pp 249 to 258)

1958. **Holtex** was patented by Dr E. von Holt of Hispano-Suiza Co, who died in 1962 in an automobile accident. **Holtex** has several formulations which are listed in Vol 3 of Encycl, pp C396-L to C397-L

Ref: Dr H. Freiwald of Saint Louis Laboratory, Germany; private communication, 12 Sept 1962
Note: See also in Vol 3 of Encycl, pp C396-L ff
1960. **Detacord Process or Explosive Cladding**, also called **Explosive Bonding** was developed by the duPont Co (See Vol 3 of Encycl, pp D96 & D97)

1960. **Detacord, Detaflex Flexible Cord Explosive and Detasheet Flexible Cord Explosives** were developed by the duPont Co (See Vol 3 of Encycl, pp D97 to D101)

1967. Accdg to Nambo (Ref 66, p 39), the mining BkPdr of Nippon Kayaku Co, Ltd contd: saltpeter 64, sulfur 18 & charcoal 18%, while its sporting BkPdr contd: saltpeter 75.0, sulfur 12.5 & charcoal 12.5%

1972. Accdg to Gorst (Ref 71, p 173), the

Finished to here
12/18/56

average compn of Russian Black Powder (called "Dymny Porokh", which means Smoke Powder) is saltpeter (mostly of K) 75, sulfur 10 & charcoal 15%

Refs for History of Explosives and Related Items:

- 1) M. Jähns, "Handbuch einer Geschichte des Kriegswesen von der Urzeit bis zur Renaissance", Leipzig (1880)
- 2) W.W. Greener, "The Gun and Its Development", Cassell, Petter & Co, 1st Edn, London (1881); 9th edn (1910) (See Ref 7)
- 2a) S.G. Romocki, "Geschichte der Explosivstoffe", Berlin & Hanover, Vol 1 (1895) & Vol 2 (1896)
- 2b) Lt J.B. Bernadou, "Smokeless Powder, Nitrocellulose and Theory of Cellulose Molecules", J. Wiley, NY (1901) and 2nd Edn (1917)
- 3) J. Daniel, "Dictionnaire des Matières Explosives", Dunod, Paris (1902) (A brief history of explosives is given by M. Berthelot in "Préface", pp I to X, incl)
- 4) Col H.W.L. Hime, "Gunpowder and Ammunition", Longmans, Green & Co, London (1904)
- 5) Sir Andrew Noble, "Artillery and Explosives", Dutton Co, NY (1906)
- 6) R. Escales, "Schwarzpulver und Sprengsalpeter", Veil & Co, Leipzig (1910)
- 7) W.W. Greener, "The Gun and Its Development", Bonanza Books, NY, 9th Edn (1910), Chap I, "Early Arms"; Chap II, "The Invention of Gunpowder"; Chap III, "Early Artillery"; Chap IV, "Early Hand Fire-Arms"; and Chap V, "The Percussion System" (The book is available from Publishers Central Bureau, 33-20 Hunters Point Ave, Long Island City, NY 11101)
- 8) P.F. Chalon, "Explosifs Modernes", Ch. Béranger, Paris (1911), 228
- 9) G.W. MacDonald, "Historical Papers on Modern Explosives", Whittaker, London (1912)
- 10) Col H.W.L. Hime, "The Origin of Artillery", Longmans, Green & Co, London & NY (1915), pp 120, 127 & 231
- 11) Marshall 1 (1917), 11-22 (Early History), 12-34 (Development of Gunpowder); 35-50 (Progress of Explosives in the Eighteenth and Nineteenth Centuries)
- 12) Capt E. de W.S. Colver, "High Explosives", Van Nostrand Co, NY (1918), pp 1-29 (History of High Explosives); 496-501 (History of HE Projectiles); 501-05 (History of Shell Fuzes); 563-64 (History of Fuses)
- 13) Anon, "History of Trench Warfare Materiel", Army Ordnance Pamphlet (1920) (Available at PicArnsn Museum)
- 14) A.P. Van Gelder & H. Schlatter, "History of the Explosives Industry in America", Columbia Univ Press, NY (1927), pp 3ff (History of BkPdr in the USA)
- 15) P. Charbonnier, *MémArtilFran* 7, 1227 (1927) (Artillery)
- 16) Ph. Naoúm, "Nitroglycerine and Nitroglycerine Explosives" (Translated from Ger by E.M. Symmes), The Williams & Wilkins Co, Baltimore (1928), pp 1 to 22 (Discovery and Historical Review)
- 16a) H. Desvergnés, *ArmyOrdn* 10, 191-94 (1929) (History of development of military powders)
- 17) L. Vennin, E. Burlot & H. Lecorché, "Les Poudres et Explosifs", Ch. Béranger, Paris (1932) (No history is described)
- 18) P. Charbonnier, *MémArtilFran* 11, 1^{er}, 2^{ème}, 3^{ème} & 4^{ème} Fascicules (1932) (Artillery)
- 19) E. McFarland, "Textbook of Ordnance and Gunnery", J. Wiley, NY (1932)
- 20) Marshall 3 (1932), 1-2 (Early History); 3-5 (Development of Gunpowder); 6-8 (Progress of Explosives in the Eighteenth and Nineteenth Centuries)
- 21) A. Stettbacher, "Schliess- und Sprengstoffe", J.A. Barth, Leipzig (1933), pp 3-18 (Geschichtlicher Überblick)
- 22) T. Urbański, *MémArtilFran* 13, 825-42 (1934) (Le centenaire de la nitrocellulose)
- 23) G.C. Stone, "A glossary of Construction, Decoration and Use of Arms and Armor in All Countries and in All Times, Together With Some Closely Related Subjects", J. Brussel, NY (1934) (Over 3000 illustrations from the Stone Age to WWII - an exhaustive alphabetical listing and description of 10000 kinds of arms and armor thruout recorded history, in a 700pp volume) (Available from Publishers Central Bureau, Dept 353, 33-20 Hunters Point Ave, Long Island City, NY 11101)
- 24) A. Basset, *MémArtilFran* 13, 529-78 (1934) (Bibliography on Artillery; more than 1000 refs are listed)
- 25) A. Basset, *MémArtilFran* 14, 881-1280 (1935) (Essais sur l'histoire des fabrications d'armement en France)
- 26) J. Pepin Lehalleur, "Traité des Poudres, Explosifs et Artifices", Baillière, Paris (1935), 15-19 (Historique du développement de la pyrotechnie)

- 27) C. Beyling & K. Drekopf, "Sprengstoffe und Zündmittel", J. Springer, Berlin (1936), 1-5 (Geschichtliches)
- 28) T.J. Hayes, "Elements of Ordnance", J. Wiley, NY (1938) (No specific pages for history)
- 28a) J. Reilly, "Explosives, Matches and Fireworks", VanNostrand, NY (1938) (Describes various physical & expl tests)
- 29) V. Muthesius, "Zur Geschichte des Sprengstoffe und des Pulvers", Hoppenstedt, Berlin (1941) [Reviewed by Dr Hassenstein in SS 37, 111-12 (1942)]
- 30) E.E. Sancho, "Química de los Explosivos", A. Aguado, Madrid (1941), pp 263-61 (History of Black Powder and Ammunition & weapons using it)
- 31) M.M. Johnson, Jr & C.T. Haven, "Ammunition, Its History, Development and Use", W. Morrow, NY (1943)
- 31a) T.L. Davis, "The Chemistry of Powder and Explosives", J. Wiley, NY (1943)
- 32) M. Meyer, "Explosives", T.Y. Crowell Co, NY (1943), 1-4, 58, 118 & 155-56 (History)
- 33) J.R. Newman, "The Tools of War", Doubleday, Doran, NY (1943), pp 3-31 (Modern Warfare); 33-46 (History of Small Arms); 69-108 (History of Field Artillery); 109-175 (History of Fortification and Siegecraft); 176-203 (History of Tanks); 204-67 (History of Tools of Sea War); 268-363 (History of Tools of Air War)
- 34) Gen U. Gallwitz, "Die Geschützladung" (Cannon Charge), Heereswaffenamt, Berlin (1944) (Engl transl available at PicArns Library)
- 35) W. Hassenstein, SS 39, 1-9, 22-6 & 37-42 (1944) (The Chinese and the Discovery of Powder)
- 36) M. Vivas, R. Feigenspan & F. Ladreda, "Pólvoras y Explosivos Modernos", J. Morata, Madrid, Vol 1 (1945), pp 25-8 (Algo de historia)
- 37) A. Pérez Ara, "Tratado de Explosivos", Editorial "Cultural SA", LaHabana, Cuba (1945), 133-48 (Bosquejo histórico acerca de la pólvora ordinaria)
- 38) Maj T.C. Ohart, "Elements of Ammunition", J. Wiley, NY (1946) (No history of ammunition is given)
- 39) J. Weir, Nature 158, 83-85 (1946) Nitroglycerine and Guncotton (A Double Century) (Historical Review)
- 40) G.M. Barnes, "Weapons of World War II", VanNostrand, NY (1947)
- 41) A. Stettbacher, "Spreng- und Schiesstoffe", Rascher, Zürich (1948), 1-5 (Geschichtlicher Überblick)
- 42) A.D. Blinov, "Kurs Artillerii" (Artillery Course), Voenizdat, Moscow, Vols 1 to 12 (1948-1952) (Available in the Library of Congress)
- 43) Albert Manucy, "Artillery Through the Ages", US Govt Printing Ofc, Washington, DC (1949) (National Park Serv Series History No 3) (A short illustrated history of cannon)
- 44) Paul Tavernier, "Evolution Historique des Poudres Sans Fumée", MP 32, 239-53 (1950) & CA 47, 9014 (1953) (A Historic Development of Smokeless Powders) (The various stages are discussed that led to the discovery and formulation of smokeless powder. Accomplishments of various countries are given, with the more important dates up to the first World War)
- 45) LeRoux, RevIndustMinérale 33, 276-84 (1952) (History of development of expls industry)
- 46) A. Stettbacher, "Pólvoras y Explosivos", G. Gill SA, Buenos Aires (1952), pp 1-5 (Reseña historica)
- 47) W. Gutmann, Sprengtechnik 3/4, p 39 (1952) (Chronological list of some expls, proplts and ammunition manufd in Germany betw 1858 and 1937)
- 48) C. Belgrano, "Gli Esplosivi", Hoepli, Milano (1952) (History of explosives and related items is not found) [See 2nd edition (1974)]
- 49) G.O. Curme Jr & F. Johnston, "Glycols", Reinhold, NY (1952), pp 7, 74, 114, 119, 130, 148, 158, 168, 170, 176, 177, 203, 206 & 209
- 49a) E. Tunis, "Weapons. A Pictorial History", WorldPubgCo, Cleveland, Ohio (1954)
- 50) Gen J.F.C. Fuller, "A Military History of the Western World", Funk & Wagnalls Co, NY, Vol 1 (1954), pp 464 & 469-70 and Vol 2 (1955), p 12
- 51) B.T. Fedoroff et al, "Dictionary of Russian Ammunition and Weapons", PATR 2145 (1955); PB 159927, Available from NTIS
- 52) W.Y. Carman, "A History of Firearms", StMartin'sPress, NY (1955), 1-11 & 157-62
- 53) B.E. Schaar, "History of Accidental Scientific Discoveries", Schaar & Co, Chicago 7, Ill (1955) (Discoveries of Dynamite, acetylene, petroleum jelly, etc are described)
- 54) Anon, "Principles of Artillery Weapons", TM 9-3305-1 US Dept of Army, Washington,

DC (1956), 4-8 & 12-15

55) J. Pawle, "The Secret War 1933-1945", W. Sloane, NY (1957) (Story of the developments by the British Navy of some special weapons and devices)

56) B.T. Fedoroff et al, "Dictionary of Explosives, Ammunition and Weapons" (German Section), PATR 2510 (1958); ASTIA Document AD 160636, Available from NTIS (National Technical Information Service), US Dept of Commerce, Springfield, Virginia 22151; pp Ger I & Ger II (Historical uses of expls in Germany during WWI and WWII)

57) M. Giua et al, "Trattato di Chimica Industriale", UTET, Torino VI (1), 1959, 6-10 (Storia)

58) W.S. Dutton, "One Thousand Years of Explosives, from Wildfire to the H-Bomb", Winston, Philadelphia (1960), pp indicated under the years in text

59) R.E. Oakeshott, "The Archeology of Weapons, Arms and Armor from Prehistory to the Age of Chivalry", Illustrated by the Author, Prager, NY (1960)

60) J.R. Partington, "A History of Greek Fire and Gunpowder", Heffer, Cambridge, England (1960)

61) S. Fordham, "High Explosives and Propellants", Pergamon Press, London & NY (1966), 15-16 (Brief history of expls & propnlts)

62) Coll, "Blasters' Handbook", Published by E.I. duPont de Nemours & Co (Inc), Wilmington, Del (1966), pp 1-6 (Early History of Explosives); 7-20 (DuPont's Role Today) (See also Ref 68)

63) A.V.B. Norman & D. Pottinger, "A History of War and Weapons, 449 to 1660", Crowell Co, NY (1966), pp 13-224

64) Anon, "Military Explosives", Dept of the Army Technical Manual TM 9-1300-214, Nov 1967, pp 2-4 to 2-6 (Development of Military Explosives and Propellants)

65) W. Buehr, "Firearms", Crowell Co, NY (1967), pp 1-186

66) Dr Heizo Nambo of Nippon Kayaku Co, Ltd; "Who Invented the Explosives" Journal of the Industrial Explosives Society of Japan 28, 322-329 & 403-423 (1967). Japanese Studies in the History of Science No 9 (1970). English translation obtainable for \$15, surface mail, from Japan Publishers Trading Co, Ltd, PO Box 5030,

Tokyo International, Tokyo, Japan. The paper contains nearly 100 entries and 30 refs of which only 4 are Western. The entries are arranged in chronological order. Mr Gunther Cohn of Franklin Institute reviewed the paper in Expls & Pyrots 5 (11), 1972

67) H. Ellern, "Military and Civilian Pyrotechnics", Chemical Publishing Co, NY (1968) (2nd Edn) (No specific pages for history)

67a) M. Lindsay, "One Hundred Great Guns: An Illustrated History of Firearms", Walker & Co, NY (1967); reviewed in Ordn 53, 99 (1968). *→ checked by me 12/1/74*
Gonnes, the earliest firearms, are listed on pp 29-33. (See also "Gonne" in Vol 6 of Encycl, p G 120-R)

68) Coll, "Blasters' Handbook", Published by E.I. duPont & Co, Wilmington, Del (1969), pp 1-6 (Early History of Explosives); pp 7-24 (DuPont's Role Today) (See also Ref 62)

69) R.E. Dupuy & T.N. Dupuy, "The Encyclopedia of Military History from 3500BC to the Present", Harper & Row, NY & Evanston (1970), pp 1-4 (Warfare begins); 15 (Early Chinese military organization) and other pp indicated in the text of this compilation)

70) Anon, "Engineering Design Handbook, Properties of Explosives of Military Interest", US Army Materiel Command Pamphlet AMCP 706-177, Jan 1971, pp indicated in the text

71) A.G. Gorst, "Porokha i Vzryvchatyive Veshchestva" (Powders and Explosive Substances), Izdat Mashinostroyeniye, Moscow (1972), pp 5-17 (A brief historical description)

72) "Blasters' Handbook", 1973, Explosives Division, Canadian Industries Ltd, 6320 Dorchester Bldg, W. Montreal, Quebec [Reviewed in Expls&Pyrots 7 (12), 1974]

73) C. Belgrano, "Gli Esplosivi", Arti Grafiche Friulane, Udine, 2nd Edn (1974), 9-15 (Brevi cenni storiei sugli esplosivi)

"Hive of Bees". A Japanese pyrotechnic device of WWII, which consisted of a six by one inch cardboard (called Hive), mounted on a wooden block and provided with a fuse. The "Hive" was filled with miniature BkPdr. charges (called "Bees")

When ignited by a fuse the "Hive" injected a plume of smoke followed by some object shot at high speed and buzzed furiously away.

This display was followed by a machine-gun succession of "Bees", which may be called miniature unguided BkPdr rockets launched from a Roman candle

Refs: 1) Barry Rothman, Colt Industries, Firearms Div, Pyrotechnics Operation 2) Explosives & Pyrotechnics Vol 2, No 4, p 3 (1969)

HMSO—Abbreviation for Her Majesty's Stationary Office (in London), which is the British Institution which corresponds to the US Government Printing Office (in Washington, DC)

HMT—See Hexamethylenetetramine in this Vol

HMTD—See Hexamethylenetriperoxidodiamine in this Vol

HMX (High Melting Explosive or Her Majesty's Explosive). See CYCLOTETRAMETHYLENE-TETRANITRAMINE in Vol 3, pp C605-R to C610-R. It exists in four polymorphs of which beta-HMX is described on pp C606-R to C609-R and in AMCP 706-177 (1967), pp 173-77

HMX-Nylon Plastic Bonded Explosive. See Nylon-HMX Plastic Bonded Explosive

HNM: Hexanitromannitol. See Mannitol Hexanitrate in Vol 8

HNO. Abbrn for 2,4,6,2',4',6'—Hexanitroxanilide, described under Oxanilide and Derivatives and in AMCP 706-177 (1967), pp 170-72

HNS. Abbrn for Hexanitrostilbene, also called Hexanitrodiphenylethylene. See Diphenylethylenehexanitro in Vol 5, p D1456-R

Hoch- und Niederdruckkanone (High and Low Pressure Gun, abbreviated to H/L Gun) (Canon à tuère, in French). It has been known for a long time that the lower the peak pressure in a gun the thinner may be the walls of the projectile. This means that for a given total weight the projectile, used in a gun with lower peak pressure, can contain more explosive and do more damage to a target

This is of particular importance in the use of shaped charges because the penetration of

targets does not depend upon the strength of the case (shell) but on the amount of the explosive charge. In order to achieve low pressure in a gun of conventional design, the barrel should be made longer and the chamber and cartridge case larger. Such guns were built but were found to be unsuitable because the propellant was difficult to ignite and it burned irregularly (due to the low pressure in the chamber). Also, the initial velocity of the projectile varied from round to round which means that no precision firing could be achieved

Better results were obtained in 1943 when Dr. Hermann and collaborators of the Rheinmetall-Borsig AG constructed the *8cm PWK 43* (80mm Antitank Gun). The description of this gun, called in French "canon antichar modèle 1943," was given by Travers and Touchard (Ref 3). They claimed that the "turbocanon Delamare-Maze," invented in France about 20 years earlier, may be considered as the predecessor of both the H/L and recoilless guns

The German gun, 8cm PWK 43, had a comparatively thin barrel with an inside diameter of 81mm and was 34 calibers long; the chamber had an enlarged diameter (105mm) and much thicker walls. The projectile (fintail type, 81mm in diameter, contained a shaped charge and weighed 3kg) was inserted first in the bore (as in separate-loading ammunition). This was followed by the cartridge (120mm long and 105 mm in diameter) which contained the propellant. The cartridge was closed by means of a disc provided with eight perforations (each 13mm in diameter). When the propellant burned the pressure of the gases developed inside the cartridge was about 850 kg/cm² but the pressure acting on the projectile was only 550 kg/cm² because the gases lost part of their velocity on passing through the holes in the disc

The relation between the high pressure inside the cartridge case and the lower pressure in the bore could be varied by increasing or decreasing the size or number of the openings in the separating disc. In order to protect the propellant in the container from spilling and from moisture, the perforated metallic disc was covered with a solid disc of paraffined cardboard

The ballistics for the H/L gun were worked out by Travers and Touchard in France and by

Corner in England

Note: Corner stated that towards the end of WWII the Germans started to manufacture two light antitank guns: the 8cm PAW 600 and the 10.5cm PAW 1000, but does not describe them. He also mentioned the 8.8cm W71 gun, which was built on the "three-pressure principle"

Refs: 1) J. Corner, J Franklin Inst **246**, 233 (1948)
 2) J. Corner, "Theory of the Internal Ballistics of Guns," J. Wiley, NY (1950), pp 312-327
 3) S. Travers & L. Touchard, Mém Artill Fr **26**, 835-58 (1952)
 4) Ibid, **27**, 219-36 & 245-78 (1953)
 4) PATR **2510** (1958), pp Ger 90-R & Ger 91-L

Hochdruckpumpe (HDP) oder V-3 (High Pressure Pump, called also "Busy Lizzie" or "Múltipede") a German constant-pressure gun developed during WW II by Condors, an engineer of the firm Röchling, Saarbrücken, and intended to fire the Arrow (Needle) Projectile (qv) across the Channel to London. The barrel, caliber 150mm (5.9"), was of unalloyed crucible cast steel made up of a great many Y-shaped sections, each 12 to 16 ft long. With a gun about 450 ft long containing about 28 propellant chambers (distributed along the bore), a muzzle velocity of about 4500 ft/sec and a range of about 130 km was expected to be achieved (when using a projectile 8 ft long and weighing 150 lb)

The gun could lie on the ground without any carriage on wooden and concrete blocks sloped at a 45° angle. The fin-stabilized, arrow projectile was inserted in the barrel and the base propellant charge electrically ignited. As the projectile passed the separate Y-pieces, additional propellant charges in the side arms were electrically ignited one after another (in pairs) thus accelerating the velocity of the projectile as it progressed along the gun barrel

For servicing (reloading the Y-sections with propellant charges between the rounds), the gun required a great many soldiers. It was planned to fire one round per gun every 5 minutes but this rate could not always be achieved because the sections often exploded and it was necessary to insert new Y-pieces

Refs: 1) L.E. Simon, German Research in World War II, J. Wiley, NY (1947), pp 191-3
 2) W. Dornberger, "V-2," Viking, NY (1954),

p 247 3) A. I. Sprinz & H. H. Bullock of Picatinny Arsenal; private communication 4) PATR **2510**, p Ger 90-L & R

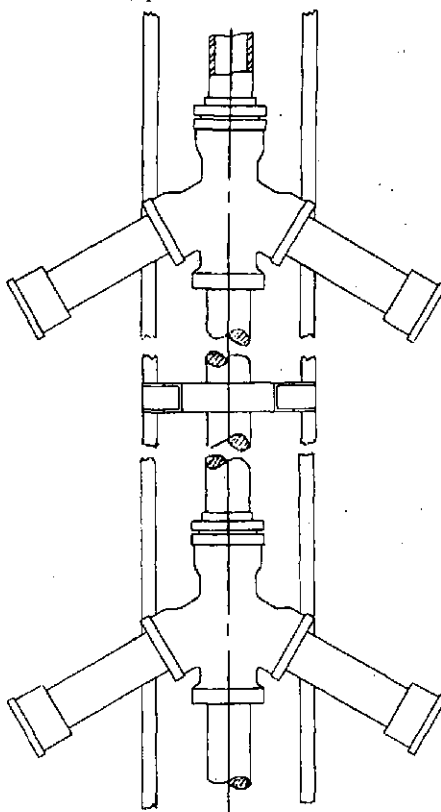

HDP Supergun
 (Vergeltungswaffe 3)
 (V-3)

Hochexplosivkörper. Ger for High Explosives (HE's)

Hochstätter Powder—patented in 1869 in England was prepd by blending in wet condition $KClO_3$ (or $Pb(ClO_3)_2$), KNO_3 (or $NaNO_3$), charcoal and sulfur (or metallic sulfide) and impregnating paper or dry vegetable materials with this mixture

Refs: 1) Cundill (1889) in MP **6**, 14 (1893)
 2) Daniel (1902) 376 3) Giua, Trattato **6**, (1959), 392

Hohlladung (Ger for Shaped or Hollow Charge). Considerable work was done in Germany before

2/9/97

and during WW II on the development of shaped charges. Among the most prominent contributors in this field were the personnel of Krümmel Fabrik, DAG. Among the shaped charge weapons developed at Krümmel may be mentioned:

- a) Magnetic anti-tank shaped charge weighing 3 kg; blast penetration of armor was up to 250mm
- b) Shaped charges for Faustpatrone, Panzerfaust, Panzerschreck, etc

Note: At Krümmel it was found that the best explosives for shaped charges were RDX-TNB and next, RDX-TNT mixtures. Substituting PETN for RDX led to a decrease in efficiency. The addition of aluminum powder was desirable but not in large quantity

Krümmel was not the only place where work on shaped charges was conducted. Elsewhere the Germans developed a shaped charge shell which was shot from an 80mm mortar called "Panzerwurfkanone", and the warheads for several guided missiles

Historical Discovery of the hollow (shaped) charge (HoC) effect is usually attributed to C. E. Munroe (USA) who described the effect in the *AmerJSci* **36**, 1888. It was claimed by H. Schardin that Max von Förster of Germany had in 1883 already shown that bare hollow charges gave an enhanced effect along the axis of the charge. The first practical application of the HoC effect for demolition charges, sea mines, torpedoes, projectiles etc, was patented in 1910 by E. Neumann & the Westfälisch-Anhaltische Sprengstoff AG (DRP Anm W36269). Neumann's work is described in *SS* **6**, 356 (1911) and *SS* **9**, 183 (1914). Important work on military applications of the HoC effect was done, prior to and during WW II, by H. Schardin et al in Berlin. Some work was also carried out by A. Stettbacher of Switzerland during this period.

Note: According to A. J. Dere, Ordnance Sergeant, October 1945, pp 3-13, hollow (shaped) charge ammunition was used by the Germans in many 75mm caliber weapons. There were at least four types of such projectiles: H1, H1/A, H1/B and H1/C. Most of these projectiles are briefly described in TM 9-1985-3 (1953). Some projectiles of calibers 88mm, 100mm, 105mm and 150mm also had shaped charges

The following drawings represent some typical German hollow charges. (See next page)

Refs: 1) A. Stettbacher, *Nitrocellulose* **8**, 83-84 (1937) 2) O. W. Strickland et al, *PB Rept* **925**, Appendix 3, p 46 and Appendix 7 (1945) 3) H. L. Porter et al, *CIOS Report* 33-27 (1945) 4) L. E. Simon, *German Research in WWII*, Wiley, NY (1947), pp 118-120, 188 5) A. Stettbacher, *Spreng- und Schiesstoffe*, Rascher, Zürich (1948), pp 133-34 6) *PATR* **2510** (1958), p Ger 91-L & R

Note: Gen description of Shaped Charge phenomenon is given in Vol 4, pp D442-R to D454-L under DETONATION, MUNROE-NEUMANN EFFECT AND LINED CAVITY EFFECT IN

Hoitsema's Stability Test: One of two interconnected U-tubes contains 1-2g of explosive, while the 2nd tube contains glass wool impregnated with a solution of 0.1g diphenylamine (DPhA) in 50ml of 50% sulfuric acid and 50ml of CP glycerin. The first tube is heated for 15 minutes at 110° and while heating is continued a current of pure CO₂ is passed through the tubes. If the DPhA reagent turns blue, a new sample is taken and the test repeated at 10° lower and so on until a temp is reached at which the DPhA reagent no longer turns blue

This test differs from Abel's test in using temperature of decomposition rather than time at constant temperature

Ref: Daniel (1902), 679

Hoko. Ger abbrn for *Hochkonzentriert* (Highly Concentrated) *Process* for the manufacture of 98-99.5% nitric acid, developed during WW II, and used in several German plants. In this process, the concentration of the weak acid (50%) was effected by mixing it with liquid nitrogen tetroxide (N₂O₄) and adding the necessary extra oxygen under 50 atm pressure in an autoclave

Description of this method as practiced by the IG Farbenind A-G subsidiary, the Wirtschaftliche Forschungsgesellschaft mbH (WIFO), Embesen, Kr Lüneburg is given in the following BIOS Final Reports: 1232 (1947), pp 15-16 and 1442 (1947), pp 84-98

Hollings patented, in 1898 in England, the method of preparation of compressed charges of wet nitrocellulose in two stages: first by using a worm screw in a cylinder, provided with numerous small perforations, followed by hydraulic pressing. During the first operation air

GERMAN HOLLOW
(SHAPED) CHARGES

H 165

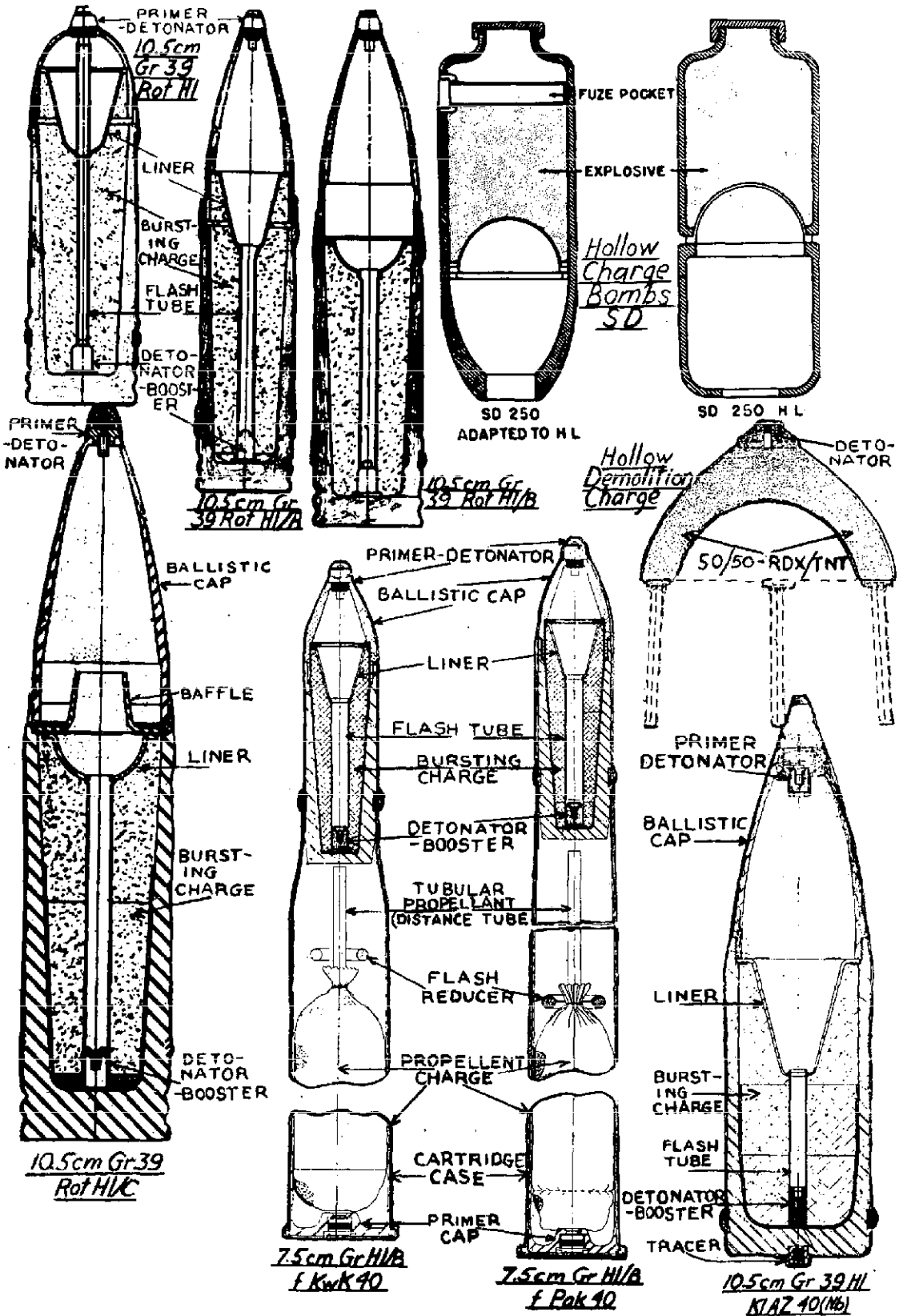

and excess of water are driven off, while in the hydraulic press the NC assumes the desired shape, such as discs, blocks, etc
 Ref: Daniel (1902), 376

Hollow Charge. See Hohlladung (Shaped Charge)

Hollow Charge Nose Attachment for AP Bombs.

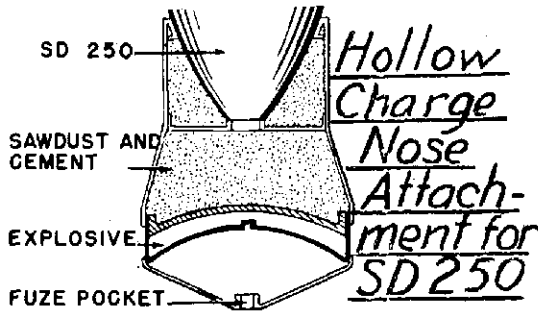

In order to permit greater penetrating power from low altitudes some German 250 kg AP bombs had a hollow charge (weighing about 4 kg) attached to the nose. This charge was detonated by its own nose fuze as soon as it hit the armor. The explosion of the HoC produced a hole in the armor (as deep as 7 cm) which permitted the AP bomb to enter inside the target. The AP bomb being provided with a short delay fuze did not explode until it was inside the target. In order to protect the bomb from premature detonation the space between the HoC and the nose of the bomb was filled with sawdust and cement

Refs: 1) TM9-1985-2(1953), p 5 2) PATR 2510 (1958), pp Ger 91-R & 93-L

Holmgrens: An explosive used in Sweden between 1903 and 1906 for filling shells and claimed to be more suitable for that purpose than PA. No composition is given

Ref: D.H. Hone, SS 1, 109 (1906)

Holocellulose: Cellulosic material obtainable from wood after removal of lignin. The term therefore means total carbohydrates (cellulose and hemicellulose) present in the wood (Refs 1 & 2)

Ritter (Ref 3) succeeded in isolating holocellulose from wood pulp by repeated chlorinations, followed by extraction with alcohol containing 3% of monoethanolamine. The resulting product was white but changed color on standing

Refs: 1) W. Van Beckum & G. J. Ritter, Paper TradeJ, 104 (19), 49 (1937) & CA, 31, 6458 (1937); 105 (18), 127 (1938) & CA, 32, 765 (1938); 108 (7), 29 (1939) and CA, 33, 4017 (1939) 2) Marsh & Wood, Cellulose (1945) p 3 (see p XIII, vol 5 for this abbrn) 3) Dorée, (1947), p 336

Holtex. See Ref 7 thru Ref 11, pp C396-L to C397-L and Addnl Ref K, pp C402-R to C403-L in Vol 3 of Encycl

Holzmine 42. German Landmine developed during WW II

Ref: TM 9-1985-2 (1953), p 263

Homing Guidance Systems. A homing guidance system may be defined as a guidance system by which a missile steers itself toward a target by means of a self-contained mechanism which is activated by some distinguishing characteristic of the target. The homing guidance systems fall under one of the three general types: active homing, semiactive homing, and passive homing. There are possible permutations and combinations of the three basic types, depending upon intended application. The basic homing types also may be employed in conjunction with other guidance techniques. For example, the control of a missile may involve several guidance phases each using a different guidance technique

An active homing guidance system is one in which both the source of energy to illuminate the target and the receiver of the energy reflected from the target are carried in the missile

The active homing guidance system, in its simplest form, consists of a transmitter and receiver of energy, which enable the missile to detect the presence of the target, a computer which predicts from the received energy the future position of the target, and missile control surfaces which respond to computed signals in such a fashion as to direct the missile to impact with the target. The energy used to illuminate the target may be in the form of radio, light, heat, or sound waves. A missile which uses active homing guidance is completely independent once homing starts; the missile does not require energy transmitted from an external source or externally derived guidance intelligence

A semiactive homing guidance system is one wherein the receiver in the missile receives

but machine went down

*edit here
1/10/57*

energy reflected from the target, the energy having been transmitted from a point external to the missile. The semiactive homing guidance system consists of a receiver in the missile which detects the presence of the target, a computer (also in the missile) which predicts from the received energy the future position of the target, missile control surfaces which direct the missile along the correct flight path for impact with the target, and an externally located transmitter which illuminates the target. This external transmitter may be located at the missile launching station, or at a point separated from the missile launching station.

*Search
4/10/57*

The transmitter may be a surface installation or it may be airborne. As in the case of active homing guidance, the transmitted energy may be in the form of radio, heat, or sound waves. The principal difference in the basic operation of an active and a semiactive guidance system is that the semiactive system is not independent of external sources. Its guidance intelligence is derived from energy transmitted from a point external to the missile

A modified version of this semiactive technique has the transmitter located in the missile and the receiver of the reflected energy at some remote point. Computation of the desired flight path takes place at a remote point and suitable commands are sent to the missile. This system is known as a *quasi-active homing guidance* system

A *passive homing guidance* system is a guidance system wherein the receiver in the missile utilizes energy emanating from the target. The basic difference between the passive homing technique and the two preceding techniques is that energy from which the guidance intelligence is derived in the passive homing system is generated in the target; thus no other transmitter is required. In this system, the receiver, computer, and missile control surfaces serve the same functions as described for the previous systems. The energy emanating from the target may be in the form of heat, light, sound, or radio waves

Ref: A. S. Locke, et al, "Guidance," Van Nostrand, NY (1955), pp 541-562

Note: See also Guidance System of a Missile in Vol 6, p G175 to G178

Homocyclonite. One of the names for Cyclo-tetramethylene-tetranitramine (HMX) described under Cyclotetramethylene-tetramine and Derivatives in Vol 3, p C605-R

Homogenization and Homogenizers (See also Emulsification and Emulsifiers). The term "homogenization," according to Sloan (Ref 1), describes the process of putting incompatible or immiscible components into a stabilized, nearly homogenous suspension in a liquid medium. For instance, preparation of various cosmetic creams may be accomplished by homogenization of fats, talc, essential oils, coloring materials etc in water. Homogenization can produce particles of the order of 1 micron diameter, which are smaller than encountered in most natural emulsions, such as milk. As the smaller particles remain in suspension for a longer time than the larger ones, milk passed through a "homogenizer" (an apparatus used for "homogenization") will not separate into cream and skimmed milk, particles of fat and casein are smaller than in ordinary milk, better digestibility is achieved

Many types of homogenizers are on the market, but the most conventional types function by forcing the ingredients (at pressures of 500 to 3000 psi) past a spring-seated valve. Emulsification occurs not only while the components pass under the valve seat, but also when they impinge against the retaining wall that surrounds the valve. The high velocity combined with hydraulic shear, pressure release and impact, transforms the dispersed phase into a very fine state of subdivision

Refs: 1) J. H. Perry, Chem Engineer's Handbook, McGraw-Hill, NY (1950), pp 1167-1168; C. K. Sloan, "Homogenizers"; 4th edit (1963), p 21-17 2) Kirk & Othmer 5 (1950), p 706 (under "Emulsions"); 8 (1965), p 141 (under "Emulsions")

Honest John. Popular name for the US Army 762mm rocket system, a surface-to-surface tactical missile, employing a solid proplnt. It is launched from a rail-type launcher at an elevation which can be varied to obtain the desired point of impact. Honest John carries either a conventional HE warhead or a nuclear warhead

Ref: OrdTechTerm (1962), p 156-L

Honey (Miel in French). A sweet, sticky substance made by the honey bee from the juices it collected from flowers. It can be nitrated to:

Nitrohoney (Nitromiel). Nitration is best conducted in mixtures of honey and glycerin, using the acids and procedure described under Nitroglycerin. The explosive properties of this mixed explosive are similar to those of Nitrohydrin (qv). "Nitrohoney" was patented for use in the so-called Thunder Powder (qv) Ref: Daniel (1902), p 564 under Nitromiel and p 767 under "Thunder Powder"

Hop Record of a Gun Carriage or Mount. The hop is defined as the motion of the carriage (or mount) from the instant of firing until equilibrium is attained. The "hop" record is a measure of the carriage (or mount) stability. The equipment and methods of testing are given in Ordnance Proof Manual No 40-78 (1943)

Ho-pao. A kind of incendiary charge resembling Greek fire, employed by the Mongols in the 13th century

Ref: Daniel (1902) 377

Hope patented in 1884 in England—Black Powder in which part of charcoal is replaced by starch, flour, sugar, or other organic substances. Some bitumen, or other solid hydrocarbons was included in order to obtain more complete combustion Ref: Daniel (1902) 377

Hopkinson's Pressure Bar Test. See under Physical Tests for Determining Explosive and Other Properties in Vol 1 of Encycl, p XVI

Horn-Seifert Stability Test. In the original test of Horn, 2g of smokeless proplnt was heated to 120° in a long test tube until brown fumes of nitrogen dioxide evolved. The degree of decomposition of the proplnt was judged approximately by the intensity of brown coloration as observed by looking down the length of the tube against a disc of white porcelain (Ref 2)

Seifert (Ref 1) modified the test by introducing a test paper (methyl violet or rosaniline) and observing the successive changes of color Refs: 1) Seifert, Vovenske-Technicke Zpravny (Prague), 4, 42 (1927) 2) Reilly (1938) p 79

Hornet Ball Cartridge. See under Cartridge, Ammunition in Vol 2, p C74-L

Horns. Metallic projections (lead, steel or copper) on top and/or sides of underwater mines, serving as initiators. Horns are of several types but the most common is the "chemical horn," which contains glass vials filled with acid. When the ship hits one of these horns, it breaks the glass vial and the acid then flows between electrodes of a battery causing a current to be generated. The current fires an electric detonator, which causes detonation of the main charge of the mine

Ref: Glossary of Ordn (1959), p 151-L; Ord-TechTerm (1962), p 156-L

Horse Detonator. The name given to the American "M46" fuze because it can initiate much more effectively than standard fuzes, such as the Mark III. The "M46 fuze" can be used even with the worst exuding shell, where the standard fuzes nearly always fail. It compensates for both desensitized boosters and bursting charges. In all cases, it gives high-order detonations

Ref: War Dept Tech Manual, TM9-1901 (1944), p 135

Horsedung Explosive. A blasting explosive composed of K nitrate 12 parts, horsedung dust 1, charcoal 1 & sulfur 3 parts

Ref: Deutsche Praeposit-Werke Karlsruhe, GerP 231598 (1907); CA 5, 2725 (1911)

Horsley Dynamites authorized in 1872 in England were prepd by mixing at least 73 parts of NG with the following pre-pulverized mixtures: a) KClO₃ 75 & gallnut 25% (Ref 3) or b) KClO₃ 75, gallnut 12.5 & charcoal 12.5% (Ref 1)

According to Daniel (Ref 2), a mixt of KClO₃ & NG, known as *Seranine* (qv) was proposed by Horsley. Another mixture, also known as *Seranine* was proposed by Björkmann (Ref 2) Refs: 1) Cundill (1899) in MP 6 14 (1892) 2) Daniel (1902) 713 3) Giua, Trattato 6 (1959), 392

Hot Bar Test of High and Low Explosives. It is one of the tests used for the determination of ignition (deflagration or explosion) temper-

ature. The test originated in Spain and is described in Marshall (Ref 3) under the name "Temperature of Ignition." The apparatus shown in Fig 83, p 436 is reproduced here (qv)

mean of the thermometer readings, when explosion occurred, was taken as the temperature of ignition. This method was used in Spain for testing NC propellants. If the ignition temp was 180° the sample was considered good; if it was between 178° & 180°, it was serviceable; if between 176° & 178° it had to be used immediately; and if below 176° the sample was destroyed

Note 1: Instead of heating the bar by gas burners, it can be heated electrically, such as described by E. Berl & G. Rueff in *Cellulosechemie* 14, 43 (1933). The bar, known as *Bloc Maquenne*, generally used in France for determining melting points, could be adopted for use in determining the ignition (or explosion) point

Note 2: Fisher Melting Point Apparatus, described by Fisher Scientific Co, Pittsburgh, Pa (1970), p 640, can also be used for determining ignition (or explosion) temperature

Note 3: Hot bar and other methods for determining ignition (or explosion) temperature are described in the following refs

Refs: 1) A.P. Sy, *JFranklInst* 155, 171 (1903) (Early US Ordnance method, also described in Refs 2 & 4) 2) Marshall 2 (1917), 434-35 (same method as in Ref 1) 3) Marshall 2 (1917), 435 (Hot bar method) 4) Reilly (1938) 83 (same method as in Ref 1 is listed as Deflagration Test) 5) PATR 2700, Vol 1 (1960) pp XVI & XVII (description of two tests and list of 11 refs) 6) AMCP 706-177 (1971), p 3 (current US Ordnance Explosion Temperature Determination) 7) PATR 2700, Vol 6 (1973) p E387-R (Explosion Temperature)

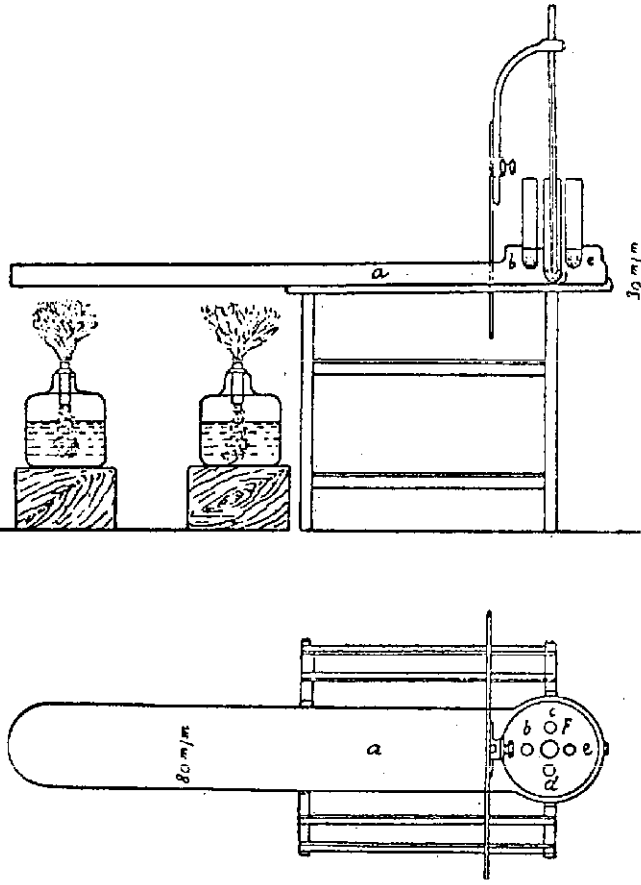

Fig 83. Apparatus for Determining the Temperature of Ignition

The copper bar (a) had a circular enlargement at one end in which there were five holes; the central one (F) contd mercury in which the bulb of a thermometer was immersed; a small copper tube, contg 0.1g of pulverized explosive to be tested, was placed in each of the other holes. The bar was supported on a stand and was heated by means of burners placed underneath it. The rate of heating could be regulated by moving the burners. The expl sample in tube (b) exploded first, then in (c) and (d) and finally (e). The

Hot Extrusion of Shells. A modification of the Ugine-Sejournet hot extrusion process (using glass as lubricant) is used by Scaife Company of Oakmont, Pennsylvania. In this process a complete shell (such as 4.2 inch) can be produced in one piece from a simple billet. Important features of the development are in the substitution of readily available billet stock for seamless steel tubing, a critical material in times of war. Another feature of this process is that it requires about 25% less steel

Refs: Ordnance, 38, 753 (1954) 2) Iron Age (April 1954) pp 98-102

Hot Spots

Introduction. A hot spot is a localized region of higher-than-average temperature. In explosion phenomena, the term "hot spot" is usually associated with the name of Bowden, although many other investigators have invoked the concept and contributed to its understanding

There is a great deal of evidence that most explosive sensitivity phenomena are understandable in terms of the thermal decomposition of the explosive involved. Some of the early work on the interpretation of *impact* and *friction* sensitivity of explosives in terms of thermal effects is excellently summarized by Bowden & Yoffe (Ref 1). More recent studies which also include investigations of irradiation of explosives by nuclear particles and ionizing radiations are also reviewed by these authors (Ref 2), and by Bowden (Ref 7)

Cook (Ref 3) summarizes the adiabatic decomposition of explosives. Still more recently Bowden (Ref 7) reviewed energy localization effects in single crystals. (See Voi 4, pp D563-69). All these reviews as well as more studies (to be discussed below) emphasize the thermal nature of explosive initiation. Two simple examples will reveal that the thermal energy to produce initiation must be highly localized, ie unless the input energy, known to produce explosions, is concentrated into *hot spots* no explosions can occur

1) In the B of M impact machine small samples of RDX explode at around 30 cm drops of a 2 kg weight. Assuming that all the drop energy goes into heating a 20 mg sample with no heat loss, then the maximum uniform temperature of the RDX is only ca 250°. At 250° the ignition lag for RDX is of the order of 1 sec, whereas it is found (Refs 1 & 3) that under impact measurement conditions the time lags are only several hundred microseconds or at least 1000-fold shorter. Clearly the impact energy must create *hot spots* that are at a considerably higher temp than 250°

2) For PETN compacts of about 90% of crystal density, the 50% threshold for shock initiation is about 9 kbar. This threshold is very nearly the same for large diameter plane-wave tests (Ref 18) and for small diameter, divergent wave gap tests (Ref 17). From the Hugoniot data in Ref 17, the particle velocity, u_p , corresponding

to 9 kbar in the PETN is ca 0.30 mm/microsec. If all this Hugoniot energy ($1/2 u_p^2$) goes into heat (and it certainly does not) the max uniform temp rise of the PETN is only ca 36° which is clearly insufficient to even start slow decomposition in the PETN, to say nothing of producing a detonation in the observed shock initiation times which are of the order of 1 microsec. Obviously the shock energy must be concentrated in *hot spots*

Hot Spot Generation Mechanisms. Although there is general consensus on the existence of hot spots, there is far less agreement on their means of generation or the mechanisms by which they initiate explosions. Some of the possible modes of hot spot generation are:

- a) an adiabatic heating of compressed gas spaces (Refs 1 & 2)
- b) a frictional hot spot on the confining surface or on a grit particle (Ref 1 & 2)
- c) intercrystalline friction of the explosive itself (Ref 1 & 2)
- d) viscous heating of the explosive at high rates of shear (Ref 1)
- e) heating of a sharp point when it is deformed plastically (Ref 2, p 76)
- f) mutual reinforcement of relatively weak shock waves, probably at inhomogeneities in the shocked medium (Refs 7,8,10 & 16)
- g) stagnation of particles spalled off a crystallite by the incoming shock and then stopped after flying across an air gap (the gap can be a void), by a neighboring crystallite (Ref 11)
- h) Micro-Munro jets formed by shocking bubbles, cavities or voids whose interface (between solid or liquid and the cavity) is concave (Ref 7)

Modes a), b) & c) presumably operate in the usual impact and/or friction initiation of pressed solid explosives, and modes a) & b) in the impact and/or friction initiation of liquid explosives. Modes e), f), g) & h) operate in the shock initiation (and possibly the propagation) of detonation in solid explosive compacts or explosive liquids containing inhomogeneities. Mode d) is operative only at strong shock inputs and may be the main mode of initiation and propagation in homogeneous explosive liquids or defect-free explosive single crystals

Theoretical Development. The foregoing shows

the complexity of the phenomena involved in generating hot spots. The mechanism by which hot spots initiate explosions is even more complicated since it involves:

- 1) dissipation of the externally applied energy leading to heat liberation in the materials during which the material is not heated uniformly, but at localized sites to form hot spots
- 2) thermal explosion of the hot spot
- 3) generation of a self-propagating process in the material, resulting in explosion

As full theoretical discussion of this problem involves enormous difficulties, of both physical and mathematical nature, the practice nowadays is to make use of calculations based on an idealized picture of the phenomenon. These idealizations are based on the following assumptions:

- a) during hot spot formation an insignificant amount of chemical reaction takes place, ie the first and the second steps are clearly separated in time
- b) the initial temperature profile in the hot spot is square wave
- c) an exothermic first or zeroth order reaction not accompanied by any phase transformation or other physicochemical processes occurs in the hot spot and the medium

The real picture is naturally much more complicated. Some of the complications arising from the requirements of energy transfer from inhomogeneities to the explosive will be discussed in a later section

The basic equation governing hot spot phenomena is:

$$c\rho \frac{\partial T}{\partial t} = Qk_0 \exp(-E/RT) + \lambda \left(\frac{\partial^2 T}{\partial x^2} + \frac{n}{x} \frac{\partial T}{\partial x} \right) \dots [1]$$

where (Eq 1)

$$0 \leq x < \infty \text{ and } t \geq 0$$

with conditions:

$$t=0 \begin{cases} T=T_0 & x < r \\ T=T_1 & x > r \end{cases} \quad T_0 > T_1$$

$$t \geq 0, \quad x=0, \quad \frac{\partial T}{\partial x} = 0 \quad x=\infty, \quad \frac{\partial T}{\partial x} = 0$$

Symbols

- T Absolute temperature
- x Space coordinate
- t Time
- T_0 Initial hot spot temperature
- T_1 Medium temperature
- r Hot spot radius
- Q Heat of reaction
- E Activation energy
- k_0 Pre-exponential factor
- c Specific heat
- λ Thermal conductivity coefficient
- ρ Density
- n Hot spot symmetry factor
 - $\begin{cases} n=0 & \text{planar hot spot} \\ n=1 & \text{cylindrical hot spot} \\ n=2 & \text{spherical hot spot} \end{cases}$

The exact solution of Eq 1 is unknown. Only numerical or approximate analytical solutions are available. Solutions are obtained in terms of dimensionless variables and parameters, eg: *used here 2/14/59*

Variables:

$$\theta = \frac{E}{RT_0} (T - T_0); \quad \xi = \frac{x}{r};$$

$$\tau = t \frac{Q}{c\rho} \frac{E}{RT_0^2} k_0 \exp(-E/RT_0)$$

Parameters:

$$\delta = \frac{Q}{\lambda} \frac{E}{RT_0^2} k_0 \exp(-E/RT_0);$$

$$\theta_0 = \frac{E}{RT_0} (T_0 - T_1); \quad \beta = \frac{RT_0}{E} \quad (\text{Eq 2})$$

by Merzhanov (Ref 14) and

$$\theta' = \frac{RT}{E}; \quad \xi' = x \left(\frac{RQk_0}{\lambda E} \right)^{1/2}; \quad \tau' = \frac{RQk_0}{c\rho E} t$$

Parameters:

$$\theta'_0 = \frac{RT_0}{E}; \quad \theta'_1 = \frac{RT_1}{E}; \quad \xi'_0 = r \left(\frac{RQk_0}{\lambda E} \right)^{1/2} \quad (\text{Eq 3})$$

by Friedman (Ref 15)

In terms of the first (Merzhanov) set of dimensionless variables Eq 1 takes the form:

$$\frac{\partial \theta}{\partial \tau} = \exp \theta + \frac{1}{\delta} \left(\frac{\partial^2 \theta}{\partial \xi^2} + \frac{n}{\xi} \frac{\partial \theta}{\partial \xi} \right)$$

$$\tau=0 \begin{cases} \theta=0 & \xi < 1 \\ \theta=-\theta_0 & \xi > 1 \end{cases} \quad \theta_0 > 0$$

$$\tau \geq 0 \quad \xi=0 \quad \frac{\partial \theta}{\partial \xi} = 0 \quad \xi=\infty \quad \frac{\partial \theta}{\partial \xi} = 0 \quad (\text{Eqs 4})$$

In Merzhanov's treatment the hot spot problem, as well as ordinary problems of thermal explosion, involves a critical value of the parameter δ which is a function of parameter θ_0 , namely

$$\delta_n = f_n(\theta_0) \tag{Eq 5}$$

Merzhanov states that the results of numerical calculations for spherical, cylindrical and planar hot spots fit the single empirical formula:

$$\delta_n = d_n (\ln \theta_0)^{m_n}$$

where d_n & m_n are (for $4 < \theta_0 < 25$):

$n=0$	$d_0 = 2.66$	$m_0 = 1.3$
$n=1$	$d_1 = 7.39$	$m_1 = 0.83$
$n=2$	$d_2 = 12.1$	$m_2 = 0.6$

Numerical solutions can be invalid outside the computational range for which they are made, and it is frequently cumbersome to use them in establishing the functional dependence of the solution on the variables of the process. Thus even approximate analytical solutions are often more instructive than the more accurate numerical solutions. However considerable caution must be used in this approach, since some of the approximations, employed to make the equations tractable, can lead to erroneous answers. A number of approximate solution for the hot spot system (Eq 1) are reviewed by Merzhanov and their shortcomings are pointed out (Ref 14). More recently, Friedman (Ref 15) has developed approximate analytical solutions for a planar (semi-infinite slab) hot spot. These were discussed in Sec 4 of *Heat Effects* on p H39-R of this Vol. To compare Friedman's approximate solutions with the "exact" numerical solution of Merzhanov we computed r , the hot spot half-width, of a planar hot spot by both methods using the same thermal & kinetic parameters in both calculations. Over a wide range of input variables, the numerical solution gives values of r which are 33 to 43% greater than the r 's of the approximate solution. Thus it appears that the approximate solution, from which the effect of the process variables are much easier to discern than from the numerical solution, gives answers that differ from the exact numerical solution by a nearly constant factor

Other methods of making hot spot calculations are reviewed in Chap 10 of Ref 18. This Ref gives generalized, non-dimensioned curves for estimating hot spot temperatures and dimensions

As an example of the usefulness of approximate solutions of Eq 1, let us consider how to compute the explosion time of a planar hot spot whose temperature and radius are given. A rough, but as will be shown, not too bad an estimate is obtained from solutions of the adiabatic explosion time equation:

$$\tau_a^2 = (\theta_0')^2 \exp(1/\theta_0') / a_c^2 \tag{Eq 6}$$

where $a_c^2 = \rho R Q k_0 r^2 / \lambda E$, and the dimensionless τ_a^2 is then converted into actual time via Eq 3. More accurately the explosion time, τ' , can be obtained from Friedman's results (Ref 15) namely:

$$\exp(-1/4\tau') = \pi^{1/2} (\theta_0' - \theta_1') / 2(\theta_0'^2 - \theta_1'^2) (\bar{\tau}')^{1/2} \tag{Eq 7}$$

$$\text{and } 2(\theta_1')^2 (1 - 2\bar{\tau}') - \theta_1' (2\theta_0' + 1) + \theta_0'^2 = 0$$

where the average explosion time $\bar{\tau}'$ is taken to be 0.14. The following tabulation shows that Eq 7 underestimates τ' , but its values of τ' that are closer to the "exact" (numerical soln of Eq 1) at small θ_0' than those obtained from Eq 6. At large θ_0' the τ' from Eq 6 & 7 are indistinguishable and a little smaller than the exact τ'

θ_0'	0.03	0.04	0.06	0.08	0.10
θ_1'	0.02	0.03	0.03	0.03	0.01
a_c^2	2.28×10^{12}	6.00×10^8	4.36×10^5	1.20×10^4	1.73×10^3
τ' ("exact")	0.114	0.179	0.141	0.150	0.138
τ' (Eq 7)	0.107	0.161	0.128	0.143	0.124
τ' (Eq 6)	0.150	0.200	0.143	0.144	0.124

In contrast, the "exact" treatment of Merzhanov (Ref 14) does not give even approximate explosion times unless Eqs 4 are solved numerically. ← finished here 1/1/67

Heat flow from a hot spot. One of the earliest recognized manifestations of hot spots was that of entrapped air or gas bubbles initiating explosion in an impacted liquid explosive (Ref 1). Originally Bowden's school suggested that heat from the adiabatic compression of such gas bubbles initiated explosion in the surrounding liquid. Johansson & coworkers (Ref 4), however, pointed out that heat flow from a compressed gas bubble to the surrounding liquid is much too slow to account for the observed phenomena, particularly at low impact energies. They have shown that to achieve explosion fine droplets

of liquid or the creation of foam are necessary within the compressed gas bubble. They also point out that too large a mass of droplets or foam within the bubble can result in too low a temperature of this mass. This immediately suggests a critical condition for explosion, namely, enough hot material within the compressed bubble to ignite the surrounding explosive after this material undergoes thermal explosion, but not so much material that its temperature rise (due to heat flow from the compressed gas) is too low for its thermal explosion. This criticality may account for the wide spread of results usually observed in the impact testing of explosives

Hydrodynamic hot spots. For initiation via impact, characteristic times are of the order of several hundred microseconds and explosion usually starts with a deflagration which can turn into a detonation (Refs 1 & 5). For this process the heat flow described above appears to be adequate. However, for initiation of detonation, in granular explosive compacts or explosive liquids containing inhomogeneities, via shock the characteristic times are entirely too short for any appreciable heat flow from the hot spot to the surrounding explosive (Ref 6). Energy transfer from the hot spot to the surroundings is therefore presumed to occur entirely by shock and rarefaction waves. Mader (Ref 7) called this hot spot model the hydrodynamic hot spot and the development of this model is largely due to his work. In Ref 7 Mader considered the shock initiation of nitromethane containing inhomogeneities such as voids or grit particles. To quote Mader:

"In these calculations, the hot spots were idealized in initial geometry, since no method now exists for calculating the reactive dynamics of the actual two-dimensional configuration. In order to retain one-dimensionality in the computations, the hot spot was assumed to be a spherical disturbed region whose density and temperature was uniform throughout. The surrounding shocked nitromethane was likewise uniform in density and temperature. Initially, the fluid was everywhere at rest relative to the center of the hot spot, which was taken as the origin of the space coordinate

Two types of hot spots were considered as representing the extreme possibilities. These are

the "temperature hot spot," in which the density of the hot spot was the same as that of the surrounding nitromethane and the temperature was higher; and the "pressure hot spot," in which the density was also increased. In the pressure hot spot, the density and temperature chosen were values on the single shock Hugoniot. In both cases, the temperature was chosen such that decomposition of the hot spot would occur almost immediately relative to the surrounding nitromethane"

Based on these calculations, his conclusions were:

"The hydrodynamic hot spot is successful as a model for computing the critical sizes of hot spots in shocked nitromethane. The energy transfer in a hydrodynamic hot spot is effected by shock and rarefaction waves. The computed nitromethane hot spots, of reasonable size to result from interactions of a shock with a bubble, may initiate propagating detonation or not within the experimentally observed times of the order of 0.1 μ sec. A hydro-dynamic hot spot may fail to explode if the rarefaction reaches the center of the hot spot before it can adiabatically explode. If the hot spot explodes, it sends a shock wave into the undetonated explosive, which heats the explosive. Whether or not it will initiate propagating detonation depends upon the initial strength of the shock wave and how rapidly the shock strength decreases at the interface"

More recently Mader developed computational procedures that enables him to examine 2-dimensional hot spots (Ref 10). We quote his conclusion of that study:

"The basic processes in the shock initiation of inhomogeneous explosives have been investigated theoretically using the model of a cylinder of nitromethane containing a void or an aluminum pellet. The interaction of a shock with the density discontinuities, the resulting formation of a hot spot, and the buildup to propagating detonation were computed using two-dimensional numerical hydro-dynamics of the "PIC" type with chemical reaction and accurate equations of state. The hot spots formed at aluminum pellets exhibit failure or propagation of detonation in approximately the same manner as the one-dimensional, hydrodynamic hot spots studied previously. The failure of hot spots formed at voids could be studied only in those cases in

which the failure mechanism did not depend on details of the structure of the reaction zone, as this structure could not be reproduced in the calculation"

Mader then reprogrammed his computations for an Eulerian code and considered the interactions of 4 cylindrical voids rather than a single void (Ref 16). He showed that shock interactions with four holes lead to much greater & faster computed nitromethane decomposition than the shock interaction with a single hole for the same initial conditions

He concludes:

"The basic two-dimensional processes involved in the shock initiation of heterogeneous explosives have now been numerically described. The problem that remains is the study of the interaction of a shock with a matrix of holes in three-dimensional geometry. The basic two-dimensional processes involved in the failure of detonation, the failure diameter of explosives, and the "sputtering" initiation observed for density discontinuities near the critical size have been described. The three-dimensional study of the interaction of numerous failures and re-ignited detonations which is necessary for a complete numerical description of these problems must await new computing hardware"

A novel method for estimating hot spot temperatures. An interesting approach towards estimating the hot spot temp during an impact test has been presented by Bobolev & Bolkhovitinov (Ref 5). They suggest that in an impact test in which the test sample is unconfined some of the sample melts because of plastic deformation and the whole sample then behaves as a very viscous liquid.* After considering the heat flow in this system, and taking into account that the melting point of the sample is raised because the pressure increases during impact, (they assume a linear increase with a coefficient $\alpha \approx 0.02^{\circ}/\text{atm}$), they arrive at the following eqn:

$$\frac{1 - \xi^2}{\xi^2} = \frac{3\tau_0 u_* (T_* - T_{\text{melt}})}{2c\rho h (T_* - T_0)}$$

*Note: According to R. E. Winter of Cavendish Labs, Cambridge: "Flat faces of Silver & Lead Azide crystals were initiated when impacted with spherical metal particles, small compared with the

sizes of crystals and above a critical impact energy. Particles impacting below the critical impact energy produced plastic indentations in the crystals. On the basis of these results, it was concluded that explosives can be initiated as a result of *rapid plastic flow*. It is believed that in many cases of impact and shock initiation plastic flow can allow the localization of impact energy required for hot-spot formation" (Ref 20)

where $\xi^* = r^*/R$; r^* = distance from center of the anvil to the spot where explosion starts (determined from the burning trace remaining on the anvil after an impact that produces explosion); τ^* is the observed time from impact to explosion; h is the test sample thickness; c & ρ have their usual meaning; u^* is the critical impact velocity to produce explosion; T^* is the hot spot temperature. They obtain the following results with a 10 kg falling weight:

Explosive	u^* cm/sec	τ^* μsec	ξ^*	T^* °C	τ_{ad}
PETN	240	300	0.15	320	214
RDX	310	210	0.22	470	15
HMX	310	150	0.26	500	

We have added the last column, τ_{ad} , the time lag for an adiabatic thermal explosion at T^* . In our calculation T^* is the temp of a hot spot in the condensed explosive. We used $E=29.2$ kcal/mole & $k_0=1.2 \times 10^{12} \text{sec}^{-1}$ for PETN (J. Roth, Addendum to Bulletin of 6th Army-Navy Solid Propellant Group, p 41, 1950) and $E=41$ kcal/mole & $k_0=3 \times 10^{15} \text{sec}^{-1}$ for RDX (Ref 3). It is clear that $\tau^* \approx \tau_{\text{ad}}$ only for PETN. Why this is so is uncertain at present. However the Bobolev & Bolkhovitinov approach merits further study

As pointed out by Johansson (Ref 4) the temperature of a compressed gas bubble within a condensed explosive is usually much higher than T^* . This is emphasized by the findings of Friedman (Ref 13) who used reflected shocks in a shock tube to ignite explosive dusts and sprays. Friedman claims that his results can be interpreted to mean that bubble hot spot temperatures hot enough to ignite explosives are between 500 & 800°C

A novel hot spot mechanism. Maycock and Grabenstein have observed a piezoelectric effect in single crystal HMX (Ref 12). This effect increases linearly with static load up their max observed field strength of 10v/cm at a load of 400g on a sample

area of 0.42cm^2 . With the *extreme assumption* that the piezoelectric effect continues to increase linearly to much higher pressures, and that shock loading, which constitutes dynamic loading, is no different from static loading, fields of 10^5 to 10^6 v/cm might be generated at shock loadings of 10 to 100 kbars which are pressures typical of shock initiation processes. At such high field strengths electric breakdown and electron avalanche might be expected. This would create hot spots along the breakdown path. It is known (Ref 2) that Ag Azide breaks down and explodes at fields of 100 to 1000 v/cm, but breakdown strengths of secondary explosives, such as HMX, have not been measured

Use of high energy radiation to create hot spots. Attempts have been made to initiate explosives by ionizing radiation such α -particles, high speed electrons, γ -rays, Pions etc (Refs 8 & 9). No initiations were observed. Cerny & Kaufman (Ref 9) take this absence of initiation to indicate failure of the hot spot model. However a crude preliminary calculation, based on the Friedman model (Ref 15), suggests that the dimensions of the Pion heated regions for Lead Azide (Fig 2 of Ref 9) and for RDX (Fig 3 of Ref 9) are smaller than the critical hot spot dimension at the corresponding temperatures

Written by J. ROTH

Refs: 1) Bowden & Yoffe (1952), Chapters II, III & IV 2) Bowden & Yoffe (1958), Chapters IV, V & VII 3) Cook (1958), Chapter 8 4) C.H. Johansson et al, Proc Roy Soc A246, 160 (1958) & CA 52, 21106 (1958) 5) V.K. Bobolev & L.G. Bolhkovitinov, Izv Akad Nauk, SSSR (1960), 754 & CA 56, 10438 (1962) 6) J. Zinn, JChemPhys 36 (7) 1949 (1962) & CA 57, 4921 (1963) 7) F.P. Bowden, Proc 9th Internat Symp on Combustion, p 499-515, Academic Press (1963) 8) C.L. Mader, Phys Fluids 6 (3) 375 (1963) & CA 58, 8844 (1963) 9) J. Cerny & J.V.R. Kaufman, JChemPhys 40 (6), 1736 (1964) & CA 60, 10467 (1964) 10) C.L. Mader, Phys Fluids 8 (10) 1811 (1965) & CA 63, 16120 (1965) 11) J.H. Blackburn & L.B. Seely, Trans Farad Soc 61, 537 (1965) & CA 62, 8924 (1965) 12) J.N. Maycock & D.E. Grabenstein, Science, 152, 508 (1966) & CA 65, 562 (1966) 13) M.H. Friedman, Combustion & Flame 10, 112 (1966) & CA 65, 10416 (1966) 14) A.G.

Merzhanov, Ibid, 341 & CA 66, 47935 (1967) 15) M.H. Friedman, Ibid, 11, 239 (1967) 16) C.L. Mader, Proc 5th ONRSymp Deton (1970) p 177 17) J. Roth, Ibid, p 227 18) D. Stine et al, JAP 41, 3324 (1970) 19) Anon, "Principles of Explosive Behavior" AMCP 706-180 (1972) 20) R.E. Winter, Expl Div Newsletter PA July 1973

Note: A brief description of "hot spots" was given under the title *Detonation, Spot or Hot Spot, Initiation of* in Vol 4, pp D563-R to D569-R, with 34 refs

Howard Powder. Same as Mercuric Fulminate

Howden Dynamite. A mixture compounded in 1870 in San Francisco by J. Howden and consisting of: NG 75 absorbed in a mixture of sugar, magnesium carbonate and potassium nitrate. This Dynamite was stronger and better than Nobel's Kieselguhr Dynamite
Ref: Blasters' Handbook (1952), p 5; (1958) p 5

Howittite. A mixt of PA, K chlorate and Na nitrate, which proved to be very sensitive and unstable. It was not authorized in England
Ref: 1) Cundill (1889) in MP 6, 15 (1893) 2) Daniel (1902), 378

Howitzer. See under Cannon, Gun, Howitzer, Mortar, Rocket and Trench Mortar in Vol 2, p C27-L

HOX. Code name for Di- or Bis (2,2,2-Trinitroethyl) nitramine (BTNEN) described under Diethylamine and Derivatives in Vol 5 of Encycl, pp D1224-R to D1225-L

HS. Chemical warfare symbol (CWS) for "Mustard Gas". See under *H* in Vol 2, p C168-L

Hs (Henschel) Missiles. The following types were developed in Germany before and during WW II:

Hs117 (Henschel 117), also known as **Schmetterling (Butterfly)**, was a rocket propelled, radio - finished here 1/20/67 controlled missile for use against bomber formations. Some versions were for ground-to-air and some air-to-air. It used liq fuel called Tonka and an oxygen carrier called Salbei (qv) (Ref 1, pp 196-201 & Ref 2, p Ger 93-L)

Hs 293 (Henschel 293) was a radio-controlled missile released and directed to the target from an aircraft. The model fully developed and used was the **Hs 293 A-1**. Other models such as Hs 293 A-2, Hs 293 B, Hs 293 C, Hs 293 D, etc were not fully developed (Ref 1, pp 201-03 & Ref 2, p Ger 91-L)

Hs 298 (Henschel 298) was a rocket-propelled, radio-controlled missile designed primarily as an air-to-air weapon to be carried on fighter aircraft as well as the bomber types. There were several versions but the basic type was called **Hs 298 V-2**. It used a solid propellant (Ref 1, pp 203-05 & Ref 2, p Ger 91-L)

Note 1: Salbei was a code name for either 99.5% nitric acid or its mixt with 5-10% concd sulfuric acid, added to suppress corrosion (Ref 1, pp 216 & 231 & Ref 2, p Ger 170-R)

Note 2: Tonka was a liquid rocket fuel, such as a mixt of crude m-xylidine 57 and Triethylamine 43% (Ref 1, p 216 & Ref 2, p Ger 199-R)

Refs: 1) TM 9-1985-2 (1953) 2) PATR 2510 (1958)

HSC (Propellant). Same as Cordite HSC. See under CORDITE in Vol 3 of Encycl, p C535-L

HTA. Abbrn for German mixture consisting of Hexogen (RDX), Trotyl (TNT) and Al (aluminum). One of such mixts contd RDX 40, TNT 40 and Al 20%

Refs: 1) G. Römer, "Reports on Explosives (Germany)", PBL Rept 85160 (1946), p 15
2) PATR 2510 (1958), p Ger 93-R

HTA-3 (USA). Designation of expl mixt consisting of HMX 49, TNT 29 & Al 22% (Type I); HTA-3, Type II contains HMX 49, TNT 28.65, Al 22 & Ca silicate 0.35%; mw 91, OB to CO₂-21%; cast, sp gr 1.90; Brisance by Sand Test 61.3g crushed in 200g Bomb; Detonation Rate for cast unconfined 1.0 inch diam chge 7866 m/sec; Explosion Temperature ca 370° (flames erratically at 5 secs); Friction Pendulum Test—unaffected by fiber or steel shoe; Gas Volume Evolved on Explosion 680cc/g; Heat of Combustion 3687cal/g; Heat of Explosion 1190 cal/g; Heat of Formation, no value reported; Heat, Specific 0.245cal/g/°C; Impact Sensitivity, 2kg Wt: Bur Mines app for 20mg sample, no value reported; PicArsn App for 25mg sample

17 inches; Initiation, Sensitivity to—minimum detonating chge is 0.30g LA; Power by Ballistic Mortar 120% TNT; Rifle Bullet Impact Test in 3/16" steel—90% explns and 10% burnings; Ditto in 1/8" Al—50% explns and 50% unaffected; Sand Test—See Brisance by Sand Test; Sensitivity to Impact—See Impact Sensitivity; Sensitivity to Initiation—See Initiation, Sensitivity to; Stability Test—See Vacuum Stability Test; Vacuum Stability Test at 120°—0.37cc of gas evolved in 40 hrs from 1 g sample; Velocity of Detonation—See Detonation Rate; Viscosity, Efflux—24.8 Saybolt Seconds

Method of manuf of HTA-3 is similar to that used for Torpex, namely: purified TNT is melted by heating it to ca 100° in a steam-jacketed kettle, equipped with a stirrer. Water wet HMX is added slowly to molten TNT, while continuing to stir it and to heat, until all the water is evapd. Aluminum powder is added and the mixture continued to be stirred until uniform and then cooled, with stirring, to obtain a slurry suitable for pouring into shells or bombs to serve as their bursting charges
Refs: 1) G. Silvestro & H. Will III, PA Instrumentation Rept 1232-58 (1958) (Suitability of HTA-3 as HE) 2) Anon, AMCP 706-177 (1967), pp 178-81 & 362 (Torpex); (1971), pp 178-81

HTA-3, Analytical Procedures. Accdg to Pristera (Ref), up to 0.35% of Ca silicate may be used as an additive. The analysis of HTA-3 may be conducted as follows: TNT is extracted with CCl₄; HMX is extracted with acetone; the residue is Al. If Ca silicate is present, the residue is treated with 10% NaOH soln and washed with water, the remainder is Ca silicide
Ref: Frank Pristera (Picatinny Arsenal), "Explosives", in Vol 12, p 449 of "Encyclopedia of Industrial Chemical Analysis", J. Wiley, NY (1971)

HTA-3, US Military Specification's Requirements and Tests are described in Spec MIL-E-46495A(MU) (Nov 1964) with Amendment 1 (April 1972), entitled "Explosive Composition HTA-3", superseding MIL-E-46495(Ord) (Feb 1961)

1. SCOPE

1.1 This specification covers an explosive com-

position having two types (Type I and Type II) designated as HTA-3 for use in the loading of warheads and other ammunition items.

1.2 Classification – Explosive Composition

HTA-3 shall be of the following types as specified:

Type I – See Table II and 3.3 to 3.5

Type II – See Table II and 3.3 to 3.5

3. REQUIREMENTS

3.1 Material – The raw materials used in the manufacture of the composition shall be in accordance with the applicable specification in Table I

TABLE I

Material	Specifications
Octol	MIL-O-45445 – Type I (See 6.4)
HMX	MIL-H-45444 – Type I, Class 2 & 3
TNT	MIL-T-248 – Grade I, Type I
Aluminum	MIL-A-512 – Type III, Grade F, Class 7
Ca Silicate	MIL-C-51077

3.2 Composition – The composition of HTA-3, Type I and Type II shall conform to the applicable chemical requirements specified in Table II when tested as specified in the applicable paragraphs

TABLE II

Material	Percent		Applicable Paragraph
	Type I	Type II	
TNT	29.0±2.0	28.65±2.0	4.3.1.1
HMX	49.0±2.0	49.0±2.0	4.3.1.2
Aluminum	22.0±2.0	22.0±2.0	4.3.1.4
Ca Silicate	–	0.35±0.05	4.3.1.3

3.3 Moisture content – The moisture content of Composition HTA-3, Type I and Type II shall be 0.10 percent maximum, when tested as specified in 4.3.2

3.4 Viscosity – The viscosity of Composition HTA-3, Type I and Type II, shall be 15 efflux seconds, maximum, when tested as specified in 4.3.3. See 6.6

3.5 Density – The density (specific gravity) of HTA-3, Type I and Type II shall be 1.85 grams per cubic centimeter minimum when tested as specified in 4.3.4. See 6.6

4. QUALITY ASSURANCE PROVISIONS.

See in Specification

4.3 TEST METHODS AND PROCEDURES

4.3.1 Composition

4.3.1.1 TNT – Code No 04001 – Place an

accurately weighed portion of approx 2.5g in a 200 ml beaker and add 75ml of benzene saturated with HMX. Cover the beaker with a watch glass and place beaker and contents on a steam bath. Break up the lumps with a glass stirring rod and agitate the solution occasionally by swirling. Remove the beaker and contents from the steam bath when all of the TNT has dissolved, as evidenced by the settling out of the other ingredients. Cool to RT and filter the solution quantitatively thru a tared medium porosity filtering crucible. Transfer any of the insoluble matter remaining in the beaker into the crucible by using an additional 150ml of benzene saturated with HMX. Draw air thru the crucible until the odor of benzene is no longer detectable. Dry the crucible and contents in an oven maintained at 100 ± 5°C for one hour. Cool the crucible and contents in a desiccator and weigh. Retain the crucible and contents for the determinations which follow

Calculate the TNT content of the sample as follows:

$$\text{Percent TNT} = \frac{100(W-A)}{W-(MW)}$$

Where: A = Weight of residue in crucible, g

W = Weight of sample, g

M = Percent moisture, expressed as a decimal (4.3.2)

4.3.1.2 HMX – Code No 05001 – Place the crucible and contents retained from the TNT determination on a filtering apparatus and wash with ten 20ml portions of acetone. Allow each portion of the acetone to remain in contact with the residue in the crucible for one minute before applying suction. Aspirate the crucible and contents until the odor of acetone is no longer detectable. Dry the crucible and contents in an oven maintained at 100 ± 5°C for one hour. Cool in a desiccator and weigh. Wash the crucible and contents with an additional 20ml portion of acetone, and dry and weigh again. Repeat the washings and weighings until constant weight is obtained. Retain the crucible and contents for the determinations which follow

Calculate the HMX content of the sample as follows:

$$\text{Percent HMX} = \frac{100(A-B)}{W-(MW)}$$

Where: A = Weight of residue in crucible retained from 4.3.1.1, g

- B = Weight of residue in crucible, g
 W = Weight of sample, g
 M = Percent moisture, expressed as a decimal (4.3.2)

4.3.1.3 Calcium Silicate – Code No 06001 (applicable to Type II only) – Place the crucible and contents retained from the HMX determination on a filtering apparatus and wash with ten 10ml portions of the NaOH to remain in contact with the residue in the crucible for one minute before applying suction. Caution should be exercised when performing this procedure to preclude a too vigorous reaction between the aluminum and the NaOH. Aspirate the crucible and contents for a minimum of five minutes. Wash the crucible and contents with five 20ml portions of distd water. Dry the crucible and contents in an oven maintained at 100 ±5°C for one hour or until constant weight is obtained. Cool in a desiccator and weigh

Calculate the Calcium Silicate content of the sample as follows:

$$\text{Percent Ca Silicate} = \frac{100 C}{W - (MW)}$$

Where: C = Weight of residue in crucible, g
 W = Weight of sample, g
 M = Percent moisture, expressed as a decimal (4.3.2)

4.3.1.4 Aluminum – Code No 07001

Calculate the aluminum content as follows:

$$\text{Percent Aluminum} = 100 - (A + B + C)$$

Where: A = Percent TNT (4.3.1.1)
 B = Percent HMX (4.3.1.2)
 C = Percent Calcium Silicate (4.3.1.3)

4.3.2 Determination of moisture content

4.3.2.1 Special solvent – The special solvent shall be equal volumes of anhydrous methanol and benzene thoroughly mixed. If necessary the solvents shall be dried by distillation

4.3.2.2 Method – Determine the moisture content in accordance with Method No 101.4 which is described in Specification MIL-STD-650, using solvent indicated in 4.3.2.1

4.3.3 Viscosity – Determine the viscosity (efflux) in accordance with Method No 212.1 which is described in Specification MIL-STD-650. See 6.6

4.3.4 Density – Determine the density in accordance with Method No 203.1 described in Specification MIL-STD-650

NOTE: Use a chunk of the sample to make this determination. See 6.6

5. Preparation for Delivery. See Specification

6. Notes:

6.3 Intended use of HTA-3. As a filler for warheads

6.4 HTA-3 can be made from Octol and the addn of TNT, Al & Ca silicate to conform to the desired compn

6.5 Calculation of control limits. See specification

6.6 The determination of density and viscosity is not necessary when the HTA-3 is manufd at the time of loading

HTP (High Test Peroxide). See under Hydrogen Peroxide in this Vol

Hübner Powder. Smokeless powder prepd by gelatinizing NC with a solution of potassium xanthogenate in alcoholic ether and adding 2-5% of nitronaphthol and nitromolasses or nitrosugar
Ref: Daniel (1902), 378

Hudson Explosive. Explosive mixture intended for use as a bursting charge in shells and prepd in the USA in 1889 by mixing NG with NC, previously dissolved in acetone, ethyl acetate or ether-alcohol mixture
Ref: Daniel (1902) 378

Hudson Maxim Explosive. An explosive patented in the USA for loading HE shells. It was prepd by blending NC 30-40 with NG 70-60. After the mass hardened it was pulverized and thoroughly mixed with 3-4 parts of wet, finely pulped Guncotton
Ref: Van Gelder & Schlatter (1927), 933

Huff-Duff (HFDF—High-frequency direction finder). An electronic long-distance device developed by Americans during WWII which permitted spotting within a split second any ship (such as submarine), or plane at distances much greater than radar's capability
Ref: Staff, Army Ordn 30, 280 (1956)

Hugoniot, more properly called Rankine-Hugoniot or R-H relations, are a series of equations and/or curves that describe conditions at a shock front. These are best illustrated by reference to an idealized plane shock, such as the one shown in Fig 1, and the following set of eqns that describe this shock:

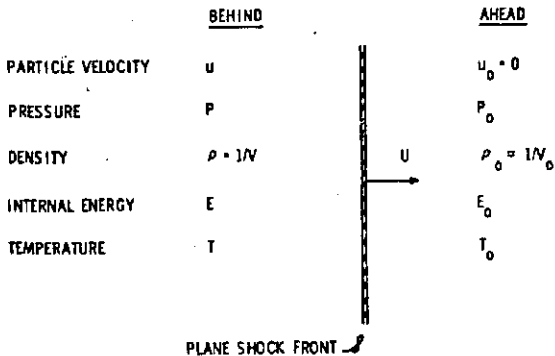

Fig 1 Steady plane shock front propagating into undisturbed materials in laboratory coordinates

$$P - P_0 = \rho_0 u U \tag{1}$$

$$U^2 = V_0^2 (P - P_0) / (V_0 - V) \tag{2}$$

$$u = (1 - \rho_0 / \rho) U \tag{3}$$

$$E - E_0 = 1/2 (V_0 - V) (P + P_0) \tag{4}$$

Of these sets of equations it is Eq 4 that is commonly called the *Hugoniot equation*. Graphical representations of these equations (R-H curves), taken from Ref 20, are shown in Fig 2

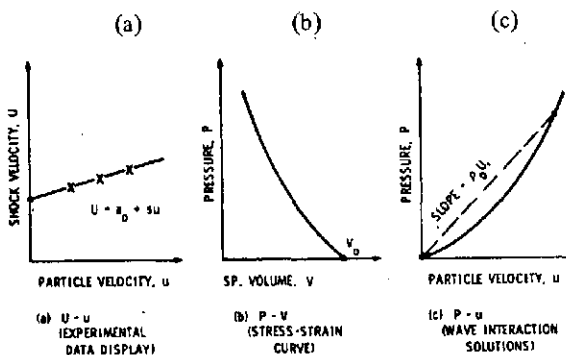

Fig 2 Alternative Hugoniot curves

The curve (c) is a plot of Eq (1); curve (b) is a plot of a combination of Eqs 2 & 3; and curve (a) is empirical, although, in a way, it represents Eq 3, particularly for metals. Here a_0 is the bulk sound velocity in the medium ahead of the shock

As indicated in Fig 2, curve (a) is useful in correlating experimental data, curve (b) is essentially a stress-strain curve, although it has other interesting features which will be discussed later, and curve (c) is most useful in considering shock and rarefaction effects across boundaries of different media

Examination of Eqs 1-3, reveals that the simultaneous measurement of any two shock variables is sufficient to completely specify the remaining variables, provided that initial conditions in the unshocked medium are known. No satisfactory methods of measuring V or ρ are known for condensed media, therefore measurements must be restricted to U, u & P. In Vol 4 of this Encyclopedia methods of measuring U, u & P are described on p D333, p D446 & D485. Theoretical Hugoniot curves for detonation products are shown on pp D706 & 707. More recent methods are reviewed in Ref 21 & 22. A novel electromagnetic method for measuring u is described by Jacobs & Edwards (Ref 20)

An excellent compendium of shock Hugoniot data has been prepared by LRL (Ref 14). It includes some of the earlier Hugoniot data for explosives. These data as well as more recent data are summarized in Table 1 in the form of least square fits to the empirical equation in Fig 2a

Most of the data in Table 1 is for granular explosive compacts. It must be pointed out that defining shock parameters for heterogeneous pellets consisting of explosive granules and air pockets present conceptual difficulties. At best the shock Hugoniot for such materials are useful only for describing the gross hydrodynamic behavior of granular explosives. It cannot be expected that the methods of continuum hydrodynamics applied to discontinuous media will yield any information on the fine structure of the state variables of the shocked explosive.

checked here 1/22/97

Table 1
"Unreacted" Hugoniot Data for Condensed Explosives

HE	ρ_0 (g/cc)	T_0 (°C)	$U = a_0 + Su^*$		Range of u for exp data (mm/usec)
			a_0 (mm/usec)	S	
AN	0.86	25	0.84 (a)	1.42 (a)	0.81-2.32
76/24 Baratol	2.63	25	2.79 + 0.5	1.25 (a)	0.0-2.7
Comp B	1.70	25	3.0 + 0.4	1.73 (a)	0.0-1.5
"	1.68	25	2.71 + 0.05	1.86 + 0.07	0.0-0.9
DATB	1.78	25	2.45 + 0.04	1.89 + 0.06	0.0-1.2
H-6	1.76	25	2.83 + 0.07	1.70 + 0.08	0.0-1.1
H-6	1.76	25	2.65 (a)	1.98 (a)	0.0-2.0
HBX-1	1.75	25	2.93 + 0.08	1.65 + 0.10	0.0-1.0
HBX-3	1.85	25	3.13 + 0.02	1.61 + 0.02	0.0-1.0
HNS	1.38	25	0.61 + 0.21	2.77 + 1.09	0.0-0.5
HNS	1.57	25	1.00 + 0.05	3.21 + 0.10	0.0-0.7
HNS	1.46	260	See Table 4 of Ref 18		
LX-04	1.86	25	-2.7 (a)	-1.9 (a)	0.0-0.6
	1.86		2.36 (a)	2.5 (a)	0.0-0.4
NM	1.14	25	2.00 (a)	1.38 (a)	0.0-1.8
NM	1.14	25	-1.6 (a)	1.65 (a)	1.0-1.7
75/25 Octol	1.80	25	3.01 + 0.4	1.72 (a)	0.0-1.2
PBX 9404	1.84	25	2.45 + 0.21	2.48 + 0.11	0.0-1.45
PBX 9404	1.84	25	2.31 (b)	2.77 (b)	0.0-2.00
PBX 9404	1.77	150	1.85 + 0.54	3.47 + 0.81	0.0-0.8
50/50 Pentolite	1.67	25	2.83 + 0.4	1.91 (a)	0.0-1.2
PETN	0.82	25	0.47 (a)	1.73 (a)	0.76-3.50
PETN	1.0	25	-0.76 (a)	-0.66 (a)	0.28-0.42
PETN	1.59	25	1.33 + 0.08	2.18 + 0.27	0.03-0.37
PETN	1.60	25	1.32 (a)	2.58 (a)	0.2-0.4
PETN	1.72	25	1.83 (a)	3.45 (a)	0.2-0.6
PETN	1.55	110	-0.6 + 0.5	8.7 + 1.7	0.24-0.29
RDX	1.0	25	0.40 (a)	2.00 (a)	0.44-2.60
RDX	1.54	25	-0.7 (a)	3.2 (a)	0.25-0.6
RDX	1.58	180	0.71 + 0.24	4.22 + 0.42	0.25-0.32
RDX	1.64	25	0.70 + 0.18	4.11 + 0.37	0.35-0.47
RDX	1.80	25	2.87 (a)	1.61 (a)	0.75-1.6
RDX	1.64	25	1.93 + 0.05	0.666 + 0.168	0.11-0.35
RDX/EXON 94/6	1.60	25	1.33 (c)	1.99 (c)	0.35-0.93
TATB	1.85	25	2.34 + 0.07	2.32 + 0.08	0.3-1.4

(Continued)

(Continuation)

Table 1
 "Unreacted" Hugoniot Data for Condensed Explosives

HE	ρ_0 (g/cc)	T_0 (°C)	$U = a_0 + Su$ *		Range of u for exp data (mm/μsec)
			a_0 † (mm/μsec)	S†	
Tetryl	1.0	25	0.35 (a)	1.35 (a)	0.76-2.80
Tetryl	1.30	25	2.16 (d)	1.438 (d)	0.3-1.1
Tetryl	1.40	25	1.61 (d)	1.978 (d)	0.3-1.25
Tetryl	1.50	25	2.17 (d)	1.628 (d)	0.3-1.0
Tetryl	1.60	25	2.36 (d)	1.538 (d)	0.3-1.25
Tetryl	1.70	25	2.48 (c)	1.42 (c)	0.4-1.2
TNB	1.64	25	2.32 ± 0.07	2.03 ± 0.12	0.0-0.75
TNT	1.0	25	See Ref 15		
TNT	1.62	25	2.93 (a)	1.61 (a)	0.75-1.6
TNT	1.63	25	2.57 (a)	1.88 (a)	0.0-1.25
TNT	1.62	25	2.27 ± 0.30	2.65 (a)	0.0-0.6
TNT	1.62	25	2.99 (a)	1.36 (a)	1.0-1.5
TNT	1.61	25	2.39 ± 0.03	2.05 ± 0.03	0.0-1.4
TNT	1.64	25	2.08 ± 0.13	2.3 (a)	0.2-1.4
TNT	1.64	25	2.4 (a)	2.1 (a)	0.1-0.5
TNT (liq)	1.47	92	2.14 (a)	1.57 (a)	0.8-1.7

*U = shock velocity, a_0 = bulk sound velocity, u = particle velocity in the HE. S is a constant

† ± terms are twice std deviation

(a) std deviation not given in Refs

(b) based on widely divergent data

(c) although std deviations are not given, data points agree very closely with this fit

(d) $U = a_0' + Su' - S''/u$; thus " a_0 " column gives a_0' , & "S" column gives S' & S''

Moreover, chemical reaction in or near the shock front can cause additional complications. Nevertheless, the data in Table 1 can be very useful as will be shown below, even though, aside from conceptual problems, there is some inconsistency in the data for some of the explosives.

A commonly encountered problem is that of a shock or rarefaction traveling from one medium into another. To solve such problems one converts the U-u data of Table 1 or Ref 14 into P-u data via Eq 1. Then the problem is readily solved by graphical means as illustrated in Figs 3 & 4 (taken from Ref 21)

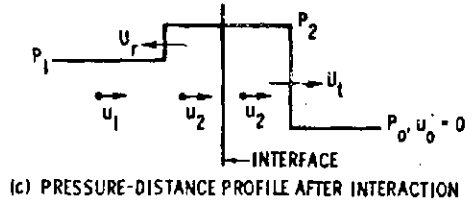
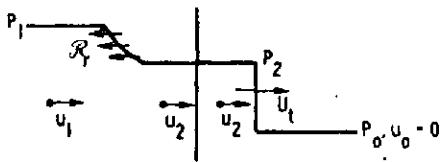
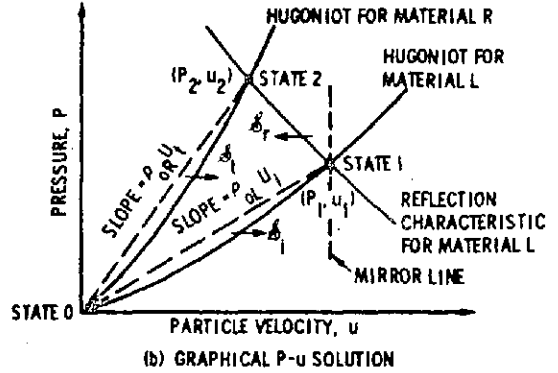
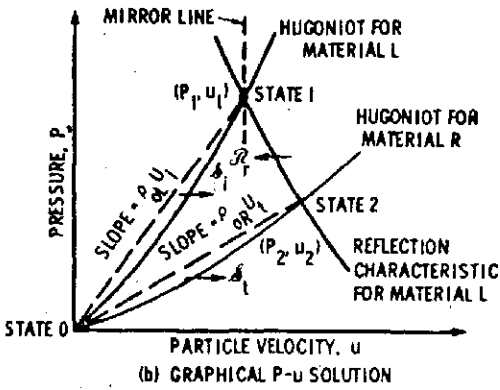
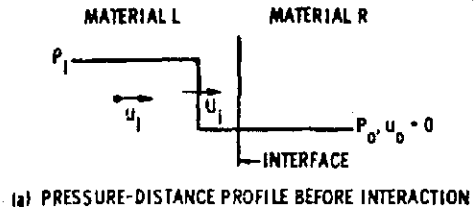
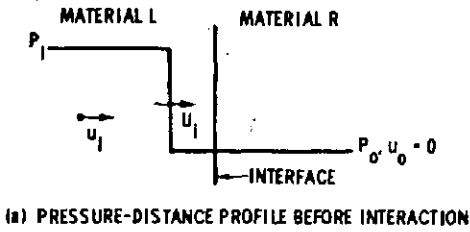

Fig 3 Transmission of a plane shock wave into a material of lower impedance

Fig 4 Transmission of a plane shock wave into a material of higher impedance

Shock impedance is the product $\rho_0 U$ and graphically it is represented by the slopes of the broken lines in Figs 3 & 4. Note that in Fig 3 the reflected wave is a rarefaction rather than a shock. Figure 5 (also from Ref 21) is a useful summary of shock effects in metals, rocks, plastics etc in contact with some common explosives

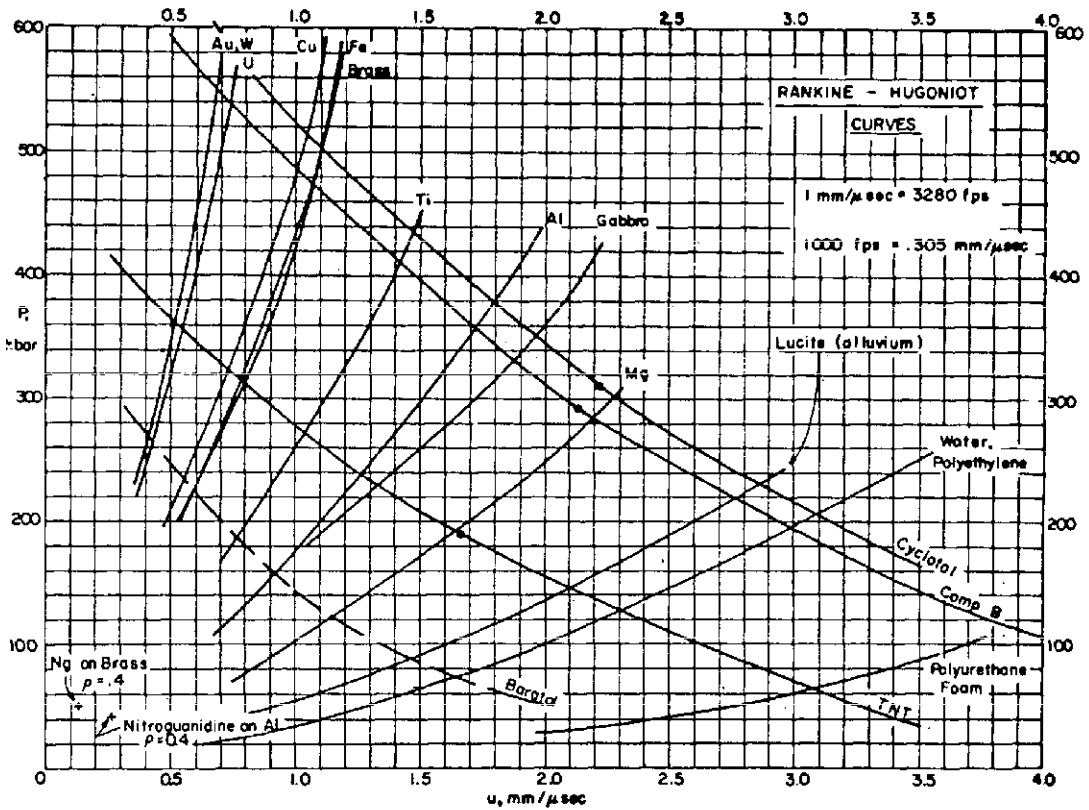
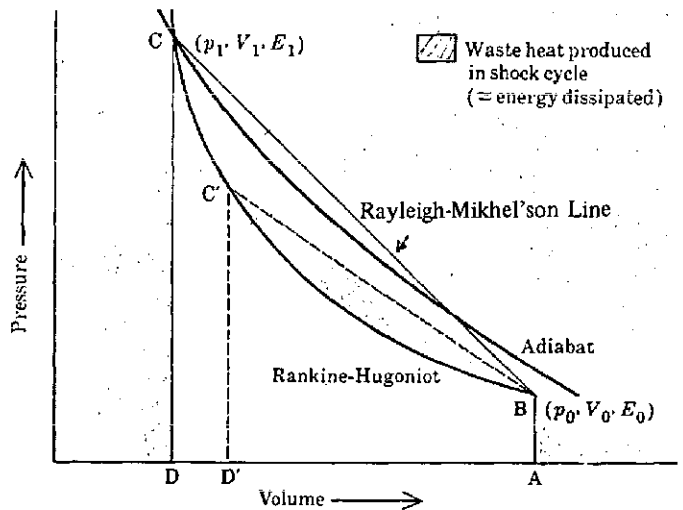

Fig 5 Shock waves induced in various materials by normally-incident plane detonation waves

Other interesting properties of Hugoniot are best viewed in the P-V plane. Figure 6 (taken from Ref 6) is an enlarged and more detailed view of Fig 2b

Fig 6 The Rankine-Hugoniot curve defines states that can be induced in substance by shock compression in terms of pressure (p), specific volume (V), and internal energy (E). Shock compression from initial state B to shocked state C follows the R-H curve and dissipates energy shown by the hatched area. Thus shock compression is not a reversible process—unlike adiabatic compression, which is, at least ideally reversible



Quoting Duvall (Ref 6): "Figure 6 gives the locus of all states (p_1, V_1, E_1 , and so on) that can be reached from an initial state (p_0, V_0, E_0) by shock compression. In an analogous way, the ordinary adiabat or adiabatic curve may be defined as the locus of all states that can be reached by adiabatic compression

At the point B, which represents initial unshocked conditions in the material (p_0, V_0, E_0), the R-H curve and the adiabat have the same slope and curvature, but only at that point: at all higher pressures the R-H curve lies below the adiabat, because unlike adiabatic compression, shock compression dissipates energy, and is, therefore, irreversible

As shown in Fig 6, the increase in internal energy in a shock whose pressure amplitude is p_1 is represented by area ABCD. Loss of energy in a shock can be illustrated by comparing this area thermodynamically with that associated with a weaker shock, area $ABC'D'$, for example. It can also be shown by simple calculation that just as the internal energy increases or decreases as the shock is stronger or weaker, so the entropy of the final shocked state also increases with the shock strength. Although such calculations are valuable in computing the entropy of the shocked state, they are insufficient for calculating the total energy dissipation resulting from passage of the shock wave. However, referring again to Fig 6, the hatched area—bounded below by the Rankine-Hugoniot curve and above by the Rayleigh-Mikhel'son line, a straight line connecting the initial, unshocked point B with the final shocked state C — is a fair approximation to the energy dissipated in the shock cycle. But specifically this area is the waste heat of the cycle, not the energy dissipated. It is difficult to determine an exact expression for energy dissipated because thermal stresses are left behind in the material, even after the shock pressure has been relieved. Therefore, a precise calculation of the true energy dissipation in a decaying shock must account for hard-to-evaluate effects of thermally induced after-flow in the material. In practice we settle for the waste heat approximation"

Duvall (Ref 5) also provides further discussion of P-V Hugoniot curves, eg the manifestations of multiple shocks, phase transitions, elastic limits etc. Cowperthwaite (Ref 11) considers the

thermodynamic consequences of shock Hugoniot data and what additional information is required to specify an equation of state for the shocked medium

Some very interesting information obtainable from Hugoniot data is dramatically illustrated in Fig 7 which is a plot of experimental P-V data (taken from Ref 15) for 1g/cc TNT

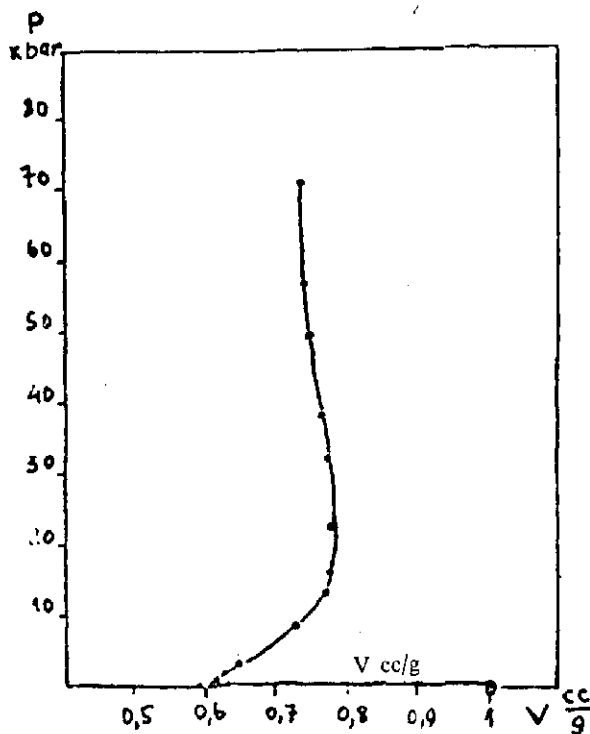

Fig 7 P-V Hugoniot for 1 g/cc TNT

Here the TNT sample is compressed at very low pressures from $V=1$ cc/g to $V\approx 0.62$ cc/g (crystal density). Further compression (increase in pressure) then causes the sample to *expand!* This can only mean that some heat effect is overcoming this compression. Since it can be shown that uniform shock heating at pressures of the order of a few kbars is very small, this heat effect must be produced by exothermic chemical reaction at or very near the shock front. Thus shock Hugoniot for reactive materials can provide information on the presence or absence of chemical reaction at the shock front

Written by J. ROTH

See also Hugoniot in Vol 4, pp D278-R to D281-R and pp D604-L to D607-R
 Refs: 1) W.B. Garn, JChemPhys **32**, 653 (1960) & CA **54**, 14687 (1960) 2) V.S. Ilyukhin et al, DoklAkadNauk, SSSR, **131** (4), 793 (1960) & CA not found 3) A.W. Campbell et al, PhysFluids **4** (4), 498 (1961) & CA not found also B. G. Craig, LASL Rept **GMX-8-M2-62-4** (1962) 4) G.E. Seay et al, JAppl Phys **32** (6), 1092 (1961) & CA **55**, 25254 (1961) 5) G.E. Duvall, Bull Seism Soc of America **52** (4), 869 (1962) & CA not found 6) G.E. Duvall, Science & Technology (April 1963) & CA not found 7) R.J. Wasley et al, Preprints 4th Deton Symp (Oct 1965) p B-109 8) J.B. Ramsay et al, Proc 4th Deton Symp (Oct 1965) ONR, ACR-126, p 233 9) V.M. Boyle et al, Ibid, 241 10) N.L. Coleburn et al, JChemPhys **44** (5), 1929 (1966) & CA **64**, 11019 (1966) 11) M. Cowperthwaite, AmJPhys **34** (11), 1025 (1966) & CA **66**, 22443 (1967) 12) I.E. Lindstrom, JApplPhys **37** (13), 4873 (1966) & CA **66**, 39481 (1967) 13) Anon, SRI Prog Rept **66-2** "Sensitivity Fundamentals," 39 (1966) 14) M. Van Thiel UCRL **50108** "Compendium of Shock Wave Data" (1966) & CA **69**, 99685 (1968) 15) L.G. Bolkhovitinov, 12th Combstn Symp, (1969) & CA **74**, 143971 (1971) 16) I.E. Lindstrom, JApplPhys **41**, 337 (1970) & CA **72**, 80972 (1970) 17) D. Stirpe et al, JApplPhys **41**, 3384 (1970) & CA **73**, 89722 (1970) 18) J. Roth, Proc 5th Deton Symp (Aug 1970) ONR, ACR-184, pp 221-23 19) V.M. Boyle et al, Ibid, pp 254-56 20) S.J. Jacobs et al, Ibid, pp 413-26 21) O.E. Jones, Proc 12th Annual Symp on Behavior & Utilization of Explosive in Engineering Design (March 1972), pp 130-138 22) J.P. Sumner, Ibid, pp 225-34 23) Anon **AMCP 706-180** "Principles of Explosive Behavior" (April 1972)

Huile de Nobel. Fr for NG

Huile détonante, ou Huile explosive. Fr for one of the names for Nitroglycerin.

Hull. The outer covering or husk of any seed or fruit. Some of these substances, for instance, walnut or cocoanut hulls (shells) can be nitrated and probably would produce explosives resembling NC or NS

Hulls, Nitrated. Krüger studied the action of concd (d 1.52) nitric acid on a variety of plant hulls, such as those of chestnuts, walnuts, plumpits, etc. After 12 hours at -10° in the acid a considerable portion of the hulls dissolved leaving a residue (40-60% of the original weight) that contained 11-12%N primarily in the form of nitrate esters. When water was added the dissolved material, a slimy precipitate was formed. It also contained N but less than the residue. Moreover this N was only partly in the form of nitrates

Ref: W. Krüger Ber **73B**, 493 (1940) & CA **34**, 6580 (1940)

Humidification and Humidity. The amount of water vapor in air is referred to as the humidity of air. The controlled increase in humidity is called humidification. The actual moisture content in air is called *absolute* humidity, and the ratio of the weight of water vapor to the weight of water vapor in moisture-saturated air at the same temp (expressed in %) is called *relative humidity* (RH)

Humidity can affect explosives and propellants both adversely and beneficially. If the humidity is very high, an explosive can pick up enough moisture to cause it to deteriorate or malfunction. A prime example of this is Ammonium Nitrate which must be stored and handled in special dehumidified areas to prevent caking. The humidity above which a substance deliquesces, or below which it ceases to be hygroscopic is called the *critical relative humidity* (CRH). It is equal to the humidity in equilibrium with a saturated solution of the substance at a given temperature

On the other hand, humidification can prevent buildup of dangerous electrostatic charges. This is especially important in the handling of such primary explosives as Pb Azide or Styphnate. General references on humidity control & humidification are Refs 2, 4, 5 & 6

CRH's can be used to determine whether a material will deliquesce or if it has a tendency to cake. Thus if the $RH > CRH$ the substance will pick up moisture from the air (deliquesce) until the vapor pressure of water in the deliquescing material equals the partial pressure of water in the surrounding air. Conversely, if $RH < CRH$ any moisture in the material will tend to escape

**Critical Relative Humidities for Some Explosives and
for Ingredients of Explosive and Pyrotechnic Compositions**

Substance	Temperature °C				
	10	20	30	40	Other temperatures
Ammonium chloride, NH_4Cl	75.3	69.8	59.4	52.5	48.4 at 50°
" dichromate, $(\text{NH}_4)_2\text{Cr}_2\text{O}_7$	98.1(c)				
" nitrate, NH_4NO_3	75.0	66	60	53	48.6 at 50°
" oxalate, $(\text{NH}_4)_2\text{C}_2\text{O}_4$	—	98.9(h)			
" perchlorate, NH_4ClO_4	95.6(c)				
" permanganate, $(\text{NH}_4)_2\text{MnO}_4$	99.1(c)				
" sulfate, $(\text{NH}_4)_2\text{SO}_4$	79.4	80	81	79	75 at 108.2°
Barium chloride, $\text{BaCl}_2 \cdot 2\text{H}_2\text{O}$	—	88.0(g)			
" nitrate, $\text{Ba}(\text{NO}_3)_2$	98.8	97.7	—	—	
Calcium chloride, $\text{CaCl}_2 \cdot 6\text{H}_2\text{O}$	38.0	32.3	—	—	
" nitrate, $\text{Ca}(\text{NO}_3)_2 \cdot 4\text{H}_2\text{O}$	66	56	51	46	
" sulfate, $\text{CaSO}_4 \cdot 5\text{H}_2\text{O}$	—	98	—	—	
Cobalt chloride, $\text{CoCl}_2 \cdot 6\text{H}_2\text{O}$	72.5(d)	67.3	61.9	56.6	49 at 55°
Copper nitrate, $\text{Cu}(\text{NO}_3)_2$	—	75(d)			
Hexose, $\text{C}_6\text{H}_{12}\text{O}_6 \cdot 1/2\text{H}_2\text{O}$	57(b)	56(f)	55(i)		
Lead nitrate, $\text{Pb}(\text{NO}_3)_2$	99	98	96.5	95.5	88.4 at 103.5°
Magnesium chloride, $\text{MgCl}_2 \cdot 6\text{H}_2\text{O}$	34.7	33.1	31.7	31.3	28 at 71°
" nitrate, $\text{Mg}(\text{NO}_3)_2 \cdot 6\text{H}_2\text{O}$	56(e)				
Mercuric Fulminate, $\text{Hg}(\text{ONC})_2$	99.9(b)				
Oxalic acid, $\text{H}_2\text{C}_2\text{O}_4 \cdot 2\text{H}_2\text{O}$	—	76.0			
Potassium chlorate, KClO_3	—	98.0(h)			
" chloride, KCl	87.4	86.3	84.5	82.8	74.7 at 100°
" chromate, K_2CrO_4	—	88	—	—	
" dichromate, $\text{K}_2\text{Cr}_2\text{O}_7$	—	97.8	—	—	
" nitrate, KNO_3	95.1	94.2	92.5	89.4	61.2 at 110°
" perchlorate, KClO_4	99.8(c)				
" sodium tartrate, $\text{KNaC}_4\text{H}_4\text{O}_6 \cdot 4\text{H}_2\text{O}$	87.5	—	87.1	86	
" sulfate, K_2SO_4	98.2	97.1	96.6	96.1	93 at 102.1°
" sulfocyanate, KCNS	—	47.0	—	—	
" tartrate, $\text{K}_2\text{C}_4\text{H}_4\text{O}_6 \cdot 1/2\text{H}_2\text{O}$	—	75(c)	—	73	
Sodium chlorate, NaClO_3	98.8(b)	—	—	—	
" chloride, NaCl	76.9	75.8	75.1	74.4	73.7 at 100°
" dichromate, $\text{Na}_2\text{Cr}_2\text{O}_7$	—	52	—	—	
" nitrate, NaNO_3	77.7	77.5	73.2	70.5	62 at 71°
" sulfate, Na_2SO_4	93(j)	—	—	—	
" tartrate, $\text{Na}_2\text{C}_4\text{H}_4\text{O}_6 \cdot \text{H}_2\text{O}$	—	92.5	91.1	90.7	
Strontium nitrate, $\text{Sr}(\text{NO}_3)_2$	—	86	—	—	
Sugar, $\text{C}_{12}\text{H}_{22}\text{O}_{11}$	—	85.0(h)	—	—	
Urea, $\text{NH}_2 \cdot \text{CO} \cdot \text{NH}_2$	81.5	80.5	73.3	68.7	62.7 at 50°
Zinc chloride, $\text{ZnCl}_2 \cdot x\text{H}_2\text{O}$	10.0(b)	—	—	—	
" nitrate, $\text{Zn}(\text{NO}_3)_2 \cdot 6\text{H}_2\text{O}$	—	42.0	—	—	
" sulfate, $\text{ZnSO}_4 \cdot 7\text{H}_2\text{O}$	94.7(a)	90	88.5(h)	84	

a - at 5° *f* - at 20°
b - at 12° *g* - at 24.5°
c - at 15° *h* - at 25°
d - at 18° *i* - at 35°
e - at 18.5° *j* - at room temp

70
Do 1/30

until equilibrium is established. Such evaporation can produce caking. Obviously caking will be strongly influenced by the original moisture content of the material

The foregoing table (taken from Ref 1) gives CRH for some explosives and ingredients of explosive and pyrotechnic compositions - *enclosed* *see* *1/30*

Practical measures for controlling explosive dusts by humidification are discussed in Ref 3

Ignition lag times of pyrophoric substances such as $\text{Al}(\text{BH}_4)_3$, AlMe_3 , BEt_3 , etc were found to increase (except for BEt_3) with decreasing humidity. In fact, $\text{Al}(\text{BH}_4)_3$ is not pyrophoric in dry air (Ref 4)

Suppression of firedamp and coal dust explosions, in high humidity coal mines, by stone dusting is affected by humidity. Agglomeration of moisture content of the dusting material influenced its effectiveness as explosion suppressor. Salt dusts become ineffective above 80% relative humidity because they dissolve (Ref 7)

Refs: 1) Gmelin (8th Ed, 1936) p 122 2) Unit Operations Rev "Absorption and Humidification" IEC (1947-1960) 3) H. R. Brown, Safety Engineer **94** 14, 32 (1947) & CA **41**, 7119 (1947) 4) M. Guinet, Rech Aeronaut (Paris) **76**, 25 (1960) & CA **54**, 25826 (1960) 5) F. A. Holland, BritChemEng **9**, 678 (1964) & CA **61**, 15691 (1964) 6) E. J. Amdur (Ed) "Humidity and Moisture: Control in Science and Industry," Reinhold, NY (1965) & CA **63**, 1501 (1965) 7) A. K. Ghosh & M. L. Mahato, JMineMetals Fuels **14** (11) 351 (1967)

Hummel (Bumble Bee). Nickname for a self-propelled mount consisting of 150mm Medium Howitzer on the chassis of a PzKpfw III/IV tank. (See also under Panzer)

Ref: PATR **2510** (1958), p Ger 93-L

Humus. Decayed products of plant life, such as leafmolds, rotten wood, rotten straw, etc. It has been used as an ingredient of some explosive mixtures, as for instance of Bracket Sporting powder, manufactured in the USA, and which contained 18.9% of humus, according to the analysis by Munroe

Ref: Daniel (1902) 82

Hungarian Ammunition, Explosives and Weapons. We have no information on post WWII Hungarian ammunition, expls & weapons

Hunting Powders. See Sporting Powders

Hurst. Patented in 1898 in the USA. The use of NG in frozen form as bursting charge for projectiles

Ref: Daniel (1902) 379

Hybalines. A family of novel metal hydride coordination compds, both liq & solid, trade name of Union Carbide Corp, New York. The company's R & D program at its South Charleston, West Virginia technical center suggests Hybalines may find use as high-energy liq fuels and as additives in high-energy solid proplnts

Carbide is proposing a new concept of solid proplnt grain construction. The process uses std ingredients, yet the grain burns more efficiently and can be fabricated faster than with conventional methods. There also exists a group of binders trademarked *Carbitron* which may find use in solid proplnts because of their superior physical & ballistic props
Refs: 1) Staff, C&EN **40** (26), p 24 (25 June 1962) 2) Staff, "Physical & Chemical Studies of Hybaline A5 Fuel," Progress Rept No 2, RTD-TDR-63-1021, Air Force Systems Command, Res & Technology Div (March 1963) (Conf, not used as a source of info)

Hybrid Rocket Propellants. A special proplnt combination of unlike materials, particularly of unlike physical characteristics. Typical hybrid proplnt combinations are a solid fuel (or oxidizer) in combination with a liquid oxidizer (or fuel) in that order. Sometimes a grain of solid fuel is encased in the combustion chamber of a rocket engine and burned in combination with liq oxygen. Similarly, a liq fuel may be injected into a combustion chamber in contact with a solid oxidizer. Another example is the use of concentrated hydrogen peroxide and a hydrocarbon fuel. In this case, the hydrogen peroxide is converted by decompn into a hot gas contg oxygen. The fuel is injected downstream of the first reaction, mixed with the hot oxidizer-rich gas, and burns (Ref 1)

Hybrid rocket proplnts & hybrid technology provide a number of propulsion-system capabilities in combinations not readily achievable with all-solid or all-liq systems. Foremost among

capabilities are throttling, safety, smokelessness, and low development cost (Ref 7)

Refs: 1) Rocket Encycl (1959), p 209 2) North American Aviation Inc, Rocketdyne Div, "Research in Hybrid Combustion," Summary Rept R-3446 (Dec 1960 thru Nov 1961) [Contract Nonr 3016(00)] 3) Hybrid Propulsion Systems Symposium. Presentations held at Washington, DC (4-5 October 1961). Sponsored by the Bureau of Naval Weapons. Published by the Liquid Propellant Information Agency, Applied Physics Laboratory (Conf) 4) Thiokol Chemical Corp, Reaction Motors Div, "Study of Reverse Hybrid Propulsion System," Rept RMD 5021, QTSR-1 (Oct to Dec 1962) [Contract N600(19)-59314] (Conf) 5) North American Aviation Inc, Rocketdyne Div, "Research in Hybrid Combustion," Final Rept R-5179 (Dec 1961 thru Jan 1963). [Contract 3016(00)] 6) United Aircraft Corp, United Technology Center, "Investigation of Fundamental Phenomena in Hybrid Propulsion," Rept UTC-2007-QT7 (Dec 1962 thru Feb 1963) (Contract NOW 61-1000-c) 7) D. D. Ordahl, 57 (318), 448-49 (1973) (Hybrid Rocket Proplnts)

Hydantoin and Derivatives

Hydantoin, Glycolylurea or Imidazoledione (called Lactam der Ureido-essigsäure in Ger), $\text{HN}\cdot\text{CH}_2\cdot\text{CO}\cdot\text{NH}\cdot\text{CO}$; mw 100.08, N 27.99%; colorless, odorless crystals, sp gr $\frac{3}{4}$, mp 220–21°, bp ?; sol in hot w & alk; sl sol in alc; nearly insol in eth. Was first prepd by Franchimont & Klobbie (Refs 1 & 2). Wagner & Simmons (Ref 3) prepd it by two-step process from glycine, $\text{H}_2\text{N}\cdot\text{CH}_2\cdot\text{H}$. Used as intermediate in manuf of pharmaceuticals, synthetic resins, lubricants, etc. Gives on nitration an expl

Refs: 1) Beil 24, 242, (287) & [127] 2) A.P.N. Franchimont & E.A. Klobbie, Rec 7, 12 (1888) 3) E.C. Wagner & J.K. Simons, JChemEducn 13, 266 (1936) 4) CondChem-Dict (1961), 582-R (Hydantoin); (1971), 450-L **N-Nitrohydantoin or N-Nitroglycolylurea**, $\text{O}_2\text{N}\cdot\text{N}\cdot\text{CH}_2\cdot\text{CO}\cdot\text{NH}\cdot\text{CO}$; mw 145.08, N 28.96%, OB to CO_2 -38.6%; colorless, sl hygroscopic plates; sp gr ?, mp 170–71° (dec), bp—puffs off and sometimes ignites at 225°, but does not explode. Dissolves in w giving an acidic soln

(pH 5). Can be prepd either by nitrating hydantoin with mixed nitric-acetic acid or by dissolving hydantoin (15g) in white nitric (50ml), followed by evaporation of the soln to dryness on a steam bath

It is a mild expl of satisfactory thermal stability and with sensitivity to impact comparable to that of TNT. Its heat of combstn is 295kcal/mol

Refs: 1) Beil 24, 259 2) A.P.N. Franchimont & E.A. Klobbie, Rec 7, 236 (1888) 3) E.C. Wanger & J.K. Simons, JChemEducn 13, 266 (1936) 4) R.Adams & C.S. Marvel, OSRD 86 (1941), pp 1, 7–8 & 20–22 No Azido- or Polynitro-derivs of Hydantoin are found in Beil or CA thru 1971

Hydral-cellulose, $(\text{C}_6\text{H}_{10}\text{O}_5)_4\cdot\text{H}_2\text{O}$, mw 666.58. May be prepd by digesting cellulose, such as filter paper, with a solution of H_2O_2 until completely disintegrated. On evaporation, a white substance is obtained which resembles "oxycellulose" in its properties. When treated with 10% aqueous NaOH, 33% of it dissolves, leaving a residue resembling cellulose

When cellulose is treated with concentrated H_2O_2 (60%) the resulting mixture is explosive (see Hydrogen Peroxide Explosives)

Refs: 1) Marshall 1 (1917), 154 2) A.W. Schorger, "The Chemistry of Cellulose and Wood", McGraw-Hill (1926), pp 269, 270 & 276 3) Marsh & Wood, Cellulose (1945), 253

Hydra Programs. HYDRA is a US Navy code name for all its studies & tests of sea-launched missile concepts & systems. To simulate nuclear explns, Hydra programs have used chem HES (Pentolite) which form noncondensable gas bubbles. In an effort to more accurately simulate nuclear detonations, which form steam bubbles, two steam producing expls were developed. These were an equal mixt by wt of RDX & alum [$\text{AlNH}_4(\text{SO}_4)_2\cdot 12\text{H}_2\text{O}$] and a pressurized stoichiometric mixt of hydrogen & oxygen. Using Friedman's formula for the bubble oscillation period and the experimentally determined bubble periods from Hydra studies, the energy partition (ie, fraction of chge energy left for bubble oscillation after shock passage) of the three expls were found to be:

Explosive	r
Pentolite	0.45±0.12
RDX + alum	0.50±0.14
2H ₂ + O ₂	0.41±0.11

Since the min error variation in energy partition is much greater than the variation due to type of expl, it makes little difference which expl is used to simulate the nuclear case (Ref 6)

See also Refs 1, 2, 3, 4, 5 & 7 for further details

Refs: 1) W.G. Neall, "Radiological Safety Report. Hydra 1 at David Taylor Model Basin, Washington, DC," Naval Radiological Defense Lab Rept **USNRDL-TR-423** (May 1960) 2) J. W. Hendricks & D.L. Smith, "Above-and-Below-Surface Effects of One-Pound Underwater Explosions Hydra 1," Ibid, **USNRDL-TR-480** (Oct 1960) 3) J. S. Hedge, "Hydra Program, Determination of the Total Thermal Radiant Energy Emitted by an Underwater Exploding Wire," **USNRDL-TR-612** (Jan 1963) 4) R. R. Buntzen, "Hydra Program. The NRDL Low-Yield Underwater Explosion Tank and Associated Instrumentation," **USNRDL-TR-623** (Feb 1963) 5) K. W. Kaulum, "Hydra Program—Hydra IIB Series—Investigation by Water Sampling of the Internal Structure of Columns Resulting from Small Shallow Underwater Explosions," Ibid, **USNRDL-TR-706** (Sept 1963) 6) M. Kaltwasser, "Hydra Program—Theoretical and Experimental Determination of Energy Partition of Selected Underwater Explosives," **USNRDL-TR-702** (Oct 1963) 7) W. W. Perkins, "Hydra Program. Hydra IIA Series—The Above-Surface Phenomena Created by 10000-Pound Underwater Detonations," **DASA-1443** (Oct 1963) (Conf) (Not used as a source of info)

Hydrated Cellulose, C₁₂H₂₀O₁₀·H₂O, mw 342.30; name proposed by Cross and Bevan for substances recovered from cellulose that has been mercerized (by treatment with aqueous NaOH) and then washed out, or that which has been converted into viscose and then regenerated

The name "hydrated cellulose" is now considered to be obsolete, and the term "dispersed" cellulose has become more general (Refs 1 & 2). Hydrated cellulose gives off 1 mol of water at 120-125° while hydrocellulose retains it obstinately (Ref 2). See also Amyloid in Vol 1, p A398-L

Refs: 1) Marshall 1 (1917), pp 153-54
2) Marsh & Wood, Cellulose (1945), p 152

Hydrated Explosives. Permissible explosives (ie permissible for use in gassy mines) in which salts containing water of crystallization, such as MgSO₄·7H₂O with 51.22% H₂O, K₂Al₂(SO₄)₄·24H₂O with 45.57% H₂O, Al₂(SO₄)₃·18H₂O with 48.81% H₂O, CaSO₄·2H₂O with 20.92% H₂O etc, are characteristic ingredients. Explosives of this class are somewhat similar in composition to the ordinary low-grade Dynamites (all of which contain NG as the principle explosive ingredient and many contain Ammonium Nitrate), except that one or more salts containing water of crystallization are added to reduce flame temperature. These explosives are usually easily detonated, produce only small quantities of poisonous gases and generally can be used successfully in damp working places. A typical hydrated explosive has the following composition: NG42, hydrated Mg or Na sulfate 46, wood-meal 12%. Its strength compared to blasting gelatin: 200ml lead block expansion and 11mm crushing compared to 560cc and 24mm for 92/8 blasting gelatin

See also Permissible Dynamites in Vol 5, p D1604-Rff

Refs: 1) C. Hall & S. Howell, "Tests of Permissible Explosives," USBur of Mines Bull **66**, Washington (1913), p 19 2) C. G. Storm, Analysis of Permissible Explosives, US Bur of M Bull **96**, Washington (1916), pp 5,6 3) Marshall 2 (1917), 605 4) Naoúm, NG (1928), 399

Hydraulic Coal Bursters are devices using compressed water for breaking down the coal. Some of these devices are described in the book of J. Taylor and P.F. Gay, "British Coal Mining Explosives", G. Newnes Ltd, London (1958), pp 134-137

Hydrazide is a deriv of Hydrazine (qv) of general formula MHN.NH₂, where M means metal. One such compd, *Sodium Hydrazide*, NaHN.NH₂, mw 54.04, N 51.85%, is extremely explosive. It can be prep'd by the action of Na on anhydrous hydrazine or from NaNH₂ and hydrazine
Refs: 1) Gmelins Handbuch, 8th ed (1936), Syst 23, p 537 2) C.C. Clark, "Hydrazine", Mathieson Chem Corp, Baltimore, Md (1953), p 4

Hydrazides are compounds of the type RCONHNH₂. It is claimed that during recovery of pure anhydrous hydrazine from its mixtures with NH₄Cl & NH₃, by treating the mixture with a stoichiometric excess of alkali or alkaline earth metals in dil liq ammonia, a large excess of the metal is to be avoided to prevent formation of explosive hydrazides

Refs: 1) F. T. Neth USP 2,735,752 (1956) & CA 50 8148 (1958) 2) No further refs to explosive hydrazides was found in CA 1957-71

Hydrazidicarboxylic Acid, Mercuric Ester.

C₆H₁₀O₄N₂Hg; this powder is claimed to explode on heating (total abstract)

Ref: R. Stollé, Ber 45, 273 (1912) & CA 6, 1005 (1912)

Hydrazidioxalic Acid—Diazide(called Hydrazidioxalsäure—diazid in Ger) N₃COCONHNHCOCON₃, mw 226.12, N 49.56%, OB -35.4; wh powd (from eth). Prepd by treating hydrazidioxalic acid-dihydrazide with nitric acid. Explodes on heating

Ref: Beil 2, (244)

Hydrazinate of Diammoniodecaborane or

Diammoniodecaborane (1,2) hydrazinate.

NH₃(B₁₀H₁₂)NH₃·N₂H₄; was prepd (Ref 1) by adding hydrazine to a suspension of B₁₀H₁₂·2MeCN in benzene and refluxing the mixt. The benzene layer was decanted, the N₂H₄ layer was heated, EtOH was added & the mixt was cooled to 0° to ppt the salt. A suggested use is as a propellant component. No properties given
Ref: M.F. Hawthorne & A.R. Pitochelli, USP 3453092 (1969) & CA 71, 103742p (1969)

HYDRAZINE, ITS SALTS AND DERIVATIVES

Hydrazine, Anhydrous (Diamidogen or Diamide), H₂N.NH₂; mw 32.05, N 87.43%, OB to CO₂ -100%; colorless, corrosive, fuming hygroscopic liquid; sp gr 1.011 at 15°/4° (Lange) or 1.004 at 25°/4° (Ref 18a); fr p 2.0°, bp 113.5°, fl p (open cup) 126°F; RefrIndex 1.46979 at 22.3°. Vapor pressure can be calcd by the equation given in Ref 11; viscosity by the eqn given in Ref 8, thermodynamic data is in Ref 12, heat capacity of liquid is in Ref 2, heat capacity of gas is in Ref 11 and entropy is in Ref 11. Heat

of combustion to water liq is 148.635kcal/mole (Ref 9). Sol in polar liquids such as water, alcohol, ammonia & amines; insol in nonpolar liquids such as ether, chl_f, hydrocarbons and halogenated hydrocarbons. It is strong reducing agent and diacid base. Its vapor is explosive and toxic and especially dangerous to the eye (Refs 18a, 27c and 32a) (See also under Toxicity)

Preparation.

Anhydrous hydrazine was first prepd in 1894 by Lobry de Bruyn, but its salts and derivs were prepd beginning in 1875 by Emil Fischer, who coined the name "hydrazin". The "hydrazine hydrate" was first prepd by Th. Curtius in 1887 (Ref 14a, p 1)

Accdg to Clark (Ref 14a), only a small scale operation was producing hydrazine prior to WWII

In WWII the Germans discovered that N₂H₄ was an excellent rocket fuel when used with hydrogen peroxide, oxygen or fuming nitric acid. They used hydrazine as the propellant of their first rocket plane

The synthesis developed in 1907 by Raschig is the only preparative method that is now used commercially to produce N₂H₄ (Refs 3, 4 & 5). Sodium hypochlorite and NH₃ are first reacted to form chloramine according to:

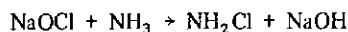

Then hydrazine is formed by the action of excess ammonia upon chloramine:

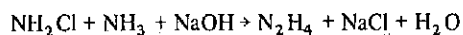

The Raschig synthesis yields a crude solution containing about 2% N₂H₄. After evaporating to precipitate sodium chloride, the purified hydrazine hydrate solution is distilled to yield an azeotrope containing 58.5 mole% N₂H₄. Commercial anhydrous hydrazine is produced by an azeotropic distillation using aniline process (Ref 18). In the US, Mathieson Chem Co began in 1947 research on the production of anhyd hydrazine with emphasis directed to its use as a rocket fuel. After constructing a pilot plant, an installation for commercial production of hydrazine and its derivs was erected at Lake Charles, Louisiana

A modification of the Raschig synthesis uses urea in place of ammonia to synthesize N₂H₄ according to (Ref 12):

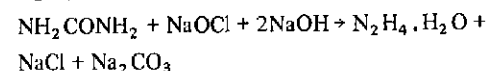

ended near 2/1/99

Audrieth summarizes many other lab prep methods based upon hyponitrous acid ($H_2N_2O_2$), nitramide (NH_2NO_2), nitrosohydroxylamine [$NH(NO)OH$] derivatives, nitrosoamine (NH_2NO) derivatives, nitrosoketones, azo compounds, hydrazoic acid and azides, nitrogen and the decomposition of NH_3 (Ref 12). In more recent work Anderson converted NH_3 to N_2H_4 by passing NH_3 through a discharge tube using high frequency radio waves (Ref 17). Yields in terms of energy input are discouragingly low. Aerojet General has also studied a process based upon thermal decomposition of NH_3 in a nuclear reactor but without achieving commercial production (Ref 26)

Accdg to Ref 38, although the classical Raschig Process was improved by West Germany's Bayer, many of its drawbacks still exist. These include the environmental problem of disposing of the large quantity of by-product chloride, the current tight chlorine situation and sizable consumption of primary energy

Now chemists at the Central Research Laboratories of Produits Chimiques Ugine Kuhlmann (PCUK) at Lyons, France, developed beginning in 1970, under the direction of Dr F. Weiss, a novel continuous process for manufg hydrazine. The process is based on the discovery that ammonia, hydrogen peroxide, and a carbonyl compd, such as methyl ethyl ketone, react in presence of an amide and catalytic quantities of a phosphate to form an azine intermediate. This intermediate hydrolyzes quantitatively to hydrazine and to carbonyl compd which is recycled. The yield is claimed to be better than 75%

The reaction proceeds as follows:

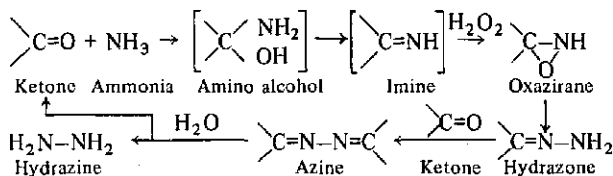

Accdg to PCUK's Dr J.P. Schirmann, the new method in addn to having a decided economic edge over existing methods, has the important advantage that chlorine compds are not involved in the reaction

Encouraged by the operating success so far of a pilot plant in Lyons, PCUK is building a small-scale commercial unit there due on stream in 1975. A full scale plant is planned for 1977

Hydrazine demand is rising continuously. Apart from being a constituent of rocket fuels, it is used to remove oxygen from boiler water to prevent the corrosion of the vessels. If, as some believe, hydrazine-based fuel cells eventually come into commercial use, demand will be enormous. Hydrazine hydrate production in non-communist countries now stands at about 25000 metric tons per year, of which 17000 metric tons are used by the US with about 7000 metric tons taken by the space programs. US hydrazine capacity will be greatly increased by the end of 1975 when Mobay's 10000mt/yr unit constructed at Baytown, Texas will be ready

The reaction of the PCUK process is described more fully by Dr Schirmann on p 19-L of Ref 38, while the additional advantages of the process are listed by Dr S. Delavarenne on p 19-M

Toxicology

If spilled on the skin or in the eyes liquid N_2H_4 can cause severe local damage or burns and can cause dermatitis. In addition it can penetrate skin to cause systemic effects similar to those produced when the compound is swallowed or inhaled. Inhalation of the vapor causes local irritation of the respiratory tract and eyes. On short exposure systemic effects involve the central nervous system. Resultant symptoms include tremors & on exposure to higher concentrations, convulsions and possibly death follow. Repeated exposures may cause toxic damage to the liver (fatty liver) and kidney (interstitial nephritis), as well as anemia. The threshold limit value of hydrazine is 1 ppm (1.3 mg/m^3) (Ref 20) (See also Refs 27c and 33a)

Uses

The use of N_2H_4 as a hypergolic propellant fuel for rocket propulsion is discussed in detail in this Vol under *Hypergolic Propellants*. It has also been used extensively as a monopropellant fuel or in combination with hydrazine nitrate and/or water as a thruster for maneuvering space vehicles (Ref 31)

Applications using hydrazine as a gas generator include tank pressurization, inflating pneumatic-power engine starters, turbines and positive displacement drives. The development of many of these uses was brought about by the introduction of decomposition catalysts discussed below in the section on combustion properties

Hydrazine is used for the preparation of hydrazoic acid according to:

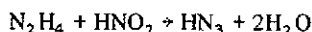

or for the preparation of sodium azide (Ref 14). Hydrazine is used also as a scavenger for oxygen in preventing corrosion in boilers (Ref 16) and as an oxygen scavenger to prevent external corrosion of oilwell casings (Ref 21). It has been found to be an excellent fuel for fuel cells (Refs 23, 25 & 27). Hydrazine is also used in a family of liquid expls developed & marketed under the trade name "Astrolite" by the Explosive Corporation of America, Issaquah, Wash (Refs 27b, 33a & 37)

Analytical

The water and ammonia content of anhydrous N_2H_4 are determined by a gas chromatography (Refs 37 & 38) method, and the analysis of the aniline in the mixture by ultraviolet spectroscopy. The total N_2H_4 content can be then determined by difference. Other methods are given at the end of section on Hydrazine

Chemistry

N_2H_4 has been characterized by Audrieth (Ref 7) as a saturated hydronitrogen belonging to the type given by the formula N_nH_{n+2} . The members of this series of compounds are as follows:

NH_3 ammonia	NH_3
N_2H_4 hydrazine	$\text{H}_2\text{N}-\text{NH}_2$
N_3H_5 triazane	$\text{H}_2\text{N}-\underset{\text{H}}{\text{N}}-\text{NH}_2$
N_4H_6 tetrazane	$\text{H}_2-\text{N}-\underset{\text{H}}{\overset{\text{H}}{\text{N}}}-\text{N}-\text{NH}_2$

Hydrazine may be looked upon as the nitrogen analog of hydrogen peroxide. It is a powerful reducing agent which makes it an attractive fuel for reaction with oxidizers such as H_2O_2 , O_2 , and fuming nitric acids and nitrogen tetroxide. Aqueous solutions of N_2H_4 have been employed to reduce various metallic ions such as copper, silver, gold and the platinum metals to the metallic state. It also reduces strong oxidizing agents such as permanganate, iodate, hypoiodate, iodine, cerate and the like. Many of these reactions have been used for the quantitative determination of hydrazine but side reactions giving off NH_3 and in some instances hydrazoic acid may present problems

Anhydrous N_2H_4 is a thermodynamically unstable compound and tends to undergo decomposition to N_2 , H_2 and NH_3 spontaneously. This is also true in aqueous solutions and is enhanced by the presence of catalytically active metals and oxides, such as Cu, Zn, Fe_2O_3 etc (Ref 7)

Generally hydrazine reactions are similar to those of ammonia and amines except that as a diamine, further reaction takes place. The reaction of N_2H_4 with CO at 20-50°C and high pressure produces semicarbazide (Ref 1). At higher temperatures and pressures the products are 4-amino-1,2,4-triazol-3-one and 4-amino-1,2,4-triazole. With cyanamide, hydrazine forms aminoguanidine which is treated with nitrous acid to form tetracene, a primary explosive (Ref 15, 19). Carboxylic acids are neutralized by hydrazine to form salts which decompose upon heating to give mono- or diacylohydrazides (Ref 2). The hydrazine salts of oxidizing acids, such as nitric acid or perchloric acid, are sensitive to shock and decompose violently. Hydrazinium Selenate, $\text{N}_2\text{H}_5\text{HSeO}_4$, is also explosive, in fact a very sensitive explosive (Ref 27a). Salts of very powerful oxidizing acids (eg chromic or permanganic) are unknown and are unlikely to exist. Hydrazonium iodate may exist in solution at low temp (Ref 27a). Alkali metals, amides and hydrides react with hydrazine to give the corresponding alkali hydrazide. Sodium hydrazide explodes violently in the presence of O_2 or when heated above 100°C—a typical behavior of the alkali hydrazides. For other reactions, see Ref 24

Explosive and Combustion Properties

Liquid anhydrous N_2H_4 is a non-explosive even though it is thermodynamically unstable. In the absence of decomposition catalysts, it has been heated above 500°F with very little decomposition. It is completely insensitive to shock, friction or electrical discharge. Hydrazine vapor has a lower limit of inflammability of 4.67% by volume in air. The upper limit is 100% since the vapor may be exploded without the addition of air (Ref 10)

The use of N_2H_4 as a hypergolic rocket fuel is described under the topic *Hypergolic Propellants* in this Vol. Another major research effort has seen the development of hydrazine thruster rockets based upon the catalytic de-

composition of hydrazine. Typical thruster rockets give thrusts ranging from 0.1 ft-lb to 5 ft-lb with positive thrust pulses ranging to 1 million cycles (Refs 13 & 35). Catalysts studied for the heterogeneous decomposition of N_2H_4 include ruthenium, iridium and rhodium. Decomposition kinetics are detailed for ruthenium (Ref 34) and rhodium (Ref 36)

Due to the relatively high freezing point of pure anhydrous N_2H_4 , simple binary and ternary solutions of N_2H_4 with water, ammonia and hydrazine nitrate form low freezing eutectics which provide a wide range of exhaust gas temperatures and compositions when used in gas generators. Typical examples are given in Ref 31. Ternary diagrams for the system $N_2H_4-N_2H_5NO_3-H_2O$ give mixture freezing points, detonable limits and vacuum specific impulse for 20%, 40% and 60% NH_3 in the equilibrium mixture

Explosive Compositions

Mixtures of hydrazine and other compounds form liquid explosives which have been described. A study of the detonability of binary and ternary mixtures of nitromethane-hydrazine-methanol showed that N_2H_4 sensitizes nitromethane and nitromethane-methanol mixtures to detonation (Ref 29). From 2-10% N_2H_4 and 90-98% lower molecular weight nitroparaffins are claimed to be a water insoluble liquid explosive (Ref 22). Mixtures of hydrazine, ammonium nitrate and aluminum have been patented as explosive compositions with high air blast effects (Ref 32). High performance explosive mixtures with densities ≥ 1.4 have been obtained with a sensitizer containing an oxidizing acid and a base such as hydrazine (Ref 30). High detonation rate, low freezing point, low viscosity and low impact sensitivity are provided by mixture of $N_2H_5NO_3$ (and its mixtures with $N_2H_5-ClO_4$ in a 4:1 ratio for increased sensitivity) and including up to 25% of metal salts such as Na, K, Ca and Al nitrates and perchlorates, 6-15% N_2H_4 and 2-15% NH_3 and water (Ref 28). The water content is varied to control the detonation velocity. For example a solution containing $N_2H_5NO_3$ 70%, N_2H_4 7% and NH_3 14% has a density of 1.31, detonation rate 8100 m/sec, fp $-8^\circ F$ and a viscosity of 12 cp. Variable amounts of perchlorates give impact sensitivities of 45-85 Kg/cm (nitroglycerin = 2 Kg/cm on the particular impact machine used)

Hydrazine forms numerous salts and derivatives, some of which are expl or used as ingredients of expls or for their prepn. Several of them are described below

Refs: 1) V. Meyer & M.T. Lecco, *ChemBer* **16**, 2976 (1883) 2) Th. Curtius & H. Franzen, *ChemBer* **35**, 3239 (1902) 3) F. Raschig, *ZAngewChem* **20**, 2065-2067 (1907) 4) F. Raschig, *ChemZtg* **31**, 926 (1907) 5) F. Raschig, *Schwefel- und Steckstoffstudien*, Verlag Chemie GmbH, Leipzig, Berlin (1924) 6) International Critical Tables, McGraw-Hill, NY (1928), 1st Ed, vol **3**, pp 228-229 7) L.F. Audrieth, *JChemEducation* **7**, 2055-2062 (1930) 8) P. Walden & H. Hilgert, *ZPhysikChem* **165A**, 241-271 (1933) 8a) "Gmelins Handbuch der anorganischen Chemie", 8th Edn, Verlag Chemie, Berlin (1936), Syst 4, pp 315-16 and Syst 23, p 547-48 9) A.M. Hugher et al, *JAmChemSoc* **61**, 2639-2642 (1939) 10) F.E. Scott et al, "Explosive Properties of Hydrazine", RI 4460, Bureau of Mines, (May 1949) 11) D.W. Scott et al, *JACS* **71**, 2293-2297 (1949) 12) L.F. Audrieth & Betty A. Ogg, "The Chemistry of Hydrazine", John Wiley & Sons, NY (1951), pp 99ff 12a) E.F. Wiebke, *AnalChem* **23**, No 6, 922 (1951) & *CA* **45**, 7469 (1951) 13) B.W. Schmitz & W.W. Wilson, "Long Life Monopropellant Hydrazine Engine Development Program, Final Rept," Rocket Research, RRC-71-R-257 (Sept 1951) (Available NTIS-AD-731287) 14) Ullmann, **6**, 206, *Encyklopädie der Technischen Chemie* (1951) 14a) Ch.C. Clark, "Hydrazine", Mathieson Chem Corp, Baltimore, Md (1952), pp 1-3, 19-29, 83-4 & 92-113 (Numerous references) 15) S.H. Patenkin et al, *JAmChemSoc* **77**, 562 (1955) 16) Anon, "Hydrazine and Water Treatment," Whiffen & Sons, Ltd, London (1958) 17) W. H. Anderson et al, *IEC* **51**, 527 (1959) & *CA* **53**, 14432 (1959) 18) B.H. Nicolaisen et al, "Commercial Production of Hydrazine," K.A. Kobe & J.J. McKetter, Jr, eds; *Advances In Petroleum Chemistry & Refining*, vol 2, Interscience Publishers, Inc, NY (1959), chap 9 18a) *CondChemDict* (1961), p 584-L 19) F. Kurzer & L.E.A. Godfrey, *ChemInd*, London (1962) 1584 20) Anon, The Handling & Storage of Liquid Propellants, Office of the Director of Defense Research & Engineering, Wash, DC (Jan 1963) 20a) D.M. Kuwada, *JGenChem* (March 1963) p 11 & *CA* **59**, 3320

- (1963) 21) F.W. Schremp, *OilGasJ* **61** (25), 96 (1963) & *CA* **59**, 9076 (1963) 22) Aerojet General Corp (no author), BelgP 627768 & *CA* **60**, 13091 (1963) 23) S.S. Tomter & A.P. Anthony, "The Hydrazine Fuel Cell System," in "Fuel Cells," HICHE, NY (1963) pp 22-31 24) Th. Kauffmann, *AngewChemIntern Ed (Engl)* **3**, 342 (1964); *AngewChem* **76**, 206 (1964) & *CA* **60**, 10489 (1964) 25) R.J. Jasinski & T.G. Kirkland, *MechEng* **86**, (3), 51 (1964) & *CA* **60**, 14117 (1964) 26) J.H. Cusack et al, "Continuously Circulating Fission-chemical Process Development Applicable to Hydrazine Synthesis, vol I—Program Survey, Processing & Materials," AFML-TR-65-98, Final Rept (Jan 1965) Aerojet General Nucleonics, San Ramon, Ca, Available DDC 27) R. Jasinski, *ElectrochemTechnol* **3** (1965) 129 & *CA* **64**, 6084g (1966) 27a) A.A. Shidlovskii, *ZhFizKhim* **39** (9), 2163 (1965) & *CA* **64**, 516 (1966) 27b) S. Levmore & S.J. Lowell, "Principal Characteristics of the Liquid Explosive Astrolite G", PATR **3633** (Aug 1967) 27c) Sax (1968), p 819-R 28) M. Maes, USP 3419443 & *CA* **70**, 69763 (1969) 29) D.R. Forshey et al, "Detonability of the Nitromethane-Hydrazine-Methanol System", *Explosivstoffe* (1969), 17 (6), 125-9 & *CA* **71**, 103735 (1969) 30) C. Dinglison & W. Lysterly, USP 3431155 & *CA* **70**, 116778 (1969) 31) Anon, Monopropellant Hydrazine Design Data, Rocket Research Corp, Seattle, Wash (1969) 32) R.M. Bridgforth et al, USP 3523047 & *CA* **74**, 14701 (1971) 33) *Cond-ChemDict* (1971), p 551-L 33a) Staff, Biogenetics Res Labs, Bethesda, Md, "Acute Toxicology Studies on Astrolite A-1-5", Rept submitted to Explosives Corporation of America (Feb 1971) 34) C.F. Sayer, "The Heterogeneous Decomposition of Hydrazine, Part 5: The Kinetics of the Decomposition of Liquid Hydrazine on a Supported Ruthenium Catalyst", Rocket Propulsion Establishment, Westcott (England) Rept No RPE-TR-72/1-PT-5; (BR-29320) Available NTIS (N73-14122) (Jan 1972) 35) P.I. Moynihan, "Minimum Impulse Tests of 0.45-N Liquid Hydrazine Catalytic Thrusters," JPL Quarterly Tech Rev, vol 2, No 1 (April 1972) pp 107-112 36) C.F. Sayer, "The Heterogeneous Decomposition of N₂H₄, Part 4: "The Kinetics of the Decomposition of Liquid Hydrazine on a Supported Rhodium Catalyst," Rocket Propulsion Establishment, Westcott (England), Rept No RPE-TR-71/16-PT-4; BR-31012, Available NTIS (N73-19177) (Nov 1972) 37) S. Levmore, "Physical Characteristics of the Gelled Slurry Explosive Astrolite A-1-5", PATR **4650** (May 1974) 38) Staff, "Hydrazine Process Offers Advantages", *C&EN* **52**, No 37, pp 18-19 (16 Sept 1974)
- Hydrazine and Derivatives, Analytical Procedures.**
See at the end of this section
- Hydrazine Azide, Hydrazine Azoimide or Hydrazonium Azide.** See list of *Inorganic Azides* in Vol 1, pp A536-537, and additional information below
- Apin et al (Ref 4), in a calorimetric investigation of mixtures of Hydrazine Azide with several metallic elements found that an explosion resulted with the formation of NH₃. The amount of NH₃ depended on the explosion conditions. The limiting conditions were either N₂H₄·HN₃ → 2½H₂ + 2½N₂ or → 1 2/3NH₃ + 1 2/3N₂
- Calcium Azide Hydrazinates.** Ca(N₃)₂·N₂H₄ and Ca(N₃)₂·2N₂H₄; the addn of alc to a soln of Ca(N₃)₂ in anhyd N₂H₄, or evapn of such a soln in a vacuum desiccator over sulfuric acid leads to the formation of a 2-hydrazinate. This solvate dissociates rapidly under reduced pressure and/or at higher temps to give the 1-hydrazinate, Ca(N₃)₂·N₂H₄ (Ref 1)
Refs: 1) A.L. Dresser & A.N. Brown, *JACS* **53**, 4235 (1931) & *CA* **26**, 666 (1932) 2) A.L. Dresser et al, *JACS* **55**, 1963 (1933) & *CA* **27**, 3417 (1933) 3) L.F. Audrieth & Betty A. Ogg, "The Chemistry of Hydrazine", J. Wiley, NY (1951) 4) A.Ya. Apin et al, *ZhFizKhim* **32**, 819 (1958) & *CA* **52**, 21108 (1958)
- Hydrazine Chlorate, Hydrazinium Chlorate.** N₂H₄·HClO₃ or N₂H₅ClO₃; mw 116.51, N 24.05%, OB to Cl₂ and H₂O +6.9%; crystals; mp 80°; v sol in H₂O, diff sol in alc, insol in ether, benzene and chloroform; hygroscopic; may be prepd by mixing eq solns of N₂H₄ and HClO₃ and evap at room temp; a powerful oxidizing agent and a very powerful explosive. Its power, as detd by Trauzl test is

about 278% of Mercury Fulminate or 100% TNT. It is less stable than Hydrazine Perchlorate. It has been proposed for use in primary and initiating mixtures (Ref 1)

Refs: 1) R. Salvadori, *GazzChimItal* **37** (2), 32 (1907) & *CA* **2**, 182 (1908) 2) Gmelins Hdb (1936), Syst 33, p 555 3) Blatt, *OSRD* **2014** (1944) 4) ADL, *PureExplCompds* (1947), p 72, Compd 140 5) Ullmann **6**, 206 (1951) 6) L. Audrieth & B.A. Ogg, "The Chemistry of Hydrazine", Wiley, NY (1951) 7) Ch.C. Clark, "Hydrazine", Mathieson Chem Corp, Baltimore (1953) p 13

Hydrazine Chlorate and Perchlorate Complexes.
See Hydrazine Perchlorate and Chlorate Complexes

Hydrazine (or Hydrazinium Chloride (or Monochloride) (or Hydrochloride), $N_2H_4 \cdot HCl$; mw 68.52, N 40.89%; colorless crysts, mp 92.6° , decomp at 240° ; v sol in w; diffc sol in absol alc; easily sol in liq NH_3 - Forms a number of double salts. Can be prepd by treating hydrazine hydrate with 1 mole of HCl

Refs: 1) Gmelins Hdb (1936), Syst 23, pp 552-53 2) Clark, *Hydrazine* (1953), p 12 3) Lange (1961), 256 4) *CondChemDict* (1961), 584 (Hydrazine Monochloride; (1971), 451-R

Hydrazine (or Hydrazinium) Chlorite, $N_2H_4 \cdot HClO_2$; mw 100.52, N 27.88%, mp-ignites spontaneously when dry. Was prepd in small amts from hydrazine hydrosulfate ($N_2H_5 \cdot HSO_4$), Ba hydroxide and Ba chlorite [$Ba(ClO_2)_2$]

Refs: 1) Gmelins Hdb (1936), Syst 33, p 555 2) Clark, *Hydrazine* (1953), p 13

Hydrazine (or Hydrazonium)-N,N'-dicarbonic Acid Diazide. See under HYDRAZINE SALTS OF ORGANIC ACIDS

Hydrazine (or Hydrazinium) Dichloride (or Dihydrochloride), $N_2H_4 \cdot 2HCl$, mw 69.53, N 40.30%; wh crysts, sp gr 1.4226 at $20^\circ/4^\circ$, mp 198° with dissociation; detonates on ignition, or when heated rapidly; hygroscopic; v sol in w; almost insol in hot absol alc. Can be prepd from hydrazine hydrate and excess of HCl or from hydrazine hydrosulfate and Ba chloride
Refs: 1) Gmelin's Hdb (1936), Syst 23, p 553

2) Clark, *Hydrazine* (1953), 12-13 3) Lange (1961), 256 4) *CondChemDict* (1971), 451-R

Hydrazine Dihydrochloride. See Hydrazine Dichloride

Hydrazine Dinitrate. See under HYDRAZINE NITRATES

Hydrazine (or Hydrazinium) Hydrate, $NH_2NH_2 \cdot H_2O$; mw 50.06, N 55.97%; exists only in the solid state, contains 64% N_2H_4 , bp 118.5° at 739.5mm (Ref 2a, p 100); fr p $-51.7^\circ C$; density $25^\circ C$ 1.031g/ml; fl p (open cup $163^\circ F$; refractive index 1.4284 at 20° (Ref 4); vapor pressure for the hydrate given in Ref 1. Misc with w & alc; insol in eth & chl_f; strong reducing agent, weak base. Its aq soln was first prepd in 1887 by Th. Curtius. In the Raschig process (prior to 1924), NaOH, chlorine and ammonia react in aq soln to form dil soln of hydrazine, with Na chloride as a by-product; also by oxidation of urea by Na hypochlorite. For its purification can be used: fractional distillation, flash distillation or conversion to the slightly sol sulfate, followed by treatment of the latter with concd NaOH soln. Its vapor is expl and toxic; especially dangerous to the eyes

Analytical. Hydrazine content in aqueous solutions is determined by reacting with picryl chloride to form the yellow hexanitro hydrazobenzene, which, with alkali forms red or violet salts that can be measured colorimetrically (Ref 3). More concentrated solution of hydrazine can be titrated with either standard iodine or iodate solutions according to the following equations (Ref 4):

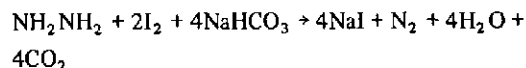

or

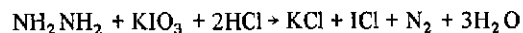

Heat of formation -10.3 kcal/mole; heat of combustion $+146.94$ kcal/mole with water liq (Ref 2a, p 28)

Thermal, Combustion and Explosion Properties. Ign temperatures of 85% hydrazine hydrate in pyrex and air was found to be $292^\circ C$. Oxygen lowered the ignition point to $218^\circ C$. On platinum foil an air atmosphere gave an ignition

temperature of 338°C and oxygen gave 132°C (Ref 1). The hydrate was not found to be sensitive to the impact of a 5kg weight dropped from a height of 1 meter. No explosion, burning or local reaction occurred when the 85% hydrate was subjected to the standard friction sensitivity test in the pendulum-friction machine. No explosion was obtained when hydrazine hydrate was subjected to a detonator in the ballistic mortar. No noticeable decomposition was observed in unconfined samples when a static spark of 12.5 joules was discharged through the liquid (Ref 1)

Used for prepn of anhydrous hydrazine and for the same purposes as listed under Hydrazine, Anhydrous. Also used as gas absorbent (Ref 2a, p 100)

Explosive Compositions. See hydrazine for explosive compositions containing water
Refs: 1) F.E. Scott et al, "Explosive Properties of Hydrazine", Bureau of Mines, RI 4460 (May 1949) 2) L.F. Audrieth & Betty A. Ogg, "The Chemistry of Hydrazine", John Wiley, NY (1951) 2a) Ch.C. Clark, "Hydrazine", Mathieson Chem Corp, Baltimore, Md (1953), pp 2, 8, 28, 100 & 112 3) A.I. Cherkosov & L.M. Kul'berg, ZhurAnalitKhim **11**, 89-90 (1956) & CA **50**, 9236 (1956) 4) Kirk & Othmer, "Encyclopedia of Chemical Technology", **11** (1966), p 166 5) CondChemDict (1971), 451-R

Hydrazine Hydrate and Hydrazine Reactions with Explosive Violence.

The following reactions with inorganic substances are taken from the book of Clark, Hydrazine (1953), pp 4 to 18: Potassium reacts with N_2H_4 expl violently (p 4); Mercuric oxide reacts with $N_2H_4 \cdot H_2O$ with expl violence (p 5); Chlorine, bromine and iodine react violently (p 8) with N_2H_4 and spontaneous ignition of N_2H_4 takes place in a chlorine atm. Explns of N_2H_4 and iodine have been reported (p 12)

In Chap III of Clark's book entitled "Organic Chemistry of Hydrazine", it is stated on pp 83-4, that all indications are that anhydrous hydrazine reacts so vigorously with org substances that products will not be the same as with hydrazine hydrate or the salts. Anhyd N H is not used for making org hydrazides because it attacks other groups

Hydrazine (or Hydrazinium) Hydrochloride. See Hydrazine Chloride

Hydrazine (or Hydrazinium) Hydrosulfate (Hydrazinium Acid Sulfate - so called by Clark (Ref 2) and its formula is given as $N_2H_5 \cdot HSO_4$). The same compd is called **Hydrazine Sulfate** in Lange (Ref 3) and in CondChemDict (Ref 4), where its formula is given as $N_2H_4 \cdot H_2SO_4$, which amounts to the same mw for both formulas equal to 130.13 and the same props: wh crystals, sp gr 1.378, mp 254° (with evolution of gas); stable in storage, but contact with alkalis and oxidizing agents must be avoided; explodes with $NaNH_2$; v sol in hot w; diffc sol in cold w; insol in alc. Can be prepd by mixing hydrazine hydrate soln with sulfuric acid. It is a strong reducing agent. Used for prepn of other hydrazine salts and derivs; also in analysis of minerals and ores; in tests of blood; for separation of polonium from tellurium; as fungicide & germicide; and in adhesives
Refs: 1) Gmelins Hdb (1936), Syst 23, pp 559-565 2) Clark, Hydrazine (1953), 10-11 3) Lange (1961), 256 4) CondChemDict (1961), 584-R and (1971), p 451-R

Hydrazine Mononitrate. See under HYDRAZINE NITRATES

Hydrazine (or Hydrazinium) Nitrite. $N_2H_4 \cdot HNO_2$; mw 79.06, N 53.15%; decomp or explodes on rapid heating; colorless to yellowish hydr solid; sol in w & alc; insol in eth; may be prepd by mixing solns of barium nitrite and neutral hydrazine sulfate, as described in Mellor (Ref 1). Explodes violently on impact and less so when rapidly heated. When heated slowly it decomposes according to the equation: $N_2H_4 \cdot HNO_2 \rightarrow NH_3 + N_2O + H_2O$ and this decompn is greatly accelerated by nitrous acid
Refs: 1) Mellor **8**, 472-3 (1946) 2) F. Sommer, ZAnorgChem **83**, 119 (1913) 3) Clark, Hydrazine (1953), p 6

HYDRAZINE (OR HYDRAZINIUM) NITRATES

Hydrazine Mononitrate, HN, HzN, hydrazinium nitrate. $N_2H_4 \cdot HNO_3$ or $N_2H_5NO_3$; mw 95.07; N 44.20%, OB to N_2 and H_2O +8.4%; white monoclinic tablets and rods existing in 2 forms,

α & β . β form is unstable, mp 62° ; α form, stable, mp 70° ; crystal axial ratio a:b:c = 0.957:1.0:0.492; interfacial angle (polar) $88^\circ 26'$; crystal angle 90° (Ref 12); d 1.661. Médard (Ref 8) determined density at various pressures as follows: pressure in kg/sq cm, density: 34, 1.08; 88, 1.18; 136, 1.28; 204, 1.43; 306, 1.49; 425, 1.58; 680, 1.61; 1020, 1.635; 1700+, 1.64. If a concd aq soln is cooled from 100° , silky needles of β -form separate, but they undergo monotropic transition to α -form with evolution of heat at room temp. Soly in g/100g H_2O at 10° , 174.9; 20° , 266.3; 30° , 402.2; 40° , 607.2; 50° , 1034.0; 60° , 2127.0 (Ref 6)

Thermodynamic data. ΔH combustion (const vol) 112.1 kcal/kg; ΔH comb (const press) 111.1 kcal/kg; ΔH_f° (const vol) 56.7 kcal/kg; ΔH_f° (const press) 59.8 kcal/kg (Ref 10); ΔH transition β to α form 2.0 kcal/mole; ΔH_{soln} (H_2O) -8.72 kcal/mole; ΔH_{soln} (N_2H_4) +3.7 kcal/mole (Ref 21). Refractive ind at 5983Å & $25^\circ C$, α 1.605 \pm 0.004 and 1.620 \pm 0.005, β 1.458 \pm 0.003 (Ref 12). Density and viscosity curves of HN solns with hydrazine and water are given in Ref 21

Preparations. Add HNO_3 by drops (to anhyd N_2H_4 dissolved in MeOH) to pH of 5.5. HN ppts and is filtered off (Ref 10). May also be prepared from hydrazine carbonate and HNO_3 , from N_2H_5OH and HNO_3 or from $N_2H_5HSO_3$ and $Ba(NO_3)_2$ (Ref 6). Weiss (Ref 16) reacted N_2H_4 and N_2O_4 at -133° , forming HN

Toxicology. Similar to hydrazine (Ref 24)

Analytical. Infrared absorption and x-ray diffraction spectra are given in Ref 21

Thermal, combustion and explosion properties. Decomposes on heating at 1 atm to 200-300 $^\circ$ as follows: $4N_2H_5NO_3 + 2NO + 5N_2 + 10H_2O$ (Ref 9). Médard (Ref 8) measured wt loss on heating at 100° as compared with Ammonium Nitrate: HN lost 0.005%/hr of its weight at a const rate as compared to 0.016% for AN. Shidlovskii et al (Ref 14) in studying thermal decomp of function of temp found the decomposition started at 180° ; increased rapidly above 240° , at 270° became explosive. The ignition temp detd by the "Bruceton up-and-down" method which gave a 50% probability

of ignition was 307° (Ref 21). Whittaker and Barham (Ref 15), using high-speed photography measured average surface temp and melting point for NH_4NO_3 : $303^\circ \pm 12^\circ$ and $166^\circ \pm 10^\circ$; for HN: $195^\circ \pm 9^\circ$ and $74^\circ \pm 5^\circ$; and for an NH_4NO_3 -HN eutectic: $307^\circ \pm 11^\circ$ and $39^\circ \pm 6^\circ$. Equilibrium flame temp of HN detonations have been reported to be $2400^\circ C$ (Ref 21)

In the open air, HN supports combustion, but the flame was extinguished upon removal of the ignition source. To achieve stable burning Shidlovskii (Ref 14) found that addition of 10 wt-% of $K_2Cr_2O_7$ was necessary. HN ignites with permanganate, chromate-or peroxides. At slightly above its mp it will ignite with metallic Zn, or Cu, or their oxides, sulfides, nitrides or carbides (Ref 9)

Sensitivity to initiation: non-compressed HN with 0.5% moisture content, detonated with a cap contg 0.25g Mercury Fulminate; compressed to d 1.60, 1.5g MF was required for detonation (Ref 8)

Sensitivity to impact: values of 175 kg/cm and 200 to 150 kg/cm for 50% probability are reported for the "Bruceton up-and-down" method; values of 32 kg/cm and 50 kg/cm are reported for the ERL type 12 tool test (Ref 21)

Card gap sensitivity: 6.25cm; brisance 82 (TNT = 100); Trauzl lead-block test 120.4 \pm 0.5 (picric acid = 100); TNT equivalence = 1.42

Detonation velocity: Bureau of Mines detd det velocity of molten HN at 75° in thin-film expts to be 8500 m/sec (Ref 21)

Jacobs (Ref 4), with a rotating mirror camera, measured a detonation velocity of 5200 m/s with a 1" diam cartridge, 5600 m/s with a 1 5/8" diam cartridge, and 8500 m/s with a 2 1/2" diam cartridge (d of 1.6 for pressed material)

Médard (Ref 8) using a 30mm diam and 170mm long cartridge found a maximum velocity of 5640 m/sec at a d of 1.25 g/cm³. Price et al (Ref 17) reported a det velocity of 8510 m/sec at d 1.59 g/cm³ for a 6.3 cm diam charge of pressed HN. Price and co-workers found that the infinite charge diam detonation velocity, D (in m/sec) for HN can be expressed as $D = 5390 (\rho_{HN} - 100)$ in which ρ_{HN} is the d of HN in g/cm³.

ended here

Kurbangalina et al (Ref 22) found that critical diam increases with increasing water content, and that molten HN & its aq solns can detonate with different velocities (2-8 km/se). Low-velocity detonations are less dependent on critical diam than high-velocity detonations

Explosive compositions. Audrieth (Ref 11) patented an explosive compn of NH_4NO_3 78.5 - 83.5%, HN 5-10%, TNT 7.5%; Al dust 0.5%; coal 3% and chalk 0.5%. Increasing HN content to 10% increases sensitivity and detonation rate. Bridgeforth et al (Ref 20) patented explosive compns with high detonation rate and high air blasts (up to 2-fold TNT) which contain N_2H_4 and HN with or without $\text{NH}_3 + \text{NH}_4\text{NO}_3 +$ finely divided Al and a thickening agent. These compns have good cratering performance, comparable to TNT. Médard (Ref 8) examined properties of HN mixtures with NH_4NO_3 . Guanidine Nitrate, Nitroguanidine, and Ethylenediamine Nitrate.

Also examined (Ref 8) was a mixt of 6% HN in a commercial explosive of NH_4NO_3 87.5% and 12.5% wood flour. The original mixt of $d = 0.80$ required 0.80g MF for complete detonation, while the one with HN, $d = 0.90$ required only 0.30g MF for detonation. The gap test was 1.3cm for orig mixt and 4cm for mixt contg 6% HN. Incorporation of HN renders NH_4NO_3 explosives less hygroscopic. Thermal stability of HN at temps 100-200° is satisfactory and it can be incorporated in explosives loaded by casting. The low mp of HN lowers the casting temp of NH_4NO_3 mixtures (Ref 8)

Refs: 1) Gmelin's Hdb (1936), Syst 23, p 551 2) W.R.E. Hodgkinson, JSCI 32, 519 (1913) & 33, 815 (1914) & CA 9, 571 (1915) 3) Gmelins Handbuch der anorganische Chemie, Verlag Chemie, Berlin (1936), p 551 4) S.J. Jacobs, US Naval Ordn Lab Memorandum 10068 (1949) 5) A. LeRoux, MP 32, 121 (1950) & CA 47, 9014 (1953) 6) L.F. Audrieth & Betty A. Ogg, "The Chemistry of Hydrazine", J. Wiley, NY (1951) 7) L. Médard, MP 33, 323 (1951) & CA 47, 10227 (1953) 8) L. Médard, MP 34, 147 (1952) & CA 48, 6125 (1954) 9) Ch.C. Clark, Hydrazine, Mathieson Chemical Corp, Baltimore, Md (1953), p 6 10) L. Médard & M. Thomas, MP 35, 160

(1953) & CA 49, 11284 (1955) 11) L.F. Audrieth, USP 2704706 (1955) & CA 50, 8208 (1956) 12) R.J. Robinson & W.C. McCrone, AnalChem 30, 1014 (1958) & CA 52, 10681 (1958) 13) T.A. Erikson, Am-RocketSocJ 30, 190 (1960) & CA 54, 13661 (1960) 14) A.A. Shidlovskii et al, ZhPriklad-Khim 33, 1411 (1960) & CA 54, 22132 (1960) 15) A.G. Whittaker & D.C. Barham, JPhysChem 86 (1), 196 (1964) & CA 60, 6693 (1964) 16) H. Weiss, Western States Comb Inst Paper WSCI 65-20 (1965) & CA 64, 11019 (1966) 17) D. Price et al, The Detonation behavior of hydrazine mononitrate, NOLTR 66-31, Naval Ordn Lab (15 April 1966) AD 634602 18) D. Price, SympComb II, 693 (1966) & CA 67, 101557 (1967) 19) P. Breisacher et al, CombustFlame 14 (3), 397 (1970) 20) R.M. Bridgeforth et al, USP 3523047 (1970) & CA 74, 14701 (1971) 21) H.K. James et al, Physical and Explosion Characteristics of Hydrazine Nitrate, US B-of M Info Circular 8452 (March 1970) 22) A. Kh. Kurbangalina & N.N. Tinokhin, FizGoreniyaVzryva, 6 (4), 515 (1970) & CA 75, 89717 (1971) 23) A.R. Gregory et al, ProcWestPharmacolSoc 14, 117 (1971) & CA 75, 46981 (1971) 24) Sax (1968) p 819

Hydrazine (or Hydrazinium) Dinitrate.

$\text{N}_2\text{H}_4 \cdot 2\text{HNO}_3$, mw 158.08, N 35.45%, OB to N_2 and H_2O 30.4%; crystals, mp 103-104° when heated rapidly. When slowly heated it decomp at 80-85° without melting, yielding among other decomp products hydro-genazide. Even in a desiccator over sulf acid and at ord temp it decomp with evolution of hydrogen azide, leaving a residue of $\text{N}_2\text{H}_4 \cdot \text{HNO}_3$ and NH_4NO_3 . Readily sol in w, but aq solns contg more than 30% decomp on heating, d 1.64. Prepd by treating 1 mole of hydrazine hydrate with 2 moles of nitric acid. It was examined in US during WWII and found to be a more powerful explosive than Tetryl but less powerful than PETN. It is slightly less sensitive to impact than Tetryl

Ref: 1) Sabannejeff, ZAnorgChem 20, 21 (1899); not in CA 2) W.R.E. Hodgkinson, JSocChemInd 32, 519 (1913); not in CA 3) F. Sommer, ZAnorgChem 86, 71 (1914) & CA 8, 1932 (1914) 3a) Gmelins Hdb (1936), Syst 23, p 551 3b) Blatt, OSRD 2014 (1944) 4) Mellor 8, 327 (1946) 4a) ADL,

PureExplCompds (1947), p 65, Compd 142
 5) J. Barlot & S. Marsaule, *Compte rend* **226**,
 1981 (1948) & *CA* **42**, 8058 (1948) 6) L.F.
 Audrieth & Betty A. Ogg, "The Chemistry of
 Hydrazine", J. Wiley, NY (1951) 7) Ch.C.
 Clark, "Hydrazine", Mathieson Chem Corp,
 Baltimore, Md (1953), p 6

Hydrazine Nitrate Complexes. Salts of bivalent metals (Ni, Co, Zn, Cd and Mn) of complex hydrazine nitrates may be represented by the following formulas: $[M(N_2H_4)_2](NO_3)_2$, or by $[M(N_2H_4)_3](NO_3)_2$. In these complexes, called nitrohydrazinates, each N_2H_4 group plays the same role as two NH_3 groups in the corresponding ammonium complexes

For Cu and Hg the only known nitrohydrazinates contained one N_2H_4 group

Most of these complexes are stable in the dry state and remain so on heating to temperatures of at least 110° . At higher temperatures the complexes explode, some of them violently. They are nearly insol in water but are more or less hydrolyzed by it

The complex of Ni was first prepd by Franzen and Mayer (Ref 1) and the formula $[Ni(N_2H_4)_3](NO_3)_2$ was assigned to it. The same investigators prepd the nitrohydrazinates of Cd, Cu and Co

Most of these complexes were prepd by the action of aqueous soln of hydrazine on ammoniacal complexes of the nitrates of Co, Ni, etc (contg six NH_3 groups). Médard and Barlot (Ref 3) proposed the following procedure:

A soln of 20-30pts of a nitrate in 100pts of water (or preferably in ethanol) was gradually added to a mechanically agitated soln of 50pts of hydrazine hydrate in 100pts of ethanol, cooled to ca 10° . The amount of reagents should be calculated in such a manner that the final mixture contains 4 to 5% of excess of hydrazine

As soon as all the nitrate was added the mixture was poured into a Büchner funnel connected to a suction flask. The resulting precipitate was washed with methanol or ethanol until the elimination of hydrazine was complete and dried first in air and then in a steam oven at 100°

Note: During the investigation of various methods of preparation, it was observed by Barlot (Ref 2) that if solns of equimolecular amounts of nickel nitrate and hydrazine nitrate are mixed no precipitation is observed. If, however, some hydrazine, or ammonia is added, an immediate precipitation of pink complex is observed

Cadmium Nitrohydrazinate. $Cd(NO_3)_2 \cdot 3N_2H_4$.
 Calcd: Cd 33.7% and N_2H_4 28.9; found: Cd 33.1% and N_2H_4 28.5%. White cryst powder, explodes on strong impact (such as of 2kg wt falling from the height of 3m) or on rapid heating to ca 245° ; when spread in a thin layer it burns while melting and evolving brown fumes (Ref 3)

Cobalt Nitrohydrazinate. $Co(NO_3)_2 \cdot 3N_2H_4$.
 Calcd: Cd 21.0% and N_2H_4 34.5%; found: Co 22.1% and N_2H_4 32.5%. Brownish (bister color) microcryst powder; explodes violently on impact (such as of 2kg wt falling from the height of 1.75m) or on heating to ca 210° . Addn of 25% water decreases sensitivity to drop test. Explodes also on contact with concd acid. It is unstable and decomposes slowly even in the presence of traces of water changing to a greenish color (Ref 3)

Manganese Nitrohydrazinate. $Mn(NO_3)_2 \cdot 2N_2H_4$.
 Calcd: Mn 22.8% and N_2H_4 33.6%; found: Mn 23.6% and N_2H_4 33.5%. Reddish (ochre) colored hexagonal crystals; ignites easily ca 150° , produces copious fumes of Mn oxide; is insensitive to shock (Ref 3)

Nickel Nitrohydrazinate. $Ni(NO_3)_2 \cdot 3N_2H_4$.
 Calcd: Ni 21.0% and N_2H_4 34.5%; found: Ni 21.3% and N_2H_4 34.0%. Rose-violet colored microcrystals; explodes violently on impact (such as of 2kg wt falling from the height of 1.50m) or on heating to ca 215° ; the explosion is accompanied by a loud noise and a brilliant flash. Addn of 25% water decreases sensitivity to drop test. Power in the French lead block test (cup) ca 85 (PA 100) which is higher than for MF or LA. In cellophane tubes 200mm long at $d = 0.62$ (MF detonator), the velocity of detonation by the Dautriche method for various tube diams were: 2600 m/sec at 6mm diam; 2900 and 3100 at 8mm; 2700 at 10mm; 2900 at 12mm; and 3500 at 15mm (Ref 3)

Ellern and Olander (Ref 4) report a spontaneous explosion of a thoroughly washed and dried nickel nitrohydrazinate $[\text{Ni}(\text{N}_2\text{H}_4)_3(\text{NO}_3)_2]$ after exposure to the atm for 10 min

Barlot and Medard (Refs 2 & 3) describe an analytical procedure for nickel nitrohydrazinate: decompose the complex cautiously (to avoid an explosion) by means of concd H_2SO_4 and determine Ni content by means of dimethylglyoxime. Determine the hydrazine content by means of an iodate soln

Uses: The possibility of using Ni nitrohydrazinate in commercial detonators was investigated by loading Cu caps of 5mm diam with 2.5g of Ni complex and trying to detonate them by means of a fuse, or an electric igniter. No detonations were produced unless the substance was primed by ca 1.5g of Black Powder

In attempts to increase the detonability of Ni hydrazinate, it was mixed with equal parts of an easily ignitable initiating substance, such as Pb-styphnate or Pb-picrate, and then ignited. The best that could be obtained was a deflagration but no detonation. Mixtures of the Ni complex with RDX deflagrated and only in one case detonated (Ref 3)

Zinc Nitrohydrazinate. $\text{Zn}(\text{NO}_3)_2 \cdot 3\text{N}_2\text{H}_4$. Calcd: Zn 22.8% and N_2H_4 33.6%; found Zn 23.0% and N_2H_4 33.5%. White crystalline powder (apparently hexagonal); explodes occasionally under very strong impact (less sensitive than any of the above complexes with the exception of Mn); ignites with crackling and greenish sparks on heating to ca 310° (Ref 3)
Conclusions. The following conclusions about the explosive properties of complex metallic nitrohydrazinates were drawn by Médard and Barlot (Ref 3):

a) the complexes of Ni, Co and Cd possess properties similar to primary and initiating compounds, such as Mercury Fulminate

b) they are much less sensitive to shock than Mercury Fulminate or Lead Azide and are more powerful

c) they are much more difficult to ignite by means of a fuse, or an electrical igniter, than Mercury Fulminate and even when ignited they do not detonate but only deflagrate. This is also true, in a lesser degree, for mixtures of above complexes with more

ignitable initiating compound, such as Lead Styphnate

d) The complex Styphnate of Ni hydrazinate also deflagrated & did not detonate
Ref: 1) H. Franzen & O.V. Mayer, *ZAnorg-Chem* **60**, 266 (1908) 2) J. Barlot, *Dérivés complexes de l'hydrazine et de quelques nitrates métalliques*, 24^e Congrès de chimie industrielle, Paris (1951) 3) L. Médard & J. Barlot, *MP* **34**, 159-166 (1952) & *CA* **48**, 6125 (1954) 4) H. Ellern & D. Olander, *JChemEd* **32**, 24 (1955) & *CA* **49**, 6607 (1955)

Hydrazine (or Hydrazinium) Perchlorate, Hydrazinium Perchlorate, $\text{N}_2\text{H}_4 \cdot \text{HClO}_4$ or $\text{N}_2\text{H}_5\text{ClO}_4$; mw 132.51; N 21.13%, OB to Cl_2 and H_2O +18.1%; orthorhombic crystals; for a study of crystal structure see Conant and Rooj (Ref 16); mp $131-132^\circ$; d 1.939 (diperchlorate d 2.21, mp 191°); soly in H_2O : temp, g/100g satd soln: 0° , 23.68; 40° , 68.9; 60° , 87.4; 75° , 93.1 (Ref 3). Carleton & Lewis (Ref 11) studied the phase equilibria of Hydrazine Perchlorate-water system and observed: the limiting melting temp of the salt, 142.4° ; the occurrence of a solid hydrate decomp at 64° with a eutectic point at -4.1° and 80% H_2O ; hydrate identified as $\text{N}_2\text{H}_4\text{ClO}_4 \cdot \frac{1}{2}\text{H}_2\text{O}$; quadruple pt 64° and 88mm Hg. ΔH of addn of N_2H_4 to $\text{HClO}_4 = -44.4$ kcal/mole; ΔH of addn of HClO_4 to $\text{N}_2\text{H}_4 \cdot \text{HClO}_4 = -18.8$ kcal/mole; $\Delta\text{H}_f^\circ = 40.69 \pm 0.36$ kcal/mole (Ref 15) or -42.9 ± 0.2 kcal/mole (Ref 5); ΔH_f° for diperchlorate = -70.1 ± 1.0 (Ref 7); $\Delta\text{H}_{\text{soln}} = 33.11$ kcal/mole; ΔH diln 1:1000 = $+9.77$ kcal/mole

Preps: May be prepd by addn of concd HClO_4 to aq soln of N_2H_4 neutralizing and cooling to 0° (Ref 3). Byrne (Ref 14) prepd anhyd perchlorate by metathesis of a hydrazine salt with an inorg perchlorate dissolved in a lower aliphatic alcohol. Stern (Ref 6) prepd the hemihydrate by adding N_2H_4 to an aq soln of NH_4ClO_4 , heating to remove H_2O and NH_3 , and cooling below transition temp to crystallize

Analytical: Jacobs & Russell-Jones (Ref 12) detd the IR spectrum and assigned absorption bonds

Toxicology: Unknown. Probably toxic (Ref 18)

Use: Rocket propellant (Ref 17)

Thermal, combustion and explosion properties:

Bartot and Marsoule (Ref 3) reported the salt melting to a colorless liquid at 137-8°, with decompn beginning at 145°, becoming complete at 230°. Grelechi and Cruice (Ref 9) using a manometric technique to study thermal decompn, found the reaction rate to be proportional to the amt of free HClO₄ present. Shidlovskii et al (Ref 5) detd the rate of thermal decompn at different temps. They also measured the vol of gases evolved in decompn to be 864 l/kg. Jacobs and Russell-Jones (Ref 12) studied the thermal decompn of the hemihydrate. In vacuo it will partially dehydrate even at room temp; when heated, the remainder of the 0.5 mole H₂O is lost at 61°. At low temps, decompn is represented by the equation:
 $2\text{N}_2\text{H}_5\text{ClO}_4 \cdot 0.5\text{H}_2\text{O} \rightarrow 0.8\text{NH}_4\text{ClO}_4 + 0.7\text{O}_2 + 1.6\text{N}_2 + 0.6\text{Cl}_2 + 4.4\text{H}_2\text{O}$, but at high temp the rate of decompn of NH₄ClO₄ formed becomes appreciable. When ignited, hydrazine perchlorate burns without exploding. The flame temp is 2200°

Friedman and Levy (Ref 8) and Levy et al (Ref 13) investigated deflagration behavior. Levy et al (Ref 10) studied deflagration of hydrazine perchlorate both pure and with fuel and catalyst additives (Cu chromite, K₂Cr₂O₇ and MgO). Deflagration rates were measured photographically from 0.26 to 7.7 atm. Shidlovskii et al (Ref 5) studied ignition behavior. Ignition temp, 277-80°, was lowered to 254-9° by addn of 5% MnO₂, and addn of 5% CuCl₂ resulted in explosion at 170°. In 1.05cm diam tubes hydrazine perchlorate did not ignite, but with 5% MnO₂, CoO or Cu₂Cl₂ it maintained self combustion at room temp. The rate of burning in the presence of additives decreased in the order Cu₂Cl₂ > CoO > MnO₂. Self combustion was not maintained in the presence of 5% CuCl₂·2H₂O, but in the presence of 2.5% CuCl₂·2H₂O + 2.5% CuCl₂ about 2/3 of the perchlorate burned out before the residue exploded. The rate of burning of the perchlorate was 2-3 times as high as that of NH₄ClO₃. Hydrazine perchlorate is an explosive comparable in power to the chlorate but is more stable. Salvadori (Ref 1) proposed using it in primary and initiating mixtures. Blatt (Ref 1b) gives its power by Trauzl Test

as 113% PA, while ADL (Ref 1c) gives 122% TNT. Impact sensitivity FI 12% PA (Ref 1b). In air it forms a semi-hydrate, mp 85°, which is insensitive to impact (Ref 1b)

Refs: 1) R. Salvadori, GazzChimItal **37** (2) 32 (1907) & CA **2**, 182 (1908) 1a) Gmelins Hdb (1936), Syst 23, p 556 1b) Blatt, OSRD **2014** (1944) 1c) ADL, Synthesis HE's, 1st Rept (1949), p 69, Compd 43 2) Ullmann **6**, p 206 (1951) 3) J. Bartot & S. Marsoule, Compt rend **228**, 1497 (1949) & CA **43**, 8934 (1949) 4) C.C. Clark, Hydrazine, Mathieson Chem Corp, Baltimore (1953) p 14 5) A.A. Shidlovskii et al, ZhPrikKhim **35**, 756 (1962) & CA **57**, 5285 (1962) 6) D.R. Stern, USP 3131997 (1964) & CA **61**, 9198 (1964) 7) R. Caruso et al, JPhysChem **69**, 1716 (1965) & CA **63**, 71 (1965) 8) R. Friedman & J.B. Levy, AD 351940 (1966) & CA **66**, 97033 (1967) 9) C.S. Grelechi & W. Cruice, Advan ChemSer **54**, 73 (1965) & CA **65**, 4992 (1966); ACS Div FuelChem Preprints **9**, 80 (1965) & CA **65**, 18415 (1966) 10) J.B. Levy et al, AdvanChemSer **54**, 55 (1965) & CA **65**, 5294 (1966) 11) L.T. Carleton & R.E. Lewis, JChemEngData **11** (2), 165 (1966) & CA **65**, 86 (1966) 12) P.W.M. Jacobs & A. Russell-Jones, CanJChem **44** (20), 2435 (1966) & CA **65**, 16482 (1966) 13) J.B. Levy et al, US DeptCommerce AD 628035 (1967) & CA **66**, 77925 (1967) 14) J. Byrne (Monsanto) USP 3537924 (1967) & CA **67**, 71 (1967) 15) V. Ya. Rosolonskii et al, ZhNeorgKhim **13** (3), 681 (1968) & CA **69**, 13538 (1968) 16) J.W. Conant & R.B. Rooj Jr, ActaCrystallogr Sept B **26** (12), 1928 (1970) & CA **74**, 46614 (1971) 17) CondChemDict, Van Nostrand, NY (1971) p 451 18) Sax (1968) p 820

Hydrazine Perchlorate and Chlorate Complexes.

Salts of hydrazine chlorate and perchlorate complexes, such as [Co(N₂H₄)₂](ClO₃)₂, yellow cryst, and [Co(N₂H₄)₂](ClO₄)₂, were first prepd by Salvadori (Ref 1). Friederich and Vervoort (Ref 2) describe a number of complexes (Cu, Cd, Ni, Co & Zn) prepd by adding a soln of hydrazine hydrate in H₂O or EtOH to a soln of a metallic chlorate or perchlorate with cooling and agitation, and washing and drying the ppt at low temperatures. For example, [Ni(N₂H₄)₂](ClO₃)₂, also Cd

and Cu chlorates and perchlorates, were prepared and their explosive characteristics were studied. They were found to be powerful and sensitive explosives, claimed to compare favorably with standard initiating explosives. Violent decomposition occurs, presumably in accordance with the following hypothetical equations:

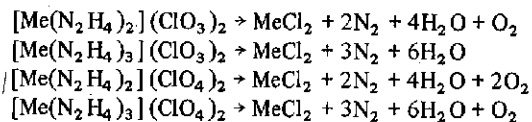

The chlorates are more sensitive than the perchlorates (Ref 2); the Cu-chlorate complex detonates even on drying at room temperature. Maissen & Schwarzenbach (Ref 3) attempted to prepare $[\text{Ni}(\text{N}_2\text{H}_4)_2](\text{ClO}_4)_2$ by mixing $\text{Ni}(\text{ClO}_4)_2$ and N_2H_4 in water. After 5 days a blue ppt formed. When a glass stirring rod was introduced into the suspension, a violent explosion resulted
Refs: 1) R. Salvadori, *Gazz* **40**, 11, 9 (1910) & *CA* **5**, 1568 (1911); *Gazz* **42**, 448 (1912); *JCS* **98**, 11, 959 (1910) 2) W. Friederich & P. Vervoort, *SS* **21**, 49 (1926) & *CA* **21**, 1184 (1927) 3) B. Maissen & G. Schwarzenbach, *HelvChimActa* **34**, 2084 (1951) & *CA* **46**, 3280 (1952)

Hydrazine Picrate. See under HYDRAZINE SALTS OF ORGANIC ACID

HYDRAZINE, REACTIONS WITH METALS AND THEIR SALTS.

Lithium dissolves slowly in anhydrous hydrazine with evolution of hydrogen and nitrogen. In the presence of $\text{N}_2\text{H}_5\cdot\text{HSO}_4$ the reduction is much more rapid

Ref: Clark, *Hydrazine* (1953), p 4

Mercuric Oxide. Explosive action between HgO and hydrazine hydrate was observed by Curtius & Schrader

Refs: 1) Th. Curtius & F. Schrader, *JPrakt-Chem* [2] **50**, 320 (1894) 2) Clark, *Hydrazine* (1953), p 5

Potassium reacts with anhydrous hydrazine with explosive violence

Refs: 1) T.W.B. Welsh & H.J. Broderick, *JACS* **37**, 816-24 (1915) 2) Clark, *Hydrazine* (1953), p 4

Sodium reacts with aqueous or anhydrous hydrazine with formation of $\text{NaNH}_2\cdot\text{NH}_2$. When dry the salt is extremely explosive

Refs: 1) Gmelin's Hdb (1928), Syst 21, p 260
 2) T.W.B. Welsh, *JACS* **37**, 497-508 (1915)
 3) Clark, *Hydrazine* (1953), p 4

HYDRAZINE SALTS OF ORGANIC ACIDS

Hydrazine-N,N'-dicarbonic Acid Diazide

(Hydrazin-N,N'-dicarbonsäure, in Ger)

$\text{N}_3\text{C}(\text{O})\text{HN}(\text{O})\text{NH}(\text{O})\text{C}(\text{O})\text{N}_3$; mw 170.10, N 65.88, OB

to CO_2 -28.2%; crystals, mp 150-52 (decomp) and explodes if heated rapidly. Was obtained in 20% yield as by-product of the action of nitrous acid on the hydrazide of dicarbonic acid. It is primary type expl more sensitive to impact than Lead or Silver Azides. One g of TNT can be initiated by 0.25g of this expl

Refs: 1) Beil **3**, (60) & [102] 2) W. Kesting, *Ber* **57**, 1321 (1924) 3) Blatt, *OSRD* **2014** (1944) 4) ADL, *Pure Expl Compds*, Part 1 (1947), p 51, Compd 141

Hydrazine picrate, $\text{N}_2\text{H}_4\cdot\text{C}_6\text{H}_2(\text{NO}_2)_3\text{OH}$; mw 261.2, N 26.8%; OB -52.0%; soly detd by Gilbert & Huffman (Ref 1) in EtOH-H₂O mixtures. Soly curve showed maxima & minima but no evidence of a stable alcoholate. Water of hydration was retained even in 99.8% EtOH. Forth (Ref 3) studied thermal stability of amine salts of Picric Acid; and rated, in order of increasing stability the following salts: Hydrazine Picrate; Aminoguanidine Picrate; N-Methylguanidine Picrate; Guanylurea Picrate; N-Ethylguanidine Picrate; and Guanidine Picrate. Christensen & Gilbert (Ref 2) plotted the vapor pressure curve of the hydrated picrate, $\text{N}_2\text{H}_4\cdot\text{C}_6\text{H}_2(\text{NO}_2)_3\text{OH}\cdot\frac{1}{2}\text{H}_2\text{O}$; up to its melting point and found no break in the curve. It holds the water of hydration very tenaciously and begins to have an appreciable vapor pressure only at temps around 100°; calculated ΔH of dehydration is 16.855 kcal/mole and calculated $\Delta\text{F}_{298.1}^\circ$ is 2705 cal. No explosive props mentioned, but is evidently explosive

Refs: 1) E.C. Gilbert & E.H. Huffman, *JPhys-Chem* **36**, 2789 (1932) & *CA* **27**, 459 (1933) 2) B.E. Christensen & E.C. Gilbert, *JACS* **56**, 1897 (1934) & *CA* **28**, 6615 (1934) 3) M.I. Fauth, *AnalChem* **32**, 655 (1960) & *CA* **54**, 1594 (1960)

Hydrazine Styphnate and Hydrazine Styphnate complex. Fauth (Ref 2) examined relative stability in terms of the temp of explosion of amine salts of styphnic acid, and rated, in order of increasing stability, the following salts: Hydrazine Styphnate; N-Methylguanidine Styphnate; N-Ethylguanidine Styphnate; Guanidine Styphnate; Guanylurea Styphnate; and Aminoguanidine Styphnate. The impact sensitivity of the styphnates as indicated by the 5kg drop test, in order of increasing sensitivity was: Aminoguanidine Styphnate; Guanidine Styphnate; N-Ethylguanidine Styphnate; N-Methylguanidine Styphnate; Guanylurea Styphnate and Hydrazine Styphnate

Medard & Barlot (Ref 1) prepd a small quantity of a Hydrazine Styphnate complex of Ni (no formula given) by dissolving freshly pptd Ni hydroxide in an aq soln of styphnic acid and treating the soln with aq hydrazine. The resulting ppt was dried and tested for following properties: Flammability: the complex, either alone or in mixts with RDX, was just as difficult to ignite by means of a fuse, or an electrical igniter as was the corresponding complex Ni-nitrohydrazinate. When ignited, the complex styphnate did not detonate and for this reason is considered to be unsuitable for use in detonators. Sensitivity to impact: explosions were obtained 20% of the time on dropping a 2kg hammer from the height of 1.5m, and 40% of the time from a height of 2.5m
Refs: 1) L. Médard & J. Barlot, MP 34, 165 (1952) & CA 48, 6125 (1954) 2) M.L. Fauth, AnalChem 32, 655 (1960) & CA 54, 1594 (1960)

HYDRAZINE SUBSTITUTED DERIVATIVES:

Alkyl Substituted Hydrazines & Derivs

Of the many alkyl substituted hydrazines, only two are used as rocket fuels now: monomethyl hydrazine (MMH), CH_3NHNH_2 , and unsymmetrical dimethylhydrazine (UDMH), $(\text{CH}_3)_2\text{NNH}_2$. (See Hypergolic Fuels in this Vol for combustion properties as rocket fuels). Their physical properties are summarized below

Monomethyl hydrazine, MMH, CH_3NHNH_2 , mw 46.07; N 59.7%; fp -52.4° , bp 87.5° ,

d 0.871 at 26° , heat of formation $+12.7\text{kcal/mole}$, heat of combstn -311.7kcal/mole , explosive limits in air 2.5 to 98%, vapor pressure 49.63mm Hg at 25° , viscosity 19.0cps at -55° . For other props see below. May be prepd by the alkylation of hydrazine:

$\text{CH}_3\text{Cl} + 2\text{N}_2\text{H}_4 \rightarrow \text{CH}_3\text{NHNH}_2 + \text{N}_2\text{H}_4 \cdot \text{HCl}$ or by reaction of NH_2Cl with methylamine (Ref 3). Liquid MMH is not sensitive to impact or friction. It is hypergolic with some oxidants, such as H_2O_2 , N_2O_4 , fluorine and nitric acid. When a film of MMH comes into contact with metallic oxides, such as those of iron, copper, lead and manganese, it may ignite owing to the chemical heat of decomposition (Ref 5)

Unsymmetrical Dimethylhydrazine, UDMH, $(\text{CH}_3)_2\text{NNH}_2$; mw 60.10; N 46.62%, density 0.784 at 25° ; fr p -57° ; bp 63° ; Refr Index 1.4058 at ca 25° ; fl p (Tag CC) 34°F ; vap press 157mm at 25° ; viscosity 0.51cps at 25° ; flammability limits -15° to ca 60° ; spontaneous ignition in air 250° ; heat of formn (endothermic) 12.74kcal/mole at 25° ; heat of combstn -474.11kcal/mole ; impact sensitivity—not detonable by 100g Tetryl chge; may be prepd by reduction of nitrosodimethylamine (Ref 3). Korablina et al (Ref 6) prepd the perchlorate salt of UDMH by reacting the base with HClO_4 at $50-60^\circ$, cooling or evapg to deposit crystals. Resulting salt is sol in H_2O and detonates easily

UDMH is known to be miscible with the following: water, benzene, triethyl benzene, toluene, kerosene, ethyl alcohol, isobutyl alcohol, n-butyl ether, n-amyl ether, n-hexyl ether, diethyl ether, petroleum ether, petroleum naphtha, n-heptane, n-hexane, n-octane, n-decane, n-dodecane, n-hexadecane, cyclohexane, 1,2-dimethyl cyclohexane, phenyl cyclohexane, n-tetradecane, trichloroethylene, dichloroethylene, perchloroethylene, 1,1,1-trichloroethane, triethyl amine, ethylenediamine, diethylene triamine, acetonitrile, aniline, cumene, tetrahydronaphthalene, tetraethylene pentamine, ethylene glycol and hydrazine (Ref 4)

UDMH should always be handled under a blanket of N (Ref 4)

Other alkyl hydrazines. Picard & Boivin (Ref 2) studied the action of 100% HNO₃, mixed at -30° with acetic anhydride, on various symmetrical disubstituted hydrazines. Westphal & Euhén (Ref 1) studied in great detail the properties and thermal disson of various tetra-alkylhydrazines

Refs: 1) O. Westphal & M. Euhén, Ber, **76B**, 1137 (1943) & CA **38**, 4916 (1944) 2) J.P. Picard & J.L. Boivin, CanJChem **29**, 223 (1951) & CA **45**, 9469 (1951) 3) Jet Propulsion, p 399 (April 1957) 4) J. Heriches et al, US B of M RI 5635 (1960) 5) The Handling & Storage of Liquid Propellants, Office of the Director of Defense Research & Engineering (Jan 1963) 6) L.S. Korablina et al, IzvVysshikhUchebZaved, Khim i Khim Tekhnol **9** (3) 351 (1966) & CA **66**, 2147 (1967)

Hydrazine Substituted Aryl Derivatives

N,N'-dinitro-N,N'-dibenzoylhydrazine. PhCON(NO₂)₂N(NO₂)₂COPh,

mp 101.5°; may be prep'd by reaction of nitric acid-acetic anhydride mixtures with N,N'-dibenzoylhydrazine; reacts with conc'd H₂SO₄, giving off nitrogen oxides (Ref 3)

2,4-dinitrophenylhydrazine. 2,4-(NO₂)₂PhNHNH₂,

may be prep'd by reaction of 2,4-(NO₂)₂PhCl, AcOK and N₂H₄·H₂SO₄ (Ref 1); ΔH_{comb} 3950 cal/g at const press, ΔH_f^o 9.2 kcal/mole at const press (Ref 4)

2,6-dinitrophenylhydrazine. 2,6-(NO₂)₂PhNHNH₂,

may be prep'd from 2,6-(NO₂)₂PhCl, AcOK and N₂H₄·H₂SO₄ (Ref 1)

2,4,6-trinitrophenylhydrazine. 2,4,6-(NO₂)₃-PhNHNH₂,

may be prep'd from picryl chloride, AcOK and N₂H₄·H₂SO₄ (Ref 1); ΔH_{comb} 3070 cal/g at const press, -ΔH_f 5.8 kcal/mole (Ref 4)

α-(2,4,6-trinitrophenyl)-α-methylhydrazine. 2,4,6-(NO₂)₃PhN(CH₃)NH₂;

crystals; mp 170°; may be prep'd by reacting MeNHNH₂·H₂SO₄ with NaOH, filtering, and reacting filtrate with picryl chloride (Ref 2)

Written in collaboration with E. L. CAPENER
R. M. WRIGHT

Refs: C.F.H. Allen, Org Syntheses **13**, 36 (1933) & CA **27**, 3921 (1933) 2) J.J. Blansma & M.L. Wackers, RevTravChim **55**, 661 (1936) & CA **30**, 7105 (1936) 3) J.P. Picard & J.L. Boivin, CanadJChem **29**, 223 (1951) & CA **45**, 9469 (1951) 4) L. Médard & M. Thomas, MémPoudr **36**, 97 (1956) & CA **50**, 3763 (1956)

Hydrazine (or Hydrazinium) Sulfate. The name given in Clark (Ref 4) to the comp'd which is actually **Dihydrazinium Sulfate** (N₂H₅)₂SO₄·H₂O. It is prep'd either by neutralization of hydrazine hydrate soln by sulfuric acid or by neutralization of hydrazine hydrosulfate, followed by evaporation of soln at 60° to obtain crystals of Dihydrazinium Sulfate, Monohydrate, melting at 118.9°. Anhydrous salt can be obt'd on slow cooling but in contact with soln it is stable only above the transition point, 47.3°; storage over P₂O₅ gives anhydrous salt. The monohydrate is hygroscopic but insol in alc. Moist crystals have neutral pH. Can be used for prep'n of other hydrazines [See also Hydrazine (or Hydrazinium) Hydrosulfate]

Refs: 1) Gmelins Hdb (1936), Syst 23, p 560 2) F. Summer & K. Weise, ZAnorgChem **94**, 51-91 (1916) & CA **10**, 1139-4 (1916) 3) B.E. Christensen & E.C. Gilbert, JACS **56**, 1897099 (1934) 4) Clark, Hydrazine (1953), 10

Hydrazine and Derivatives, Analytical Procedures.

The following procedures are described in the book of Clark, Hydrazine (Ref 5): p 114—Direct Iodate Method Using Solvent, originally described in Ref 4

pp 114-15—Direct Iodate Method with Internal Indicator, originally described in Ref 4

p 115—Sulfate in Hydrazine by the method developed by Mathieson Chem Corp

pp 115-16—Ammonia in Hydrazine by the method developed by Mathieson Chem Corp

pp 116-17—Iron in Hydrazine. Colorimetric method with α,α'-Dypyridyl, earlier described in Refs 1 & 2

pp 117-19—Sulfides in Hydrazine, earlier described in Refs 2 & 3

p 119—Chloride in Hydrazine by the method developed by the Mathieson Chem Corp

The method for estimation of hydrazine content in unknown materials is described in

Std Methods Chem Analysis (Ref 6). The method consists of titration with 0.1M KIO_3 soln, standardized against pure $\text{N}_2\text{H}_4 \cdot \text{H}_2\text{SO}_4$

Refs: 1) F.D. Snell & C.T. Snell, "Colorimetric Methods of Analysis", VanNostrand, NY, Vol 1 (1936), p 310 2) W.W. Scott, "Standard Methods of Chemical Analysis", Van Nostrand, NY, Vol 1, (1939), p 914 3) H.H. Willard & H. Dietl, "Advanced Quantitative Analysis", Van Nostrand, NY (1943), p 194 4) R.A. Penneman & L.F. Audrieth, AnalChem 20, 1058-61 (1948) 5) Ch.C. Clark, "Hydrazine", Mathieson Chem Corp, Baltimore, Md (1953), pp 114-19 6) R.H. Pierson, Edit, "Standard Methods of Chemical Analysis", Vol 2, Part B, Van Nostrand, Princeton, NJ (1963), p 1317

Hydrazine, Propellant, US Military Specifications Requirements and Tests are given in MIL-P-26536C (May 1963), superseding MIL-P-26536B (March 1964)

1. SCOPE

1.1 This specification covers the requirements for hydrazine (N_2H_4) propellant

3. REQUIREMENTS

3.1 **Chemical and physical properties.** The chemical and physical properties of the propellant shall conform to those listed in table I when tested in accordance with the applicable test methods

Table I Chemical and Physical Properties

Properties	Limits	Test Paragraph
Hydrazine assay (percent by weight)	98 min	4.5.2
Water (percent by weight)	1.5 max	4.5.2
Particulate (milligrams per liter)	10 max	4.5.3

3.2 **Limiting values.** The following applies to all specified limits in this specification. For purposes of determining conformance with these requirements, an observed value or a calculated value shall be rounded off "to the nearest unit" in the last righthand place of figures used in expressing the limitation value, in accordance with the rounding-off method of the Recommended Practices for Designating Significant Places in Specified Limiting Values (ASTM Designation: E-29)

3.3 **Filter.** A filter with a 10-micron nominal and 40 absolute rating shall be installed between the manufacturer's plant system and the container to be filled for delivery

3.4 **Qualitative.** The propellant shall be a colorless, homogeneous liquid when examined visually by transmitted light

4. QUALITY ASSURANCE PROVISIONS. See in Specification

4.5 Test Methods

4.5.1 **Examination of product.** The propellant shall be visually examined while performing test specified in 4.5.3 to determine compliance with the requirement as specified herein. Examination to ensure that the material conforms to 3.4 shall be conducted after the sample has been transferred to the 500-ml calibrated cylinder

4.5.2 **Hydrazine assay and water.** The propellant and water content of the sample shall be determined by the following method

4.5.2.1 Gas chromatographic method

4.5.2.1.1 Suggested column preparation.

Weigh 10 grams of polyethylene glycol 400 and 20 grams of Anakrom B support material into separate beakers. Dissolve the polyethylene glycol 400 in reagent grade methylene chloride (dichloromethane). The final volume of the solution should be approximately that of the support material. Pour the support material into the polyethylene glycol 400 (stationary phase) solution with gentle stirring. Evaporate the solvent by spreading the mixture in a tray. Occasionally turn the mixture gently during the drying process. The column packing material is dry when it becomes a free-flowing powder. Fill a 1/4 inch x 1 meter (39.4 inches) stainless steel tube by pouring the prepared material thru a small funnel attached to one end. The bottom of the tubing is plugged with a small wad of glass wool. Tap gently or use a mechanical vibrator to facilitate packing. When the column is full, plug the inlet with glass wool and bend the tubing to the configuration required by the chromatograph oven

4.5.2.1.2 **Procedure.** Install the prepared column into the gas chromatograph but do not connect the column to the detector inlet. Condition the column for at least 4 hours by heating at 302°F (150°C) with the carrier gas (helium) flow set at approximately 50 milli-

liters per minute. After conditioning the column, set the column oven temperature at 230°F (110°C) and connect the column to the detector inlet. Adjust the carrier gas flow to 80–120 milliliters per minute. If the gas chromatograph is equipped with separate injector and detector temperature controls, set the detector at 302°F (150°C) and the injector at 230°F (110°C). Saturate the column by injecting two or three 10-microliter samples of propellant. Saturate the column prior to each series of analyses. When more than 30 minutes elapse between the elution of the hydrazine and the injection of a new sample, resaturate the column with one 10-microliter injection of propellant sample. Use a clean, dry 10-microliter hypodermic syringe and draw up 8 microliters of sample. Invert the syringe and expel the gas bubbles. Carefully set the syringe plunger to the 3-microliter mark and wipe the tip with a piece of tissue without touching the open end of the needle. Quickly inject the sample into the instrument injection port and then withdraw the syringe immediately. Measure the areas of all peaks in the chromatogram. The analyst may vary the temperature, flow rate, column size, and sample size to optimize the analysis

4.5.2.1.3 Calculations

$$\%N_2H_4 = \frac{A_{N_2H_4}}{\Sigma A_i} \times 100$$

$$\%H_2O = \frac{A_{H_2O}}{\Sigma A_i} \times 100$$

Where:

$A_{N_2H_4}$ = the measured area of the N_2H_4 peak multiplied by its signal attenuation factor

A_{H_2O} = the measured area of the H_2O peak multiplied by its signal attenuation factor

ΣA_i = the sum of all the measured peak areas in the signal attenuation factors

Assumption: The thermal conductivities of all components in the sample are equal

4.5.2.1.4 *Equipment and reagents.* The following equipment and reagents shall apply as test conditions of 4.5.2

(a) Equipment

- (1) Gas chromatograph: incorporating

a thermal conductivity detector

- (2) Recorder: potentiometric strip chart, 0–1 millivolt, 1 second F.S. response, with integrator
- (3) Tubing: stainless steel, 1/4 inch O.D. x 1 meter (39.4 inches).
- (4) Hypodermic syringe: 10 microliter, fixed needle
- (5) Regulator: helium, to fit the cylinder

(b) Reagents

- (1) Anakrom B: 90/100 mesh, Analabs, Inc, 9 Hobson Ave, Hamden, CT 06518, or equivalent
- (2) Polyethylene glycol 400: Carbowax 400, or equivalent
- (3) Methylene chloride: ACS reagent grade
- (4) Helium gas: conforming to MIL-P-27407

4.5.3 **Particulate.** The propellant sample shall be tested for contamination in accordance with ASTM Designation D-2276-65T, Method A, with the following exceptions

4.5.3.1 Mix the sample thoroughly by shaking the sample container. Immediately pour 500ml of the sample into a clean 500-ml graduated cylinder. Use this 500ml of propellant for the particulate analysis

4.5.3.2 Use a solvent resistant filter disc made from such materials as Millipore LSWP 04700, (Mitex-Teflon), Millipore URWP 04700, (Solvinert), or Gelman VF-6, (Fluoride-Metricel), plain, white, 10±3 microns, 47mm diameter instead of the filter specified in Method 2276-65T

4.5.3.3 The drying oven temperature shall be 158°F (70°C) instead of the 194°F (90°C) specified in Method 2276-65T

4.5.3.4 Filtered isopropyl alcohol shall be used for rinsing the sample bottle and filter holder instead of petroleum ether specified in Method 2276-65T

6. Notes

6.1 **Intended use** of propellant described in this specification is as a fuel in rocket engines

6.2 **Particulate** is the undissolved solid retained on a 10-micron filter membrane

6.3 **Density.** For informational purposes, the range of density for material conforming to this Spec is 1.002–1.008g/ml at 25° (77°F)

Hydrazinobenzene and Derivatives

Hydrazinobenzene or Phenylhydrazine (called Hydrazino-benzol in Ger), $C_6H_5 \cdot HN \cdot NH_2$; mw 108.14, N 25.91%; pale-yel monoclinic crystals or oily liq, mp 19.5° , bp 243.5° (with decompn), flash p $192^\circ F$ (CC), auto ign temp $345^\circ F$, d 1.0978; sol in alc, eth, chl, benz, w and dil acids. Can be prep'd by reduction of diazotized aniline, followed by reaction with NaOH.

Hydrazinobenzene is highly toxic by inhalation, ingestion & skin absorption. It forms a hydrate with 0.5 water. Used in anal chem as reagent for aldehydes & sugars, and in org syntheses.

Also as fuel additive and gas absorbent

Refs: 1) Beil 15, 67, (23), [44] 2) H. Gilman, Org Syntheses Coll Vol 1 (1932), p 442 (G.H. Coleman) 3) Clark, Hydrazine (1953), p 33 (Prepn), pp 39, 97, 99 & 100 (Uses) 4) Sax (1968), 1013 5) CondChemDict (1971), 681

Hydrazinomononitrobenzene or Mononitrophenylhydrazine, $O_2N \cdot C_6H_4 \cdot NH \cdot NH_2$; mw 153.14, N 27.44%. Three isomers are known: *2-Nitro-*, brick-red ndls (from benz), mp 90° (Ref 1)

3-Nitro-, yel-orn ndls (from alc), mp 93° (Ref 2)

4-Nitro-, orn-red lfths or ndls (from boiling alc), mp 157° (dec) (Ref 3)

Other props & methods of prep'n are found in Beil

Refs: 1) Beil 15, 454, (127) & [177]

2) Beil 15, 460, (129) & [182] 3) Beil 15, 468, (130) & [183]

Hydrazinodinitrobenzene or Dinitrophenylhydrazine, $(O_2N)_2C_6H_3 \cdot NH \cdot NH_2$; mw 198.14, N 28.28%; OB to CO_2 -88.8%. Two isomers are known:

2,4-Dinitrophenylhydrazine, blsh-red crystals (from alc), mp 194° , dec at 198° ; insol in w; sol in alc & ethyl acetate, sl sol in ether, benz & chl; was prep'd in 1894 by Purgotti and in 1912 by Green & Rowe by heating on a w bath 4-Chloro-1,3-dinitrobenzene with freshly prep'd alc hydrazine hydrate. Some of its salts are expl (Refs 1, 4, 5 & 6)

2,6-Dinitrophenylhydrazine, orn-red ndls (from alc), mp 145° ; insol in w; sol in hot w; sl sol in eth, benz & chl; was prep'd from 2-chloro-1,3-dinitrobenzene & hydrazine hydrate in dil alc (Refs 2, 3, 5 & 6)

Refs: 1) Beil 15, 489, (146) & [215] 2) Beil 15, (146) & [219] 3) W. Borsche & D. Rantscheff, Ann 379, 171 (1911) 4) A.G. Green & F.M. Rowe, JCS 101, 2448 (1912) 4a) M. Giua, Gazz 52 (I), 346-49 (1922) 5) A.H. Blatt, Ed, Organic Syntheses Coll Vol 2 (1943), pp 228-29 (C.F.H. Allen) 6) Clark, Hydrazine (1953), p 32 (Prepn), 32, 92 & 97 (Uses)

N-Nitroso-N-[2,4-dinitrophenyl]-hydrazine, $(O_2N)_2C_6H_3 \cdot N(NO)NH_2$; mw 227.14, N 30.84%; yel lfths or prisms (from eth), mp 72° , bp--deflagrates; was prep'd from 2,4-dinitrophenylhydrazine & $NaNO_2$ in a soln of HCl, water & alc (Refs 1 & 2)

Refs: 1) Beil 15, 493 2) T. Curtius & (?) Dedichen, JPrktChem[2] 50, 263 (1894)

Hydrazinotrinitrobenzene; 2,4,6-Trinitrophenylhydrazine or Picrylhydrazine,

$(O_2N)_3C_6H_2 \cdot NH \cdot NH_2$; mw 243.14, N 28.81%; red-brn prisms; nearly insol in w, eth, chl, cold alc or benz; sl sol in hot alc; sol in acetic acid; was prep'd from picrylchloride & hydrazine hydrate or acetate in alc. This comp'd is an expl less powerful & less brisant than PA

Refs: 1) Beil 15, 493, (147) & [221]

2) A. Purgotti, Gazz 24 I, 113 (1894)

3) W. Borsche, Ber 54, 1287 (1921); JCS 66 I, 372 (1894) 4) A.H. Blatt, Ed, Organic Syntheses, Coll Vol 2, Wiley, NY (1943), 229

Hydrazinebenzene or Phenylhydrazine Reactions.

Several investigators have studied the reaction betwn Phenylhydrazine and various aromatic & aliphatic compds. The following Refs should be of interest

Refs: 1) F. Kehrman & J. Messinger, Ber 25, 899 (1892) (Studies of reactions betwn Phenylhydrazine & dinitrochlorobenzene) 2) M. Giua, AttiAccadLincei 27 I, 379-82 & 247-52 (1918) & CA 13, 1450, 1586 (1919); GazzChem-Ital 49 II, 146-54 (1919) & CA 14, 1530 (1920) (Reactions betwn Phenylhydrazine and some aromatic nitrocompds contg a labile NO_2 group, such as TNT's, Trinitrobenzoic Acid, Trinitroxylylene, Trinitrocresol & Trinitroanisole were studied. In most cases the formation of nitrohydrazo compds was observed.) 3) R.C. Elderfield, "Explosives from Hydroxy and Amino

Compounds", OSRD 158 (Oct 1941), pp 24-25
 (a) On condensing Phenylhydrazine with 2,4-dinitrochlorobenzene, instead of the expected dinitrohydrazobenzene, 2-phenyl-5'-nitrobenzotriazole,

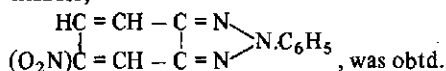

When nitrated, this compd yielded an expl,

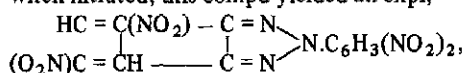

called 2-(2'',4''-Dinitrophenyl)-1',5'-dinitrobenzotriazole. b) Also on condensing Phenylhydrazine with 2,4-dinitrochlorobenzene, followed by refluxing in glacial acetic acid, 2-phenyl-(5'-nitrobenzotriazole)-1-oxide,

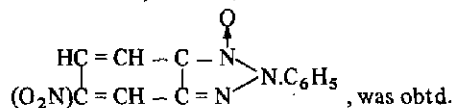

When this compd was nitrated, an expl compd 2-(2'',4''-Dinitrophenyl)-1',5'-dinitrobenzotriazole-1-oxide,

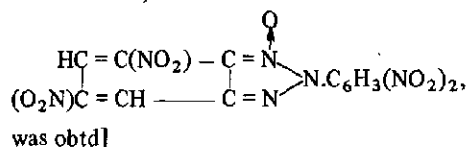

Hydrazino compounds, Analytical Methods for
 Three potentiometric methods of analysis of hydrazine compounds are described:

1) Dissolve sample in H₂O, add concd HCl, cool & titrate until equilibrium is established between 700 & 800 mv. This takes place when the IO₃⁻ is reduced to ICl, losing 4 meq 2) Dissolve in H₂O-H₂SO₄ & titrate to the formation of I⁰ 3) Dissolve in boiling H₂O & keep under nitrogen while cooling. To cold soln add NaOH & titrate to I⁻ end pt. The 3rd method gives low results but is the only possible method for some hydrazino compounds

Ref: W. R. McBride et al, AnalChem 23, 890 (1951) & CA 45, 7463 (1951)

Hydrazinodicarbonic Acid and Derivatives

Hydrazinodicarbonic Acid, HOOC.HN.NH.COOH; mw 88.07, N 31.81%; may be considered as a parent compd of its deriv, although not used to prep it

Hydrazinodicarbonic Acid Diazide or Hydrazo-

dicarbonazide, N₃.OC.HN.NH.CO.N₃; (called Hydrazindicarbonsäurediazid in Ger); mw 170.10, N 65.88%, OB to CO₂ and N₂ -28.2%; ndls (from eth), mp 150-52° with evolution of gas (when heated slowly); explodes without melting, when heated rapidly. May be prepd from hydrazidicarbonhydrazide hydrochloride, H₂NNHCONHNHCONHNH₂·2HCl, and an aqueous solution of NaNO₂. Difficultly sol in cold w & bz; insol in chl f & ligroin; sol in acetone, alcohol & hot ethylene bromide; very sol in eth

It is a primary explosive and is slightly more sensitive to impact than Lead and Silver Azides. It would require 0.25g of this explosive to detonate lg of TNT

Refs: 1) Beil 3, (60) & [102] 2) R. Stollé, Ber, 43, 2468 (1910) (Prepn of hydrazidicarbonhydrazide) 3) W. Kesting, Ber, 57, 1321 (1924) & CA 19, 245 (1925) 4) Clift & Fedoroff, Manual for Expls Labs, Lefax, Phila, Pa, Vol 2 (1943), p H9

Hydrazinoethane. See Ethyl Hydrazine in Vol 6, p E300-R

Hydrazinoethane; 2,2-Dinitro. See 2,2-Dinitroethyl Hydrazine in Vol 6, p E300-R

Hydrazinohydroxyazobenzene and Derivatives

Hydrazinohydroxyazobenzene,

HO.C₆H₄.N:N.C₆H₄.HN.NH₂; mw 228.25, N 24.55%; may be considered as parent compd of its dinitro deriv, although not used to prep it
 Ref: Beil, not found

4,6-Dinitro-3'-hydrazino-4-hydroxyazobenzene

(called Phenol-(4azo3)-[4,6-dinitrophenylhydrazin] or 4,6-Dinitro-3'-hydrazino-4-oxyazobenzol in Ger).

HO.C₆H₄.N:N.C₆H₂(NO₂)₂.NH.NH₂; mw 318.25, N 26.41%; red-brown crystals; sl sol in boiling alc; sol in boiling nitro-benzene. Prepd by reacting 5'-chloro-2',4'-dinitro-4-hydroxy-azobenzene & hydrazine hydrate in hot alcohol. Decomposes 178-80°

Refs: 1) Beil 16, [262] 2) W. Borsche, Ber 54, 684 (1921)

Hydrazinomethane or Methyl Hydrazine,

$\text{CH}_3\text{HN.NH}_2$; mw 46.07, N 60.81%; hydr flammable liq, sp gr 0.874 at 25°; fr p <80° (Lange), -52.4° (CondChemDict). It can be prep'd by method of Thiele (Refs 1 & 2) consisting of condensing hydrazine with benzaldehyde to give azine, $\text{C}_6\text{H}_5\text{.CH:N.NH}_2$, which is treated with dimethyl sulfate followed by water:

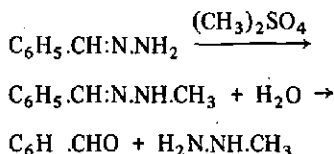

It is used in missile proplnts and as a solvent and intermediate (Ref)

Refs: 1) Beil 4, 546, (560), [957] & [1726]
2) J. Thiele, Ann 376, 239-68 (1910)
3) Clark, Hydrazine (1953), 35 4) CondChem-Dict (1961), 742-L and (1971), 575-R

Hydrazinophenol and Derivatives

4-Hydrazinophenol, $\text{C}_6\text{H}_4(\text{OH}).\text{HN.NH}_2$; mw 124.14, N 22.57%; crystals, mp—unstable. It can be prep'd as hydrochloride salt by heating N-[4-hydroxyphenyl]-hydrazine-N'-sulfonic acid K with alc & HCl; forms other salts

Refs: 1) Beil 15, 596 2) ? Altschul, JPrakt-Chem [2], 57, 202 (1898)

Hydrazinophenol Azide, $\text{N}_3\text{.C}_6\text{H}_3(\text{OH}).\text{HN.NH}_2$; not found in Beil

4,6-Dinitro-3-hydrazinophenol or 4,6-Dinitro-3-hydroxyphenylhydrazine, $(\text{O}_2\text{N})_2\text{C}_6\text{H}_2(\text{OH}).\text{HN.NH}_2$; mw 214.14, N 26.17%, OB -74.6%; fine egg-yellow flocks, resembling yellow HgO when dry; mp 197° (decomp); sol in hot alc (with separation of red-brown spherical granules); sol in warm aq HCl; decomposed by dil NaOH with vigorous foaming. Prep'd by heating 2,5-Dinitro-4-chlorophenol in alcohol with hydrazine hydrate & then acidifying with dil nitric acid

Refs: 1) Beil 15, [274] 2) W. Borsche, Ber 54B, 676 (1921) & CA 15, 2844 (1921)

Trinitrohydrazinophenol, $\text{C}_6\text{H}_3\text{N}_3\text{O}_7$, not found in Beil

Hydrazinopyridine and Derivatives

Hydrazinopyridine, $\text{H}_2\text{N.NH.C}_5\text{H}_4\text{N}$, mw 109.13, N 38.51%. Exists as 2-, 3- & 4-hydrazino isomers (Refs 1 & 2). May be considered as parent comp'd of nitrated derivs, although they were not prep'd from it

Refs: 1) Beil 22, (688) & [487] 2) Beil 22, [488]

Hydrazinopyridine Azide, $\text{C}_5\text{H}_6\text{N}_6$, not found in Beil

Nitrohydrazinopyridine, $\text{C}_5\text{H}_6\text{N}_4\text{O}_2$; mw 154.13, N 36.35%. Two isomers are known:

5-Nitro-2-hydrazinopyridine,

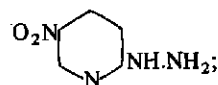

crystals, mp 204-06° (dec); diffc sol in common solvs; sol in alkalies; can be prep'd by treating 6-chloro-3-nitropyridine with hydrazine hydrate or alcoholic hydrazine soln under cooling (Ref 1); from 5-nitro-2-pyridine, sulfonic acid & the appropriate amine (Ref 3), or by boiling 2-methoxy-5-nitropyridine with hydrazine (Ref 4)

3-Nitro-4-hydrazinopyridine,

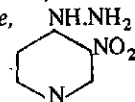

red ndls (from alc), mp 200°; insol in eth & benz; sl sol in w & alc; v sol in acids giving a yel colored soln; was prep'd by treating hydrazine hydrate with 4-chloro-3-nitropyridine in a little alc heated on a water bath (Ref 2)

Refs: 1) Beil 22, [487] 2) Beil 22, [489]
3) A. Mangini & M. Collona, Gazz 73, 313 (1943) & CA 41, 1225 (1947) 4) M. Collona & D. Dal Monte Casoni, BollSciFacoltaChimInd-UnivBologna 5, 35 (1944-47) & CA 44, 3494 (1950)

Dinitro, $\text{C}_5\text{H}_5\text{N}_5\text{O}_4$, and **Trinitrohydrazinopyridine**, $\text{C}_5\text{H}_4\text{N}_6\text{O}_6$, were not found in Beil

5-Hydrazino-tetrazole (Tetrazyl-5-hydrazine) ([Tetrazolyl-(5)]-hydrazin, Tetrazolonhydrazon in German);

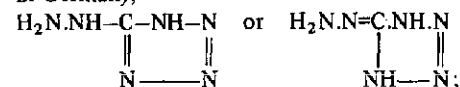

mw 100.09, N 83.97%; crystals (from w), mp 199° (dec), bp—decomp explosively on heating above mp; sl sol in cold w; sol in alkalis & ammonia; insol in alc, eth & benz. It was first prepd by Thiele et al (Refs 1 & 2) by reduction of tetrazolodiazonium chloride with stannous chloride in the presence of HCl. Other methods of prepn are given in Refs 1, 2 & 5

Refs: 1) Beil 26, 405 2) J. Thiele et al, Ann 273, 155 (1893); 287, 235 (1895) and 303, 62 (1898) 3) E. Lieber & G.B.L. Smith, Chem-Revs 25, 240 (1939) 4) F.R. Benson, Chem-Revs 41, 8 (1947) 5) F.L. Scott et al, JAppl-Chem 2, 369 (1952) & CA 48, 3354 (1954) 6) No more recent refs found in CA

Hydrazinotoluene and Derivatives

Hydrazinotoluene or Tolyhydrazine,

$H_3C.C_6H_4.NH.NH_2$; mw 122.17, N 22.93%.

There are three isomers, ortho-, meta-, and para-tolyhydrazines

Refs: 1) Beil 15, 496, (147) & [222] (ortho) 2) Beil 15, 506, (152) & [229] (meta) 3) Beil 15, 510, (153) & [233] (para)

Hydrazinotoluene Azide, $C_7H_9N_5$, not found in Beil

Mononitrohydrazinotoluene, $C_7H_9N_3O_2$; mw 167.17, N 25.14%. Two isomers are found in Beil:

5-Nitro-2-hydrazinotoluene, lt golden-yel or orn-yel ndls with a violet tinge (from alc), mp 179–80°; diffc sol in hot alc & xylene; was prepd by heating the K salt of N-[4-Nitro-2-methyl-phenyl]-hydrazine-N,N'-disulfonic acid with concd HCl (Refs 1 & 3)

3-Nitro-4-hydrazinotoluene, dk-red ndls (from eth), mp 110–11°; v sol in acet; sol in eth, chl & benz; sl sol in petr eth; was prepd by diazotizing 2-nitro-4-methylaniline with Zn chloride & HCl. Its Hydrochloride salt, $C_7H_9N_3O_2.HCl$, orn-red ndls or plates (from w) dec at 190–91° (Refs 2 & 4)

Refs: 1) Beil 15, 505 2) Beil 15, 530 3) Bamberger, Ber 30, 516 (1893) 4) Pope & Hird, JChemSoc 79, 1142 (1901)

Dinitrohydrazinotoluene, $C_7H_8N_4O_4$; mw 212.17, N 26.41%. Five isomers are described

in Beil:

3,5-Dinitro-2-hydrazinotoluene, orn ndls (from alc), mp 169° (dec); v sl sol in alc; was prepd from 2,3,5-Trinitrotoluene & hydrazine hydrate in alc (Refs 1 & 7)

2,4-Dinitro-3-hydrazinotoluene, red prisms (from alc or benz), mp 170°; sol in warm 10% HCl; was prepd by warming 2,3,4-Trinitrotoluene with hydrazine hydrate in dil alc and cooling the soln (Refs 2 & 7)

2,6-Dinitro-3-hydrazinotoluene, solid, mp—not reported; was prepd by warming 3-chloro-2,6-dinitrotoluene with hydrazine hydrate in dil alc on a water bath (Refs 3 & 7)

4,6-Dinitro-3-hydrazinotoluene, yel-red crystals (from alc), mp 194–95° (dec); sol in alc, benz & chl; was prepd by treating 2,4,5-Trinitrotoluene with hydrazine hydrate in alc (Refs 4 & 6)

3,5-Dinitro-4-hydrazinotoluene, copper-colored tablets (from alc), mp 139°; was prepd by heating an alcoholic soln of 3,4,5-Trinitrotoluene with alc hydrazine hydrate soln (Refs 5 & 7)

Other props are given in Refs

Refs: 1) Beil 15, [229] 2) Beil 15, [231] 3) Beil 15, (152) 4) Beil 15, (115), [232] & [676] 5) Beil 15, [244] 6) M. Giua, Gazz 49, II, 171 (1919); 53, 849 (1923) 7) O.L. Brady & J.H. Bowman, JChemSoc 119, 896, 899 & 900 (1921)

2,4,6-Trinitro-3-hydrazinotoluene,

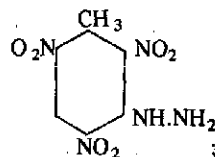

mw 257.17, N 27.24%; golden-yel plitts (from alc), mp 176° (dec); sol in alc, benz, chl & acet; sol in alkalis giving a red-brn soln; sl sol in petr eth; was prepd by treating 2,4,6-Trinitro-3-methoxytoluene with hydrazine hydrate in alc (Refs 1 & 2)

Refs: 1) Beil 15, (153) 2) M. Giua, Gazz 49 II, 174 (1919)

3-Hydrazine-1,2,4-triazole,

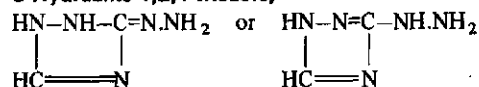

mw 99.10, N 70.68%; no props given; was prepd by reduction of 5-nitrosimino-1,2,4-triazolin-3-carboxylic acid with Zn chloride & HCl at -3° . Its *Hydrochloride salt*, $C_2H_5N_5 \cdot HCl$, ndls, dec at 224° . Also form a *Picrate salt*, $C_2H_5N_5 \cdot C_6H_3N_3O_7$, lt-yel ndls (from w), mp 165° (Refs 1 & 2)

Refs: 1) Beil 26, 138 2) W. Manchot & ? Noll, Ann 343, 18 (1905)

Hydrazobenzene and Derivatives. See N,N'-Diphenylhydrazine and Derivatives in Vol 5 of Encycl, pp D1462-R to D1463-L and the following derivs not described:

2,4,2'-Trinitrohydrazobenzene,

$(O_2N)_2C_6H_3 \cdot NH \cdot NH \cdot C_6H_4(NO_2)$; mw 319.23, N 21.94%; pale yellow needles (from HAc), mp 220° , puffs off on strong heating; sol in acetone, chl_f, ligroin & Et acetate. Prepd from 2-nitrophenylhydrazine & 4-chloro-1,3-dinitrobenzene

Refs: 1) Beil 15, 490 2) A. Werner & ? Stiasny, Ber 32, 3281 (1899)

2,4,3'-Trinitrohydrazobenzene,

$(O_2N)_2C_6H_3 \cdot NH \cdot NH \cdot C_6H_4(NO_2)$; no props given; was prepd by heating 3-nitrophenylbenzene (2 mols) with 4-chloro-1,3-dinitrobenzene at $100-105^{\circ}$

Refs: 1) Beil 15, 490 2) A. Werner & ? Stiasny, Ber 32, 3280 (1899)

2,4,4'-Trinitrohydrazobenzene,

$(O_2N)_2C_6H_3 \cdot NH \cdot NH \cdot C_6H_4(NO_2)$; lt-yel ndls (from Nitrobenz), mp $212-13^{\circ}$; sol in glac acet ac & acet; sl sol in hot alc; almost insol in benz & chl_f; insol in petr eth; was prepd by heating 2 mols 4-nitrophenylhydrazine with 1 mol 4-chloro-1,3-dinitrobenzene at $100-05^{\circ}$ (Refs 1 & 2)

Refs: 1) Beil 15, 490 2) A. Werner & ? Stiasny, Ber 32, 3266, 3277 (1899)

2,4,6-Trinitrohydrazobenzene (called N-Phenyl-N'[2,4,6-trinitrophenyl]-hydrazin in Ger).

$C_6H_5NH \cdot NH \cdot C_6H_2(NO_2)_3$; mw 319.2, N 21.9%; dark red prisms (from HAc or acetone); mp 181° ; decomp on rapid heating & puffs off in a flame; sl sol in alc or chl_f; somewhat sol in acetone. Prepd from phenylhydrazine & picrylchloride (Refs 1 & 3) or trinitroanisole & phenylhydrazine in abs EtOH (Ref 2). It may be considered to be a mild explosive

Refs: 1) Beil 15, 493 & (147) 2) M. Giua & F. Cherchi, GazzChimItal 49 (2), 152 (1919) & CA 14, 1532 (1920) 3) R. Andrisano & D. Dal Monte Casoni, BollSciFacoltaChimInd Bologna (1) (1943) & CA 41, 723 (1947)

4) No further refs were found in CA thru 1971

Hydrazobisformamidine or Hydrazodicarbonamidine. See Biguanidine in Vol 2, p B115-L

5,5'-Hydrazo-bis-1H-Tetrazole. See Bis (5-Tetrazole)-hydrazine in Vol 2 of Encycl, p B157-R and the following addnl refs

Refs: 1) F.R. Benson, ChemRevs 41, 8 (1947) 2) O.E. Sheffield, "Long Range Basic Research Leading to the Development of Ideal Propellants. Compounds of High Nitrogen Content in Propellant Powders," PATR 1694 (May 1948) 3) W.S. McEwan & M.W. Rigg, JACS 73, 4725 (1951) & CA 46, 4350 (1951) (give ΔH_f°)

Hydrazodicarbonazide. See Hydrazinodicarbonic Acid Diazide

Hydrazoic Acid. See under Azides in Vol 1, p A537-42

Hydrazotates. See Azides

5,5'-Hydrazotetrazole. Compd investigated for use as a primary explosive. Impact sensitivity was found unsatisfactory. Some pertinent properties: Impact sensitivity 32 cms, Vac Stab, 1.7 ml of gas/48 hrs/100°C, Hot Bar Ign temp $239^{\circ}C$
Ref: Francis Taylor, NAVORD Rept 2800, Primary Explosives Research, Naval Ord Lab, White Oaks, Md (1953)
NOTE: See also 5,5'-Hydrazo-bis-tetrazole in Vol 2 of Encycl, p B157-R

Hydrazulmin. $C_6H_6N_6$, mw 162.16, N 51.83%, soot-black shiny leaflets. Prepd from cyanogen & dry ammonia. Decomposes on heating to give paracyanogen; decomp in water
Ref: Beil 2, 553

Hydrides. Both ionic & covalent compounds of H with another element usually metallic. These will generally be described under the "other" element eg Al-hydride in Vol 1, p A145 & B-hydrides in Vol 2, pp B253-56. However certain

props common to the hydrides follow below:

Toxicity: Variable. The hydrides of phosphorus, arsenic, sulfur, selenium, tellurium and boron which are highly toxic, produce local irritation and destroy red blood cells. They are particularly dangerous because of their volatility and ease of entry into the body. The hydrides of the alkali metals, alkaline earths, aluminum, zirconium and titanium react with moisture to evolve hydrogen and leave behind the hydroxide of the metallic element. This hydroxide is usually caustic. See also sodium hydroxide

Hydrides, metallic, primary type:

This group includes the hydrides of calcium, lithium, magnesium, potassium, sodium and strontium. In the presence of moisture they are readily converted to hydroxides which are highly irritating to the skin by caustic and thermal action. Similar effects can occur on contact with eyes and respiratory mucous membranes

Fire Hazard: The volatile hydrides are flammable, some spontaneously so in air. All hydrides react violently on contact with powerful oxidizing agents. When heated or on contact with moisture or acids an exothermic reaction evolving hydrogen occurs. Often enough heat is evolved to cause ignition. Hydrides require special handling instructions which should be obtained from the manufacturers

Explosion Hazard: The volatile hydrides (such as hydrides of boron, arsenic, phosphorus, selenium, tellurium) form explosive mixtures with air. The nonvolatile hydrides (such as sodium, lithium, calcium) readily liberate hydrogen when heated or on contact with moisture or acids. Furthermore, hydrides form dust clouds which can explode due to contact with flames, sparks, heat or oxidizers

Disaster Hazard: Highly dangerous; when heated, they can ignite at once or liberate hydrogen:

they react with moisture or acids to evolve heat and hydrogen; on contact with powerful oxidizers violent reactions can occur. (Ref 2)

Metal hydrides (Al, Li, LiAl, etc) in Me ether solns should not be evaporated because of the danger of explosions (Ref 1). Similarly the use of LiAl-hydride is not recommended for drying Me ethers (Ref 2)

Refs: 1) G. Barbaras et al JACS 70, 877 (1948) & CA 42, 3572 (1948) 2) R. M. Adams C & EN

31, 2334 (1953) & CA 47, 8371 (1953) 3)
Sax, 3rd edit (1968), p 820

Hydrin is the reaction product of a polyhydric alcohol and an inorganic acid, eg α chlorhydrin is formed from $\text{HOCH}_2\text{CH}(\text{OH})\text{CH}_2\text{OH} + \text{HCl} = \text{HOCH}_2\text{CH}(\text{OH})\text{CH}_2\text{Cl} + \text{H}_2\text{O}$

Ref: Hackh's (1944), p 418-L

Hydrinwestfalite. A German explosive containing DNT

Ref: Colver (1918), p 167

Hydrobel. Brit Expls used for Pulsed Infusion Shot firings: NG+NGc 37.9-40.9, NC 1.0-3.0, woodmeal 0.6-1.6, AN 19.0-21.0, NaCl 26.1-28.1, Barytes 8.7-10.7, chalk 0.1-1.0, diammonium phosphate 0.1-0.8, Acid Magenta 0.001-0.05, AS No 2 (optional) 0.001-0.01%; d 1.7; vel of deton 5000 m/sec; temp of expln—not given. To initiate hydrobel chges under high hydrostatic pressure, it is necessary to use a specially designed Cu tube & submarine electric detonators
Ref: McAdam & Westwater "Mining Explosives," Oliver & Boyd, Edinburgh (1958), p 109

NOTE: The compn of AS No 2 is not reported

Hydrocarbon. $\text{C}_{20}\text{H}_{24}$; mw 264.39, crystals, mp 38° , bp 330° . Was prepd by Puranen & Ehrnrooth from cymene by treating it at low temperature with a solution of nitrosylsulfuric acid in concd H_2SO_4 , who proposed it as a starting material for preparation of various explosives
Ref: N. Puranen & E. Ehrnrooth, GerP 611461 (1935) & CA 29, 4020 (1935)

Hydrocarbons. Compounds consisting of carbon and hydrogen. The number of such compounds is immense and they may be classified into: "aliphatic" (alicyclic) and "aromatic" (cyclic) compounds. In the former class, the principal carbon atoms are arranged in chains, while in the latter class they are arranged in one or several rings. Hydrocarbons may also be divided into "saturated"—in which all four valences of C are satisfied, and "unsaturated"—in which there are one or more double or triple bonds between carbon atoms

Many hydrocarbons furnish explosive nitrates or nitrocompounds on nitration. (See under individual compounds)

The literature on hydrocarbons is overwhelmingly voluminous. Only three standard references are listed below:

Refs: 1) Beil original, & 1st, 2nd, 3rd & 4th Supplements 2) G. Egloff "Physical Constants of Hydrocarbons," Reinhold, NY (1939-47) in five volumes & ACS Monograph 78 3) F. D. Rossini et al "Hydrocarbons from Petroleum" Reinhold, NY (1953) ACS Monograph 121

Hydrocarbons As Rocket Fuels or Explosives.

Liquid methane & other hydrocarbons are considered as propellant fuels (Ref 1). Nitrogen tetroxide and hydrocarbons (kerosine) are claimed as a blasting explosive (Ref 2)

Refs: 1) J. D. Clark, *Ordnance* 36, 661 (1952) 2) D. H. Ross & T. J. McGonigle, *USP* 2,759,418 (1956) & *CA* 51, 719 (1956)

Hydrocellulose. $C_{12}H_{22}O_{11}$, mw 342.30. The term has been employed since about 1880 to designate a cellulose which has been weakened or tendered as the result of treatment with acids. It retains water strongly. Hydrocellulose is not a single substance but a mixture of hydrolyzed products less complex than cellulose itself and more or less related to it and to glucose (Refs 4 & 6)

Hydrocellulose differs from hydrated cellulose in its properties (Ref 3). According to Stettbacher (Ref 5) hydrocellulose lies between the hydrated cellulose and oxycellulose. Its use as a flash reducer in a propellant has been claimed by C.R. Franklin in *USP* 1564549 (1925) & *CA* 20, 505 (1926). Accordg to CIOS Rept 31-68 (1945), pp 6-7, hydrocellulose was used during WWII by Germans in some rocket propellants, presumably to improve their burning characteristics. For instance the so-called Ammon-pulver contained 5% hydrocellulose and the EP (Einheitspulver) contained about 3%. Hydrocellulose was also used in some rocket propellants to increase the rate of burning at low temperature

Note: Their Einheitspulver Standard (or Unit) Propellant was "G" Pulver (qv), which contd 3% hydrocellulose & 1.5% K-nitrate. Its props are given in *PATR* 2510 (1958), p Ger 190-R

Hydrocellulose can be nitrated, forming an explosive (Refs 2 & 5). Hydrocellulose is claimed to be $C_{24}H_{40}O_{20}$ mw 648.56 by Tavernier

(Ref 7), who gives $(Q_f)_v = 1400$ cal/g & $(Q_f)_p = 1428$ cal/g

Hydrocellulose Nitrate or Nitrohydrocellulose.

A substance resembling NC in its properties (but slightly more sensitive to shock), was prepd by Cross and Bevan and Beadle by nitration of 1 part of dry hydrocellulose by means of 3 parts of nitric acid and 9 parts of sulfuric acid (Refs 1, p 25, & 2, p 556); products corresponding to hexa- and heptanitrohydrocelluloses are formed. Its use in explosives was recommended by Luck, Durnford and Ungania (Ref 2, p. 557).

Traulz (Ref 2, p 199) proposed using detonators charged with a gel prepd by impregnating 1 part of Nitrohydrocellulose with 1 to 3 parts of NG. Such detonators could be used underwater

Refs: 1) P. Vieille, *MP* 2, 21 (1884) (Preparation and properties) 2) Daniel (1902) 199, pp 381 & 556-7 3) Marshall, I, (1917), 153 4) Marsh & Wood, *Cellulose* (1945), p 222 5) Stettbacher (1933), 124 6) C. Dorée, "The Methods of Cellulose Chemistry", Chapman & Hall, London (1947), pp 144-77 7) P. Tavernier, *MP* 38, 305 & 308 (1956) & *CA* 51, 15952 (1957)

Hydrochloric Acid or Muriatic Acid. See Hydrogen Chloride, Anhydrous and Hydrochloric Acid

Hydrocinnamic Acid and Derivatives

Hydrocinnamic Acid or 3-Phenylpropionic Acid, $C_6H_5CH_2CH_2COOH$; mw 150.17, crystals, mp 46° ; sl sol in w; sol in alc or eth. Prepd by the reduction of cinnamic acid with Na-amalgam

α -Azidohydrocinnamic Acid or α -Azido- β -phenylpropionic Acid (called \ominus -Amido-Hydrozimtsäure in Ger), $C_6H_5 \cdot CH_2 \cdot CH(N_3) \cdot COOH$; mw 191.19, N 21.98%; plates, mp $24-7^\circ$. Its *Silver salt*, $AgC_9H_8N_3O_2$, cryst (from w), explodes mildly on heating; the *Ammonium salt*, white cryst, burns quietly on contact with a flame

Refs: 1) Beil 8, (205-6) 2) A. Darapsky & H. Berger, *JPraktChem* 96, 320-1 (1917); *JCS* 114 I, 507-8 (1918) & *CA* 13, 1304-5 (1919) 3) No further refs found in *CA* thru 1971

Hydrocinnamic Acid Azide (called Hydrozimmt-säure-Azid in Ger). $C_6H_5CH_2CH_2CON_3$; mw 175.19, N 23.99%, powdery crystals (from eth); insol in w; sol in alc or eth. Puffs off on heating. Prepd by reacting hydrocinnamic acid hydrazide in HCl with Na-nitrite
 Refs: 1) Beil 9, 513 2) No further refs found in CA thru 1971

Hydrocyanic Acid or Hydrogen Cyanide (Formonitrile or Prussic Acid), HCN, mw 27.03, N 51.82%, OB to CO_2 -14.9%; highly poisonous, colorless liquid or gas; d 0.697 at 18° , fr p -13.3° , bp $+25.6^\circ$, fl p $0^\circ F$, auto ignition temp $100^\circ F$. Very sol in w, alc & eth. Exists in two isomers, H.C:N and H.N:C. This fact was first stated by Enklaar and then confirmed by Wöhler and Roth, who also examined the explosive properties of HCN (Ref 3). May be prepd by treating a cyanide, such as calcium cyanide, with dilute sulfuric acid; also catalytically from hydrocarbons and ammonia (Ref 6). HCN is present in the products of detonation of various explosives. The dissociation energy for H-CN is 129 ± 3 kcal/mole (Ref 9). It is an explosive which requires a stronger initiation than that supplied by a No 8 cap for its detonation. For instance, 3g of HCN, cooled to 0° , may be detonated with a cap containing 0.4g of Lead Azide and 1.25g of PETN. If the detonation takes place in a lead block 10 x 10 cm, the block is generally split in two. The explosion of HCN is favored by its preliminary polymerization by alkalis (Ref 3). It may even polymerize explosively (Ref 12). Presence of NaOH, but not water, and increasing temp were found to favor violent HCN polymerization. The heat of polym is 377 cal/g (Ref 8). In the presence of NO & argon, HCN explodes when heated in a reflected shock wave to give CN, NCN, NH & OH radicals during the pre-explosion induction period. The reaction $NO+HCN=CN+HNO$ is claimed to be rate-controlling (Ref 13)

The combustion of HCN has been studied extensively. Ignition limits in air are ca 42.5 & 8 vol%. In the presence of CO_2 these limits coalesce for the mixture CO_2 36 vol% & HCN 12 vol% (Ref 6). Burning velocity, flame temp & thickness of reaction zone for HCN/ O_2 / N_2 mixtures have been measured. The overall acti-

vation energy for HCN/ O_2 flames is claimed to be 42-44 kcal/mole (Ref 11). HCN has also been considered as a rocket fuel. Its combustion enthalpy and specific impulse are high & even its toxicity is relatively low when compared with diborane & hydrazine (Ref 10)

Some of its salts are also explosive, for example, $Hg(CN)_2$ and $Hg(CN)_2 \cdot HgO$. Its methyl salt is explosive when in the CH_3NC form, while the CH_3CN form is not an explosive

HCN is used in the manufacture of polymers & fumigants (Ref 14)

NOTE: Accdgd to Blatt, OSRD 2014 (1944), HCN is an expl of low sensitivity to initiation because it cannot be detonated by No 8 cap. In order to detn its power by Trauzl Test, a 3g sample in lead block 10x10cm, cooled to 0° was detonated with 0.4g LA+1.25g PETN initiator. It gave an expansion of 95-100cc and this usually split the block
 Refs: 1) Beil, 2, 29 (22) & [37] 2) Ullmann, 3, (1926), 470-510 3) L. Wöhler & J. Roth, ChemZtg, 50, 761-3, 781-2 & CA 21, 496 (1927) 4) Marshall, 3, (1932), 137 5) W.M. Latimer & J.H. Hildebrand, "Reference Book of Inorganic Chemistry," MacMillan, NY, (1940) p 284 6) K.J. McCallum & H.M. Trainor, Canad JRes 27B, 412 (1949) 7) GerPatApplNo B20028 ((12k, 9) (April 17, 1952) 8) E.H. Gause & P. D. Montgomery, JChemEngData 5, 351 (1960) & CA 55, 18112 (1961) 9) H.T. Knight & J.P. Rink, JChemPhys 35, 199 (1961) & CA 56, 2008 (1962) 10) A. Beckers, Waerme 70(3), 96 (1964) & CA 61, 14454 (1964) 11) M. Ailliet & A. Van Tiggelen, BullSocChemBelg, 77, 433 (1968) & CA 70, 3194 (1969) 12) Sax, 3rd Edit (1968), p 822 13) L.J. Drummond, CombustSciTechnol 1 (6) 415 (1970) & CA 73, 68154 (1970) 14) CondChemDict, 8th Edit (1971), p 453

Hydrodynamics. Flow systems are governed by the laws of *hydrodynamics*. How these laws relate to detonation was discussed in Vol 4, pp D602-22. Recent books and reviews on this subject are listed below:

- 1) H.R. Vallentine, "Applied Hydrodynamics", Butterworth Scientific Publications, London (1959)
- 2) D.H. Wilson, "Hydrodynamics", E. Arnold, London (1959)

- 3) S. Chandrasekhar, "Hydrodynamic & Hydro-magnetic Stability", Clarendon Press, London (1961)
- 4) G.H.A. Cole, "Fluid Dynamics", John Wiley, NY (1962)
- 5) V.G. Levich, "Physicochemical Hydrodynamics", Prentice-Hall, Englewood Cliffs, NJ (1962)
- 6) C. Truesdell, "Fluid Dynamics II", Vol VIII of Encycl of Physics, ed S. Fluegge, B.H. Blackwell, Oxford (1963)
- 7) R.H. Sabersky & A.J. Acosta, "Fluid Flow", Macmillan, NY (1964)
- 8) M. Weintraub "Chemical Engineering Aspects of Fluid Dynamics." Review with 252 references. *IndEngChem* **56** (4), 43 (1964) & *CA* **60**, 15453 (1964)
- 9) B. Alder et al, Eds, "Fundamental Methods in Hydrodynamics" (Methods in Computational Physics, Vol 3), Academic Press, NY (1964)
- 10) J. Happel & H. Brenner, "Low Reynolds Number Hydrodynamics", Prentice-Hall, Englewood Cliffs, NJ (1965)
- 11) R.J. Seeger & G. Temple, Eds, "Research Frontiers in Fluid Dynamics", Interscience, NY (1965)
- 12) M.A.T. Cocquerel "Unit Operations, Heat Transfer, Fluid Flow." Review with 73 refs. *ReptProgrApplChem* **50**, 117 (1965) & *CA* **66**, 39243 (1967)
- 13) J. C. Pearson "Hydrodynamic Elastic Plastic Theory and Plane Shock Waves in Metals. I. Theory." Title of the paper in 4thONRSympDeton (1965), p 289 (Abstract) and of *PATR* **3464** (1966)
- 14) L. G. Loitsyanskii "Mechanics of Liquids & Gases", Pergamon Press, London (1966)
- 15) Ya. B. Zel'dovich & Yu. P. Raizer "Physics of Shock Waves & High-Temperature Hydrodynamic Phenomena" 2nd Ed Moscow, Nauka (1966)
- 16) S. I. Pai et al, Eds, "Dynamics of Fluids & Plasmas", Academic Press, NY (1966)
- 17) R.H.F. Pao, "Fluid Dynamics", Merrill, Columbus (1967)
- 18) R. A. Strehlow "Detonation & the Hydrodynamics of Reactive Shock Waves." Review of recent work. *ACS, DivFuelChemPreprints*, **11**, 1 (1967) & *CA* **70**, 98391 (1969)
- 19) W. N. Gill et al "Fluid Dynamics." Review with 1065 refs. *IndEngChem* **59**, 69 (1967) & *CA* **68** 51292 (1968)
- 20) W. N. Gill et al "Fluid Dynamics." Critical

review of the 1967 fluid dynamics literature. *IndEngChem* **61**, 41 (1969) & *CA* **70**, 69515 (1969)

21) W. N. Gill et al "Fluid Dynamics." Review of literature for 1968 with 791 refs. *IndEngChem* **62**, 49 (1970) & *CA* **72** 134564 (1970)

22) W. N. Gill et al "Fluid Dynamics." Review for 1969. *IndEngChem* **62**, 108 (1970) & *CA* **74**, 55600 (1971)

Hydrodynamic Detonation Velocity. Same as Ideal Detonation Velocity, briefly described in Vol 4 of Encycl, p D630-R

Hydrodynamic Theories of Detonation. See Vol 4 of Encycl, p D610-L

Hydrofluoric Acid or Fluorhydric Acid. See Hydrogen Fluoride, Anhydrous and Hydrofluoric Acid in this Vol

Hydrofluosilicic Acid. See Fluorosilicic Acid in Vol 6 of Encycl, p F141-R

Hydrogen, H, at wt 1.008. The lightest element; usually exists as a molecule (H_2) of mw 2.016 in the form of colorless, highly flammable gas; sp gr of gas 0.06948 (Air 1.0); and of liq 0.0709 at -252.7° ; fr p -259.18° ; bp -252.77° ; autoignition temp $1085^\circ F$; low expln limit 4.1% by vol, upper expln limit 74.2%; very sl sol in w, alc or eih. It can be prepd by the following methods: a) By the action of steam on natural gas at high temperatures, and subsequent purification b) By treatment of water gas with steam and absorbtion of the carbon dioxide c) Dissociation of ammonia d) Thermal decomposition of hydrocarbons e) Catalytic reforming of petroleum f) By reaction of iron and steam g) Catalytic reaction of methanol & steam and h) By electrolysis of water (Ref 2, p 587-R)

Accdg to Ref 2, p 588-L, the molecular hydrogen exists in two varieties: ortho and para, named accdg to their nuclear spin types. Ortho molecules have a parallel spin, para an antiparallel spin. By cooling to liquid air temp and using a catalyst, the normal equilibrium of three ortho to one para molecules is displaced and para- H_2 may be isolated. Para type of H_2 is preferred for liquid fuels

Liquid hydrogen is used in rocket fuels, while hydrogen gas can be used for the following purposes: production of synthetic ammonia and methanol; hydrogenation of org materials such as oils, phenol or naphthalene; reducing agent for organic synthesis; reduction of metallic ores; reducing atmospheres to prevent oxidation; as oxyhydrogen flame for high temps; for atomic hydrogen welding; making hydrochloric and hydrobromic acids; for filling small balloons, etc. It was formerly used in Europe for inflation of passenger-carrying balloons and for observation and barrage balloons (during WWII). Its use in dirigibles was discontinued after disastrous fire of Ger dirigible, "Hindenburg". Hydrogen has not been used for inflation of US dirigibles or balloons because the non-combustible, lighter than air helium is readily available

Note: The explosion and combustion properties of hydrogen mixtures are described as a separate item

Refs: 1) Gmelins Hndb (1936), not found
2) CondChemDict (1961), pp 587-R & 588-L
3) Kirk & Othmer, Vol 11 (1966), pp 338-79 by R.M. Reed 4) Sax (1968), p 823
5) CondChemDict (1971), p 454-L

Hydrogen Bomb. See under **Atomic Bomb** in Vol 1, A499-L

Hydrogen bond. An attractive force, or bridge occurring in polar compounds such as water, in which a hydrogen atom of one molecule is attracted to two unshared electrons of another. The hydrogen atom is the positive end of one polar molecule and forms a linkage with the electronegative end of another such molecule. In the formula below, the hydrogen atom in the center is the "bridge":

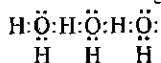

Hydrogen bonds are only one-tenth to one-thirtieth as strong as covalent bonds, but they have pronounced effects on the properties of substances in which they occur, especially as regards melting and boiling points and crystal structure. They are found in compounds containing such strongly electronegative atoms as nitrogen, oxygen and fluorine. They play an important part in the bonding of cellulosic compounds, eg, in the paper industry

Refs: 1) L. Pauling, "The Nature of the Chemical Bond" Cornell Press (1960) 2) G. C. Pimentel & A. L. McClellan "The Hydrogen Bond" Reinhold (1960) 3) CondChemDict (8th Edit 1971), p 455

Hydrogen Bonding Concept in Gelatinization of NC. Tests of a number of hydrogen bonding agents dissolved in ether, alcohol or benzene showed that the concept of hydrogen bonding was certainly involved in the mechanism of gelatinization, but that the results were modified by the character of the volatile solvent used

Tests of the best hydrogen bonding agents in ether-alcohol showed the following compds: trimethyl-, trimethyl-, & tributyl phosphates, isophorone, dimethyl acetamide, and dibutyl tartrate were superior to dibutyl phthalate or triacetin in the amts reqd for gelatinization and in the viscosities of the resulting solns

When a major portion of Guncotton was dispersed with acetone-alcohol and the residual portion with one of the above compds, equal weights of the compds were superior to dibutyl phthalate and to triacetin first, with respect to time reqd for complete dispersion and secondly, in producing solns of low viscosity

Ref: A.J. Philips, "The Relation of the Hydrogen Bonding Concept to the Gelatinization of Nitrocellulose," **PATR 1249** (March 1943)

Hydrogen Chloride, Anhydrous and Hydrochloric Acid.

Anhydrous Hydrogen Chloride is a colorless gas, which on liquefaction gives colorless (or sl yellowish) fuming, strongly corrosive liquid; mw 36.47, sp gr of gas at 0° 1.268 (Air); fr p -114.3°; bp -111° (Lange); bp -84.8°; sol in w, alc, eth & benz. It can be prepd by furnace combstn of hydrogen, methane or water-gas, in chlorine or by solvent extraction from hydrochloric acid (aqueous HCl). It is used in reactions where aq HCl is not suitable, such as production of vinyl chloride from acetylene or of alkyl chlorides from olefins (Ref 2, p 256 & Ref 3, p 588-R)

Hydrochloric Acid (known in commerce as *Muriatic Acid*), is a concd aq soln of anhydrous HCl. It is colorless or sl yel, fuming, pungent, liquid, poisonous unless it is very diluted. The commercial product contains 38% HCl and has

sp gr of 1.19. A more concd product of 45.2% HCl listed in Lange (Ref 2), has sp gr 1.48 and freezes at -15.35° . The acid is sol in w & alc. It can be prepd by several methods such as:

a) By-product of chlorination of benz or other hydrocarbons b) By the action of sulfuric acid on common salt; or c) By Hargreaves process which is described in Ref 3, p 585-R

The acid has many uses in chem & metallurgical industries, as indicated on p 586-R of Ref 3

Note: Salts of HCl are called chlorides, many of which are described in Vol 3 of Encycl, pp C236ff

Refs: 1) GmelinsHdb, Syst No 6 (1927), p 86 & Teil B (1968), p 2 2) Lange (1961), 256 3) CondChemDict (1961), pp 585-R & 588-R 4) Kirk & Othmer, Vol 11 (1966), pp 307-37 by W.R. Kleckner & R.C. Sutter 5) US Spec O-H-765B (May 1969) (Inhibited Hydrochloric Acid for Rust Removal) 6) CondChemDict (1971), pp 453 & 455

Hydrogen Fluoride, Anhydrous and Hydrofluoric Acid.

Anhydrous Hydrogen Fluoride, HF, mw 20.01; colorless, corrosive gas which forms at temp below 19.4° , colorless, fuming, corrosive, poisonous liquid, producing painful burns on the skin. It freezes at -83° and its sp gr is 0.988 at 3.6° (Lange). Both gas and liquid consist of associated molecules; the vapor density corresponds to HF only at high temps. Both gas and liquid are very sol in water. Can be prepd by distillation from the product of reaction of Ca fluoride (fluorspar) and sulfuric acid. Used as fluorinating agent in organic and inorganic reactions; production of fluorine and Al fluoride; prepn of hydrofluoric acid; production of fluoroborates, fluorosilicates, etc; as an additive in liquid rocket propellants; and for refining of uranium (Ref 3, p 588-R)

Hydrofluoric Acid is an aqueous soln of hydrogen fluoride of strength up to 70%. These solns are colorless, fuming, corrosive, mobile liquids, producing terrible sores when allowed to touch the skin. Only a moderately strong acid, but unlike other acids will attack glass and any silica-contg substance. Prepd by absorbing in w, HF gas, which is distilled from a mixture of fluorspar (CaF_2) and sulfuric acid; also by dis-

solving HF liquid in w

Lange (Ref 2, p 256) gives aor 35.35% acid, sp gr 1.15, fr p -35° & bp 120°

Hydrofluoric acid is used for polishing, etching & frosting of glass; pickling Cu & other metals; electropolishing of metals; purification of filter paper and cleaning castings (Ref 3, p 587-L)

Refs: 1) Gmelins Hndb, Syst No 5 (1926), p 31 & 5 (1959), p 142 2) Lange (1961), 256 3) CondChemDict (1961), 587-L & 588-R 4) Kirk & Othmer 9 (1966), pp 610-25 by J.F. Gall 5) Sax (1968), 823 6) CondChemDict (1971), pp 454 & 455 7) US Spec O-H-795(2) (July 1957) (Hydrofluoric Acid, Technical Grade) 8) US Military Spec MIL-H-10925A (Dec 1958) (Anhydrous Acid)

Hydrogen Gun. A gun that shoots bullets at a speed of 4 miles per sec (or even faster) was constructed by E. B. Mayfield of the Naval Ordnance Test Station, Inyokern, California. The propellant is liquid hydrogen touched off by an injection of oxygen and the projectiles are smaller than rifle bullets. The prime purpose of this gun is the study of what happens when a projectile moves through air at very high speeds Ref: Anon, Ordn 36, (No 191), 780 (1952)

Hydrogen-ion Concentration (pH) or Potential of Hydrogen. The concentration of H^+ per liter $[\text{H}^+]$ of an aqueous solution. It denotes the true acidity or alkalinity of such solutions, and is expressed by the pH value (potential of hydrogen). This value is the concentration of H^+ in terms of the reciprocal logarithm of the number of gram ions of hydrogen per liter: $\text{pH} = \log_{10} 1/C_{\text{H}} = -\log_{10} C_{\text{H}}$ where C_{H} is effective concentration of hydrogen (molal or normal). Pure water has pH value = 7.0, because one liter dissociates to contain only 10^{-7} g of H^+ . As there is also an equal number of $[\text{OH}^-]$ present, its pOH is also 7, which makes a total $\text{pH} + \text{pOH} = 14$. Accordingly pH values from 0 to 7 indicate an acid solution, pH = 7 indicates neutrality and pH 7 to 14 an alkaline solution.

Hackh's Dictionary, p 422 (Ref 13) gives a table of relation between pH, pOH, Hydrogen-ion concentration (normality) and hydroxyl ion concentration (normality)

pH values may easily be calculated if the value C_H (also denoted as A_{H^+}) is known. For instance, pH of a solution which is 0.0002 molal in hydrogen ion ($C_H = 2 \times 10^{-4}$)

$$\text{pH} = \log_{10} 1/C_H = \log_{10} 1/2 \times 10^{-4} = \log_{10} 5 \times 10^3 = 3.699$$

Determination of pH values may be done either by electromotive force measurements, by colorimetric methods (indicator papers, or indicator solutions), or by the glass electrode method

Since the pH value is of great importance in many manufacturing processes (including explosives), pH meters are installed to exercise control over the pH (See Refs 5 & 6)

There are also other methods for measuring hydrogen ion concentration, for instance, Sørensen's (psH) unit or the activity coefficient unit (paH), based on emf measurements
Refs: 1) L. Michaelis, "Die Wasserstoffionen-Konzentration," translated from the 2nd German edition (1922) by W.A. Perlzweig and published by Williams & Wilkins, Baltimore (1926) 2) E. Mislowitzer, "Die Bestimmung der Wasserstoffionkonzentration von Flüssigkeiten," J. Springer, Berlin (1927) 3) J. Grant, "Measurements of Hydrogen Ion Concentration," Longmans, Green, London (1930) 4) H.H. Willard & N.H. Furman, "Elementary Quantitative Analysis," Van Nostrand, NY (1935) 5) A. Kufferath, *SS* **31**, 327-30 (1936) & *CA* **31**, 258 (1937) 6) M. Déribéré, *RevGénMatPlastiques* **12**, 356-58, (1936) & *CA* **31**, 2007 (1937) 7) J. Rouvillois, *MémArtifFr* **17**, 773-797 (1938) (Le pH et la stabilité des poudres); *Ibid* **18**, 107-159 (1939) 8) D.A. McInnes, "The Principles of Electrochemistry," Reinhold, NY (1939) 9) I.M. Kolthoff & H. A. Laitinon, "pH and Electro-titrations," J. Wiley, NY (1941) 10) M. Dole, "The Glass Electrode," J. Wiley, NY (1941) (Contains complete bibliography) 11) H.T.S. Britton, "Hydrogen Ions," Chapman & Hall, London (1942) 12) J. Reilly & W.N. Rae, "Physico-chemical Methods," Van Nostrand (1943), v 2, pp 449-500 13) Hackh's *Dict* (1944), p 422; (1969, 333-R 14) A.L. Chaplin, "Applications of Industrial pH Controls", Instruments Pub Co, Pittsburgh, Pa (1950) 15) R.E. Kirk & D.F. Othmer, Ed, "Encyclopedia of Chemical Technology," Interscience, NY, v 7, (1951), pp 711-726; R.G.

Bates & E.R. Smith, *Hydrogen-Ion Concentration* 16) J.E. Ricci, "Hydrogen Ion Concentration," Princeton Univ Press, Princeton, NJ (1952) 17) Catalogs and Bulletins of Beckman, Coleman, Photovolt Corp, Taylor & Co, LaMotte, etc

Hydrogen-ion Concentration Stability Test. See Hansen's Stability Test in this Vol

Hydrogenite. A mixt of Si 25, NaOH 60 & slaked lime 15% which ignites and, on burning, gives 270-370 liters of hydrogen gas per kg
Ref: Hackh's *Dict* (1944), 422-R; (1969), 333-R

Hydrogen Peroxide, Hydrogen Dioxide or T-stuff. HOOH; mw 34.02; colorless or faint blue syrupy liq, fr p -2° , bp 158° (Ref 24), vap press 1mm at 15° & 47mm at 80° , d 1.46; sol in w, alc & eth; insol in pet eth. Thermodyn data: ΔH_f° -44.84 & ΔF_f° -28.2 kcal/mole for liq; ΔH_f° -45.65 kcal/mole for aq H_2O_2 & -31.83 kcal/mole for gaseous H_2O_2 (Ref 6). Bond strengths: H-OOH 89.6 kcal/mole (Ref 18); HO-OH 47.1 kcal/mole (Ref 22)

Preps: a) $BaO_2 + H_2SO_4(aq) = BaSO_4 + H_2O_2$, the aq H_2O_2 is then concentrated by evaporating w under reduced press (Ref 2)

b) Electrolytic oxidation of concd H_2SO_4 with subsequent hydrolysis of the peroxydisulfuric acid (Ref 2)

c) Hydrogen reduction of 2-ethylanthraquinone followed by air oxidation to regenerate the quinone (Ref 25)

Pure H_2O_2 is a very unstable material which decomposes violently above 80° . The decompn $H_2O_2 = H_2O + 1/2O_2$ is catalyzed by many substs such as Ag, MnO_2 , HBr & saliva. Because of this instability, commercial H_2O_2 is usually a water soln—commonly 27.5, 35, 50 & 70%, although solns ranging from 3 to 90% are also available. H_2O_2 solns are stabilized with small amts of acetophenetidin inhibitor (Ref 25)

Toxicology: Pure H_2O_2 , its solutions, vapors and mists are irritating to body tissue. This irritation can vary from mild to severe depending upon the concn of H_2O_2 . For instance solutions of H_2O_2 of 35 wt% and over can easily cause blistering of the skin. Irritation caused by H_2O_2 which does

not subside upon flushing of the affected part with water should be treated by a physician. The eyes are particularly sensitive to irritation by this material (Ref 24)

Uses: Bleaching and deodorizing of textiles, wood pulp, hair, fur, etc; source of organic and inorganic peroxides: pulp and paper industry; plasticizers; rocket fuel; foam rubber; manufacture of glycerol; antichlor; dyeing; electroplating; antiseptic; laboratory reagent; epoxidation; hydroxylation; oxidation and reduction; viscosity control for starch and cellulose derivatives; refining and cleaning metals; bleaching and oxidizing agent in foods; neutralizing agent in wine distillation; seed disinfectant; cosmetics (Ref 25)

Chemistry: In some respects chemistry of H_2O_2 is quite similar to that of H_2NNH_2 or NH_2OH its ammonia system analogs. It is a powerful, but usually slow, oxidizing agent in acid or alkaline solns. It can also act as a reducing agent, eg with MnO_4^- or Ag_2O (Ref 2). On the other hand, H_2O_2 does not tend to form salts or substitute comps (replacement of H) like its ammonia analogs (See Ref 17)

Analytical: Delicate qual tests for H_2O_2 are its reactions with titanate chromate or sulfate in acid to produce the bright blue peroxychromic or bright yellow peroxy titanate acid both of which are sol in ether. Quantitatively H_2O_2 may be detd by its oxidation of I^- and titration of the I_2 (or I_3^-) thus formed (Ref 2)

Explosive and Combustion Props: Pure H_2O_2 is readily detonable and its heat of expln is given as 24.6 kcal/mole. It is claimed that aq solns of less than 94% H_2O_2 will decomp explosively if catalyzed, but will not detonate (Ref 4). More recent studies, however, show that 86% H_2O_2 , at 50° or higher and contained in 1.61 inch ID Al tubes, will detonate at 5600 m/sec when strongly boosted, but not at smaller diameters. A 90.7% soln detonates at 5500 to 6000 m/sec even at 0.5 inch ID and 25°. The gap over which the 90.7% soln will propagate detonation increases with increasing temp (Ref 23)

Mixtures of $(H_2O_2)_{gas}/air$ will not detonate at subatmospheric press. However, a 35 mol% mixt will detonate at 6700 ft/sec at 1 atm. The ignition limit under these conditions is about 30 mol% H_2O_2 vapor (Ref 21)

In an earlier study the min concns of H_2O_2 in a vapor mixt below which powerful external ignition cannot initiate a self-propagating reaction were determined over the pressure ranges of 1 to 6.5 atm. These min concns were found to be 25.6 mole% at 1 atm (or a little lower than above) and 20.7 mole% in the 2-6 atm region (Ref 13)

The explosive limits of H_2O_2 vapor were also determined by using hot wire heated surfaces & catalytic surfaces for ignition. At 1 atm, vapors contg 26.0 mole% or more H_2O_2 could be exploded but only when catalytic surfaces were used. Non-catalytic surfaces had to be pre-heated to 150° to obtain explosions. The lower limits at 200 and at 40mm Hg were 33 and 55 mole% resp. Hydrogen Peroxide explosion is believed to be thermal, involving straight chains only, with the initiating reaction being thermal rupture of the O-O bond (Ref 5)

At lower pressures (200mm), presumably at elevated temps or on catalytic surfaces, the ign limit is 32.5 mol% H_2O_2 . It is not affected by diluting the air with oxygen, nitrogen or He in amounts of 0 to 39 mol%. Decreasing the system volume by packing it with Raschig rings shifts the ign limit to higher Hydrogen Peroxide concns (Ref 10)

Quenching distances & minimum ignition energies of H_2O_2 & H_2O vapor mixtures were studied in a flow system in which liq H_2O_2 & H_2O was fed to a boiler where it completely vaporized and passed through the explosion vessel contg the ignition source & then was condensed (Ref 14). The quenching distances & min spark ignition energies of mixts contg between 35 & 50 mol% H_2O_2 were detd at pressures between 25 & 200 mg of Hg at a temp 9° above the condensation temp. The quenching distances varied between 0.51 & 1.63cm & the ignition energies between 0.53 & 25.5 millijoules, decreasing with increasing H_2O_2 content & pressure. The observed min energy for ign (in millijoules) is related to the quench distance (in cm) by:

$$E_{min} = 3.84 d_q^{3.04}$$

Hydrogen peroxide, pure or aq, is readily detonable when mixed with organic materials. Detonation rates for H_2O_2 mixes with MeOH, EtOH & glycerol were measured by Haeuserler (Ref 7). These rates could be as high as 6700

m/sec for $\text{H}_2\text{O}_2/\text{H}_2\text{O}/\text{EtOH}$. The amount of energy to sustain explosive reaction in $\text{H}_2\text{O}_2/\text{H}_2\text{O}/\text{organic}$ mixes depends not only on the peroxide/organic ratio but also on the water in the mix, the water acting as an energy sink. To a lesser extent explosibility is also affected by sample vol, initial temp, and to a considerable degree by the type of initiation used. Chem changes that occur in a mix can make a powerful explosive out of an apparently non-explosive mixt. Consequently, careful experimentation should precede the mixing or use of mixtures containing Hydrogen Peroxide and organic substances (Ref 15)

In view of these many factors found to influence the explosibility of $\text{H}_2\text{O}_2/\text{H}_2\text{O}/\text{org}$ subst mixes, the simplified approach of Shanley and Perrin (Ref 12), which is based primarily on the enthalpy contents of these mixes, should only be used as a first attempt at determining the explosion hazard of these mixes. Their suggested isoenthalpy line of 0.8kcal/g of mixt defines the experimentally observed expl limits fairly well for initiation by blasting cap. However, their value of 1.2kcal/g for impact initiation suggests that some mixes are safe which in fact were found to be in the explosive range (Ref 15)

The work of Kuchta (Ref 16) confirms that the relative concns of Hydrogen Peroxide/org subs are more important in defining the explosibility of a mixt than the type of org subst used. He points out that detonation can be initiated in certain H_2O_2 purge liquors that may form in commercial production of Hydrogen Peroxide

Hydrogen Peroxide Explosives. Attempts were made in Austria during WWI to use H_2O_2 for the preparation of explosives, but they were not successful. Later, Bamberger and Nussbaum (Ref 1) succeeded in preparing several Hydrogen Peroxide explosives, which were successfully tried in blasting operations. The following explosives were prepared by mixing organic compounds with strong aqueous solutions (about 60% or higher) of peroxide

a) Mixture of H_2O_2 (60% solution) with paraformaldehyde forms a brisant explosive, which may be detonated either by heat or by a blasting cap. This mixture reacts with lead forming a

crystalline compound of high brisance and sensitiveness, melting at about 50°

b) A mixture was prepd by treating cellulose with 83.4% H_2O_2 to form a gelatinous mass. This mixt is more powerful than TNT or Tetranitroaniline, but is insensitive to shock or friction and burns without detonation when dropped in a red hot crucible or ignited by flame. Its ignition temp is $194\text{-}208^\circ$. It cannot be stored for longer than 24-48 hours, as bubbles, resulting from decomposition of the H_2O_2 , are evolved and the mass hardens. Moreover its explosive power decreased after 48 hours of standing (Ref 1)

A Spanish patent claims an explosive compn prepd by mixing hexamethylenetetramine (See p H79 in this Vol) with Hydrogen Peroxide, and then adding HCl (Ref 9)

An explosive insensitive to mech and rifle bullet impact, but detonable by a blasting cap, is claimed in a US patent. It consists of Hydrogen Peroxide, water & glycerol (Ref 3)

Another patented high explosive composition contains powdered metal and Hydrogen Peroxide, eg 29.7% powd B & 70.3% H_2O_2 (Ref 19)

Hydrogen Peroxide in Propulsion. German use of high-concn Hydrogen Peroxide in propulsion, assisted take-off, torpedoes, special submarine turbines, etc during WWII is described in Ref 8

Use of high-concn Hydrogen Peroxide for rocket propulsion, details of its manufacture and safety are described by Cleaver (Ref 11)

A review of the fire and explosion hazards of flight vehicle fuels includes discussion of Hydrogen Peroxide. It gives vap press data (Ref 19)

Accdg to Ref 14a, Hydrogen Peroxide has been used as torpedo proplnt and rocket fuel oxidizer

Refs: 1) M.Bamberger & J.Nussbaum SS 22, 125 (1927) & CA 21, 4070 (1927) 2) W.L.Latimer & J.H.Hildebrand, "Reference Book of Inorganic Chemistry," Macmillan, NY(1941) 3) E.S. Shanley & H.O.Kauffmann, USP 2452074 (1948) & CA 43, 1190 (1949) 4) L.Médard MP 31, 273 (1949) & CA 46, 11687 (1952) 5) C.N.Satterfield et al, JACS 72, 4308 (1950) & CA 45, 2294 (1951); IEC 43, 2507 (1951) & CA 46, 1767 (1952) 6) F.Rossini et al, NBS Circular 500 (1952) 7) E.Haueseler, Explosivst 5/6 64 (1953) & CA 48 373 (1954) 8) H.Walther, Jet Prop 24,

166 (1954) & CA 48, 11061 (1954) 9) J.R. Mediavilla, SpanishP 203467 (1952) & CA 48, 14210 (1954) 10) C.N.Satterfield et al, IEC 47, 1040 (1955) & CA 49, 9927 (1955) 11) A.C.Cleaver, JBritInterplanetSoc 14, 159 (1955) & CA 49, 9929 (1955) 11a) PATR 2510 (1958), pp Ger 95-R & Ger 210-L (T-Stoff) 12) E.S. Shanley & J.R. Perrin, JetProp 28, 382 (1958) & CA 52, 21110 (1958) 13) C.N. Satterfield et al, JChemEngData 4, 131 (1959) & CA 54, 898 (1960) 14) J.S. Marshall, TransFaradSoc 55, 288 (1959) & CA 54, 1044 (1960) 14a) CondChemDict (1961), p 589-L 15) J.M. Monger, JChem-EngData 6, 23 (1961) & CA 56, 3713 (1962) 16) J.M.Kuchta et al, US Bur of Mines RI 5877 (1961) & CA 56 5010 (1962) 17) J.G.Williams "Hydrogen Peroxide in Organic Chemistry," Pamphlet, Electrochem Dept, Peroxygen Prod Div, EI Dupont de Numours (1962) 18) S.N.Foner & R.L.Mudson, JChem Phys 36, 2681 (1962) & CA 57, 15960 (1962) 19) R.W.VanDolah et al, US Bur of Mines Circ 8137 (1963) & CA 58, 7779 (1963) 20) S. Brunauer, USP 3111439 (1963) & CA 60, 2720 (1964) 21) J.M.Monger et al, JChemEngData 9 (11) 124 (1964) & CA 60, 7860 (1964) 22) A.F. Richter, Casopis Lekarů Ceskych (Czech) 104 (39) 1076 (1965) & CA 64, 4276 (1966) 23) Anon, USBur of Mines Info Circ 8387 (1968) & CA 69, 78878 (1968) 24) Sax (1968), p 824 25) CondChemDict (8th Edit, 1971) p 456

Hydrogen Peroxide (*Additional Information on German Manufacture and Uses During WWII*). Accdg to Dr Hans Walter, communicated during his work at Picatinny Arsenal, the name Wasserstoffperoxyd or Wasserstoffsperoxyx applies to any strength compd, while the name **T-Stoff** (T-stuff in Engl) is applied to 80–85% H_2O_2 and 20–15% H_2O . It was a clear viscous liquid fairly stable at ordinary temp and pressure when stored with a small amt of phosphoric acid, serving as a stabilizer. Such a mixt was known as **T-Stoff(S)** (Ref 4, p 8 & Ref 13, p Ger 210-R)

When H_2O_2 , contg ca 20% H_2O , was stabilized with oxyquinoline (400mg per liter), the mixt was known as **T-Stoff(SS)** (Ref 4, p 9 & Ref 13, pp Ger 210-R & 211-L)

However, even with the greatest care, it

was not possible to prevent on prolonged storage, a slow decompn into water and oxygen

For rapid estimation of its strength, either a hydrometer or titration with K or Na permanganate was used

Methods of manuf of H_2O_2 in Germany are described in Refs 2, 3, 5 & 6

One of the most interesting applications of T-Stoff was as a source of power turbines driving submarines as proposed by Dr Helmuth Walter (See *U-Boot, Walter* in Ref 13, p Ger 211-R). Seven of such submarines (300 to 500 tons each) were accepted by the German Navy up to the end of WWII

Besides submarine, the following applications of T-Stoff are listed in Ref 13, p Ger 210

- a) A 500kg ATO (Assisted Take-Off) T-Stoff monofuel unit
- b) A 300-kg thrust, rocket propulsion unit for guided missiles
- c) A bipropellant 1000 to 1500-kg ATO
- d) A catapult with T-Stoff propulsion unit (decompn only) for launching V-1, 2 which is described in Ref 13, p Ger 213-L
- e) Controllable propulsion of a 750-kg thrust unit for Messerschmitt 263
- f) Rocket training airplane and a controllable power plant giving to 2000 kg thrust for the Messerschmitt 263B

Accdg to Ref 4, p 8, T-Stoff was used as an oxygen carrier in some guided missile proplnts, such as in *Hecht* (Pike), listed in Ref 13, p Ger 132-L as Pike Missile and described in Ref 11, pp 116–17. In order to accomplish this, T-Stoff was mixed with *Z-Stoff* which was an aq soln of K or Na permanganate, described in Ref 13, p Ger 264-R. This mixt produces superheated steam, attaining temp of 180° . This steam was also suitable for driving rockets and ATO, but was not suitable for driving turbines, because it contd small particles of MnO_2 which might foul the blades of turbine. However, the superheated steam formed as result of mixing T-Stoff with MP-14 catalyst, described in Ref 13, p Ger 114-L can be used for driving steam turbines

When T-Stoff was mixed with *B-Stoff* (Hydrazine Hydrate), in the presence of K cuprocyanide, the resulting liquid spontaneously ignited

Accdg to Ref 4, p 8, T-Stoff was also known

as **Ingolin**. Accdg to Ref 7, p 23, the code name **T-Stoff** was used only for 82% H_2O_2 , while the code names **Aurol**, **Nauralin** and **Subsidol** were used for any 80 to 86% Hydrogen Peroxides

Refs: 1) Dr Nitschmann, "Physical and Chemical Investigations of T-Stoff Solutions", IGFarbenind Rept **597**, Oppau, Germany (1944) 2) B.E.A. Vigers et al, "Hydrogen Peroxide Production by Electrolysis of 35% Per Cent Solutions", BIOS FinalRept **683** (1945) 3) V.W. Slater et al, "The Anthraquinone Autoxidation Process for the Production of Hydrogen Peroxide", CIOS Rept **31-15** (1945) 4) R.C. Stiff, CIOS Rept **30-115** (1945), pp 8-9 & 12-13 5) J. McAulay, "Hydrogen Peroxide Manufactured by All-Liquid Process from Ammonium Persulfate", CIOS Rept **33-43** (1945) 6) J. McAulay, "Direct Synthesis of Hydrogen Peroxide by Electric Discharge", CIOS Rept **33-44** (1945) 7) H.A. Curtis, CIOS Rept **28-62** (1946) 8) Logan McKee, MechEngrg **68**, 1045-48 (1946) (Hydrogen Peroxide for propulsive power; production and use by the Germans during WWII) 9) E.S. Shanley & F.P. Greenspan, IEC **39**, 1536-43 (1947) (Props of highly concd Hydrogen Peroxide) 10) R. Simard, The Engineering Journal of Canada **31**, 219-25 (1948) 11) F. Ross, Jr, "Guided Missiles", Lothrop, NY (1951), 45-6 11a) K.W. Gatland, "Development of the Guided Missiles", Iliffe, London (1952), 116-17 (Pike or Hecht Missile developed in 1941 by the Rheinmetall Borsig AG) 12) Hans Walter, JetPropulsion **24**, 166-71 (1954) (Experience with the application of Hydrogen Peroxide for production of power) 13) B.T. Fedoroff et al, PATR **2510** (1958), p Ger 95 (Hydrogen Peroxide) & Ger 210 (T-Stoff). Other pages are indicated in the text

Hydrogen Selenide, H_2Se , mw 80.98; colorless gas, fr p -64° , bp -41.4° , d 3.614g/liter (gas), 2.12 at -42° (liq); vap press 10 atm at 23.4° ; can be formed in small amts on heating Se in hydrogen & by action of nascent H on selenious acid. Pure H_2Se is obt'd by action of water on Al selenide (Refs 1 & 2)

The compd is highly toxic by inhalation, strongly irritating to the skin, and causes damage to the lungs & liver. It reacts violently with

oxidizing materials and forms expl mixts with air (Refs 1, 3 & 4)

Refs: 1) Gmelin Syst No 10 (1949), p 2 2) Partington (1950), 498-99 3) Sax (1968), 825-R 4) CondChemDict (1971), 456-L

Hydrogen Sulfide. H_2S , mw 34.08, colorless gas, mp -83.8° , bp -60.2° , auto ign temp $500^\circ F$, d 1.54g/l at 0° . It is highly toxic by inhalation and is a strong irritant to eyes and mucous membranes. It is highly flammable and has wide explosive limits in air: lower limit 4.3 vol%; upper limit 46 vol%

Ref: CondChemDict (1971), p 456

Hydrogen Telluride. H_2Te , mw 129.63, colorless gas or yellow needles, mp -49.0° , bp -2° , d 5.81g/l. It is highly toxic and is an irritant but it does not present the fire & explosion hazard of H_2S or H_2Se

Ref: CondChemDict (1971), p 456

Hydrogen Tetraoxide. H_2O_4 , mw 66.02. This substance exists only at low temps and is probably H_2O_4 rather than H_2O_3 (Ref 3). It is probably non-planar with a $\Delta H_f^\circ = -27.9$ kcal/mole (Ref 1). It has been prep'd by reacting $H+O_3$ or $H+O$ and its reactions with NH_3 , Cl & C_2H_4 have been examined (Ref 2). A review of the general subject of higher peroxides, including H_2O_4 is given in Ref 3

Refs: 1) D.A.Csjeska et al, JPhysChem **68**, 3878 (1964) & CA **62**, 5947 (1965) 2) D.A.Csjeska, US Govt Res Develop Rept **40** (7), 53 (1965) **AD617964** & CA **64**, 267 (1966) 3) L.I. Nekrasov et al, ZhFizKhim **45** (4) 1017 (1971) & CA **75**, 29790 (1971)

Hydrolysis. The chemical reaction of a substance with water to form one or more new substances. Examples of hydrolysis are: the catalytic conversion of starch into glucose; the catalytic or enzymatic conversion of sucrose into glucose and fructose; the conversion of natural fats into fatty acids and glycerin

In general hydrolysis is a reaction of the type: $AB+H_2O = AOH+HB$, which in its ionic form: $H_2O = H^++OH^-$ is the reverse of neutralization. As examples:

In inorganic chemistry:

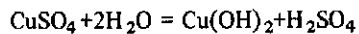

In organic chemistry:

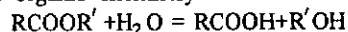

In biochemistry (by enzymes):

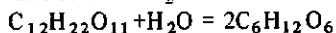
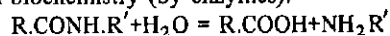

Refs: 1) Hackh's Dict (1944), 423-R

2) Groggins (1952), 651-70

Hydrolysis of Plasticizers for NC by Water at 22° and 60°C. Following tests were conducted in 1945 at Picatinny Arsenal by P. F. Macy and A. A. Saffitz:

a) Place a sample of about 5g of material to test in a small flask contg 12.5 ml of CO₂-free neutral distilled water. Stopper and shake for 10 days at 22° in a rotary, end over end, shaker apparatus placed in a constant temperature room

b) Determine the acid liberated during the exposure period by titrating the sample water mixture with either N/10, or N/50 sodium hydroxide solutions in presence of phenolphthalein indicator. Titrations should be conducted separately on the oil and water layers of the mixture. If the organic acid liberated during the hydrolysis is more soluble in the oil layer than in the water layer, 5ml of cp acetone should be added to the oil to reduce possible errors arising due to low solubility of the standard alkali in the oil. Blank determination shall be made in all cases with water and acetone, and the necessary corrections applied

c) Express the acidity as grams of acid produced (mineral acid in case of ester nitrates, and organic acid in case of phthalates, acetates, lactate-nitrates, acetate nitrates) per 100g of starting material at the specified temperature for the entire test period

d) Hydrolysis at 60° ± 1°C was conducted by shaking for 5 days in a rocker device contained in Cenco Electric Oven, Model No 95, 105A

Following are some results:

Table
Hydrolysis of Plasticizers for NC

Substance	Hydrolysis; % acidity	
	At 22°	At 60°
Butanediol-1,3-dinitrate (BDN-1,3)	—	1.1
Butanediol-1,4-dinitrate (BDN-1,4)	—	1.7
Diacetin mononitrate (DAM)	—	28.5
Dibutylphthalate (DBP)	0.002	0.011
Diethyleneglycoldinitrate (DEGDN)	0.003	0.003
Dinitroethylbenzene (DNEB)	0.007	0.028
Dipropyleneglycol-dinitrate (DPGDN)	—	0.123
Dimethylmethylol-nitromethenemononitrate	—	0.185
Ethyltrimethylol-methanetrinitrate (EMMET)	0.003	0.002
Glycerol mono-lactatetrinitrate (GLTN)	0.021	0.014
Glycolmonoethylether-mononitrate (GEEN)	—	0.637
Glycolmonomethylether-mononitrate (GMEN)	—	0.181
Metroil trinitrate (MTN)	0.018	0.115
Monoacetinedinitrate (MAD)	—	21.3
Nitroglycerin (NG)	<0.002	0.005
Triethyleneglycol-dinitrate (TEGDN)	0.032	0.003
Trinitrophenyl-ethanolnitrate (TNPEN)	<0.001	0.01

Ref: P.F. Macy & A.A. Saffitz, PATR's 1616 (1946); 1638 (1947)

Hydrolysis Test for Nitrocelluloses. The following hydrolysis test was developed and is used at Picatinny Arsenal

a) Weigh accurately a 5g sample of dry NC, place in a tared 250ml Pyrex flask provided with a ground connection to fit a Pyrex condenser

b) Add 100ml of distilled neutral (conductivity) water and boil the water under reflux condenser during 240 hours

c) Cool the flask and filter off the water into a 500ml volumetric flask. Rinse the NC with several portions of conductivity water, using sufficient amount to fill the flask to 500ml mark

d) Stopper the flask, shake and take an aliquot. Determine its pH, using a standard procedure

e) Take another aliquot and titrate it with a standard NaOH soln in presence of methyl red indicator

Note: In one of the tests conducted at Pic. Arsenal the Pyro (N=12.6%N) gave 1.22%, calcd as HNO_3 and Guncotton (N=13.45%) gave 1.03%

Refs: 1) D.D. Sager, *PATR* **174** (1932)

2) W.R. Tomlinson & O.E. Sheffield, *AMCP* **706-177** (Jan 1971), p 9

Hydrolytic Reaction. Pertaining to *Hydrolysis*. Comp with *Hydroxylation*
Ref: Hackh's Dict (1944), 423-R

Hydrometer. A device for measuring specific gravity of liquids. Its description with Fig is given in Vol 3 of Encycl, p D67, under DENSITY AND SPECIFIC GRAVITY

Hydronitric Acid. Same as Hydrazoic Acid or Azoimide. See in Vol 1, p A537-R

Hydronitrides. Same as Azides

HYDRONITROGENS. Compounds containing only hydrogens and nitrogens. Some thirteen different hydronitrogens are known, mostly not in the free state, but as derivatives. There are saturated and unsaturated derivatives

Saturated Hydronitrogens (Type formula N_nH_{n+2}). **Ammonia** NH_3 ; **Hydrazine** (diamide) $\text{H}_2\text{N.NH}_2$; **Triazane** (prozane) $\text{H}_2\text{N.NH.NH}_2$; **Tetrazane** (buzane, hydrotetrazane) $\text{H}_2\text{N.NH.NH.NH}_2$. Ammonia and Hydrazine are known in the free state; the Triazanes are rather poorly defined as a class, whereas Tetrazanes exhibit a tendency towards instability by undergoing dissociation in solution to yield hydrazyl radicals

Unsaturated Hydronitrogens (Type formula N_nH_n). **Diamide** HN:NH ; **Triazene** (diazoamine)

HN:N.NH_2 ; **Tetrazene** (tetrazone, or 2-tetrazene) $\text{H}_2\text{N.N:N.NH}_2$; **Isotetrazene** (1-tetrazene, diazohydrazene, buzylene) HN:N.NH.NH_2 ; **Ammonium Azide**, $\text{NH}_4\text{.N}_3$; **Hydrazine Azide**, $\text{N}_2\text{H}_5\text{.N}_3$

Type formula N_nH_{n-2}

Hydrogen Azide (hydrazoic acid, azoimide, hydronitric acid, triazoic acid) HN:N:N ; **Diimino-Hydrazine** HN:N.NH.N:NH ; **Bisdiazoamine** HN:N.NH.N:NH ; **Hexazodiazene** HN:N.NH.NH.N:NH ; **Heptazodiazene** $\text{H}_2\text{N.N:N.NH.N:N.NH}_2$

Type formula N_nH_{n-4}

Octazotriene (octazone) $\text{HN:N.NH.N:N.NH.N:NH}$

Many of the derivatives of the above compounds are explosive and they are described separately under corresponding names. Some of the compounds included in these tables (as for instance ammonium azide and hydrazine azide), do not possess the structural formula of real hydronitrogens but they are included for the sake of comparison, because their empirical formulas correspond to the type N_nH_{n-2}
Refs: 1) L.F. Audrieth & B.A. Ogg, "The Chemistry of Hydrazine", J. Wiley, NY (1951), p 3-6 2) C.C. Clark, "Hydrazine", Mathieson Chem Corp, Baltimore, Md (1953)

Hydronitrous Acid or Nitroxyl Acid, HNO , mw 48.02. The hypothetical acid from which *nitroxyls* are derived. The nitroxyl radical is $-\text{NO}_2$, when attached to a strongly electro-negative group such as F or Cl or to metal forming compds such as NO_2F , NO_2Cl or $\text{Cu}_2(\text{NO}_2)$

Ref: Hackh's Dict (1944), 424-R & 580-R

Hydronium Ion. The solvated hydrogen ion, $\text{H}^+(\text{H}_2\text{O})$ or H_3O^+ , which is considered to be present in all acids:

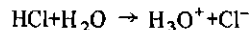

Hydroperoxides, Organic. Are monosubstituted derivatives of hydrogen peroxide ROOH , where R is alkyl or aralkyl radical. They generally may be prep'd by the following methods: a) alkylation of H_2O_2 with alkyl halides, sulfates, or alcohols in the presence of strong acids; b) controlled oxidation of the hydrocarbon RH with O_2 ; c) addition of O_2 to Grignard reagents. A brief discussion of prep'n and properties of hydroperoxides (including explosive: methyl-, ethyl-, isopropyl-, t-butyl-, tetralin-, decalin-, and phenylhydrazone- hydroperoxides) is given in Ref 2

A table of the explosive nature of peroxides, taken from Ref 3, is given below:

EXPLOSIVE NATURE OF PEROXIDES

Peroxide	Remarks Concerning Explosiveness	Ref
ALKYL HYDROPEROXIDES		
Methyl Hydroperoxide	Explodes violently; sensitive to jarring especially at warm temps; greatest caution in making. Ba salt in dry state extremely explosive	A. Rieche & F. Hitz, Ber 62 , 2458 (1929)
Ethyl Hydroperoxide	Explodes on superheating quite violently, Ba salt, heat and percussion sensitive	A. Baeyer & V. Villiger, Ber 34 , 738 (1901)
Isopropyl Hydroperoxide	Explodes just above bp	S. Medvedev & E.N. Alexejeva, Ber 65 , 133 (1932)
<i>t</i> -Butyl Hydroperoxide	By distn under normal pressures explosions can result; otherwise relatively harmless	N.A. Milas & D. Surgener, JACS 68 , 205 (1946)
Tetralin Hydroperoxide	Detonated by superheating	H. Hock & W. Susemichl, Ber 66 , 22 (1944)
Decalin Hydroperoxide	Very stable; can be sublimed in small quantities at atm pressure	R. Criegee, Ber 77 , 22 (1944)
Triphenylmethyl Hydroperoxide	Not explosive	H. Wieland & J. Maier, Ber 64 , 1205 (1931)
Phenylhydrazone Hydroperoxide	Detonates in dry state after a short time with no evident cause	W. Busch & W. Dietz, Ber 47 , 3277 (1914)
DIALKYL PEROXIDES		
Dimethyl Peroxide	Extremely explosive on heating and jarring; vapors also sensitive to shock	A. Rieche & W. Brumshagen, Ber 61 , 951 (1928)
Methylethyl Peroxide	Liquid and vapor forms shock-sensitive; explodes violently on superheating	A. Rieche, Ber 62 , 218 (1929)
DIACYL PEROXIDES		
Diacetyl Peroxide	Highly explosive; to be handled only with extraordinary caution	L.P. Kuhn, C&EN 26 , 3197 (1948)
Dicapronyl Peroxide	Detonates at 85°C	F. Fichter & R. Zumbrunn, HelvChimActa 10 , 869 (1927)
Bis-hexahydrobenzoyl Peroxide	Large quantities can explode without apparent reason	F. Fichter & W. Siegrist, HelvChimActa 15 , 1304 (1932)
Difuroyl Peroxide	Explodes violently by rubbing and heating	N.A. Miles & A. McAlevy, JACS 56 , 1219 (1934)
Dibenzoyl Peroxide	Exploded by heat; carry out recrystns of large quantities without heating	K. Nozaki & P.D. Bartlett, JACS 68 , 1686 (1946)
1-Naphthoyl Peroxide	Explodes by rubbing	S. Mededeco & O. Bloch, ChemZbl 1935 I, 2670

EXPLOSIVE NATURE OF PEROXIDES (Cont'n)

Peroxide	Remarks Concerning Explosiveness	Ref
PEROXY DERIVATIVES OF ALDEHYDES AND KETONES		
Hydroxymethyl Hydroperoxide	Explodes on heating; not sensitive to friction; higher homologs not explosive	A. Rieche & R. Meister, Ber 68 , 1465 (1935) A. Rieche, Ber 64 , 2328 (1931)
Hydroxymethyl Methyl Peroxide	Violently explosive, on heating becomes percussion-sensitive	A. Rieche & F. Hitz, Ber 62 , 2458 (1929)
1-Hydroxyethyl Ethyl Peroxide	Detonates on heating	A. Rieche, Ber 63 , 2642 (1930)
Bishydroxymethyl Peroxide	Highly explosive; strongly friction-sensitive	H. Wieland & H. Sutter, Ber 63 , 66 (1930)
Bis(1-hydroxycyclohexyl) Peroxide	Harmless by itself; but explodes on attempted vacuum distn	M. Stoll & W. Scherrer, HelvChimActa 13 , 142 (1930)
Bishydroperoxydicyclohexyl Peroxide	Detonates very actively in a flame	R. Criegee, W. Schnorrenberg & J. Becke, Ann 565 , 7 (1949)
1-Hydroperoxy-1-acetoxycyclodecan-6-one	Detonates on removal from a freezing mixture	R. Criegee & G. Wenner, Ann 564 , 9 (1949)
Dimeric Ethylidene Peroxide	Explodes with extreme violence just by touching; <i>greatest caution!</i>	A. Rieche & R. Meister, Ber 72 , 1933 (1939)
Polymeric Ethylidene Peroxide (Ether Peroxide)	Extremely explosive, even below 100°C	Eg, A. Rieche & R. Meister, AngewChem 49 , 101 (1936)
Trimeric Propylidene Peroxide	Extremely explosive; very friction-sensitive	A. Rieche & R. Meister, Ber 72 , 1938 (1939)
Dimeric Acetone Peroxide	Explodes violently by percussion and rubbing	A. Baeyer & V. Villiger, Ber 32 , 3632 (1899)
Trimeric Acetone Peroxide	Very explosive; can penetrate a plate of iron when heated on it	A. Baeyer & V. Villiger, Ber 32 , 3632 (1899)

Properties of hydroxalkyl hydroperoxides and hydroxyalkyl peroxides are shown in the following table (from Ref 3):

PEROXY DERIVATIVES OF ALDEHYDES AND KETONES

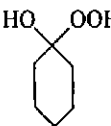
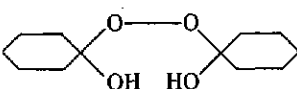
A. 1-Hydroxyalkyl Hydroperoxides				
Name	Formula	n_D^{20}	mp, C	bp, C/mm Hg
Hydroxymethyl Hydroperoxide	HOCH OOH	1.4205 (16)	—	—
1-Hydroxyethyl Hydroperoxide	CH ₃ CH(OH)OOH	1.4250 (24)	—	—
1-Hydroxyheptyl Hydroperoxide	C ₆ H ₁₃ CH(OH)OOH	—	40	—
1-Hydroxydodecyl Hydroperoxide	C ₁₁ H ₂₃ CH(OH)OOH	—	65 to 67	—
1-Hydroxycyclohexyl Hydroperoxide		—	76 to 78	—
B. Bis(1-hydroxyalkyl) Peroxides				
Bishydroxymethyl Peroxide	CH(OH)OOCH(OH)	—	62 to 64	—
Bis(1-hydroxyethyl) Peroxide	CH ₃ CH(OH)OOCH(OH)CH ₃	1.4265 (16)	—	—
Bis(α-hydroxybenzyl) Peroxide	C ₆ H ₅ CH(OH)OOCH(OH)C ₆ H ₅	—	—	—
Bis(α-hydroxy-β,β-trichloroethyl) Peroxide	CCl ₂ CH(OH)OOCH(OH)CCl ₂	—	122	—
Bis(1-hydroxycyclohexyl) Peroxide		—	68 to 70	—

The reduction of hydroperoxides with LiAlH₄ yields the corresponding alcohols probably via an LiAl(OR)₄ intermediate. However this reaction with Bz₂O₂ resulted in an explosion (Ref 1)

Cumene hydroperoxide (91-95% pure) will not detonate even when strongly boosted. However, it is easily ignitable & can burn with sufficient violence to rupture steel distillation equipment (Ref 4)

Refs: 1) D.A. Sutton, Chem & Indust (1951), 272 & CA 45, 8885 (1951) 2) R. Criegee, "Herstellung und Umwandlung von Peroxyden" in Houben-Weyl, Methoden der organischen Chemie, 4th edit, Stuttgart, Vol VIII, 6 (1952)

3) Tobolsky & Mesrobian (1954), 2-17, 158 & 177 4) A. LeRoux, MP 39, 49 (1955) & CA 51, 718 (1956)

Hydroquinone and Derivatives.

Hydroquinone, Hydroquinol, 1,4-Benzenediol or p-Dihydroxybenzene (Hydrochinon in Ger). See 1,4-Dihydroxybenzene in Vol 5 of Encycl, p D1270-R

Hydrous. A compd contg water, as opposed to *anhydrous*. In case of salts it is water of crystallization

Ref: Hackh's Dict (1944), 425-R; (1969), 335-L

Azidohydroquinone, $N_3 \cdot C_6H_3(OH)_2$; mw 151.12, N 27.81%, OB to CO_2 -132.3; leaflets, mp-explodes violently on heating; sol in alc or eth, insol in petr eth. It can be prepd from quinone and an excess of hydrazoic acid in benz

Refs: 1) Beil 6, (419) 2) E. Oliveri-Mandalà & E. Calderaro, Gazz 45 I, 312 (1915); 45 II, 120 (1915) & CA 10, 596-7 & 1514-5 (1916)

Diazidodinitro hydroquinone, $(OH)_2C_6H_2(N_3)_2(NO_2)_2$ (probably), mw 284.15, N 39.41%, OB-11.2, fine yellow needles (from mixed acid) It is claimed that the K salt is prepd by reacting nitroaminoresorcinol with conc mixed acid containing an excess of K-nitrate

The 3,5-dihydroxyquinonediazide (sic) is claimed to be prepd similarly from the mono or diaminophloroglucinols. These compds are claimed to be unstable in detonators in conjunction with PETN or other HE as the base charge

Ref: E. von Herz, BritPat 207563 (1922) & CA 18, 1574 (1924)

Nitrohydroquinone, $OH \cdot C_6H_3(NO_2)OH$, mw 155.11, N 9.03%, red rhombohedral grains or pyramids (from w) mp 133-134°, sl sol in w; v sol in alc & eth. Prepd from o-nitrophenol & aq NaOH + ammonium persulphate and then dil sulfuric acid (Ref 1); by nitrating monobenzenesulfonate (Ref 4)

The effect of pH on the uv spectrum of nitrohydroquinone has been studied (Ref 2), also its dissociation constants, redox potentials & dipole moments (Ref 5), as well as its electronic spectra (Ref 6). Its thin layer chromatographic props were also investigated (Ref 3)

Refs: 1) Beil 6, 856 (418) & [848] 2) H. Staude & M. Tempel, Z Electrochem 61, 181 (1957) & CA 52, 2533 (1958) 3) D. B. Parihar et al, JChromatog 24 (1) 230 (1966) & CA 66, 8141 (1967) 4) E.M. Kampouris, JChemSoc (1967) 1235 & CA 67, 63964 (1967) 5) J. Sunkel & H. Staude, BerBunsengesPhysChem 72 (4) 567 (1968) & CA 69, 86177 (1968) 6) Ibid 73 (2) 203 (1969) & CA 70, 91936 (1969)

2-6 Dinitrohydroquinone, $(OH)_2C_6H_2(NO_2)_2$, mw 200.11, N 14.00%, golden platelets (from w) mp 135-136° (some color change), sol hot water, alc, eth. Prepd by nitrating hydroquinone-diacetate (Ref 1); nitration of monobenzene-sulfonate (Ref 2). Its Ba salt, $BaC_6H_2N_2O_6 \cdot 3H_2O$, dk-blue crystals, when anhyd is very expl (Ref 1a) *Refs:* 1) Beil 6, 858, (418), [850] & [4444] 2) E.M. Kampouris, JChemSoc (1967), 1235 & CA 67, 63964 (1967)

Trinitrohydroquinonedithylether,

$(O_2N)_3C_6H(OC_2H_5)_2$; mw 301.21, N 13.95%; yellow needles that turn yellow-orange on exposure to light, mp 130°, insol in w, somewhat sol in alc, eth or benz. Prepd by nitrating hydroquinone-dithylether with mixed acid

Refs: 1) Beil 6, 859 2) Nietzki, Ann 215, 153 (1882)

Hydrosilicofluoric Acid. See Fluorosilicic Acid in Vol 6 of Encycl, p F141-R

Hydrosol. A colloidal suspension in water (Ref 1). Also Brand name of L.B. Holliday & Co, Ltd, Huddersfield, England for a proprietary product of the hydrosulfite class for wool bleaching (Ref 2)

Refs: 1) Hackh's Dict (1944), p 425-R 2) CondChemDict (1961), p 591-L; (1971), p 457-R

Hydrostatic Fuze. See Vol 4, p D881-R

Hydrostatics. The science of physics which deals with liquids in equilibrium (Comp with Hydrodynamics)

Refs: 1) Hackh's Dict (1944), 425-L; (1969), 335-L

Hydrox. Is a blasting device for underground mining primarily used in coal mines. Like *Cardox* (see Vol 2, p C67-R) it employs a gas generating chemical reaction to rupture a disk in a heavy-walled steel tube with the resulting flow of high pressure gas then doing mechanical work on the surroundings. The usual gas producing system is (Ref 1):

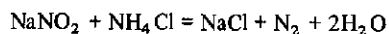

This reaction is self-sustaining (once started) but

does not generate flames. Usually the rupture disk is selected to break at about 10 tons per sq inch (Ref 1)

A simple calcn shows that for this reaction the heat of explosion is 52.4 kcal/mole or 428 kcal/kg; the explosion temp (the temp that can be reached by explosion within a closed vessel) is about 1430°, and the vol of the gas evolved at normal temp & pressure is 540l/kg. The ignition temps of mixts of various NaNO₂/NH₄Cl ratios, r, was found to be the lowest for r=1:2. The mixts, when stored over CaCl₂, undergo spontaneous explosion after 30-50 days, but stabilizers such as 2% of: MgO, CaO, CaC₂, BaCl₂, MgCO₃, Na₂CO₃ were effective in preventing explosions for more than a year. The max pressure developed by the explosion was 790 kg/sq cm at a loading dens of 0.3; 1200 kg/sq cm at a loading dens of 0.4; and 1700 kg/sq cm at a loading dens of 0.5 (Ref 2)

Other reactions have been patented for use in Hydrox. Some additional ingredients claimed in these patents are AN, NH₄HCO₃, chromates and dichromates. These compositions and the use of Hydrox are discussed in detail in Refs 3 & 4

Refs: 1) J. Taylor, *Ind Chemist* **24**, 289 (1948) & *CA* **42**, 6116 (1948) 2) S. Yamamoto et al *JIndExplosSoc*, Japan **15**, 77 (1954) & *CA* **49**, 11281 (1955) 3) J. Taylor & P. F. Gay "British Coal Mining Explosives" pp 127-133, Geo. Newnes, London (1958) & *CA* **53**, 719 (1958) 4) R. McAdam & R. Westwater "Mining Explosives" pp 90-91, Oliver & Boyd, Edinburgh (1958) & *CA* **53**, 9673 (1958)

Hydrox Fuel Cell. See under Fuel Cells in Vol 6 of Encycl, p F210-R

Ref: *CondChemDict* (1961), 517-L (Fuel Cells); (1971), 403-R

Hydroxides. The generic name for compounds of the type M_a(OH)_b where M is a metal and a & b are integers. Most hydroxides are insol or sparingly sol in water but are sol in aq acid with the formation of salts. Most hydroxides have been used in neutralizing nitrated explosives made by mixed acid or nitric acid nitration although bicarbonates are more commonly employed. The more common hydroxides are listed below:

Aluminum hydroxide. Al(OH)₃, mw 77.99, white cryst powder, d 2.42, insol in w, sol in acids & NaOH. Derived from bauxite

Ref: *CondChemDict* (1971), p 33

Ammonium Hydroxide or Ammonia, Aqueous. See under AMMONIA in Vol 1 of Encycl, pp A296 to A305 and in *CondChemDict* (1971), p 52-R

Barium Hydroxide. Exists as *Anhydrous*, Ba(OH)₂, available commercially; *Monohydrate*, Ba(OH)₂.H₂O, wh powd, highly toxic, has many industrial uses; *Pentahydrate*, Ba(OH)₂.5H₂O, translucent free-flowing wh flakes, d 65lbs/cu ft, highly toxic; and *Octahydrate*, wh crystals, mp 78°, loses w of crystallization at 408°, d 2.18 g/cc; sol in water, alc & eth, highly toxic; prepd by dissolving Ba oxide in w with subsequent crystallization and by other methods, used in org prepn, Ba salts & in analytical chem
Refs: 1) *CondChemDict* (1971), p 92-R to 93-L 2) US Spec MIL-B-36212 (May 1964) (Ba Hydroxide, Lime, USP, Granular)

Calcium hydroxide. Ca(OH)₂, mw 74.10, rhombic colorless crystals, mp (loses water at) 580°, d 2.343, v sl sol in w, insol in alc, sol in acids; absorbs carbon dioxide from air. Prepd by action of water on CaO

Refs: 1) *CondChemDict* (1971), p 156
2) Spec for Tech grade: O-C-110A (March 1962)

Lithium Hydroxide. LiOH, mw 23.95, white powder, mp 450°, d 1.43; sol in water & acids, sl sol in alc. Prepd by action of water on Li₂O

Refs: 1) *CondChemDict* (1971), p 524
2) Spec MIL-L-20213D (July 1964)

Magnesium Hydroxide. Mg(OH)₂, mw 58.34, colorless trigonal crystals, loses w at 380°, d 2.38, sl sol in hot water, sol in alc, sol in acids & in solns of ammonium salts. Obtainable from sea water by precipitation with CaO

Ref: *CondChemDict* (1971), p 535

Potassium Hydroxide. KOH; mw 56.11, white, rhombic, deliquescent crystals; mp 360°, bp 1320°, d 2.044; sol in w, alc or acids; insol in eth. Prepd by electrolysis of concd KCl solns

Refs: 1) *CondChemDict* (1971), p 722
2) US Spec for KOH Soln: MIL-P-11751B (Dec 1958) 3) US Spec for Tech KOH: D-P-566 (Nov 1960)

Sodium Hydroxide. NaOH; mw 40.01; white deliquescent crystals, mp 318°, bp 1390°, d 2.13; sol in w, alc, glycerin & acids; insol in eth or acetone. Prepd by electrolysis of NaCl solns

Refs: 1) CondChemDict (1971), p 802
2) US Spec for Tech NaOH O-S-598A, IntAmed (1) (July 1968)

Hydroxy (Hydroxyl). A prefix indicating the presence of the monovalent OH group in an org compd analogous to acids of the lactic series. It is preferable to *oxy-* used by the Germans
Ref: Hackh's Dict (1944), 425-R; (1969), 335-R

Hydroxyacetanilide and Derivatives

Hydroxyacetanilide. Same as Acetamidophenol, Vol 1, p A20-R

2-Hydroxy-3,4,6-trinitroacetanilide. See 3,5,6-Trinitro-2-acetamidophenol in Vol 1, p A21-R

Hydroxyacetazide. See Glycolic Acid Azide, or Glycolyl Azide in Vol 6, p G115-R

Hydroxyacetophenone and Derivatives

Hydroxyacetophenone. $\text{OHC}_6\text{H}_4\text{COCH}_3$, mw 136.14. Three isomers are known: *ortho* - greenish-yel oil, fr p 4-6°, bp 213° at 717mm, sp gr 1.1307 at 21°, refr ind 1.5580 at 20°; sl sol in w; sol in alc & eth (Refs 1, 4 & 5); *meta* - crystals, mp 95-6°, bp 296° at 756mm; sol in alc & eth and hot w (Ref 2); *para* - crystals, mp 109°, bp 147-48° at 3mm, sl sol in w, sol in alc & eth (Ref 3)

Refs: 1) Beil 8, 85, (534) & [81] 2) Beil 8, 86, (535) & [84] 3) Beil 8, 87, (536) & [84] 4) CondChemDict (1961), 592-L 5) Ibdid (1971), p 457-R (ortho)

Hydroxyacetophenone Azide (called Azido-4-oxy-acetophenone in Ger) $\text{HOC}_6\text{H}_4\text{COCH}_2\text{N}_3$, mw 177.16, N 23.72%; yel leaflets (from w) mp 136°, sol in the usual solvents except benzene; decomposes in boiling w Prepd by heating 4-hydroxy-chloroacetophenone with Na Azide in alc. No explosive props are mentioned
Ref: Beil 8 [87]

Hydroxy-trinitro-acetophenone (called Trinitro-4-oxy-acetophenon in Ger), $\text{HOC}_6\text{H}(\text{NO}_2)_3\text{COCH}_3$; mw 271.14, N 15.50%, crystals; sl sol in hot w.

Prepd by heating 4-hydroxyacetophenone with 1.3 g/cc nitric acid. No explosive props mentioned

Refs: 1) Beil 8, 89 2) Nencki & Stoeber, Ber 30, 1770 (1897)

Hydroxyalkyl Alkylene Dinitramines and Their Nitrate Esters.

Nitrate esters such as *N,N'*-bis-(2-nitroxyethyl) ethylenedinitramine. $\text{O}_2\text{NO}-\text{C}_2\text{H}_4-\text{N}(\text{NO}_2)-\text{C}_2\text{H}_4-\text{N}(\text{NO}_2)-\text{C}_2\text{H}_4-\text{ONO}_2$ (qv) were proposed as non-volatile plasticizers for NC in prepn of propellants. The method of prepn consists of the hydroxyalkylation of a nitramine (such as ethylenedinitramine) by means of an alkylene oxide (such as ethylene oxide), followed by nitration:

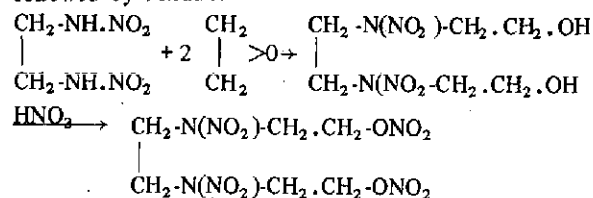

N,N'-bis(2-hydroxyethyl) ethylenedinitramine

Ref: J. R. Johnson et al, USP 2683165 (1954) & CA 49, 7590 (1955)

Hydroxyaminoanthraquinones and Derivatives.

See Aminohydroxyanthraquinone and Derivatives in Vol 1 of Encycl, p A217-L. Its **Tetranitro-derivative** (*Aminochrysammic Acid*), described on p A217-L, forms expl salts of *Ammonium*, *Barium* and *Potassium*

Hydroxyaminobenzene. See Aminophenol in Vol , pp A241-L to A244-R. Its expl derivs:

1-Hydroxy-2-amino-4,6-dinitrobenzene or **Picramic Acid** and **1-Hydroxy-4-amino-2,6-dinitrobenzene** or **Isopicramic Acid** are on pp A241-R & A243-R

Hydroxyaminobenzoic Acid. See Aminosalicilic Acid in Vol 1, p A257

1-Hydroxy-6-aminobenzotriazole or **6-Aminobenzotriazole** (called oxy-6-amino-benzotriazol in Ger)

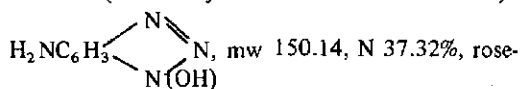

colored powder, mp 220° (with carbonization), puffs off at 235-36° without melting; sol in hot water & hot alc, insol in eth or ligroin. Prepd by treating 1-hydroxy-6-nitro-benzotriazole with Sn & concd HCl

Refs: 1) Beil **26**, 326 2) T. Curtius & (?) Mayer, JPraktChem [2] **76**, 395 (1907)

Hydroxyaminobutane. See Aminobutanol in Vol 1, p A192-R

Hydroxy and Amino Compounds, Explosives from. A number of commercially available amino alcohols have been condensed with 2,4-dichlorobenzene to give products which, when nitrated, are explosive. Products from the nitration of several glycerol derivs, guanidine derivs & phenylbenzotriazole derivs were also studied. Prepn of the following compds & their props are reported:

Trinitrophenylnitroguanidine
N-(β-Hydroxyethyl)-N'-nitroguanidine Nitrate
Tris-Hydroxymethylmethylguanidine
N,N'-Dinitropiperazine
Tetryl

Of other expls produced, Heptryl, Ditetryl & Trinitrophenylisobutylolnitramine Nitrate appeared especially worthy of further study
Ref: R. C. Elderfield et al, "Explosives from Hydroxy and Amino Compounds," OSRD Repts **158** (1941) & **907** (1942)

Hydroxyaminomethylbenzene or **Hydroxyaminotoluene.** See Aminocresol in Vol 1, p A193-R

Hydroxyaminomethylpropane. See Aminomethylpropanol in Vol 1, p A233-L

Hydroxyaminopropane. See Aminopropanol, Vol 1, p A253-L & R

Hydroxy- and Amino-methylnitramines. A review with 93 refs of the chemistry of nitramines is reported by Lamberton (Ref)

Ref: A. H. Lamberton, Quart Revs **5**, 92-95 (1951) & CA **46**, 6081 (1952)

Hydroxyanilinobenzene-diazonium. See Anilino-benzenediazonium Hydroxide in Vol 1, p A421

Hydroxyanilinopropane. See Anilinopropanol in Vol 1, p A436-L

Hydroxyanthraquinone and Derivatives

1-Hydroxyanthraquinone, C₁₄H₈(CO)₂.C₆H₃.OH; mw 224.20. Two isomers of this formula are known:

1-Hydroxy-, red-orn ndls (alc), mp 194-95°, bp - subl; sol in alc & v sol in eth. Can be prepd by heating phthalic acid anhydride with phenol in the presence of ZnCl₂ & HCl at 120-25° (Refs 1 & 3)

2-Hydroxy-, yel ndls (alc), mp 306-08°, bp - subl; v sl sol in w; sol in alc & eth. Can be prepd by diazotizing 2-aminoanthraquinone in HCl soln and boiling the diazonium sulfate soln (Refs 2 & 4)

Refs: 1) Beil **8**, 338, (650) & [388]
2) Beil **8**, 343, (658) & [393] 3) M. Copisaron, JChemSoc **117**, 214 (1920)
4) A.G. Perkin & T.W. Whattam, JChemSoc **121**, 289 (1922)

1-Hydroxy-4, 5, 8-trinitroanthraquinone (NO₂)₃C₆(OH)COCOC₆H₄, mw 359.20, N 11.10%, cryst, mp 245°. Prepd by treating the corresponding dihalogen or dinitro anthraquinone with a metal nitrite in an organic solvent

Refs: 1) P. Belshaw et al, USP 2,587,093 (1952) & CA **46**, 8679 (1952) 2) P. Belshaw et al, BritPat 670,720 (1952) & CA **46**, 10205 (1952)

Hydroxyazapropane Nitroso-Nitro Derivative. See NENA or N-(β-Nitrosoethyl)-nitramine in Vol 1 of Encycl, p A201-L

I-Hydroxy-III-azidoiminomethyl-triazene or N'-Hydroxy-N-azidoiminomethyl-triazene,
 HON:NNHC(:NH)N₃; mw 129.09, N 75.97%.

Inasmuch as this compound was never isolated in the free state but was prepd only in solution, its structure has not been definitely established. Hofmann et al (Refs 1 & 2) claimed that when they treated guanyldiazoguanyltetrazene (called by them simply "diazohydrate," but now known as "Tetracene") with KOH or NaOH in the presence of water, the insoluble Tetracene went into solution accompanied by the evolution of ammonia. When this solution was acidified, the original "Tetracene" was not recovered. When the alkaline solution of Tetracene was allowed to evaporate in a vacuum over concd H₂SO₄, an explosion took place while the mass was still wet

When an alkaline solution of Tetracene was acidified with dilute HNO₃ and then treated with an excess of AgNO₃, a pale-yellow ppt was obtained. This ppt was washed with a 3% solution of HNO₃ and the residue dissolved in a 2.5% solution of ammonia. The resulting solution with a pale yellow color gave, after evaporating the ammonia in vacuum over H₂SO₄ or on acidification by HNO₃, a white ppt which the authors called "Tetrazylazoimidesilber," N₃CH₄.Ag. This compound exploded violently when heated in water on a water bath. It also exploded when the incompletely dried material was touched with a feather

The same authors claimed that they prepd a copper salt of the following composition:

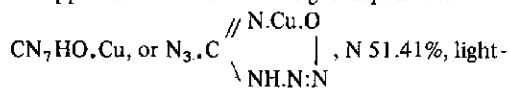

green plates

For preparation of this salt, they dissolved Tetracene in very dilute pure NaOH solution and then added immediately, without acidification, an excess of copper acetate solution. The resulting brownish ppt was separated and washed with 2-3% solution of acetic acid followed with water. On treating the ppt with 3% solution of ammonia, a blue solution was obtained, leaving a brown residue of copper cyanimide. When the blue filtrate was evaporated partly in vacuum over concd H₂SO₄ until the separation of a small amount of greenish plates was obtained, they proved to be a mixture of

the copper salt, CN₇HOCu, with other compounds, which Hofmann called "Amidotetrazotkupfer," but did not give a formula for it. The filtrate remaining was evaporated to dryness in vacuum over phosphorous pentoxide which gave thin plates, appearing sky-blue by reflected light and pale-green by transmitted light. The analysis gave Cu 32.84% and 33.85% and N 51.78%, which closely coincides with the composition; Cu 33.37%, N 51.41% of the formula CN₇HOCu

The dry copper salt is very sensitive to friction or impact, but it is insensitive when wet. It explodes violently on heating

When a solution of the copper salt in very dilute nitric or hydrochloric acid was evaporated to dryness on a water bath, a greenish powder remained. This residue is so sensitive that it exploded on being touched with a glass rod even when wet. It is presumed that this is the copper salt of Tetrazyl-azoimide, since it was converted to the corresponding silver salt, N₃·CN₄Ag

Refs: 1) Beil, 3 (60) 2) K. A. Hofmann et al, Ber 43, 1093 (1910)

Hydroxyazobenzene and Derivatives

Hydroxyazobenzene, HO·C₆H₄·N:N·C₆H₅; mw 198.22. Three isomers are known: *ortho* - orn ndls, mp 82.5-83° (Ref 1); *meta* - yel crystals, mp 114-15° (Ref 2); and *para* - orn crystals, mp 155-56° (Ref 3); all three sl sol in w; sol in alc & eth

Refs: 1) Beil 16, 90, (233) & [32] 2) Beil 16, 94 & {85} 3) Beil 16, 96, (233), [38] & {86}

Mononitrohydroxyazobenzene, C₁₂H₉N₃O₃; mw 243.22, N 17.28%. Several isomers are found in Beil:

5-Nitro-2-hydroxy-azobenzene,

HO·C₆H₃(NO₂)N:N·C₆H₅, orn-red pltlts (from dil acetic acid), mp 150-51° (Ref 1)

3-Nitro-4-hydroxy-azobenzene, lt-yel pltlts (from benz), mp 128° (Ref 2)

2'-Nitro-4-hydroxy-azobenzene,

HO·C₆H₄·N:N·C₆H₄·NO₂; dk-red ndls (from dil MeOH), mp 162-63° (Ref 3)

3'-Nitro-4-hydroxy-azobenzene, orn-yel crystals (from acet ac), mp 147-64° (Ref 3)

4'-Nitro-4-hydroxy-azobenzene, crystals (from alc or xylol), mp 219–219.5° (Ref 5)

Other props & methods of prepn are given in Refs

Refs: 1) Beil 16, 93 2) Beil 16, 123, (239) & [57] 3) Beil 16, 99, (234), [39] & {88} 4) Beil 16, 100, (235), [39] & {88}

Dinitrohydroxyazobenzene, C₆H₅N₂O₃; mw 288.22, N 19.44%. Four isomers are known:

2,3'-Dinitro-4-hydroxy-azobenzene, HO.C₆H₃(NO₂)₂:N:N.C₆H₄.NO₂; red crystals (from acet acid), mp 202° (Ref 4)
3,2'-Dinitro-4-hydroxy-azobenzene, brn-red crystals (from 1-ethoxy-2-ethanol), mp 190° (Ref 3)
5,4'-Dinitro-4-hydroxy-azobenzene, orn-colored crystals (from aq alc), mp 205–07° (Ref 1)
2',4'-Dinitro-4-hydroxy-azobenzene, HO.C₆H₄:N:N.C₆H₃(NO₂)₂; crystals (from MeOH), mp 185–86° (Ref 2)

Other props & methods of prepn are found in Beil

Refs: 1) Beil 16, {84} 2) Beil 16, {88} 3) Beil 16, {100} 4) Beil 16, {101}

Trinitrohydroxyazobenzene, C₁₂H₇N₅O₇; mw 333.22, N 21.02%. Two isomers are known:

4,6,4'-Trinitro-3-hydroxy-azobenzene, HO.C₆H₂(NO₂)₂:N:N.C₆H₄.NO₂; red ndls (from acet ac + w), mp 179°; was prepd by heating benzoquinone-(1,4)-oxime-4,6-dinitro-3-hydroxy-phenylhydrazone with nitric acid (d 1.39) & acetic acid (Refs 1 & 3). No expl props are reported

2',4',6'-Trinitro-4-hydroxy-azobenzene, HO.C₆H₄:N:N.C₆H₂(NO₂)₃; dk-red, blue colored ndls (from dil acetic acid), mp 194–95°; was prepd from 2,4,6-trinitrophenylhydrazine & benzoquinone-(1,4) in alc HCl (Refs 2 & 3). No expl props reported

Refs: 1) Beil 16, [37] 2) Beil 16, [40] 3) W. Borsche, Ber 54, 678 & 1287 (1921)

NOTE: No higher nitrated derivs of Hydroxy-azobenzene were found in the literature

5-Hydroxy-1,5'-azotetrazole.

$$\begin{array}{c} \text{N}=\text{N}-\text{N}-\text{N}=\text{N}-\text{C}=\text{N} \\ | \quad | \quad | \quad | \\ \text{N}=\text{C}.\text{OH} \quad \text{HN}=\text{N}=\text{N}; \text{mw } 182.12, \\ \text{N } 76.92\%; \text{ exists as Na salt, Na}_2\text{C}_2\text{N}_{10}\text{O}+5\text{H}_2\text{O}, \end{array}$$

yel pltlts, exploding violently on heating; and as Ba salt, BaC₂N₁₀O+4H₂O, yel crystals, just as expl as Ba salt. Salts can be prepd by passing CO₂ thru a boiling soln of either Na or Ba salt of 5-diazotetrazole

Refs: 1) Beil 26, 596 2) Thiele & Marais, Ann 273, 150 (1893)

Hydroxybenzaldehyde and Derivatives

Hydroxybenzaldehyde, HO.C₆H₄.CHO; mw 122.12.

Three isomers are known: *ortho* – or *Salicylaldehyde*, colorless liq or dark-red oil with bitter almond odor; combustible; fr p –7°, bp 196.5°, sp gr 1.153 at 25°/4; refr ind 1.5736 at 20°; v sl sol in w, v sol in alc & eth; can be prepd by the interaction of phenol & chl f in presence of aqueous alkalies. It is used in anal chem & perfumery (Refs 1, 4 & 5); *meta* – orn-pink crystals; mp 106–08° (Ref 1), bp ca 240°; sol in alc, benz, hot w & aromatic hydrocarbons. It is used as intermediate for dyes, plastics & pharmaceuticals and in anal chem (Refs 2, 3 & 4); *para* – colorless crystals, mp 116–17°; bp – subl; sol in alc, eth, acet, benz & w. It is used in pharmaceuticals (Refs 3, 4 & 5)
 Refs: 1) Beil 8, 31, (515), [35] & {135} 2) Beil 8, 58, (524), [52] & {197} 3) Beil 8, 64, (527), [63] & {215} 4) CondChemDict (1961), 592-L & 999-L 5) Ibid (1971), 771-R (ortho) & 458-L (meta & para)

ortho-Salicylaldehyde Azide or Salicylic Acid

Azide, HO.C₆H₄.CON₃; mw 163.13, N 25.76%; plates (from eth), mp 27°, extremely volatile; was obtd by action of ice cold fuming HNO₃ & NaNO₂ on salicylic acid hydrazide. No expl props recorded (Refs 1 & 2)

Refs: 1) Beil 10, 100 2) Struve & Radenhausen, JPraktChem [2] 52, 240 (1895)

4,6-Dinitro-3-hydroxybenzaldehyde gives dark crimson needles of **2,4,6-Trinitro-hydroxybenzaldehyde-[4-nitro-phenylhydrazone]**, O₂NC₆H₄NN:CC₆H(NO₂)₃OH; which explode at 228–30°. Its **p-Bromophenylhydrazone**, deep olive green crystals with a metallic luster, also explodes violently at 218–20°. The **p-nitrophenylhydrazone** derived from **2,6-dinitrohydroxybenzaldehyde**, deep terra cotta crystals, explodes at 240–42°, but the corresponding *p-bromophenyl-*

hydrazone is not explosive. Many other phenylhydrazone derivatives are known but although they are unstable to heat they do not appear to be explosive (Ref 2)

Refs: 1) Beil 15 [199] 2) H.H. Hodgson & H. G. Beard, JChemSoc 1927, 2375 & CA 22, 64 (1928)

Many nitro derivs of hydroxybenzaldehyde are known (See Beil 8, 56-7, 62-3, 83 & [63]) but none of these is explosive, even the trinitro derivative, $(\text{NO}_2)_3\text{C}_6\text{H}(\text{OH})\text{CHO}$, although it melts (161°) with decomposition. However reacting the latter with hydrazine sulfate produces the explosive:

Azin of 2,4,6-trinitro-3-hydroxy-benzaldehyde, also called **2,4,6,2',4',6'-Hexanitro-3,3'-dihydroxybenzadazin** (also called Azin des 2,4,6-Trinitrobenzaldehyds in Ger). $[\text{HOC}_6\text{H}(\text{NO}_2)_3\text{CH:N}]_2$; mw 510.28, N 21.96%, OB -53.0%; in the form of bright yellow needles that are sol in alc or 50% HAc, but insol in benz. Prepd by treating 2,4,6-Trinitro-3-hydroxybenzaldehyde in hot aq NaOH with hydrazine sulfate

Refs: 1) Beil 8, [63] 2) H.H. Hodgson & H.G. Geard, JChemSoc 1927, 2379

Hydroxybenzazide or Hydroxybenzoylazide.

See under Hydroxybenzoic Acid and Derivatives in this Vol

Hydroxybenzene. See Phenol or Carboic Acid

Hydroxybenzenearsonic Acid and Derivatives

Hydroxybenzenearsonic Acid (called Oxyphenylarsonsäure in Ger), $\text{HO.C}_6\text{H}_4\text{AsO}(\text{OH})_2$; mw 218.03. Three isomers are known:

2-Hydroxybenzenearsonic Acid, ndls (from w), mp $190-91^\circ$; readily sol in water, MeOH & alc; insol in eth (Ref 1)

3-Hydroxybenzenearsonic Acid, crystals (from w), mp $159-73^\circ$; sol in w, MeOH, alc & glac acet acid; insol in chl f & benz (Ref 2)

4-Hydroxybenzenearsonic Acid, crystals or ndls (from hot acet), mp $177-78^\circ$; sol in w, alc & dil mineral acids; sl sol in eth & eth acet (Ref 3)

Other props & methods of prepn are found in Beil
Refs: 1) Beil 16, (454) & [464] 2) Beil

16, (454) 3) Beil 16, 874, (455), [466] & {1070}

Hydroxybenzenearsonic Acid and Derivatives

Hydroxybenzenearsonic Acid (called Oxyphenylarsonsäure in Ger), $\text{HO.C}_6\text{H}_4\text{AsO}(\text{OH})_2$; mw 218.03. Three isomers are known:

2-Hydroxybenzenearsonic Acid, ndls (from w), mp $190-91^\circ$; readily sol in water, MeOH & alc; insol in eth (Ref 1)

3-Hydroxybenzenearsonic Acid, crystals (from w), mp $159-73^\circ$; sol in w, MeOH, alc & glac acet acid; insol in chl f & benz (Ref 2)

4-Hydroxybenzenearsonic Acid, crystals or ndls (from hot acet), mp $177-78^\circ$; sol in w, alc & dil mineral acids; sl sol in eth & eth acet (Ref 3)

Other props & methods of prepn are found in Beil

Refs: 1) Beil 16, (454) & [464] 2) Beil 16, (454) 3) Beil 16, 874, (455), [466] & {1070}

Mononitrohydroxybenzenearsonic Acid,

$\text{C}_6\text{H}_5\text{NO}_6\text{As}$; mw 263.03, N 6.20%. Many mono nitro derivs are found in Beil

Ref: Beil 16, (454, 455, 456), [465, 466, 468, 469] & {1070, 1073}

Dinitrohydroxybenzenearsonic Acid,

$(\text{O}_2\text{N})_2\text{C}_6\text{H}_2\text{AsO}(\text{OH})_2$; mw 308.03, N 9.16%. Two derivs are found in the literature:

3,5-Dinitro-2-hydroxybenzenearsonic Acid, yellow ndls (from w), mp $244-46^\circ$; prepd by diazotizing picramic acid with Na arsonite in alc soln; forms crystals & amorph salts (Ref 1)

3,5-Dinitro-4-hydroxybenzenearsonic Acid, yellow crystals (from w), mp $>275^\circ$ w/o melting, d 2.0565 at 20° ; dec on heating in a flame; an expl which liberates a poisonous gas (AsH_3). It can be prepd by nitrating 4-hydroxybenzenearsonic acid Na salt with 4 moles of nitric acid (d 1.52) in concd sulfuric acid at $15-20^\circ$ (Ref 2)

A lab expln took place when a thick wet cake of the compd was heated in a flask (Ref 3). Some work done in Phillip's Lab indicates that the acid as well as its salts might prove to be as expl as PA to which it is closely related

Refs: 1) Beil 16, (454) & [465] 2) Beil 16, (457), [470] & {1075} 3) M.A. Phillips, Chem & Ind 1947, 61 & CA 43, 2437 (1949) 4) No further refs found in CA thru 1971

NOTE: No higher nitrated derivs of Hydroxybenzeneazonic Acid were found

Hydroxybenzeneazonaphthol and Derivatives

Hydroxybenzeneazonaphthol (called Phenol-azo-naphthol in Ger), $C_{16}H_{12}N_2O_2$; mw 264.27, N 10.60%. Four isomers are known:

1-(2-hydroxybenzeneazo)-2-naphthol,

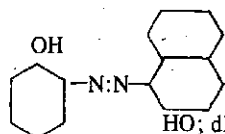

HO; dk-violet crystals (from alc or eth acet), mp 193° (Ref 1); forms numerous metal salts

1-(3-hydroxybenzeneazo)-2-naphthol,

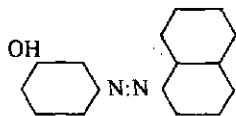

HO; red-brn powd, mp $231-33^\circ$; forms a Cu salt (Ref 2)

1-(4-hydroxybenzene)-4-azo 1)-2-naphthol,

HO N:N.C₁₀H₆.OH; red crystals, ndls (from MeOH), pltlts (from alc) or dk-violet ndls (from alc + benz), mp 194° ; forms Cu & Ni cryst salts (Ref 3)

1-(4-hydroxybenzene)-4-azo 4)-1-naphthol,

HO N:N.C₁₀H₆.OH; pltlts, mp — not reported; readily sol in alkalies giving a dk red color (Ref 4)

Other props & methods of prepn are found in Beil

Refs: 1) Beil 16, 169, (262) & {141}

2) Beil 16, {144} 3) Beil 16, 170, (264) & [74] 4) Beil 16, 158

Mononitrohydroxybenzeneazonaphthol,

$C_{16}H_{11}N_3O_4$; mw 309.27, N 13.59%. Several isomers are known:

5-Nitro-1-hydroxybenzene-(2-azo 1)-2-naphthol,

N:N.C₁₀H₆.OH; purple-red crystals, mp 228° ; sol in alc, glac acet ac & eth acet; sl sol in benz & chl; forms a K salt, $KC_{16}H_{10}N_3O_4$, green + bronze luster crystals (from alc), which explodes on heating (Refs 1 & 5)

4-Nitro-1-hydroxybenzene-(3-azo 1)-2-naphthol,

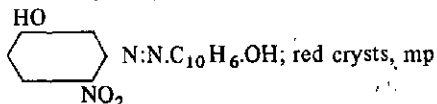

> 260° ; sol in H_2SO_4 ; v sl sol in org solvs (Ref 2)
2-Nitro-1-hydroxybenzene-(4-azo 1)-2-naphthol, red ndls (from Nitrobenz), mp 221° ; sol in benz & concd H_2SO_4 ; v sl sol in hot alc, eth & cold acet (Ref 3)

1-(5-Nitro-2-hydroxybenzeneazo)-2-naphthol,

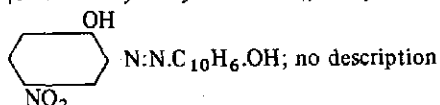

reported (Ref 4)

Other props & methods of prepn are found in Beil

Refs: 1) Beil 16, (263) 2) Beil 16, (264) 3) Beil 16, (265) & [74] 4) Beil 16, {143} 5) G.T. Morgan & J.W. Porter, JCS 107, 651-56 (1915) & CA 9, 2061-62 (1915)

Dinitrohydroxybenzeneazonaphthol, $C_{16}H_{10}N_4O_6$; mw 354.27, N 15.81%. Three isomers are found in Beil:

4,6-Dinitro-1-hydroxybenzene-(3-azo 1)-2-naphthol,

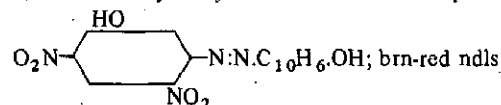

(from benz), mp $>260^\circ$; insol in alc; sol in concd H_2SO_4 giving a violet color (Ref 1)

2,6-Dinitro-1-hydroxybenzene-(4-azo 1)-2-naphthol,

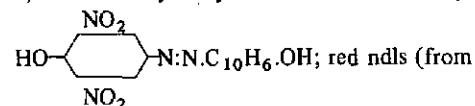

Nitrobenz), mp $269-70^\circ$; sol in alk; sl sol in alc; v sl sol in glac acet acid (Ref 2)

5-Nitro-1-hydroxybenzene-(2-azo 1)-4-nitro-2-naphthol,

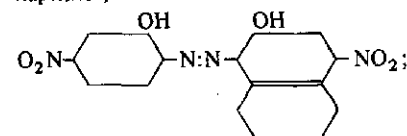

dk-brn, red crystals (from anisole), mp 132--66° (unsharp); sol in concd H₂SO₄ giving a red-violet color (Ref 3)

Other props & methods of prepn are given in Refs

Refs: 1) Beil 16, (264) 2) Beil 16, 171
3) Beil 16, (268)

2,4,6-Trinitro-1-hydroxybenzene-(3 azo 1)-2-naphthol,

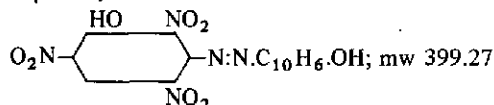

N 17.54%; brownish crystals (from Nitrobenz), mp - not reported; sol in concd H₂SO₄ with blue color; sol in dil NaOH with dk-red color; the alkaline soln decomp on warming gently. It was prepd by coupling the diazotized salt of 2,4,6-Trinitro-3-aminophenol with β-naphthol in glac acet ac + concd sulfuric acid (Refs 1 & 2). No expl props are reported

Refs: 1) Beil 16, [73] 2) E. Misslin, Helv 3, 637 (1920)

NOTE: No higher nitrated derivs of Hydroxybenzeneazonaphthol were found in the literature

Hydroxybenzoic Acid and Derivatives

Hydroxybenzoic Acid, HO.C₆H₄.COOH; mw 138.12. Three isomers are known: *ortho* or *Salicylic Acid*, colorless, combustible, monocl crystals (from w) or pdr of sweetish taste; sp gr 1.443 at 20°; mp 158.3° (subl at 76°), bp ca 211° at 20mm; v sl sol in w; sol in alc, eth, acetone, oil or turpentine. Prepd by treating hot soln of Na phenolate with CO₂ and acidifying the Na salt thus formed. Used as org intermediate and for manuf of *aspirin* (See Vol 1, p A87) & other medicinals. Its dust forms an expl mixt with air (Refs 1, 4 & 5); *meta*, colorless crystals, sp gr 1.473, mp 200-01°; sol in w, eth & hot alc. Can be prepd by passing light thru a hot suspension of 3-hydroxybenzaldehyde in NaOH. Used as intermediate for plasticizers, in resins and as petroleum additives (Refs 2 & 4); *para*, colorless crystals, sp gr 1.468 at 4°; mp ca 215° (Lange); 210° (Ref 4); sol in w, alc & eth. Prepd by interaction of *p*-aminobenzoic acid with nitrous acid. Used as intermediate and for prepn of synthetic drugs (Refs 3 & 4)

Refs: 1) Beil 10, 43, (20), [25] & {87}
2) Beil 10, 134, (63), [79] & {242}
3) Beil 10, 149, (68), [88] & {277}
4) CondChemDict (1961), 592-R & 997-L
5) Ibid (1971), 771-R (ortho) & 458-R (meta & para)

Hydroxybenzoic Acid Azide, Hydroxybenzazide or Hydroxybenzoyl Azide, HO.C₆H₄CO.N₃; mw 163.13, N 25.76%. Three isomers are known: *2-Hydroxybenzoyl Azide or Salicylic Acid Azide*, plts (from eth), mp 27°, extremely volatile; was prepd from salicylic acid hydrazide by action of an ice-cold soln of aq HNO₃ & NaNO₂ (Refs 1 & 4)

3-Hydroxybenzoyl Azide, crystals (from alc + w), mp 95°; sol in alc, eth & chl; sl sol in petr eth; prepd by nitrating 3-hydroxybenzhydrazide with H₂SO₄ & NaNO₂ (Refs 2 & 4)

4-Hydroxybenzoyl Azide, ndls (from alc + w), mp 132°; was prepd by action of NaOH, NaNO₂ & acetic acid on 4-hydroxybenzhydrazide (Refs 3 & 4)

No expl props were reported for the above azides

Refs: 1) Beil 10, 100 2) Beil 10, 142
3) Beil 10, 175 4) Struve & Radenhausen, JPraktChem [2] 52, 240, 235, 237 (1895)

5-Nitro-3-hydroxybenzoyl Azide (called 5-Nitro-3-oxy-benzazid in Ger), HO.C₆H₃(NO₂)CO.N₃; mw 208.15, N 26.92%, OB to CO₂ -92.2%; red-yel flocculent ppt, mp - deflgr on heating; insol in w; sol in alc or eth. Prepd from 5-nitro-3-aminobenzhydrazide in acet acid + aq NaNO₂ (Refs 1 & 2)

Refs: 1) Beil 10, 147 2) T. Curtius & A. Riedel, JPraktChem [2] 76, 260 (1907)

Hydroxybenzoic Acid, 3-Chloro-5-diazo or 5-Diazo-3-Chloro-Hydroxybenzoic Acid (called 3-chlor-5-diazo-salicylsäure in Ger).

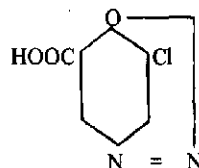

mw 198.57, N 14.11%; yel scale-like crystals (from glac HAC); v sl sol in water or alc.

Prepd from 3-chloro-5-amino-salicylic acid and Na-nitrite in dil HCl. Explodes at 193°

Refs: 1) Beil 16, (369) 2) R. Meldola et al, JChemSoc 111, 543 (1917)

Hydroxybenzoic Acid, 4-Diazo or 4-Diazo-3-chloro-hydroxybenzoic Acid, [called Anhydro-(3-oxy-benzoësäure-(4) in Ger],

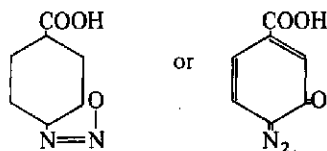

mw 164.12, N 17.07%; yel powd, mp - very unstable; prepd by diazotizing 4-amino-3-hydroxybenzoic acid (Refs 1 & 2)

Refs: 1) Beil 16, (369) 2) R. Mellet, Chem-Ztg 34, 1073 (1910)

Hydroxybenzoic Acid, 3-Diazo-5-nitro or 3-Diazo-5-Nitro-Hydroxybenzoic Acid (called 5-Nitro-3-diazo-salicylsäure in Ger).

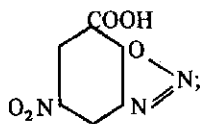

mw 209.13, N 20.10%, OB to CO₂ -80.3%; yel ndls (from alc); turns brown at 100°, decomp at 145-150°, explodes on rapid heating. Prepd by reacting 3-amino-salicylic acid with Na-nitrite in HCl. Infra-red spectra confirm diazonium structure shown above (Ref 2). Its lead salts also have this structure. They are light yellow, sparingly sol in org solvents, and are sensitive to impact, friction & flame

Refs: 1) Beil 16, (368) 2) B. Glowiak, Bull acad polon sci, ser, sci, chim, geol et geograph 8, 1 (1960) & CA 54, 12019 (1960)

The mono & dinitro derivatives of *hydroxybenzoic acid* are stable, non-explosive compounds (Refs 1, 3 & 4)

Refs: 1) Beil 10, 183, (52, 80) & [85, 108] 2) R. Schmitt, SS 38 11 (1943) & CA 38, 2822 (1944) 3) H. Goldstein & R. Staum, HelvChim Acta 35, 1470 (1952) & CA 47, 4859 (1953)

Some of the salts of the *dinitro* derivative are explosive:

2-Bromo-4,6-Dinitro-Hydroxybenzoic Acid, Calcium Salt. Ca[OOC₆H(OH)(Br)(NO₂)₂]₂

It is prepd by nitrating 2,4,6-Tribromo-3-hydroxybenzoic acid with nitric acid and neutralizing with Ca-hydroxide (Ref 1)

3,5-Dinitro-4-Hydroxybenzoic Acid, Copper Salt. Cu[OOC₆H₂(OH)(NO₂)₂]₂·3H₂O; green crystals, starts to decompose at 110° when heated slowly (Ref 6), loses water at 180° & explodes violently at 320° (Ref 2). It also explodes on rapid heating (Ref 6). Prepd by action of CuAc on Dinitrohydroxybenzoic acid

3,5-Dinitro-4-Hydroxybenzoic Acid, Lead Salt. Pb[OOC₆H₂(OH)(NO₂)₂]₂·3H₂O; mw 715.50, N 7.83%; yellow ndls (from water or dil HAc), sl sol in water. Prepd by reaction of Pb-nitrate and Dinitrohydroxybenzoic Acid (Refs 2 & 5). It explodes violently on rapid heating (ref 6) and is claimed to be as shock-sensitive as Mercuric Fulminate (Ref 3). Its use as a primary explosive has been claimed in Ref 4
Refs: Beil 10, 148 2) Beil 10, [69] 3) J. Burns, USP 1,928,780 (1932) & CA 27, 5981 (1933) 4) W. Bruen, USP 2,021,497 (1936) & CA 30, 618 (1936) 5) M. Schaefer, MP 27, 153 (1937) & CA 31, 7864 (1937) 6) J. Nevole, Ber 77B, 61 (1944) & CA 39, 288 (1945)

2,4,6-Trinitro-3-hydroxybenzoic Acid, (called Trinitro-oxy-benzoësäure in Ger).

HOC₆H(NO₂)₃COOH; mw 273.13, N 15.39%, OB -38.2%; shiny crystals (from conc nitric acid), platelets and prisms, containing 1 mole H₂O (from w), mp ca 105° (loses water) of hydrated compd, 186° of anhydrous, darkens at 200° & puffs off on rapid heating; sol in water, alc or eth, sl sol in benz. Prepd by heating diazoaminobenzoic acid with concd nitric acid, or reacting 3-amino-benzoic acid with fuming nitric acid (Ref 1). It is quantitatively precipitated by a phenylacridine soln (Ref 3)

The *Barium, Copper and Lead salts of Trinitrohydroxybenzoic acid* are explosive:

Barium Salt. Ba[OOC₆H(NO₂)₃(OH)]₂·2H₂O; yellow needles; very explosive (Ref 1)

Copper Salt. Cu[OOC₆H(NO₂)₃(OH)]₂·5H₂O; green needles; explodes at 299° or on rapid heating (Ref 1)

Lead Salt. Pb[OOC₆H(NO₂)₃OH]₂. Schmitt determined the ignitability of pellets of this salt (Ref 2). On exposure to flame, pellets pressed at 500 kg/cm² detonated, while pellets

pressed at 1000, 2000 or 3000 kg/cm² merely burned

See Dead-Pressed Explosives in Vol 3, p D20-L. Ficherouille & Kovache claim that this salt is not useful as an explosive primer (Ref 4)

Refs: 1) Beil 10, 148-49 & (67-8) 2) R. Schmitt, SS 38, 133 (1943) & CA 38, 2823 (1944) 3) Ibid, p 149 4) H. Ficherouille & A. Kovache MP 31, 7 (1949) & CA 46, 11686 (1952)

Hydroxybenzotriazole. See Benzotriazolol in Vol 2, p B87-R. Additional explosive derivatives of Benzotriazolol are described below:

1-Bromobenzo-3,4-(3'-azimidole), C₆H₄BrN₃O; mp 201.5-202.5°, sol in alkalis. Explodes on heating (Ref 1)

Vis (Ref 2) lists some other explosive derivatives of 1-hydroxy-1,2,3-benzotriazole, for example:

4,6-Dichlor-1-hydroxy-1,2,3-benzotriazole, mp 193°; powerful explosive

Hydrazine salt of the above compound, mp 186-93°; explodes violently on heating

4,6-Dibrom-1-hydroxy-1,2,3-benzotriazole, mp 222°; powerful explosive

Hydrazine salt of the above compound, mp about 222°; very explosive

Hydrazine salt of 4-nitro-6-chlor-1-hydroxy-1,2,3-benzotriazole, orange-yellow amorphous solid; very powerful explosive

Goldstein & Voegeli (Ref 3) describe:

3-Hydroxybenzotriazole-5-carboxylic acid, decomp 225°; deflagrates at 245-7°

Refs: 1) A. Mangini, Gazz Chim Ital, 66, 675-84 (1936) & CA 31, 4961 (1937) 2) B. Vis, Rec Trav Chim, 58, 847-55 (1939) & CA 33, 8612 (1939) 3) H. Goldstein & R. Voegeli, Helv Chim Acta, 46, 475-81 (1943) & CA 37, 5709 (1943)

Hydroxy-6-nitro-1,2,3-benzotriazole-5-acetic Acid. See under Benzotriazolol in Vol 2, p B88-R

Hydroxybenzylaniiline, Tetranitro Derivative

(called Tetranitro [2-oxy-benzyl-anilin] in Ger). xxxx(NO₂)₄(OH)C₆H₂CH₂NHC₆H₃; mw 379.27, N 18.47%; yellow ndls (from benz), mp 66°

(decomp); insol in water; sol in alc, benz or ligroin. Prepd by mixed acid nitration of 2-hydroxybenzylaniiline

Ref: Beil, 13, 580

Hydroxybenzyltoluidine, Tetranitro Derivative

{called Tetranitro [(2-oxy-benzyl)-p-toluidin] in Ger}. xxxx(NO₂)₄(OH)C₆H₂CH₂NHC₆H₂(CH₃);* mw 393.30, N 17.81%; yellow ndls (from benz), mp 168°; sol in alc or benz; insol in water.

Prepd by mixed acid nitration of 2-hydroxybenzyl-p-toluidine. Explodes on rapid heating

*Note: Position of NO₂ groups has not been determined. Consequently, the number of H groups on each benzene ring is also uncertain

Ref: 1) Beil, 13, 581 2) Not found in CA, 1957-71

α-Hydroxybibenzyl or α,β-Diphenyl-β-hydroxyethane. Its pentanitro deriv is:

2,4,2',4',5'-Pentanitro-α-hydroxybibenzyl or α-2,4,5-Trinitrophenyl-β-2',4'-dinitrophenyl-β-hydroxyethane.

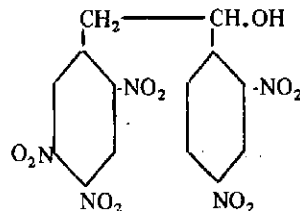

mw 423.25, N 16.55%; pale cream needles (from toluene), mp 187.3°; v sl sol in alc or eth; appreciably sol in benz, toluene, acetone, ethylene dichloride & acetylene tetrachloride. It was prepd by adding tetranitro-diphenylamine to fuming sulfuric acid at 85° for 4 days, after cooling fuming nitric acid (95%) was added and the temp was raised slowly and maintained at 85° for two days. The separated solid was collected, washed with alc & recrystallized from toluene

The compd exploded in 5 secs when heated to 360°, and exploded at 18 inches when impacted with a 2 kg wt. It could not be detonated with 0.4g of MF, but when initiated with 0.25g of Tetryl & 0.25g MF in the sand test, it crushed 21g of sand (Ref)

Ref: W.H. Rinkenbach & H.A. Aaronson, JACS 52, 5042-44 (1930) & CA 25, 508 (1931)

Hydroxybutyl and Derivatives. See Butanol and Derivatives in Vol 2, p B372-R

Hydroxychlorophenyl and Derivatives. See Chlorophenyl and Derivatives in Vol 3, p C362-L

3-Hydroxycumarone-2-azide. See 2-Azide-3-coumaranone in Vol 3, p C548-L

1-Hydroxycyclohexyl-1-hydroperoxide and 1-Hydroxy-1'-hydroperoxidecyclohexylperoxide. See under Cyclohexanone Peroxide in Vol 3, p C598-L

2-Hydroxy-1,1,3,3-Cyclopentanetetramethanol-pentanitate.

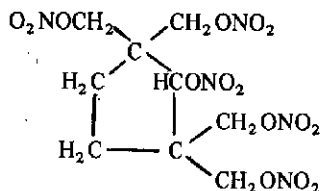

mw 431.23, N 26.24%, OB to CO₂ -35.2; mp 90.5. Prep'd by mixed acid nitration of 2-hydroxy-1,1,3,3-cyclopentanetetramethanol. It is a powerful explosive only slightly weaker than RDX: ballistic mortar 151%TNT vs161%TNT for RDX. It is slightly less impact & friction sensitive than RDX and has unsatisfactory vacuum stability (12-15ml at 100° in 12 hrs) (Ref 1). Its lowest explosion temp is 200° (Ref 2)

Refs: 1) D. C. Downing, *CanJChem* **30**, 124 (1952) & *CA* **47**, 8663 (1953) 2) H. Henkin & R. McGill, *IEC* **44**, 1391 (1952) & *CA* **46**, 8858 (1952)

Hydroxydialkylamines, Nitrated Derivatives.

Compounds of the general formula

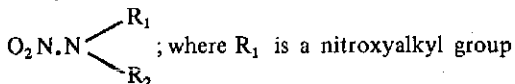

and R_2 is either a nitroxyalkyl or an alkyl group (alicyclic, cyclic or substituted) were proposed as explosive, essentially non-volatile, plasticizers for NC used in prepn of double-base propellants

Typical examples of this type of nitramine

are DINA, EtNENA, MeNENA and Me₂NENA. They are described separately

Ref: A.T. Blomquist & F.T. Fiedorek, *USP* 2678946 (1954) & *CA* **49**, 4704 (1955)

7-Hydroxy-2,5-diazaheptane. See N-Ethanol-N'-methyl-ethylenediamine in Vol 6, p E183-L

Hydroxydichlorobenzene and Derivatives. See Dichlorophenol and Derivatives in Vol 5, p D1213-R

Hydroxydiethylperoxide. See Ethylethanolperoxide in Vol6, p E294-L

Hydroxydimethylperoxide. (Called methyl-oxyethyl-peroxid in Ger). CH₃OOCH₂OH, mw 78.07, OB -82%; colorless oil of penetrating odor, will not freeze in ice-salt mixture, bp 45° at 17 mm; d 1.11 at 15°, refract index 1.398 at 15°; sol in water, alc, eth, benz & pet eth. Prep'd by reacting methylhydroperoxide with formaldehyde in ether. Explodes on heating above 50° & decomposes on long storage. Claimed to become impact sensitive on heating (Ref 3)

Refs: 1) Beil **1**, [641] 2) A. Rieche & F. Hitz, *Ber* **62B**, 2458 (1929) & *CA* **24**, 1079 (1930) 3) See table under **Hydroperoxides** in this Vol

2-Hydroxy-3,5-dinitrophenyl Azide or 2-Azido-4,6-dinitrophenol.

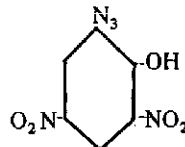

mw 225.12, N 31.11%; prep'd from diazodinitrophenol & Na Azide. Its alkali or alkaline earth metal salts are used with various admixtures, such as basic Pb Trinitroresorcinate, barium nitrate, Sb sulfide, Pb sulfocyanate & ground glass, for use as priming compns to initiate expls (Refs)

Refs: 1) J.D. McNutt, *USP* 1906394 (1933) & *CA* **27**, 3612 (1933); *USP* 1930653 (1934) & *CA* **28**, 328 (1934); & *USP* 2005197 (1935) & *CA* **29**, 5274 (1935) 2) A. H. Blatt & F. C. Whitmore, *OSRD* **1085** (1942), p 54 3) Blatt, *OSRD* **2014** (1944) (Under Azides)

Hydroxydiphenylamine. See Anilinophenol in Vol 1, p A433-R and additional entries below:

Hydroxy-tetranitro-diphenylamine (called 3,5,2',4'-Tetranitro-oxy-diphenylamin in Ger). $(O_2N)_2C_6H_3NHC_6H_2(NO_2)_2(OH)$, mw 365.22, N 19.18%, yellow powder, mp 236°, almost insol in all usual solvents. Prepd by condensation reaction of 4-chloro-1,3-dinitro-4 aminophenol in alc containing NaAc. No explosive props mentioned
Ref: 1) Beil 13, 528 2) Not found in CA thru 1971

4-Hydroxy-3,5,2',4',6'-Pentanitrodiphenylamine (Also called 2,6-Dinitro-4-Picrylaminephenol in Ger). $(O_2N)_3C_6H_2NHC_6H_2(NO_2)_2OH$; mw 410.22, N 20.49%, OB to CO_2 -62.4%; ochre-yel crystals (from HAC), mp 248°; insol in water, sl sol in alc; sol in alkalis with formation of a deep-brown color. Prepd by heating picryl chloride, isopicraminic acid & NaAc in aq alc. No explosive props are mentioned for it nor for the tetranitro derivatives (Ref 2). The Na salt, of the pentanitro derivative $NaC_{12}H_5O_{11}N_6$, red platelets, explodes above 300°. The 3'-Hydroxy-4-methyl-pentanitro diphenylamine is not explosive (Ref 3)
Refs: 1) Beil 13, (191) 2) Beil 13, 396, 528 & 531 3) Beil 13, 412

N-Hydroxyethenylamidooxime. See under Ethenylamidooxime in Vol 6, p E185-L

Hydroxyethyl. See Ethanol and Derivatives in Vol 6, p E154-L

Hydroxyethylamine and Derivatives. See under Amino-ethanol and Derivatives in Vol 1, pp A200-202

β -Hydroxyethylaminobenzene or β -Hydroxy-ethylaniline. See under 2-Anilinoethanol and Derivatives in Vol 1, pp A424-31. This includes Pentryl (Trinitroanilinoethanol Nitrate) & various halogen derivs of anilinoethanol

N-(2-Hydroxyethyl)-butylamine. Its nitrated deriv **N-(2-Nitroxyethyl)-butylnitramine (BuNENA)**, $O_2NO.CH_2.CH_2.N(NO_2).C_4H_9$; mw 207.19, N 20.28%; pale yel oil, frp -9.9°, RI 1.4750 at 20°, was prepd & described by Blomquist & Fiedorek (Ref)

Ref: A.T. Blomquist & F.T. Fiedorek, USP 2485855 (1949), pp 6 & 14 & CA 44, 3516-17 (1950)

Hydroxyethylcelluloses. Title of a doctorate thesis submitted to the University of Paris, France, 9 June 1960, 89pp & 144 refs
Ref: J. Quinchon, "Contribution à l'étude des hydroxyethylcelluloses," MP 42, (1960)

N-(2-Hydroxyethyl)-cyclohexylamine. Its nitrated deriv **N-(2-Nitroxyethyl)-cyclohexylnitramine (Cyclohexyl-NENA)**,

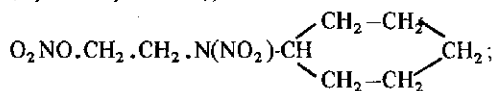

mw 233.22, N 18.02%; is described in Vol 3, p C600-L

N-(2-Hydroxyethyl)-ethylamine. Its nitrated deriv **N-(2-Nitroxyethyl)-ethylnitramine (EtNENA)**, $O_2NO.CH_2.CH_2.N(NO_2).C_2H_5$; mw 179.14, N 23.46%; pale yel oil, frp 4-5.5°, d 1.32 at 25°, RI 1.479 at 25°; prepd by addg ethylethanamine dropwise to a stirred 98% nitric acid soln at 10° and adding the resulting mixt to a soln of acetic anhydride & acctyl chloride at 35° (Ref)
Ref: A.T. Blomquist & F.T. Fiedorek, USP 2485855 (1949), pp 5 & 11-12; USP 2678946 (1954), pp 13 & 44

N-(2-Hydroxyethyl)-gluconamide Hexanitrate. $C_6H_5(ONO_2)_5CONHCH_2CH_2ONO_2$; mw 520.26, N 18.85%, OB to CO_2 -12.3%; prepd by nitric acid nitration N-2-hydroxyethylgluconamide, $C_5H_6(OH)_5CONHCH_2CH_2OH$. Claimed to be useful in blasting cap charges
Ref: W.F. Filbert, USP 2443903 (1948) & CA 43, 1796 (1949)

N-(2-Hydroxyethyl)-glycolamide Dinitrate. $O_2NOCH_2CONHCH_2CH_2ONO_2$; mw 209.12, N 20.10%, OB -34.4%; prepd by nitric acid nitration of N-2-hydroxyethylglycolamide, $HOCH_2CONHC_2H_5OH$. Claimed to be useful as a blasting cap charge
Ref: W.F. Filbert, USP 2443903 (1948) & CA 43, 1796 (1949)

Hydroxyethylglycolurethane, N-Nitro-Dinitrate.
 $O_2NO_2CH_2CH_2\overset{O}{C}N(NO_2)CH_2CH_2ONO_2$; mw

284.14, N 19.72%, OB -22.4%; white crystals. Prepd by nitrating N-hydroxy-ethylglycolurethane with 98% nitric acid. No properties given
 Ref: G. Desseigne, FrP 1094959 (1955) & CA 53, 11159 (1959)

Hydroxyethylguanidine and Derivatives

Hydroxyethylguanidine [called β -Guanidino- α ethylalcohol or (2-Hydroxy- α ethyl)-guanidin in Ger] $\text{NH}_2\text{CH}_2\text{CH}_2\text{OH}$



mw 103.13, N 40.75%; exists in the form of its salts. May be considered as the parent compd of its nitrated derivs, although not used to prep them

Ref: Beil, 4, [730] & [710]

N-(β -Hydroxyethyl)-N'-nitroguanidine or 1-(2-Hydroxyethyl)-3-nitroguanidine.

$\text{HOCH}_2\text{CH}_2\text{NH}_2\text{C}(\text{NH})\text{NHNO}_2$; mw 148.13, N 37.83%; wh crystals (from alc), mp 118° (dec); was obtd when methylnitrosoguanidine was added portionwise to a soln of ethanolamine in water cooled to 5-10°

Refs: 1) Beil, not found 2) A.F. McKay & J.E. Milks, JACS 72, 1617-18 (1950) & CA 44, 10661 (1950)

N-(β -Nitroxyethyl)-N'-nitroguanidine or 1-(2-Nitroxyethyl)-3-nitroguanidine.

$\text{O}_2\text{NOCH}_2\text{CH}_2\text{NH}_2\text{C}(\text{NH})\text{NHNO}_2$; mw 193.13, N 36.26%; crystals (from 95% alc), mp 161° (dec), explodes by impact. The compd was prepd by suspending β -Hydroxyethylnitroguanidine in acetic anhydride and adding dropwise 99% nitric acid at -5° for 10 mins. The compd explodes by impact (Ref 2)

Refs: 1) Beil, not found 2) R.C. Elderfield, OSRD 907 (1942) 3) A.F. McKay & J.E. Milks, JACS 72, 1618 (1950) & CA 44, 10661 (1950)

N-(β -Hydroxyethyl)-N-nitroso-N'-nitroguanidine or 1-(2-Hydroxyethyl)-1-nitroso-3-nitroguanidine.

$\text{HOCH}_2\text{CH}_2\text{N}(\text{NO})\text{C}(\text{NH})\text{NHNO}_2$; mw 177.13, N 39.54%; yel crystals (from MeOH), mp 111.5° (dec), unstable compd which decomposed on standing in the dark for 7 days; was obtd when β -Hydroxyethylnitroguanidine was dissolved in 70% nitric acid, diluted with water & Na

nitrate added to effect nitrosation

Refs: 1) Beil, not found 2) A.F. McKay & J.E. Milks, JACS 72, 1619 (1950) & CA 44, 10661 (1950)

N-(β -Nitroxyethyl)-N-nitroso-N'-nitroguanidine or 1-(2-Nitroxyethyl)-1-nitroso-3-nitroguanidine.

$\text{O}_2\text{NOCH}_2\text{CH}_2\text{N}(\text{NO})\text{C}(\text{NH})\text{NHNO}_2$; mw 222.13, N 37.84%; yel crystals (from 95% alc), mp 112.5° (dec); was prepd by nitrosation of N- β -Nitroxyethyl-N'-nitroguanidine

Refs: 1) Beil, not found 2) A.F. McKay & J.E. Milks, JACS 72, 1619 (1950) & CA 44, 10661 (1950)

N-(β -Nitroxyethyl)-N-nitro-N'-nitroguanidine or 1-(2-Nitroxyethyl)-1,3-dinitroguanidine.

$\text{O}_2\text{NOCH}_2\text{CH}_2\text{N}(\text{NO}_2)\text{C}(\text{NH})\text{NHNO}_2$; mw 238.13, N 35.30%; wh crystals (from MeOH), mp 84.5 to 85.3°; was prepd by addg β -hydroxyethylnitroguanidine to a nitration mixt of 99.8% nitric acid & acetic anhydride at 0° and after 30 mins pouring the mixt onto ice. This compd is useful in proplnts (Ref 3)

Refs: 1) Beil, not found 2) A.F. McKay & J.E. Milks, JACS 72, 1619 (1950) & CA 44, 10661 (1950) 3) A.F. McKay, USP 2538907 (1951) & CA 45, 4264 (1951); BritP 673709 (1952) & CA 46, 9123 (1952)

1-Hydroxyethyl Hydroperoxide.

$\text{CH}_3\text{CH}(\text{OH})\text{OOH}$, or its higher homologs are not explosive. See Table under **Hydroperoxides** in this Vol

N-(β -Hydroxyethyl)-hydroxyacetamide.

$\text{HOCH}_2\text{CONHCH}_2\text{CH}_2\text{OH}$; mw 119.12, crystals, mp 72.5-73.5°. May be prepd by treating methyl glycolate with monoethanolamine

A colorless oil was obtained when 2g of the compound were dissolved in 10ml of white nitric acid and then heated at 50-60° for one-half hour and poured on ice. This oil was not further investigated, but it might have been a liquid explosive, suitable as a plasticizer for NC etc
 Refs: 1) Beil, not found 2) R. Adams & C.S. Marvel, OSRD No 86 (1941), pp 12 & 36-37 3) CA not found thru 1971

N-(β -Hydroxyethyl)-methylamine. Its nitrated deriv **N-(β -Nitroxyethyl)-methylnitramine (MeNE-NA)**. $\text{O}_2\text{NOCH}_2\text{CH}_2\text{N}(\text{NO}_2)\text{CH}_3$; mw 165.11,

N 25.45%, OB to CO₂ -43.6%; crystals, mp 38-40°, d 1.53 at 25°; sol in acetic acid; sl sol in water; was prepd by nitrating the parent compd with nitric acid. The product is practically non-hygroscopic, its expln temp is 360°, impact value 90cm + (RDX = 48-50cm), power 136% TNT, and Vac Stab at 100° = 6.81cc/5g/48 hrs (Refs 1 & 2)

Refs: 1) A.T. Blomquist, OSRD 4134 (1944), pp 30-44, 72 & 110-11 2) A.T. Blomquist & F.T. Fiedorek, USP 2485855 (1949)

N-(β-Hydroxyethyl)-*N'*-methyl-ethylenediamine. Its nitrated deriv *N*-(β-Nitroxyethyl)-*N'*-methyl-ethylenedinitramine.

O₂NO·CH₂CH₂·N(NO₂)·CH₂·CH₂·N(NO₂)·CH₃; mw 253.18, N 22.64%; glistening crystals (from 50% acetone), mp 88.5-90°; was prepd by cleavage with 98% nitric acid of the compd iso-*N*¹,*N'*²-dimethyl-triethylenetetranitramine, H₃C·N(NO₂)·CH₂·CH₂·N(NO₂)·CH₂·CH₂·O·N·N·CH₂·CH₂·N(NO₂)CH₃, at 10°

Ref: A.T. Blomquist, OSRD 4134 (1944), pp 9 & 81

α-Hydroxyethylmethylperoxide or Methylhydroxyethylperoxide (α-Oxyäthyl-methyl-peroxyd in Ger). CH₃CH(OH)OOCH₃; mw 92.09, easily flowing oil, fairly stable; bp 29-31° at 22mm; d 1.029 at 15°, RI 1.3930 at 15°. May be prepd from methylhydroperoxide, CH₃OOH, and acetaldehyde, CH₃CHO; diff sol in water, miscible with alc and eth; easily sol in benz

Puffs off weakly on heating

Refs: 1) Beil, not found 2) A. Rieche & F. Hitz, Ber 63, 2642 (1930) & CA 25, 911 (1931)

N,N'-bis(2-Hydroxyethyl)-oxamide. See Diethylol-oxamide and Derivatives in Vol 5, p D1243-R

Hydroxyethyl-3-oxy-1,2-propanediol trinitrate or 3(β-Hydroxyethoxy)-1,2-propanediol trinitrate. ONO₂CH₂CH₂OCH₂CH(ONO₂)CH₂ONO₂, mw 271.18, N 15.50%, OB -26.5%. Prepd by mixed acid or straight nitric acid nitration of 3(β-Hydroxyethoxy)-1,2-propanediol (Ref 1) or nitrating the reaction product of epichlorohydrin & glycol (Ref 2). It is a liquid which is less volatile than NG. Desseigne has claimed its use as an explosive and as a gelatinizing agent

Desseigne also prepd in a similar manner Hydroxypropyl-3-oxy-1,2-propanediol Trinitrate. CH₃CH(ONO₂)CH₂OCH₂CH(ONO₂)CH₂ONO₂, and also claimed its use as an explosive and gelatinizing agent

Refs: 1) G. Desseigné, FrPat 1,127,647 (1956) & CA 53, 16970 (1959) 2) G. Desseigné, MP 39, 181 (1957) & CA 52, 21107 (1958)

Hydroxyethylpicramide, or 2,4,6-Trinitrophenyl-aminoethanol. See under Anilino-ethanol and its Derivatives in Vol 1, p A425-L

N-(β-Hydroxyethyl)-*N'*-phenyl-1,2-diaminoethane and Derivatives. See Anilinoethylaminoethanol and Derivatives in Vol 1, p A431-L

Hydroxyheptylperoxide. [CH₃(CH₂)₅CH(OH)]₂O₂; mw 262.38

The commercial product of the Lucidol Division contains a minimum of 95% of peroxide; active oxygen 5.8% (min). It is a white fine powder; mp 60-65°

It is insol in w and moderately sol in organic solvents or monomers. Unstable at ordinary room temp and should not be stored at above 70°F (in order to avoid loss of active oxygen) and away from all sources of heat. It should not be subjected to frictional heat or grinding. It has been used as a room or low temp catalyst for polymerization of polyester resins
Ref: Lucidol Division, Novadel-Agené Corp, Buffalo, NY, Organic Peroxides, Data Sheets No 18 (1948) and No 32 (1950)

1-Hydroxy-1'-hydroperoxy-dicyclohexyl peroxide. See under Cyclohexanone Peroxide in Vol 3, p C598-R

1-Hydroxy-5-hydroxymethyltetrazole and Derivatives.

1-Hydroxy-5-hydroxymethyltetrazole (called 1-Oxy-5-hydroxymethyltetrazol in Ger).

N—N.OH
|| \ C.CH₂OH; mw 116.08, N 48.27%, OB -55.1%. Prepd by treating 1-hydroxytetrazol with formaldehyde. It is a volatile material which is an explosive less powerful & brisant than PA (Ref 2)

Refs: 1) Beil 26 (109) 2) Blatt OSRD 2014 (1944)

1-Hydroxy-5-nitroxymethyltetrazole.

$$\begin{array}{c} \text{N}-\text{N.OH} \\ || \\ \text{N}-\text{N} \end{array} \text{C.CH}_2\text{ONO}_2; \text{mw } 161.08, \text{N } 43.48\%;$$

OB -14.9%. Prepd by nitrating above compd. It is less brisant and powerful than PA

Ref: Blatt OSRD 2014 (1944)

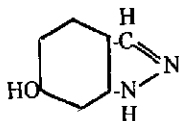
6-Hydroxyindazole (called 6-Oxyindazol in Ger).

mw 134.13, N 20.89%; leaflets, mp 215-16°; sol in dil acid or alkali, sl sol in water or eth. Prepd by diazotizing 6-aminoindazole. When nitrated it forms:

5,7-Dinitro-6-hydroxyindazole,

mw 224.13, N 25.00%; OB to CO₂ -78.5%, pale-yel leaflets (from glacial HAc); mp 232-33°; sol in water. Puffs off above mp

Refs: 1) Beil 23, 377 2) Not found in CA thru 1971

Hydroxymethylbenzene, Hydroxytoluene or Methylphenol. See Cresol and Derivatives in Vol 3, p C556-L

2-Hydroxymethyl-1,3-propanediol-2-aniline. See Anilinotrimethylolmethane and Derivatives in Vol 1, p A441. Its highly expl deriv, designated as **Heptryl** is on pp A441-R to A442-R

1-Hydroxy-2-propanone. See Acetol and Derivatives, in Vol 1, p A33-R

HYDROXYLAMINE AND DERIVATIVES

Hydroxylamine, Oxammonium (HA), NH₂OH, mw 33.03, N 42.3%, colorless, deliq low melt needles, mp 33°, bp 56.5° at 22mm, 110° at 760mm (Ref 8), flp explodes at 265°F, d 1.23, for liq RI 1.440 at 23.5°, sol in cold w, alc & acet; v sl sol in eth, chl & benz; decomp in hot w. ΔH_f° - 25.5, for cryst, -21.7, for soln,

kcal/mole (Ref 7). Dissoen const for dil soln 1.1 x 10⁻⁸; ΔH subl 15.3 kcal/mole (Ref 9)

It is an acute local irritant, and systemically it can cause methemoglobinemia (Ref 10)

Preparation

Since free NH₂OH is unstable it is usual to prepare it in the form of the hydroxylammonium salts, which resemble ammonium salts. A number of methods were proposed but only 5 offer practical methods

1) **Reduction of HNO₂ or its Salts.** When a soln of NaNO₂ is reduced by NaHSO₃, sodium hydroxylamine-N,N-disulfate is formed:

$$\text{NaNO}_2 + \text{NaHSO}_3 + \text{H}_2\text{SO}_4 \rightarrow \text{N}(\text{SO}_3\text{Na})_2\text{OH} + \text{H}_2\text{O}.$$
 Heating of the resulting soln produces hydroxylammonium hydrogen sulfate:

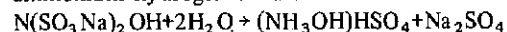

The crude hydroxylammonium salt may be obtained from the soln by fractional crystallization. Several modifications of the method exist (Ref 3)

2) **Reduction of Nitric Acid.** Electrolytic reduction of HNO₃ in the presence of HCl produces hydroxylammonia chloride:

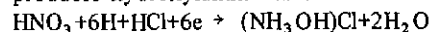

Yield ab 80% (Ref 2)

3) **Hydrolysis of primary nitroparaffins.** A primary nitroparaffin gives on hydrolysis with a strong acid, the corresponding fatty acid and the hydroxylammonium salt of the acid. For instance: CH₃CH₂NO₂ + H₂O + HCl → (NH₃OH)Cl + CH₃COOH. This reaction is used for producing hydroxylammonium salts industrially

Free NH₂OH may be liberated from any of the above salts, by a base stronger than hydroxylamine itself, eg K, Na, hydroxides or carbonates in aq or alc solns would liberate the base (Ref 4)

4) In the prepn of crystalline NH₂OH it is impractical to use a water solvent since it is difficult to remove it. It is better to use the anhydrous alcoholate of the corresponding solvent eg:

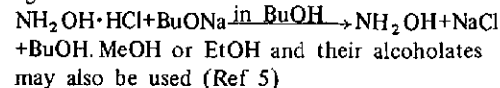

5) Similarly:

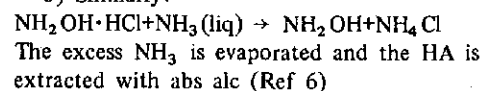

Removal of HA from the solvent alc is

achieved by cooling (the HA crystallizes) and/or addn of ether. Volatile alcs may be removed by vac distillation

Chemical Props

There is similarity in chem props between NH_2OH and hydrazine. HA may be regarded as hydroxylation product of ammonia, thus representing the first member of such series, which includes dihydroxyammonia and ortho nitrous acid. It may be regarded as ammonolyzed HOOH (Hydrogen Peroxide). Hydroxylamine, like NH and $\text{NH} \cdot \text{NH}$, forms a large group of salts, but only strong acids form stable salts, of which chlorides and sulfates are the best known. However, all of these salts decompose at about 150°

Like H_2O_2 and N_2H_4 , solns of the free base; NH_2OH , are susceptible to thermal and catalytic decomposition. It is not improbable that auto-oxidation and catalytic decomp reactions are catalyzed by traces of metallic ions, as has been noted in case of H_2O_2 and of N_2H_4 . The stability of HA is intermediate between hydrazine & hydrogen peroxide. It is less stable than N_2H_4 and somewhat more stable than H_2O_2 . Hydroxylamine is a highly hydrogen bonded subst in both the solid and liquid forms, but the vapor is a single molecule at low press (Ref 11). The latter studies give the bond strength of $\text{NH}_2\text{-OH}$ as 61.3 kcal/mole

NH_2OH very seldom exhibits acidic properties. It is claimed, however, that it forms unstable hydroxylamites, NaONH_2 , $\text{Ca}(\text{ONH}_2)_2$ (Ref 6). As a base NH_2OH resembles ammonia and other amines. Although its basic ionization constant is considerably lower than that of NH_3 and N_2H_4 it forms a series of ammonia-like inorg and org salts. In general, these salts are more stable than the parent base. Therefore, hydroxylamine is usually prep'd and shipped in the free form of its salts

NH_2OH also forms few double salts and coordination compds analogous to those formed by ammonia. Some of these compds are very stable to heat

Soln of HA, especially acidic solns are strong reducing agents. They will reduce FeCl_3 , ammonical AgNO_3 , CuSO_4 etc. In some instances, however, particularly in alkaline solns, HA is capable of oxidizing such subs as chromous chloride & CuOH

Liquid anhydrous NH_2OH will dissolve many

substances such as KI , KCN , KBr , NaNO_3 , $\text{Ba}(\text{NO}_3)_2$, NaCl , KCl , NaOH , $\text{Ba}(\text{OH})_2$, NH_3 (Ref 6)

Explosive & Combustion Props. NH_2OH , like N_2H_4 , is a strong reducing agent. The base ignites in a stream of chlorine and even reacts violently if air is blown through it

If it is heated in air, it explodes between 60 and 100° . It will explode upon contact with an open flame. On oxidation HA liberates a considerable amount of energy and may therefore be considered as a specialty fuel

A rough calculation of the overall heat of the reaction according to:

$$2\text{NH}_2\text{OH}(\text{gas}) + 1\frac{1}{2}\text{O}_2 \rightarrow 3\text{H}_2\text{O}(\text{gas}) + \text{N}_2$$

indicates that the heat of combustion of HA should liberate about 59.2 kcal/mol

The combustion vel of a decomposition flame of a 74% HA in nitric acid soln is 0.1 cm/sec. The flame is orange and ammonia is one of the flame products (Ref 8)

Stability. Some authors claim that NH_2OH decomposes merely on standing, but L. L. deBruyn (Ber 27, 967 (1894)) claimed that one sample decomposed only very slightly after a period of several years. In the opinion of Audrieth et al (Ref 6), some of the impurities cause catalytic decomposition and removal of these impurities improves the stability of product. On standing NH_2OH presumably decomposes, either as $3\text{NH}_2\text{OH} \rightarrow \text{NH}_3 + \text{N}_2 + 3\text{H}_2\text{O}$, or $4\text{NH}_2\text{OH} \rightarrow 2\text{NH}_3 + \text{N}_2\text{O} + 3\text{H}_2\text{O}$ depending on conditions (Ref 6)

Analytical. A number of analytical procedures for detecting and determining of NH_2OH are available (Ref 6). The best method is to add an excess of some oxidizing agent such as ferric ammonium sulfate to a soln of free base or one of its salts, and then determine the amt of oxidizing agent which has been reduced by standard permanganate or ceric sulfate solns

An alternate method consists of titrating aq NH_2OH with a std acid using a methyl orange indicator

Qualitatively, amounts as low as 1 part/100,000, may be detected by treating aq NH_2OH with ammonium CuSO_4 to get a red ppt of Cu_2O

Uses: Besides its uses as a reducing agent and in org synth, HA is claimed as an ingredient in several propellant formulations, in combination with AN & AP

Refs: 1) Gmelin, Syst 23, 569-602 & Mellor 8, 279-304 2) Schock & Pritchett, JACS 38, 2042 (1916) 3) Clark, OrgSynt, 3, 61-4 (1923) 4) S.B. Lippincott & H.B. Hass, IEC, 31, 118-20 (1939) & CA 33, 2104 (1939) 5) C.D. Hurd, Inorg Synth I, 87 (1939) 6) L.F. Audrieth et al, "Compounds of High Nitrogen Content," 1st Quart Rept, Univ of Illinois, Jan 1951 7) F.D. Rossini, NBSCirc 500, Washington, DC (1952) 8) N.W. Luft, Monatsh 94, 330 (1963) & CA 58, 13414 (1963) 9) R.A. Black & J. Betts, CanadJChem 43 (8) 2157 (1965) & CA 63, 9082 (1965) 10) Sax (1968) p 829

Hydroxylamine Salts & Complexes

Most strong acids form acid salts with HA. The following are fairly stable but some of them are explosive:

Hydroxylamine acid sulfate. $\text{NH}_2\text{OH}\cdot\text{H}_2\text{SO}_4$; mw 131.12, N 10.68%, white to brown crystals; v hygroscopic, mp indefinite, bp decomp; sol w, MeOH; sl sol EtOH. Toxic and may explode on heating. It is used as a reducing agent, photog developer & in synth of dyes, pharmaceuticals & rubber chems

Ref: CondChemDict, 8th Edit (1971), p 460

Hydroxylamine hydrochloride. $\text{NH}_2\text{OH}\cdot\text{HCl}$; mw 69.50, N 20.16%; colorl, hydr crystals (monoclinic), mp 152°, bp decomp, d 1.67; sol w, alc, glyc; insol eth. It is irritant. It is toxic (causes prolonged methemoglobinemia [Ref 3]) and it may react violently when heated. It is used in org synths, in photography & in medicine (Ref 3)

Prepd by hydrolyzing MeNO_2 with HCl (Ref 1); from aceto-oxime, water & Me_2CO with product crystallized at 20° (Ref 2)

Refs: 1) G. Bourjoul, MP 34, 63 (1952) & CA 46, 9236 (1955) 2) F. Mikula et al, Chem Prum (Czech) 17 (8) 415 (1967) & CA 67, 92406 (1967) 3) K.A. Arnol'dova & N.N. Speanski, Gigiena Truda 7 (12) 38 (1963) & CA 60, 16358 (1964) 4) CondChemDict, 8th Edit (1971), p 460

Hydroxylamine nitrate. $\text{NH}_2\text{OH}\cdot\text{HNO}_3$; mw 96.05, N 29.17%; white crystals, mp 48°, bp decomp at about 100°. Sol cold w, alc; decomp in 70° water. Prepd by reacting $\text{NH}_2\text{OH}\cdot\text{HCl}$ with AgNO_3 or $(\text{NH}_2\text{OH})_2\text{H}_2\text{SO}_4$ with $\text{Ba}(\text{NO}_3)_2$ (Ref 1). It is claimed as a propell ingred in combination with AN, AP & a curable liq binder (Ref 2)

Refs: 1) Mellor 8 (1928)p 303 2) H. Fox, USP 2970898 (1961) & CA 55, 1285 (1961) 3) Sax (1968) p 830

Hydroxylamine Perchlorate (HAP).

$\text{NH}_2\text{OH}\cdot\text{HClO}_4$, mw 133.50, N 10.50%; hydr crystals, mp 87.5-90°, decomp 120°, sol eth. ΔH_f° -66.2 kcal/mole (Ref 3). Prepd by reacting $\text{NH}_2\text{OH}\cdot\text{HCl}$ or $(\text{NH}_2\text{OH})_2\cdot\text{H}_2\text{SO}_4$ with BaClO_4 . Used to increase burning rate in propellants. Impact sens 15cm with 2 kg falling wt

A solid propell formulation based on HAP has been patented (Ref 2). It contains about 80% HAP (or $\text{LiClO}_4\cdot 2\text{NH}_2\text{OH}$ or $\text{MgClO}_4\cdot 4\text{NH}_2\text{OH}$) and 20% epoxy binder

The self deflagration of HAP & hydrazine nitroform was studied (Ref 4). It was found that HAP exhibits a low pressure deflagration limit of 146 atm analogous to the 20 atm limit of AP. Combust temps were determined

Refs: 1) J. H. Robinson, USP 2,768,874 (1956) & CA 51, 3146 (1957) 2) J. P. Flynn & E. J. Strayer, USP 3,305,413 (1967) & CA 66, 97092 (1968) 3) M. F. Zimmer et al, JChemEngData 13 (2) 212 (1968) & CA 69, 22651 (1968) 4) E. T. McHale & G. Von Elbe, Combust Sci Techn 2 (4) 227 (1971) & CA 74, 66209 (1971)

Hydroxylamine sulfate. $(\text{NH}_2\text{OH})_2\text{H}_2\text{SO}_4$, mw 164.14, N 17.07%; colorl monoclinic crystals, mp 177°, bp decomp. Sol w, eth, sl sol alc (Ref 2). Prepd by hydrolysis of MeNO_2 with H_2SO_4 . This reaction yields HA in an anhydrous medium: $\text{CH}_3\text{NO}_2 + \text{H}_2\text{SO}_4 = \text{HOSO}_2\text{CCH}\cdot\text{NOH}(1)$ $(1) + 2\text{H}_2\text{O} = \text{H}_2\text{SO}_4 + \text{HCOOH} + \text{NH}_2\text{OH}$ or $\text{H}_2\text{SO}_4 + \text{CO} + \text{NH}_2\text{OH}$ (Ref 1). Hydroxylamine sulfate is highly toxic. Its uses are similar to those for the acid sulfate

Refs: 1) G. Bourjoul, MP 34, 63 (1952) & CA 46, 9236 (1953) 2) CondChemDict (1971), 1971) p 460-L

Hydroxylamine complexes of some inorganic salts. The prepn & characterization of some NH_2OH complexes of various inorg salts are described. $(\text{NH}_3\text{OH})\text{ClO}_4$ forms complexes with both 1 and 2 moles of NH_2OH (see HAP) while the nitrate forms only a single complex. These complexes are, in general, less hygroscopic than the salt itself

Ref: R. H. Quacchia et al, IndEngChem, Prod Res Develop, 8 (2), 197 (1969) & CA 71, 35585 (1969)

Hydroxylamine Derivatives. Many NH_2OH derivatives may be obtained by substituting for the NH_2 or OH hydrogens. Replacement of the NH_2 hydrogens gives *hydroxylamines*, and *N-hydroxylamines* (also called β -hydroxylamines) of various degrees of substitution. Replacement of the OH hydrogens gives *o-hydroxylamines* (also called α -hydroxylamines) and *hydroxylamine-acids*. Inorganic and organic derivatives produced by both types of hydrogen replacement are listed below:

NH_2 Hydrogen Substitution

Calcium Hydroxylamate. $\text{Ca}(\text{NHOH})_2$, mw 104.13, N 26.90%. HA reacts with Ca at 5° to form a very explosive salt

Ref: E. Ebler & E. Schott, JPraktChem **78**, 289 (1908) & CA **3**, 754 (1909)

Sodium Hydroxylamate. NaNHOH , mw 54.0, N 26.0%. When an ether soln of NH_2OH is treated with metallic Na an extremely unstable explosive compd is formed

Ref: L. F. Audrieth et al "Compounds of High Nitrogen Content," 1st Quart Rept, U of Illinois, Jan 1951

Zinc Hydroxylamate. HA reacts with Zn at 5° to give an explosive salt of indeterminate composition

Ref: E. Ebler & E. Schott, JPraktChem **78**, 289 (no year) & CA **3**, 754 (1908)

Many *N-hydroxylamine* derivatives are known. They appear to be non-explosive, stable compounds eg CH_3HNOH (Ref 1) or $\text{HOOCCH}_2\text{-NHOH}$ (Ref 2)

Refs: 1) Beil **4**, 534, [1952] & {1715} 2) Beil **4**, 542

However some of *N-hydroxylamino-alkanoic acids* form nitroso compounds and some of the metal salts of such compounds are explosive as shown below:

Hydroxylaminoacetic Acid or 2-(Hydroxylamino)-ethanoic Acid. (Hydroxylaminoessigsäure or Hydroxylaminoäthansäure in Ger), $\text{HO.NH.CH}_2\text{.COOH}$ is described in Beil **4**, 542. It is the parent compd of its nitroso deriv described below

Nitrosohydroxylaminoacetic Acid, Isonitraminoacetic Acid or 2-(Nitrosohydroxylamino)-ethanoic Acid. (Isonitraminoessigsäure in Ger), $\text{HO.N(NO).CH}_2\text{.COOH}$, mw 120.07, N 23.33%. Needles (from ether + ligroin), mp—decomp $103\text{-}4^\circ$; stable only in solns. Prepd by passing NO

thru an alc soln of ethylsoda-acetoacetate and then reacting the acid to form the lead salt

Its silver, calcium & ammonium salts are explosive

Refs: 1) Beil **4**, 575 2) W. Traube, Ber **28**, 1791-3 (1895) & JCS **68i**, 503 (1895)

2-(Hydroxylamino)-1-butanolic Acid or α -Hydroxylaminobutyric Acid. (2-Hydroxylamino-butansäure-(1) in Ger). $\text{HO.NH.CH(C}_2\text{H}_5\text{).COOH}$ is described in Beil **4**, 543. It may be considered as the parent compd of its nitroso-deriv described below

2-(Nitrosohydroxylamino)-1-butanolic Acid or α -Isonitraminobutyric Acid. (α -[Nitrosohydroxylamino]-buttersäure or α -Isonitraminobuttersäure in Ger). $\text{HO.N(NO).CH(C}_2\text{H}_5\text{).COOH}$, mw 148.12, N 18.91%. It is stable only in solns. May be prepd by passing NO gas through an alc soln of ethylic ethyl-acetoacetate to which some potassium ethylate was added, followed by saponification. Evaporation of this soln yielded a gummy substance which could not be crystallized (Refs 1 & 2)

Its lead salt, $\text{C}_4\text{H}_6\text{N}_2\text{O}_4\text{Pb}$, is explosive (Ref 2)

Refs: 1) Beil **4**, 576 2) W. Traube, Ber **28**, 1793 (1895) & JCS **68i**, 502 (1895)

2-(Hydroxylamino)-3-butanone-1-ic Acid, Ethylester or α -(Hydroxylamino)-ethylacetate. $\text{CH}_3\text{CO.CH(NH.OH).COOC}_2\text{H}_5$ is not found in Beil **4**, but its nitroso deriv (see below) is described

2-(Nitrosohydroxylamino)-3-butanone-1-ic Acid, Ethylester; α -(Nitrosohydroxylamino)-ethyl-acetoacetate or α -Isonitraminoacetoacetic Acid, Ethylester. {Ger names: Äthylester der 2-[Nitrosohydroxylamino]-butanon-(3)-säure, β -Oxo- α -[nitrosohydroxylamino]-propan- α -carbonsäure-äthylester, α -[Nitrosohydroxylamino]-acetessigsäure-äthylester or α -Isonitramino-acetessigsäure-äthylester} $\text{CH}_3\text{.CO.CH[N(NO).OH].COOC}_2\text{H}_5$ Its disodium salt, $\text{C}_6\text{H}_8\text{N}_2\text{O}_5\text{Na}_2\text{+H}_2\text{O}$ is explosive and was obtained when dry nitric oxide was passed into a 10 per cent alc soln of ethylic sodacetoacetate as described in Ref 2
Refs: 1) Beil **4**, 577 2) W. Traube, Ber **27**, 1507 (1894) & JCS **66i**, 400 (1894)

2-(Hydroxylamino)-1-propanoic Acid or α -Hydroxylaminopropionic Acid. $\text{HO.NH.CH(CH}_3\text{).COOH}$, is not found in Beil **4**, but its nitroso deriv (see below) is described

2-(Nitrosohydroxylamino)-1-propanoic Acid or α -Isonitraminopropionic Acid $\{\alpha$ -[Nitrosohydroxylamino]-propionsäure or α -Isonitramino-propionsäure $\}$ $\text{HO.N(NO).CH(CH}_3\text{).COOH}$; mw 134.09, N 20.89%. It is stable only in solns. May be prepd by warming with soda the crude soln obtained by the action of nitric oxide on ethylic methylacetoacetate, until the alcohol is driven off; the acid is then precipitated as the **Lead Salt**, $\text{PbC}_3\text{H}_4\text{N}_2\text{O}_4$, which is explosive *Refs:* 1) Beil 4, 576 2) W. Traube, Ber 28, 1793 (1895) & JCS 68, 503 (1895)

Aryl derivatives of N-hydroxylamine form azo and nitro compounds which are unstable towards heat but not explosive

Azo-Derivatives of N-phenylhydroxylamine
cryst comps of the type

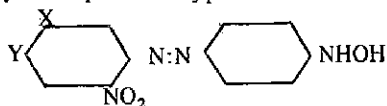

are known where X is Cl or OH, & Y is NO₂ or NO. They decomp in the range of 210-230°. The dinitro Cl deriv is prepd by reacting benzoquinone-1,4-monoxime with 5-chloro-2,4-dinitrophenylhydrazine, and 4,6-Dinitro-3-hydrazinophenol to get the OH compd. Similarly, the cyano deriv is prepd from the above oxime and 2-nitro-4-cyanophenylhydrazine
Ref: Beil 16, [260]

Nitro-Derivatives of Aryl-N-hydroxylamine

6-Nitro-2,4-Dihydroxylamino-phloroglucinol (called -phloroglucin in Ger). $(\text{HO})_3\text{C}_6(\text{NO}_2)(\text{NHOH})_2$; mw 233.14, N 18.03%, OB -58.5%; yellowish needles, mp 166° (decomp) has similar props and same meth of prep as the dinitro derivative described below

2,4,6-Trihydroxylaminophloroglucinol.

$(\text{OH})_3\text{C}_6(\text{NHOH})_3$; alum colorl needles (from eth); sol in eth & dil alk solns. Very unstable. Other props and method of prep same as above

4,6-Dinitro-2-hydroxylamino-phloroglucinol (called 4,6-Dinitro-2-hydroxylamino-phloroglucin in Ger). $(\text{HO})_3\text{C}_6(\text{NO}_2)_2(\text{NHOH})$; mw 247.12, N 17.01%, OB -42.3%; yel needles (from eth), mp 146-148° (decomp); readily sol in hot w, org solns & dil nimeral acids. Alc or eth soln

oxidizes readily in air. Formed (in addn to other products, see above) by heating, in air, 2,4,6,2',4',6'-Hexanitro 3,3'-dioxy-azobenzene in a concd KCO_3 soln; is converted to the *trinitrophenol* in boiling w
Ref: Beil 15 [27]

2,4,6-Trinitro-3-hydroxylaminotoluene, N-[2,4,6-Trinitro-3-methyl-phenyl] hydroxylamine. $\text{H}_3\text{CC}_6\text{H}(\text{NO}_2)_3(\text{NHOH})$; mw 258.15, N 21.71%, OB -62%; dark yellow crystals (from aq alc), mp 99° (decomp); sol in alkalis or aq ammonia. Prepd by heating 2,4,6-Trinitro-3-methoxytoluene with an alc soln of hydroxylamine. With concd nitric acid it forms 2,3,4,6-tetranitrotoluene

The 4,6-dinitro derivative has also been prepared
Ref: Beil 15 [15]

OH Hydrogen Substitution

Hydroxylamine-o-Sulfonic acid, $\text{NH}_2\text{OSO}_3\text{H}$; mw 113.10, N 12.40%; white, hygr, microcrystalline solid, decomp 210°. Stable if stored in moisture-free atmos. Prepd by: the room temp reaction of $(\text{NH}_2\text{OH})\cdot\text{H}_2\text{SO}_4 + 2\text{H}_2\text{SO}_4\cdot\text{SO}_3 = 2\text{NH}_2\text{OSO}_3\text{H} + 3\text{H}_2\text{SO}_4$; by reacting a hydroxylamine salt with an excess of chlorosulfonic acid; by bubbling HN_3 thru fuming H_2SO_4 at 60-80°

$\text{NH}_2\text{OSO}_3\text{H}$ reacts with ammonia and amines to give, respectively, hydrazine and substd hydrazines

Ref: H.J. Matsuguma & L. F. Audrieth, InorgSynth 5, 122 (1957)

o-Methylhydroxylamine, α -Methylhydroxylamine, Methoxylamine. CH_3ONH_2 ; mw 47.06, N 29.77%, OB -153%; fluid liq, bp 49-50°; sol in w, alc & eth. Prepd by reaction of $\text{C}_6\text{H}_5\text{C}(\text{OC}_2\text{H}_5)$: NOCH_3 & HCl ; by heating the di-K salt of o-methylhydroxylamine-N,N-disulfonic acid in dilute acid soln. Explodes at 300°. Atomic constants and IR spectra have been measured (Ref 1)

It can be stabilized against explosion by shock (adiabatic compression by a piston) by adding 75 parts by weight of either EtOH, MeOH, N_2H_4 or MeNH_2 (Ref 2)
Refs: 1) Beil 1, 288 (143) [275] & {1212} 2) S.A. Greene, USP 3117415 (1964) & CA 60, 9093 (1964)

Written by J. ROTH

Hydroxymethyl alkanes. Compounds such as $\text{CH}_3 \cdot \text{C}(\text{CH}_2\text{OH})_3$ or $\text{C}_2\text{H}_5\text{C}(\text{CH}_2\text{OH})_3$, called also "polymethylolalkanes." See under "Polyhydroxy Compounds"

Hydroxymethylbenzoic Acid.

5-Hydroxy, 2,4,6-Trinitro-3-methylbenzoic acid (also called 5-Oxy-2,4,6-trinitro-m-toluic acid). $\text{HO}C_6(\text{NO}_2)_3(\text{CH}_3)\text{COOH}$; mw 287.16, N 16.64%, OB to CO_2 -52.9%; crystals containing 1 mole H_2O , starts to melt (with decomp) between 170° & 180° , puffs off above 180° . Prepd by heating 5-hydroxy-3-methyl benzoic acid with 1.38 g/cc nitric acid
Ref: Beil 10, 227 & (98)

2,2-Bishydroxymethylbutanol (1) trinitrate. $\text{C}_2\text{H}_5\text{C}(\text{CH}_2\text{ONO}_2)_3$; mw 269.17, N 15.61%, OB to CO_2 -50.5%; crystals (from acetone), mp 51.2° . Prepd by mixed acid nitration of 2,2-Bishydroxymethylbutanol (1). It was used in explosive compositions by the Dupont Co
Ref: Beil 1, {2350} 2) Not found in CA 1957-1971

N-Hydroxymethylethylenedinitramine or N-[(Hydroxymethyl)-N,N'-dinitro] ethylenediamine. $\text{O}_2\text{N} \cdot \text{HN} \cdot \text{CH}_2 \cdot \text{CH}_2 \cdot \text{N}(\text{NO}_2)\text{CH}_2\text{OH}$; mw 196.13, N 31.1%, OB -40.7%; prisms, mp $127-130^\circ$ (decomp on prolonged heating in water bath)

May be prepd by adding 40% formaldehyde to ethylenedinitramine in boiling water
Ref: F. Chapman et al, JCS 1949, 1635-36 & CA 44, 1411 (1950)

Hydroxymethylhydroperoxide, Methylolhydroperoxide or Methylhydroperoxide. (Called Oxymethylperoxyd or Mono-oxymethylperoxyd- in Ger). HOCH_2OOH ; mw 64.01; Oil of medium consistency; fairly stable in storage; RI 1.4205 at 16° . May be prepd by treating anhydrous formaldehyde in dry ether with anhydrous H_2O_2 ;

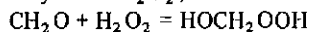

Easily sol in w, alc, eth, acetone & dioxane; sl sol in chl f & petroleum ether; insol in benz

It is an explosive which is not sensitive to friction but explodes with extreme violence when heated in a flame. Its higher homologs are not explosive (Ref 4)

Its IR absorption spectrum has been studied (Ref 5)

Refs: 1) Beil not found 2) A. Rieche & R. Meister, Ber 68, 1468-1473 (1935) & CA 29, 6877 (1935) 3) F. Walker, "Formaldehyde," Reinhold, NY (1944), p 127 4) See Table in article on Hydroperoxides in this Vol 5) A.V. Karyakin & V.A. Nikitin, IzvestAkadNauk, SSSR, Ser Fiz 17, 636 (1953) & CA 48, 5652 (1954)

Hydroxymethylnitramines. See under Hydroxy- and Amino-methyl-nitramines

3-Hydroxy-6-nitro-2-phenylindazole.

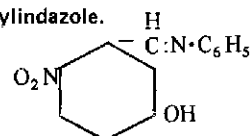

mw 242.23, N 11.57%; crystals, mp $> 260^\circ$. Prepd by refluxing 2,4-Dinitrobenzylidene aniline, $(\text{O}_2\text{N})_2\text{C}_6\text{H}_3\text{CH:NPh}$, with Na-carbonate in EtOH and then treating with HAc. The Na salt of this product explodes on heating

Ref: S. Secareanu & I. Lupas, Bull soc chim (5) 1, 373 (1934) & CA 28, 5445 (1934)

1-Hydroxy-2-propanone. See Acetol in Vol 1 of Encycl, p A33-R

Hydroxypropylamine and N-(2-Nitroxypropyl)-nitramine, designated as **Iso-Me-NENA**, are described under Aminopropanols and Derivatives in Vol 1, p A253

α -Hydroxypropylethylperoxide (α -Oxypropyl- α thyl-peroxyd- in Ger). $\text{C}_2\text{H}_5\text{CH}(\text{OH})\text{OOC}_2\text{H}_5$; mw 120.15, OB -173%; non-viscous oil; d 0.974 at 21° ; bp $50-52^\circ$ at 50mm; RI 1.4021 at 21.4° . May be prepd by treating propionic aldehyde with ethylhydroperoxide, $\text{C}_2\text{H}_5\text{OOH}$. Explodes on heating
Refs: 1) Beil, not found 2) A. Rieche & F. Hitz, Ber 63, 2648 (1930); CA ref not found

Hydroxypropyl-3-oxy-1,2-propanedioltrinitrate. See under Hydroxyethyl-3-oxy-1,2-propanedioltrinitrate in this Vol

2-Hydroxypyridine, 3,5-Dinitro (Called 3,5-Dinitro-oxy-pyridin in Ger).

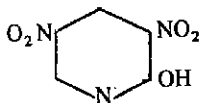

mw 185.10, N 22.70%, OB -56.2%; yellow ndls (from eth), mp 133°, sol in benz, alc or warm watter. Prepd by mixed acid nitration of 2-hydroxy-pyridine. Explodes weakly on heating above mp. Its alkali-salts are very explosive

The 3,5 Dinitro-4-hydroxy-pyridine, mp 325°, on the other hand, or its alkali salts are not explosive

Ref: Beil 21, 48 & [33 & 35]

Hydroxypyruvic Acid (Oxypyruvic Acid).

$C_3H_4O_4$; mw 104.06. One of the products of the alkaline saponification of NC and nitro-oxy-cellulose (Ref 1). Berl and Smith (Ref 3) obtained it, calling it oxypyruvic acid, by the alkaline hydrolysis, not only of NC, but also of nitrates of glucose and levulose

This substance may be present as an impurity in commercial NC

Refs: 1) W. Will, Ber, 24, 400 & 3831 (1891)
2) Marshall, I, (1917), 192 3) E. Berl & W. Smith, JSCI, 27, 534 (1908)

HYDROXYQUINOLINE and DERIVATIVES

Many hydroxyquinoline isomers are known. Only the 2-hydroxy or 8-hydroxy quinolines appear to have nitro derivatives that are near explosive

2-Hydroxyquinoline or Quinolone (Called 2-Oxy-chinolin in Ger).

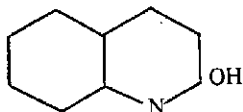

mw 145.15, N 9.65%; prisms (from alc), mp 199–200°, v sl sol in w; sol in alc. Prepd by heating 2-Acetaminobenzaldehyde with NaOH in aq alcohol

Ref: Beil 21, 77

4-Hydroxyquinoline (Called 4-Oxy-chinolin in Ger).

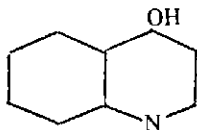

mw 145.15, N 9.65%; monoclinic ndls, mp 201°, difficult to sublime; sol in warm water & alc; sl sol in eth or benz. Prepd by heating 2-formaminoacetophenone in aq NaOH
Ref: Beil 21, 83

8-Hydroxyquinoline or 8-Quinololinol, oxyquinoline or Oxine (Called 8-Oxy-chinolin or Chinophenol in Ger).

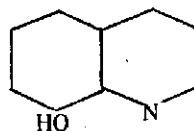

mw 145.15, N 9.65%; prisms (from alc), mp 75–76°, bp 267°, sublimes readily. Prepd by heating acidified 2-Amino-phenol with 2-Nitrophenol, glycerin & concd sulfuric acid

Ref: Beil 21, 91

The mononitro derivatives of the 2-hydroxy & 8-hydroxy quinolines are stable (Beil 21, 99–100). The di & tri-nitro derivatives are less stable but not really explosive. These are described below

5,7 Dinitro-2-hydroxyquinoline.

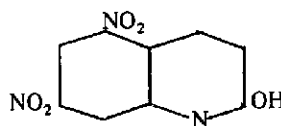

mw 235.15, N 17.87%, OB -104.2%; golden-yel leaflets, mp 267° (with decomposition); insol in most solvents. Prepd by nitrating 2-hydroxy-quinoline with conc nitric acid
Ref: Beil 21, 100, (220) & [58]

3,6-Dinitro-4-hydroxyquinoline.

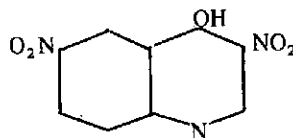

mw 235.15, N 17.87%, OB -104.2%; mp 352–4° (decomp). Prepd by mixed acid nitration of 4-hydroxyquinoline

Refs: 1) J.C.E. Simpson & P.H. Wright, JChem Soc 1948, 2023 & CA 43, 3002 (1949) 2) S.P. Findlay & L.F. Small, JACS 72, 3247 (1950) & CA 44, 10722 (1950)

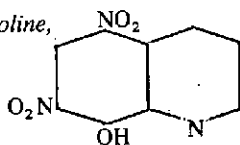
5,7-Dinitro-8-hydroxyquinoline,

mw 235.15, N 17.87%, OB -104.2%; yellow crystals (from alc), mp 276° (Ref 1); mp 276-79° (from ethyleneglycol) with decomposition (Ref 3), mp 320° (decomp) (Ref 2). Prepd by concd nitric acid nitration of 8-hydroxyquinoline
Refs: 1) J.W. Airan & D.S. Wagle, *JUnivBombay* **23**, Part 3, Sec A (36), 29 (1954) & *CA* **49**, 10273 (1955) 2) S. Carboni, *GazzChimItal* **85**, 1194 (1955) & *CA* **50**, 9403 (1956) 3) T. Nogradi et al, *ActaChimAcadSciHung* **6**, 287 (1955) & *CA* **51**, 5078 (1957)

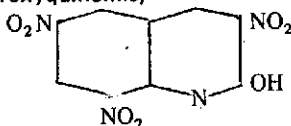
3,5,8 Trinitro-2-hydroxyquinoline,

mw 280.15, N 20.00%, OB -76.8%; bright yellow needles (from xylene), mp 182° (decomp). Prepd by concd nitric acid nitration of 2-hydroxyquinoline
Ref: Beil **21**, (220)

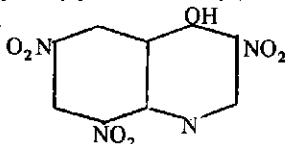
3,6,8 Trinitro-4-hydroxyquinoline or 3,6,8-Trinitro-4-quinolinol.

mw 280.15, N 20.00%, OB -76.8%; yel prisms, mp 296° with decomposition. Prepd by mixed acid nitration of 3-nitro-4-hydroxyquinoline (Ref 1); or reaction of AcONO₂ with quinoline N-oxide in Ac₂O (Ref 2)
Refs: 1) G. Bendz et al, *JChemSoc* **1950**, 1130 & *CA* **44**, 1072 (1950) 2) E. Ochiai & C. Kaneko, *PharmBull (Tokyo)* **5**, 56 (1957) & *CA* **52**, 1165 (1958)

Hydroxyquinone Diazides, Dinitro Derivatives of.

Percussion caps or detonators are loaded with one or more of the ortho- or para-nitrated quinone diazides of the polymeric phenols or their metallic salts. The K salt of dinitro-m-hydroxyquinone diazide is obtained from nitraminoresorcinol by treatment of the hot

strong H₂SO₄ & HNO₃ soln with excess of KNO₃ & long boiling. On cooling, the salt crystallizes out in fine yellow needles. Dinitro-3,5-dihydroxyquinone diazide is prepd in the same way from mono- or di-nitroaminophloroglucinol

Ref: E. von Herz, *BritP* 207563 (1922) & *CA* **18**, 1573 (1924)

m-Hydroxytetryl. Same as 2,4,6-Trinitro-3-methylnitraminophenol described under.

Methylaminophenol and Derivatives

o-Hydroxytoluene. See Benzyl Alcohol in Vol 2 of Encycl, p B91-L

2-Hydroxytoluene. See o-Cresol in Vol 3 of Encycl, p C556-L

3-Hydroxytoluene. See m-Cresol in Vol 3 of Encycl, p C556-L

4-Hydroxytoluene. See p-Cresol in Vol 3 of Encycl, p C556-L

Hydroxy-tetrazole. See Tetrazolol and Derivatives. These include:

- 1-Hydroxytetrazole*
- 1-Hydroxy-5-azidotetrazole*
- 5-Hydroxytetrazole*
- Hydroxytetrazolylmethanol*
- Hydroxytetrazolylmethanol Nitrate*

Hydroxy-triazole Derivatives. See Triazole Derivatives. These include:

- 3-Hydroxy-*asym*-triazole*
- Hydroxybenzotriazole, Chloro Derivatives*
- 1-Hydroxy-4-benzoyl-5-methyl-*sym*-triazole*
- 1-Hydroxy-4,5-dicarboxylic acid-*sym*-triazole*
- [2'-Hydroxynaphthyl]-1'-azo-3-[5-azido-*asym*-triazole]*
- 4-Hydroxymethyl-5-hydroxy-*sym*-benzotriazole*
- 5-Hydroxy-1-(*p*-nitrophenyl)-3-carbonyl azido-*asym*-triazole*
- 1-Hydroxy-5-phenyl-tetrazole*
- 1-Hydroxy-*sym*-triazolopyrimidine*

Hygiene-Industrial, in War Plants. The reader is referred to the following lectures & reviews:

"Industrial Hygiene at work in the national defense program" (Ref 1); "Mobilization of

Industrial hygiene for national defense" (Ref 2); "Industrial hygiene at work in defense industries" (Ref 3); "Industrial hygiene support in a missile program" (Ref 4)

Refs: 1) A lecture by J.J. Bloomfield, *Ann Intern Med Phys* **15**, 165 (1941) & *CA* **36**, 5915 (1942) (no summary) 2) Lecture by W.J. McConnell, *JAmPubl Health* **32**, 9 (1942) & *CA* **36**, 1693 (1942) (no summary) 3) W.A. Cook, *Metal Finishing* **40**, 19 (1942) & *CA* **36**, 2039 (1942) (no summary) 4) A review by C.B. Truman, *Ann Ind Hyg Assoc J* **25** (6), 607 (1964) & *CA* **63**, 8952 (1965)

Hygrometric Tests: Tests designed to determine hygroscopicity (see under Hygroscopicity Tests)

Hygroscopicity. Hygroscopicity is the property possessed by some substances of readily absorbing atmospheric moisture. Some explosives, as well as substances serving as ingredients of explosive mixtures, are *hygroscopic*. Most nitrated organic compounds per se are only slightly hygroscopic, but the materials added as oxidizers, such as NaNO_3 , NH_4NO_3 etc, or as explosion temperatures suppressors, such as NaCl etc, are very hygroscopic

Hygroscopicity is a property which is very undesirable in explosives, because moisture lowers their power, brisance and sensitivity. Moisture also lowers the ballistic potential of propellants. For this reason, it is advisable to keep explosive mixtures as non-hygroscopic as possible. This may be done either by excluding hygroscopic ingredients or by coating these ingredients with substances such as vaselin, paraffin, wax, oils, rosin etc. Nitrocellulose is made non-hygroscopic by gelatinization with solvents. Hygroscopic dynamites are protected from atmospheric moisture by enclosing them in paraffin coated paper cartridges

Hygroscopicity Tests. Hygroscopicity is the affinity of a substance for water vapor. It is a complex phenomenon which is controlled by the rate of diffusion of water across the vapor-liquid interface. This rate depends on temperature, surface area, liquid depth, and liquid and vapor film coefficients. Inasmuch as it is impractical to measure the effect of all these variables, simplified empirical tests have been

designed to determine the relative hygroscopicity of various substances

Some of these tests applicable to explosives and propellants are as follows:

1) *Desiccator test.*

a) Using an analytical balance, weigh a large flat weighing dish provided with a glass stopper (W_1)

b) Weigh separately in a scoop, on a rough balance, 5-10g of a test sample (of known moisture content) and introduce it into the weighing dish. Stopper and reweigh (W_2)

c) Remove the stopper and place the dish in a desiccator containing a saturated solution of potassium nitrate containing a few crystals

d) After leaving it in the desiccator for 24 or 48 hours, reweigh the dish (W_3)

$$\% \text{ Moisture absorbed} = \frac{W_3 - W_2}{W_2 - W_1} \times 100$$

Note: Instead of using the potassium nitrate solution, Wilson (Ref 1) recommends the use of aqueous solutions of sulfuric acid. The following table gives the strength of H_2SO_4 required to give different relative humidities (RH) at various temperatures

%RH	% Sulfuric Acid Required			
	0°	25°	50°	75° C
10	63.1	64.8	66.6	68.3
25	54.3	55.9	57.5	59.0
35	49.4	50.9	52.5	54.0
50	42.1	43.4	44.8	46.2
65	34.8	36.0	37.1	38.3
75	29.4	30.4	31.4	32.5
90	17.8	18.5	19.2	20.0

A chart giving a detailed relation between relative vapor pressures, $\% \text{H}_2\text{SO}_4$ and density of solutions is given on p 328 of Ref 1

2) *British Hygroscopicity Test for Black Powder.*

Put about 65g of powder (of known moisture content) into a tared small tray with a bottom of fine gauze and reweigh. Place it inside a box over a tray containing a saturated solution of KNO_3 . Allow it to remain there either 24 hours for small grain powders, or for 48 hours for large grain powders. Reweigh the tray and determine the percentage of weight gain. Add to this the percentage of moisture originally present to obtain the hygroscopicity of the powder (Ref 2)

3) *Hygroscopicity Test at 15° in a moisture-saturated atmosphere.* A sample of 10-100g of dried material is placed in a constant temperature room at 15° saturated with moisture. The sample is reweighed periodically until constant weight is attained (Ref 4)

4) *US Armed Forces Test at 30° and 90% RH*

a) Transfer a sample of about 100g to a tared (W_1) wide glass weighing dish with a ground glass cover. Weigh tare & sample on an analytical balance (W_2)

b) Remove the cover and place the dish in a humidor containing 1 liter of a sulfuric-water mixture ($18.6 \pm 0.5\% \text{ H}_2\text{SO}_4$), which will maintain a relative humidity of $90 \pm 0.25\%$ at 30°. The humidor shall have a total capacity of about 10 liters and should be capable of being sealed hermetically

c) Place the humidor in an oven maintained at $30 \pm 2^\circ$ and leave it there for 3 days

d) On the fourth day, remove the dish, stopper it and weigh (W_3)

e) Repeat the weighings every day thereafter until the sample ceases to gain weight, indicating that the powder has reached equilibrium with 90% RH (W_n)

$$\% \text{ Gain} = \frac{W_n - W_2}{W_2 - W_1} \times 100 = \%G, \text{ where}$$

$W_2 - W_1$ is usually 100g

This figure has to be added to the total moisture content (%M) as determined on another sample of 100-200g and the sum gives the % hygroscopicity (%H) = %G + %M (Ref 3)

Total moisture content is determined on a separate 100 to 200g sample by distilling it in a 500ml flask with 200ml of dry CCl_4

5) *Humidity Equilibrium Method* (Ref 1)

a) Set up an apparatus consisting of 3 large bubbler bottles, containing aqueous solutions of H_2SO_4 of the desired humidity at the temperature of the test connected to a wide tube containing glass wool or cotton and to a tared (W_1) straight or U-tube containing 20-60g of loose powder without any cotton or glass wool. The weight of the tube with the sample is designated as W_2 and both weighings should be done on an analytical balance

b) Pass a slow current of compressed air (50 to 500cc per min, using the higher rates at lower temperatures) through the bubbler bottles and then through the glass wool tube into the

tube containing the sample

c) Weigh the tube containing the sample every few hours until constant weight is reached (W_3)

d) Disconnect the tube with the sample and pass a stream of warm air (50 to 125°) through it. This air stream is predried by passing it thru a U-tube containing P_2O_5 , until constant weight in the sample tube is reached (W_4)

The % "equilibrium moisture content" of the sample at the temperature and humidity of the test, and calculated on the dry weight of the sample is equal to: $\frac{W_3 - W_4}{W_4 - W_1}$ where (W_1) is

$$W_4 - W_1$$

the weight of the empty tube, (W_3) the weight of the tube plus humid sample and (W_4) the weight of tube plus dry sample

In order to make certain that equilibrium has been reached in any given case, it is always desirable to approach it from both the dry and the moist sides. The simplest and quickest way to accomplish this with a single sample is to pass dry air through the sample at the start and then determine the equilibrium weights at 10, 25, 50, 75 and 90% humidity. After this, saturated air (100% humidity, obtained by bubbling air through water) is passed for a short time thru the sample and the same points redetermined in the reverse order. Finally, dry hot air is passed thru in order to obtain the dry weight

Alternate means of controlling humidity by using saturated solutions of salts have been proposed (Ref 7). For instance; at 30° a saturated solution of KNO_3 gives about 92% RH; $\text{KCl} = 84.5\%$; $\text{NaCl} = 75.5\%$; $\text{Ca}(\text{NO}_3)_2 \cdot 4\text{H}_2\text{O} =$ about 50% etc

6) *French test (LeRoux)*

Fifty grams of a previously dried explosive sample is placed in a closed container above 21° Be sulfuric acid. The % moisture pick-up of the explosive is determined daily and plotted on a chart (Ref 9)

In addition to the general tests listed above a number of studies & tests for specific ingredients have been published. These data for *propellants*, *NC* and for *ammonium nitrate (AN)* are summarized below:

The hygroscopicity of a *propellant* is determined rapidly in an apparatus consisting of 2 identical gas washing bottles provided with fritted glass plates near the bottom. The outlets at the bottom are connected through a diaphragm pump

having a capacity of 400 l/hr. The top outlets are connected to complete the path for air circulation. In one flask is placed 50g of the propellant in the form of shavings 0.1mm thick. In the other is a soln of CaCl_2 of such concn that the vapor pressure of water over it at 20° is 0.75 of that of pure water. The entire apparatus is immersed in a thermostat at 20° . The moist air is circulated until equil is attained, which requires $\sim 1\frac{1}{2}$ hrs, as measured by increase in wt of the sample. The method may be used for materials other than propellants (Ref 15)

Various attempts have been made to relate the *hygroscopicity* of NC to its nitrogen content. For uncolloided NC at 30 to 70% RH the % moisture $\approx 14.6\%N$. Thus for "pyrocotton" (12.6%N) calc % moist = obs moist = 2% & for guncotton calc moist = 1.2 \approx obs moist = 1.3% (Ref 6). For colloided NC the above formula has been modified to % moist = $14.6\%N - 0.4$, but the calc moistures based on this modification do not always agree with experiment (Ref 6)

The linear (inverse) relation between NC moisture content and NC nitrogen content was also noted in Ref 5

Urbański (Ref 12) gives the moisture contents of 13%N & 12.5%N as 1 to 1.5% & 1.5 to 2% respectively

Tavernier (Ref 10) discusses the effects of hygroscopicity (and several other factors) on the ballistic props of colloided double base propellants and incompletely gelatinized oxidizer-containing propellants. The studies of Ficherouille & Kovache (Ref 8) on effects of hygroscopicity (and several other factors) on the potential usefulness of substances as priming explosives should also be mentioned, although NC is not one of the substances examined

Because of its importance in commercial explosives, and because it is highly hygroscopic, the hygroscopicity of AN has been studied intensively:

Equilibrium moistures (hygroscopic points) in AN determined by static or flow methods do not agree. In general, flow methods are recommended. To increase the rate of moisture exchange (at a given RH) the temp of system should be raised (Ref 11)

The hygroscopicity of AN can be decreased by the addition of calcium carbonate. The reduction in hygroscopicity is proportional to

the calcium carbonate content if the latter is similar in grain size to the AN. Kaolin can be used almost as effectively as calcium carbonate (Ref 14)

AN starts to pick up moisture at 55% RH. With the addition of 1.12% P_2O_5 or 1.73% $\text{Ca}(\text{NO}_3)_2$ these humidities decrease to 45 & 33% RH respectively. AN begins to dissolve at 63-67% RH (Ref 13)

Effect of surface-active agents & mineral additions on the *hygroscopic* nature & caking tendency of ammonium nitrate was examined in the following lab experiments in order to improve the storage properties of AN: (a) AN was crystd from satd solns contg 0-1.0% of cationic, anionic or nonionic surfactants; (b) granules of AN (0.5-1.0mm) were contacted with a satd NH_4NO_3 soln contg varying amts of surfactants; (c) granules of NH_4NO_3 were wetted by mineral oil, excess of oil removed, & the granules coated with talc or clay. The effect of the concn of several surfactants on caking tendency & hygroscopicity, under varying pressures & relative humidity, was detd & the results related to those obtained with untreated AN. According to process (a), caking tendency decreased 2.5 fold & hygroscopicity decreased 2.0 fold; according to (b), these decreases were 4 & 5 times respectively when 0.1% of Dispergator NF or 0.2% of carboxymethylcellulose was used; and according to (c) these decreases were 4 & 1.5 times respectively (Ref 17)

To extend the shelf life of explosives contg NH_4NO_3 , it is important to minimize its hygroscopicity. Samples were tested for hygroscopicity at relative humidity levels of 60, 70, 80 & 90% & between $28-30^\circ$. Most of the samples were coated; some were manufd by a process producing prills; clay material was added in 2 cases. The results indicated that the NH_4NO_3 which contained the least amt of impurities or additive was also the least hygroscopic (Ref 18)

Laboratory investigations of Igdanit (ammonium nitrate-fuel-oil explosives). Flaked & prilled Igdanit, differing in particle-size distribution, d, & amt & kind of coating agent or additive were obtained from 8 sources. *Hygroscopicities*, relative rates of drying & ease of fracture of the dried particles after wetting were detd (Ref 16)

Refs: 1) R.E. Wilson, IEC 13, 326 (1921) 2) Marshall 2, 417 3) US Spec JAN-P-270, p 4 4) H. Kast & L. Metz, Chemische Untersuchung der Spreng- und Zündstoffe, Braunschweig (1931), p 274 5) P. dePauw, SS 34, 69 (1939) & CA 33, 4424 (1939) 6) Ordn Proof Manual 7-26 (1945) p 28 7) F.E. O'Brien, "The Control of Humidity by Saturated Salt Solutions," JSci Instruments 73-76 (1948) 8) H. Ficherouille & A. Kovache, MP 31, 7 (1949) & CA 46, 11686 (1952) 9) A. LeRoux, MP 32, 129 (1950) 10) P. Tavernier, MP 36, 231 (1954) & CA 50, 2979 (1956) 11) V.V. Boldyrev et al, Trudy Tomsk Gosudarst Univ, Ser Khim 145, 155 (1954) & CA 54, 9463 (1960) 12) T. Urbański, Chemia i Technologia Materialów Wybuchowych, Warsaw, (1955), v 3, p 361 13) N.I. Krylova et al, Izvest Akad Nauk Uzbek SSR No 10, 29 (1955) & CA 53, 2547 (1959) 14) K. Kuleliev & D. Shishkov, Khim i Ind (Sofia) 29 (1), 16 (1957) & CA 52, 15849 (1958) 15) M. Parpaillon, MP 40, 247 (1958) & CA 55, 18112 (1961) 16) B.D. Rossi & V.A. Usachev, Vzroyvchatye Veshchestra Prosteishego Sostara, Inst Gorn Dela, Akad Nauk SSSR, Sb Statei i Materialov, 20, (1960) & CA 57, 2484 (1962) 17) V.L. Maksimov et al, Tr Mosk Khim Technol Inst, 54, 96 (1967) & CA 68, 31620 (1968) 18) J. Harris (Picatinny), US Clearinghouse Fed Sci Tech Inform, AD 1970, No 869315 & CA 75, 65761 (1971)

Hypercompression of Explosives. See Vol 3, p D20-R under Dead-Pressed Explosives

Hypergolic Propellants. Hypergolic propellant systems are those which ignite spontaneously on mixing. Those which do not are called non-hypergolic. Of course, the real difference between hypergolic and non-hypergolic systems lies in the rates of chemical reactions at the mixing temperatures. Hypergolic propellants react quickly enough at ambient temperatures to liberate heat so that they therefore ignite spontaneously. Ignition delay measurements normally are indicative of rates of reaction and so much work has been done in this area

Ignition Delay. Ignition delays in the range of 39-80 msec were measured by the impingement method for 80% H_2O_2 and mixts of N_2H_4 , CH_3OH and H_2O . Delay varied with

impingement angle, mixture ratio and temp (Ref 1). For combinations of HNO_3 with aniline, furfuryl alc, and mixts of aniline and furfuryl alc, ignition lags ranged from 10 to 400 msec depending upon temp, acid compn, fuel compn and metallic additives (Ref 2). Wetting agents significantly decrease ignition lag of HNO_3 combinations with furfuryl alcohol dicyclopentadiene. Oleamide, triethanolamine oleate, glyceryl oleate, sodium sulfonate and alkyl-aryl sodium sulfate were most effective (Ref 3). Ignitibility and delay times were also clearly related to chemical structure of the fuel. Comparisons have been made between hypergolic characteristics of primary, secondary, and tertiary amines as well as the effect of substituent groups such as methyl, hydroxy, and phenyl on the α - and β -carbon atoms of various amines with white fuming nitric acid oxidizer (Ref 4). With highly reactive combinations such as $N_2H_4 - H_2O_2$, N_2H_4 and $N_2H_4 - NH_3$ mixtures with RFNA (red fuming nitric acid) and WFNA (white fuming nitric acid) the mixing time is the rate-controlling step in the process and ignition delays in the order of a millisecond are observed (Ref 5). The National Advisory Committee for Aeronautics extensively studied ignition delays of nitric acid oxidants. Their noteworthy conclusions are summarized in Ref 6

The ignition delay phenomena have been extensively studied for hypergolic combinations of N_2O_4 with various fuels because of the almost exclusive use of this oxidizer in the upper stages of the US military and civilian space program. Propellant combinations used in specific launch vehicles are given in Ref 34. A summary of a literature and industry survey of the hypergolic ignition spike phenomena is given in Ref 35. The physics of spray formation, chemistry of combustion, physico-chemistry, gas dynamics, and transport are dealt with. Ignition limits have been detd for various combinations of N_2O_4 and N_2H_4 under press and temp conditions of space chambers of varying sizes. Vapor phase and condensed phases were investigated (Ref 36). The reactivity of N_2O_4 with Aerozine-50 (50/50 hydrazine/unsym dimethylhydrazine) was detd at pressures from 10^{-5} to 1 atm. At pressures

below 0.01 atm explosions and detonations occurred under certain specified conditions (Ref 37). Various physical phenomena influencing ignition delay of HNO_3 and N_2O_4 oxidizers and mixts include diameter of injection tube, stream velocity, mixing ratio, chamber pressure, fuel & oxidizer temps, water content of fuel & oxidizer. Fuel mixts investigated include furfuryl alc & primary amines, UDMH (unsym dimethylhydrazine) and phenylacetylene (Ref 38). Ignition delay data are given in Ref 39 for fuels made hypergolic by addition of UDMH. Included are alkanes, aldehydes, alcohols, esters, C_6H_6 and derivatives, olefins, naphthalene & derivatives, furan & derivatives, cyclohexane & derivs, and methylcyclopentane & derivs. The amount of UDMH required decreased with increasing chain length. Oxidizers included HNO_3 , N_2O_4 , H_2SO_4 and H_2O_2 . A mathematical model for the hypergolic ignition in space for N_2O_4 /MMH (monomethylhydrazine) and N_2O_4 /UDMH has been developed. It predicts ignition delay times for space rocket engines and ignition pressure spikes (Ref 40)

The vacuum ignition characteristics of flox/diborane (flox is a mixt of F_2 & liq O_2) and oxygen difluoride/diborane were investigated in 100-lb thrust rocket engines for possible use in space engines. Variables tested included hardware temp, propellant temp, oxidizer leading or lagging fuel, chamber press and injector configuration (Ref 41)

Hypergolic Oxidizer and Fuel Mixtures. A list of oxidizers and fuels which are hypergolic follows: RFNA with: aniline (Ref 7); N_2H_4 (Refs 8 & 9); H_2 (Ref 10); toluene (Ref 11); diethylenetriamine (Ref 8); MMH (Ref 8); UDMH 50% & N_2H_4 50% (Ref 8); ethylenediamine (Ref 8); UDMH 60% & diethylenetriamine 40% (Ref 8); pentaborane (Ref 8); triethylaluminum (Ref 12); diethylzinc (Ref 12); trimethylaluminum (Ref 12); diborane (Ref 12)

WFNA with: aniline (Ref 2); N_2H_4 (Ref 8); MMH (Ref 8); UDMH (Ref 8); UDMH 50% & N_2H_4 50% (Ref 8); diethylenetriamine (Ref 8); UDMH 60% & diethylenetriamine 40% (Ref 8); pentaborane (Ref 8); amines (Ref 4); JP-4 & dicyclopentadienyliron (Ref 13)

N_2O_4 with: H_2 (Ref 10, 14); pentaborane (Ref 8, 10); N_2H_4 (Ref 8, 10, 15, 16); MMH

(Ref 8, 10, 14, 17); ethylenediamine (Ref 8); diethylenetriamine (Ref 8); UDMH (Ref 8, 14); UDMH 50% & N_2H_4 50% (Ref 8, 10, 14, 18)

Oxygen with: N_2H_4 (Ref 10); UDMH 50% & N_2H_4 50% (Ref 10); pentaborane (Ref 10, 20); triethylaluminum (Ref 21); trimethylaluminum (Ref 22); boranes & derivatives (Ref 19)

Ozone with: diethylenetriamine (Ref 10); N_2H_4 (Ref 10); hydrogen (Ref 10); pentaborane (Ref 10); UDMH (Ref 10); trimethylaluminum (Ref 19); morpholines (Ref 24); polyamines (Ref 23)

H_2O_2 with: UDMH (Ref 10); UDMH 50% & N_2H_4 50% (Ref 8); diethylenetriamine (Ref 8); ethylenediamine (Ref 8); UDMH 60% & diethylenetriamine 40% (Ref 8); pentaborane (Ref 8); triethylaluminum (Ref 19); triethylborane and other borane derivatives (Ref 19); N_2H_4 (Ref 8, 25); MMH (Ref 8, 17)

Fluorine with: N_2H_4 (Ref 10); H_2 (Ref 10, 14); MMH (Ref 10, 17); pentaborane (Ref 10); triethylaluminum (Ref 14); triethylboron & other borane derivatives (Ref 19)

Oxygen/Fluorine (FLOX) with: ethylene (Ref 26); methane (Ref 26); propane (Ref 26); propylene (Ref 26); diborane (Ref 27)

ClF_3 with: N_2H_4 (Ref 8, 10, 16, 28); H_2 (Ref 10); MMH (Ref 8, 17); pentaborane (Ref 8, 10); UDMH (Ref 8); diethylenetriamine (Ref 8); ethylenediamine (Ref 8); UDMH 60% & diethylenetriamine 40% (Ref 8); kerosene (Ref 19); triethylaluminum (Ref 19); triethylboron (Ref 19); diborane (Ref 19); UDMH 50% & N_2H_4 50% (Ref 8, 10); PBAA (polybutadiene/acrylic acid/acrylonitrile) + NH_4ClO_4 + Al (Ref 29); polysulfide + NH_4ClO_4 + Al (Ref 29); polyurethane + NH_4ClO_4 + Al (Ref 29); double-base propellant (Ref 29)

ClO_3F with: UDMH 50% & N_2H_4 50% (Ref 8); diethylenetriamine (Ref 8); ethylenediamine (Ref 8); pentaborane (Ref 8); N_2H_4 (Ref 8, 10); H_2 (Ref 10); MMH (Ref 8, 10); UDMH (Ref 8, 10); UDMH 60% & diethylenetriamine (DETA) 40% (Ref 8, 10)

N_2F_4 with: NH_3 36% & N_2H_4 64% (Ref 10); N_2H_4 (Ref 10); H_2 (Ref 10)

Oxygen difluoride with: diborane (Ref 27); H_2 (Ref 10); UDMH 60% & diethylenetriamine 40% (Ref 10); MMH (Ref 10); RP-1 fuel (Ref 10)

BrF₅ with: N₂H₄ (Ref 8); MMH (Ref 8); UDMH (Ref 8); UDMH 50% & N₂H₄ 50% (Ref 8); diethylenetriamine (Ref 8); ethylenediamine (Ref 8); UDMH 60% & diethylenetriamine 40% (Ref 8); pentaborane (Ref 8)

ClF₃ with: N₂H₄ (Ref 30, 31); Li, Ca, Na, NaK and K (Ref 32)

Physical Properties. Physical properties and handling hazards for the following hypergolic propellant fuels and oxidizers are given in Ref 42: alkyl borane, aniline, ClF₃, F₂, N₂H₄, H₂, H₂O₂, MMH, RFNA, N₂O₄, O₂, pentaborane, ClO₃F, and UDMH

Thermochemical and Thermodynamic Properties. The heat release rate for the liq phase reaction of N₂O₄ & N₂H₄ was measured and found to be equal to that for HNO₃/N₂H₄ determined by Somogyi & Feiler (Ref 43). Both heat & gas release were detd for liq H₂O₄ with N₂H₄, MMH, and UDMH which were mixed by free jets impinging and quenched. Calorimetric and PVT measurements established total heat and gas release. Reactibility increases in order of: N₂H₄, UDMH, and MMH (Ref 44). Enthalpy, entropy, phase compn, press, temp, and sp vol for Aerozine 50 (50% N₂H₄ & 50% UDMH) have been detd and charted (Ref 45). Significant chem species and reactions in propellant exhausts containing C, H, O, N, F, Cl, and either Al, Be, B or Li were detd for use in nonequil performance calcs. Propellant systems included hypergolic liquid propellants and hybrid propellants (Ref 46). Important chem reactions in the following propellant mixts were used to describe the kinetics of non-equal expansion and calculated theoretical sp imp: O₂/H₂; F₂/H₂; N₂O₄/A50 (49% UDMH & 51% N₂H₄); ClF₃/N₂H₄; OF₂/B₂H₆; F₂/N₂H₄; FLOX (69.3% F₂ & 30.7% O₂)/RP-1; liq O₂/RP-1 (Ref 47). Theoretical performance calcs have been made for O₂, F₂/beryllium; lithium hydride/H₂ (Ref 48); aviation gasoline/fuming nitric acid (Ref 49); and oxygen difluoride/diborane propellants (Ref 50)

Explosion Properties. Occurrence of detonation within rocket engines employing certain aminated fuels and nitric acid propellants are related to the formation of amine or hydrazine nitrates which tend to decompose explosively under the influence of sudden temp or pressure rises (Ref 51). Tangential-mode rocket motor instabilities were analyzed using 1-dimensional, 2-phase

detonation wave as a reaction model. Theoretical analysis compared favorably with exptl data from the literature on N₂O₄-HNO₃/N₂H₄ rocket motor firings

TNT equivalent blast yields and fireball dimensions were detd experimentally for the hypergolic propellant N₂O₄/Aerozine 50 (Ref 53, 54). Explosive reactions have been reported for ClF₃ with methane and propane (Ref 55). Violent reactions occur between N₂O₄ and many halogenated hydrocarbon solvents (Ref 56). Most reactive are the partly chlorinated compds of C₂H₆, C₂H₄ & CH₄. Explosive sensitivity decreases in solvents: 1) with greater ratios of Cl:H atoms; 2) that are symmetrical; 3) with no double bonds and 4) with more F than Cl atoms

Propellant Performance Data. Specific impulse and chamber temperature for a number of more common hypergolic propellant combinations are in the following table. The values are based on shifting equilibrium conditions with a chamber pressure of 1000 psia. Data are from Ref 33

Chlorine Trifluoride (ClF₃)

Heat of formation, liquid, $\Delta H_f^\circ = -44.4$ kcal/mole

Density of liquid, 1.81 g/ml at 298°K

Melting point, -82.6°C

Boiling point, 11.3°C

Maximum Specific Impulse (1000 → 14.7 psia)

Fuel	Oxidizer	T _c , °K	ρ(g/cc)	Isp(Sec)
H ₂	92	3403	0.612	318
N ₂ H ₄	73	3882	1.48	293
B ₅ H ₉	88	4487	1.47	290
UDMH	75	3794	1.37	280
Polyethylene	77	3541	1.48	257
CH ₃ N ₂ H ₃	74	3647	1.42	283
DETA	75	3599	1.47	267

Bromine Pentafluoride (BrF₅)

Heat of formation, liquid, $\Delta H_f^\circ = -132$ kcal/mole

Density of liquid, 2.466 g/ml at 298°K

Melting point, -62.5°C

Boiling point, 40.3°C

Maximum Specific Impulse (1000 → 14.7 psia)

Fuel	Wt % Oxidizer	$T_c, ^\circ K$	$\rho(g/cc)$	Isp(Sec)
CH ₃ N ₂ H ₃	78	3264	1.76	235
B ₅ H ₉	92	4380	1.99	246
N ₂ H ₄	77	3323	1.85	244
UDMH	78	3215	1.68	231
DETA	78	3042	1.84	220

Hydrogen Peroxide (H₂O₂) 100%

Heat of formation, liquid, $\Delta H_f^\circ = -44.84$ kcal/mole
Density of liquid, 1.443 g/ml at 298°K

Maximum Specific Impulse (1000 → 14.7 psia)

Fuel	Wt % Oxidizer	$T_c, ^\circ K$	$\rho(g/cc)$	Isp(Sec)
H ₂	88	2404	0.435	322
B ₅ H ₉	73	3400	1.06	316
N ₂ H ₄	67	2923	1.26	286
UDMH	81	3008	1.25	283
Polyethylene	86.5	2999	1.30	277

Fluorine (F₂)

Heat of formation, liquid, -3.47 kcal/mole at 85.2°K
Density of liquid, 1.51 g/cc at 85.2°K
Melting point, -219.6°C
Boiling point, -188°C

Maximum Specific Impulse (1000 → 14.7 psia)

Fuel	Wt % Oxidizer	$T_c, ^\circ K$	$\rho(g/cc)$	Isp(Sec)
H ₂	89	3964	0.468	410
N ₂ H ₄	69	4688	1.31	363
B ₅ H ₉	82	5101	1.20	360
UDMH	71	4342	1.19	344
Polyethylene	72.5	4382	1.28	325
NH ₃	77	4543	1.15	357

Nitrogen Tetroxide (N₂O₄)

Heat of formation, liquid, $\Delta H_f^\circ = -5.4$ kcal/mole
Density of liquid, 1.43 g/cc at 298°K
Melting point, -11.2°C
Boiling point, 21°C

Maximum Specific Impulse (1000 → 14.7 psia)

Fuel	Wt % Oxidizer	$T_c, ^\circ K$	$\rho(g/cc)$	Isp(Sec)
H ₂	84	2660	0.352	342
B ₅ H ₉	77	4266	1.10	306
N ₂ H ₄	57	3257	1.21	291
UDMH	72	3429	1.16	286
Polyethylene	80	3444	1.29	276
CH ₃ N ₂ H ₃	68.5	3390	1.19	288
DETA	74	3369	1.27	278

Red Fuming Nitric Acid (RFNA)

Red fuming nitric acid contains 2 weight percent H₂O,
84.6% HNO₃ and 13.4% N₂O₄

Heat of formation, liquid, $\Delta H_f^\circ = -41.0$ kcal/mole
Density of liquid, 1.57 g/cc at 298°K
Melting point, -49°C
Boiling point, 66°C

Maximum Specific Impulse (1000 → 14.7 psia)

Fuel	Wt % Oxidizer	$T_c, ^\circ K$	$\rho(g/cc)$	Isp(Sec)
B ₅ H ₉	77	3486	1.17	298
N ₂ H ₄	60	3003	1.28	278
CH ₃ N ₂ H ₃	71	3191	1.28	278
UDMH	76	3008	1.27	272
Polyethylene	83	3230	1.39	268

Written by E. L. CAPENER

Refs: 1) J.D. Broatch, Fuel, 24-5, 106 (1950)
2) S.V. Gunn, JAmRocketSoc 22, 33 (1952)
& CA 47, 8341 (1953) 3) M.L.J. Bernard,
FifthSymp(Intrnl)Comb, 217, Reinhold, NY
(1955) 4) L.R. Rapp & M.P. Strier, JetPropul-
sion 27, No 4, 401 (1957) & CA 51, 8405
(1957) 5) M. Kilpatrick & L. Baker, Jr, Fifth
SympComb, Reinhold, NY (1955) 6) G. Morrell,
"Summary of NACA research on ignition lag of
self-igniting fuel-nitric acid propellants," NACA
RM E57G19 (Oct 3, 1957) 7) R.P. Rastogi
et al, IndianJChem 2, No 8, 301 (1964) & CA
61, 14453 (1964) 8) A.F. Duncan et al, "A
study of hypergolic bipropellant mass explosion
for attitude control of spacecraft," Final Rept
No 5915 (Jan 15-Aug 31, 1962), Marquardt

- Corp, Van Nuys, Calif (Aug 1964) (AD-450 129) 9) J.J. Chilenski, USP 3120738 (1964) & CA 60, 15676 (1964) 10) J. Tubeuf & J. Bedel, "Considerations on rocket propulsion for an aerospace vehicle," Paper presented at Eurospace Conf, Brussels, Jan 23-24, 1964 (NASA N 65-24027) 11) G. Hennings & G. Morrell, "Preliminary investigation of a chemical starting technique for acid-gasoline rocket propellant system," Res Memo E52K21, Natl Advisory Committee for Aeronautics, Wash, DC (Jan 1953) 12) B. Lewis, USP 3177652 (1965) & CA 63, 5442 (1965) 13) C.J. Pedersen, USP 3038299 (1965) & CA 57, 10094 (1962) 14) A. Corbett et al, "Hypergolic ignition at reduced pressure," Rept No AFPRL-TR-64-175, (May 1-Sept 30, 1964), Thiokol Chem Corp, Denville, NJ, (1964) (AD-610 144) 15) R. Friedman et al, "A study of explosions induced by contact of hydrazine-type fuels with N_2O_4 ," Final Rept No ASD-TDR-62-685, (June 1, 1961-May 31, 1962), ARC, Alexandria, VA (1962) (NASA N 63-17985) 16) J.J. Chilenski, USP 3120738 (1964) & CA 60, 15676 (1964) 17) O.A. Knight, Jr, Petrol Refiner 41, No 2, 179 (1962) 18) A.B. Willoughby et al, "Summary of existing information concerning the explosive potential of the hypergolic propellant combination N_2O_4 /50% UDMH-50% N_2H_4 ," Rept No AFRPL-TR-65-27, United Research Services Corp, Burlingame, Ca, April 1965 (AD-464 339) 19) B. Lewis, USP 3117652 (1965) & CA 63, 5443 (1965) 20) H.C. Baden et al, JPhysChem 62, 331 (1958) & CA 52, 11425 (1959) 21) J.W. Gregory & D.M. Straight, "Ignition of hydrogen-oxygen rocket combuster with ClF_3 & triethylaluminum," NASA TN-D-684, NASA, Washington, DC, April 1961 22) C.F. Cullis et al, ProcRoySoc (London) 289, 413 (1965) & CA 64, 4899 (1966) 23) Anon, Brit P 804590 (1958) & CA 53, 9620 (1959) 24) C.R. Scott & A.L. Ayers, USP 2771738 (1956) & CA 51, 3969 (1957) 25) M. Kilpatrick & L.L. Baker, Jr, "A study of fast reactions in fuel-oxidant systems," Fifth Symp Comb, Reinhold, NY, (1955) 26) S.A. Masier et al, "Hypergolic ignition of light hydrocarbon fuels with fluorine-oxygen (FLOX) mixtures," Western States Sect Combust Inst, Paper, WSCI 65-23 (1965) 27) G.R. Mistler & T.F. Seamans, "Vacuum ignition characteristics of flox/diborane and oxygen difluoride/diborane," NASA Contract Report 1969, NASA-CR-100678. Avail CFSTI. From SciTechAerosp Rep 7 (12), 2196 (1969) 28) W.B. Powell et al, " ClF_3 - N_2H_4 liquid propellant evaluation and rocket motor development," TechRept 32-305, Jet Propulsion Lab, Calif Inst Tech, Pasadena, Ca, (May 1963) (NASA N63-21722) 29) H. Allen, Jr & Pinna, "Relative ignitability of typical solid propellants with ClF_3 ," NASA TN-D-1533, NASA, Wash, DC, (Jan 1963) (NASA N63-11616) 30) R.F. Sawyer et al, AIAA J, 6, 11, 2111 (1968) & CA 70, 13118 (1969) 31) M.C. Branch & R.F. Sawyer, JSpacecraft & Rockets 6, 11, 1322 (1968) & CA 72, 45648 (1970) 32) R.A. Rhein, JSpacecraft & Rockets 6, 11, 1328 (1968) & CA 72, 45648 (1970) 33) Propellant Performance Data, Callery Chemical Co (1961) 34) Aviation Week & Space Technology (March 19, 1973) 115 35) H.E. Perlee & T. Christos, "Summary of literature survey of hypergolic ignition spike phenomena, Phase I," NASA Accession No N66-39712, Rept No NASA-CR-78986, SciTechAerosp Rept 4 (24) 4813 (1966) & CA 66, 11750 (1967) 36) R.L. Chuan & P.C. Wilber, JSpacecraft & Rockets 4 (2), 282 (1967) & CA 66, 97058 (1967) 37) J.A. Simmons et al, AIAA J, 6 (5), 887 (1968) & CA 69, 4076 (1968) 38) G. Spengler et al, "Measurements of ignition delays of hypergolic liq rocket propellants," NASA Accession No N64-24376, Rept WSS/CI 64-12, avail CFSTI (1964) 39) G. Spengler & J. Bauer, Brenstoff-Chem 46 (4), 117 (1965) & CA 63, 4087 (1965) 40) T.F. Seamans et al, "A fundamental model of hypergolic ignition in space-ambient engines," IAA Accession No A67-12284, Avail AIAA, Paper No 66-950 (1966) & CA 67, 34559 (1967) 41) G.R. Mistler & T.F. Seamans, "Vacuum ignition characteristics of flox/diborane & oxygen difluoride/diborane," NASA Rept No NASA-CR-100678, Sci Tech Aerosp Rept 7 (12), 2196 (1969) & CA 71, 72501

(1969) 42) "The Handling and Storage of Liquid Propellants," Office of the Director of Defense Research and Engineering, Wash, DC, Govt Printing Office, Jan 1963 43) B.R. Lauver & E.A. Tkachenko, "Heat-release rate for the liq nitrogen tetroxide/hydrogen reaction by Somogyi & Feiler's method," NASA Rept NASA-CR-73608, avail CFSTI, SciTechAerosp Rept 7 (6), 946 (1969) 44) S.E. Rodriguez, "Heat & gas release meas on liq hypergolic propellants," (paper) West States Sec/Comb Inst, 70-26 (1970) & CA 74, 77953 (1971) 45) J.P. Copeland & J.A. Simmons, "Determination of thermodynamic properties of Aerozine-50," NASA rept NASA-CR-92463 & NASA-CR-92464, avail CFSTI, SciTechAerosp Rep 7 (6), 1058 (1969) & CA 71, 72488 (1969) 46) P.I. Gold, "Chemical species and chemical reactions of importance in nonequilibrium propellant performance calculations," NASA Accession No N66-33714, Rept No NASA-CR-65442, avail CFSTI, SciTechAerosp Rept 4 (19), 3722 (1966) & CA 67, 4484 (1967) 47) S.S. Cherry & L.J. van Nice, Pyrodynamics 6 (3-4), 275 (1969) & CA 70, 98394 (1969) 48) R.E. Lo, "Theoretical performance of the multicomponent rocket propellant system (oxygen, fluorine/beryllium, lithium hydride)/hydrogen," Deutsche Versuchsanst Luft- und Raumfahrt Rept 1968, DLR-Mitt-68-21 (Ger), avail CFSTI, SciTech Aerosp Rept 7 (1), 161 (1969) & CA 71, 72491 (1969) 49) S.E. Flygar, "Thermochemical calculations for rocket motors using the components aviation gasoline MC 77 and fuming nitric acid," US AT Energy Comm 1967, FOA-2-A-2491-42 (Swedish), avail CFSTI, SciTechAerosp Rept 7 (6), 841 (1969) & CA 71, 72492 (1969) 50) D.A. Bittker, "Theoretical nonequilibrium performance of oxygen difluoride-diborane rocket propellant," NASA Tech Note NASA-TW-D-4992 (1969), avail CFSTI, SciTechAerosp Rept 7 (6), 1058 (1969) & CA 71, 72494 (1969) 51) M.L.J. Bernard & J. Dufour, Eighth Symp (Intl) on Comb, 1074, Williams & Wilkins Co, Baltimore, Md, (1962) 52) P. Shen & T.C. Adamson, Jr, Astronaut Acta 17 (4-5), 715 (1972) & CA

78, 32298 (1973) 53) R.E. Pesante et al, "Blast and fireball comparison of oxygenic and hypergolic propellants," NASA final rpt NASA-CR-69088 (1964) 54) R.E. Pesante et al, "Blast and Fireball comparison of cryogenic and hypergolic propellants with simulated tankage," NASA rept NASA-CR-69114 (1964) 55) C.B. Baddiel & C.F. Cullis, Eighth Symp Comb, 1089, Williams & Wilkins, Baltimore, Md, (1962) 56) R.E. Turley, ChemEngrNews 42 (47), 53 (1964) & CA 62, 2661 (1965)

Hyperol or Perhydrate. A tradename for the compound of hydrogen peroxide and urea. $\text{OC}(\text{NH}_2)_2 \cdot \text{H}_2\text{O}_2$, solid, decomp above 82° (Ref 2). It is claimed to be an advantageous replacement for hydrogen peroxide in chemical analyses (Ref 1)

Refs: 1) J.R. Booer, Chem & Indust 44, 1137 (1925) & CA 20, 158 (1926) 2) E. Janecke, RecTravChim 51, 579 (1932) & CA 26, 4747 (1932)

Hypervelocity Gun. A patent by Clark & Boltz (1959) claims a device consisting of a compression chamber & piston energy absorber that produces shear projectiles at velocities of 10,000 to 15,000 ft/sec which is claimed to be 5 times greater than velocities that are produced by impact. Applications for this device include simulation of possible effects of meteor particles on missiles in outer space and general studies of high-velocity particles colliding with various materials

Hypervelocity firings into mixtures of hydrogen with air or with oxygen were studied by H. Behrens et al and reported at 10th Symp Combstn (1964), pp 245-52

Refs: i) A.B.J. Clark & P.T. Boltz, USP 2882796 (1959)

2) Anon, Ordnance 44, 468 (1959)

Hypervelocity Impact: Dependence of Crater Dimensions on Impact Velocity. Craters in copper and lead, produced by hypervelocity impact, were measured and the dimensions correlated with impact vel. The results indicate that craters scale with ca the 1.7 power of vel, in agreement with computer physics results based upon hydrodynamic calculations

Ref: J.H. Kineke Jr, BRL Memo Rept 1652
(May 1965) (Title as above)

HYPOCHLOROUS ACID AND HYPOCHLORITES

Hypochlorous Acid (Unterchlorige Säure in Ger), HClO or HOCl; known only in aq solutions. Although chlorine water was prepd as early as 1774 by C. W. Scheele (Ref 1; p 243), it was not known that chlorine reacted with water, $\text{Cl}_2 + \text{H}_2\text{O} = \text{HClO} + \text{HCl}$, forming a new acid, HClO. A. J. Balard first identified it; he prepd not only an aq solution of the acid, but also isolated the anhydride, chlorine monoxide

In the preparation of hypochlorous acid from chlorine and water, the yield is very low, on account of the small solubility of chlorine in water. The yield of HClO can be increased either by adding an insoluble oxide or carbonate which forms a sparingly soluble chloride. For instance, on adding mercuric oxide, the reaction proceeds; $2\text{Cl}_2 + \text{H}_2\text{O} + \text{HgO} = \text{HgCl}_2$

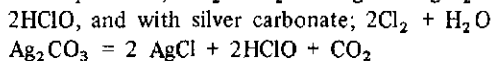

Another way to increase the yield is to pass additional chlorine into soda or lime solutions of chlorine; $\text{Cl}_2 + \text{Na}_2\text{CO}_3 + \text{H}_2\text{O} = \text{NaClO} + \text{NaCl} + \text{H}_2\text{CO}_3$, followed by acidification with H_2SO_4 and distillation of the liberated HClO

The acid can also be made by the action of water on chlorine monoxide, Cl_2O . This reaction is accompanied by the evolution of 4 kcal of heat per mol

Hypochlorous acid is a weak acid with a dissociation constant equal to 3 to 4 x 10^{-8} , which is about 1/600th the strength of acetic acid. When it is stored it slowly decomposes according to the following equations:

$2\text{HOCl} = 2\text{HCl} + \text{O}_2$ or $3\text{HClO} = 2\text{HCl} + \text{HClO}_3$. Both reactions are greatly accelerated by light. The first of these reactions makes hypochlorous acid a strong oxidizing agent

Hypochlorous acid reacts with inorganic bases with the formation of salts, called hypochlorites. In reactions with organic compounds, the acid may act not only as an oxidizer (see above) but also as a chlorinating agent (in the case of saturated compounds) or the addition of HO-Cl to the double linkage C=C to form a chlorhydrin; $\text{R}_1\text{C} = \text{CR}_2 + \text{HO-Cl} = \text{R}_1\text{C}(\text{OH})\text{C}(\text{Cl})\text{R}_2$

Solutions carrying up to 1% hypochlorous

acid, free from metals and protected from strong light, may be stored for a day without important loss. Solutions up to 20% may be kept for a short time at room temp, and 30% solutions may be kept for a long time at -20° (Ref 3, p 694)

For more information on the properties of hypochlorous acid, see Refs 1 & 2

Hypochlorites. The combination of the hypochlorite ion with a metallic ion or organic radical is called a hypochlorite. The inorganic compounds are called salts, while organic hypochlorites are esters

The first hypochlorites (those of sodium and potassium) were prepd in solution, in 1788, by C. L. Berthollet by treating solutions of the corresponding hydroxides with chlorine; $2\text{NaOH} + \text{Cl}_2 = \text{NaCl} + \text{NaClO} + \text{H}_2\text{O}$

In 1834, A. J. Balard prepd solutions of various hypochlorites by mixing aq hypochlorous acid with alkalis, magnesium, copper oxide, zinc oxide etc, avoiding an excess of acid

J. L. Gay-Lussac dissolved two mols of chlorine monoxide, Cl_2O , in a solution containing 1 mol of K_2O and then evaporated the resulting solution in vacuo. This gave solid potassium hypochlorite

The following inorganic hypochlorites are described in literature; aluminum (very unstable), ammonium (very unstable), barium, calcium, cupric, lithium, magnesium, potassium, silver (unstable), sodium, strontium and zinc. None of these salts is used in explosives or is explosive per se, but some of them are used in industry

However, when small amounts of damp S and calcium hypochlorite are mixed, a brilliant crimson flash is observed accompanied by the scattering of molten burning S (Ref 9)

Also, according to J. Weichherz, Chem Ztg, 52, 729-30 (1928), a mixture of Ca hypochlorite with combustibles explodes on heating (See also Ref 2)

Calcium hypochlorite has been used to neutralize toxic explosion gas in mining (Ref 8): Explosion of 1 kg detonite 10A & ammonite No 6ZhB yields 42-56, and 58-81 l poisonous gases, respectively. Use of ampules containing pyrolusite, NaHCO_3 , or Ca hypochlorite (15-25% of the explosive wt) as neutralizing substances neutralized 50% of the poisonous gases &

decreased by 30% the required ventilation time of the mine galleries. Hydrogen peroxide (3%), Ca hypochlorite, or water were introduced in polyethylene ampules (vol 250 m³) into the bore hole, whose opening was hermetically sealed by a "hydroseal," and water was introduced into the bore hole under pressure

Analysis of Hypochlorites.

Methods of determination of hypochlorous acid and hypochlorites are given in Ref 2, pp 292-296

According to Scott (Ref 5, p 262), hypochlorites decolorize indigo, but do not decolorize KMnO₄ solutions. If arsenous acid is present, indigo is not decolorized until all the arsenous acid has been oxidized to the arsenic form (distinction from chlorous acid and chlorites). A quantitative method of determination of hypochlorites in the presence of chlorine by using the KI method, is given in Scott (Ref 5, p 274)

Feigl (Ref 6) gives a spot test for hypohalogenates using benzidine reagent and Welcher (Ref 7) gives several qualitative and quantitative tests

Refs: 1) Mellor 2, (1922), 243-81 2) Gmelins Handbuch, Syst No 6, pp 249-96 3) Kirk & Othmer, 3, pp 681-696 (1948) (Includes 43 refs on hypochlorous acid and hypochlorites) 4) Ullmann (2nd ed), 3, 345 (1951) 5) W.W. Scott & N.H. Furman, Standard Methods of Chem Analysis, Van Nostrand, NY (1939), 1, pp 262 & 274 6) F. Feigl, "Qualitative Analysis by Spot Tests," Elsevier, Amsterdam (1946), p 242 (A drop of 2% solution of benzidine in dil AcOH is mixed with a drop of neutral (or acetic acid) solution of the sample on a spot plate. All hypohalogenates give a blue color, due to the oxidation of benzidine) 7) F. J. Welcher, Organic Analytical Reagents, Van Nostrand, NY (1947), 1, p 150 (determination of hypochlorites by the phenol method); 2, p 434 (by the m-phenylenediamine method); 2, p 438 (by the p-phenylenediamine method); 4, p 241 (by the codeine method); 4, p 390 (by the resorufin method) and 4, p 510 (by the indigo carmine method) 8) V.E. Brylyakov et al, Gorn Zh 1966 (12) 55 & CA 66, 57689 (1967) 9) S.A. Katz & D.M. Scheiner, Chem Eng News, 46, (29), 6 (1968) & CA 69, 64247 (1968)

Organic Hypochlorites (Esters of Hypochlorous Acid). Methods of preparing alkyl esters of hypochlorous acid are given under individual compounds, but a general method, recently proposed, is via the reaction of HClO with the appropriate alcohol in solution (preferably in freon but pet ether, carbon disulfide or benzene can also be used)(Ref 8). The lower members are unstable, mobile, yellow oils and most of them explode when brought into contact with a flame or when exposed to bright light. In the absence of a flame or light, all of them, except the tertiary compounds, decompose spontaneously on standing (Ref 8). According to Comastri (Ref 6), they are much more stable if any HCl, formed as a result of the reaction, is immediately removed by neutralization with NaHCO₃ (See also under Ethyl Hypochlorite)

The decomposition reactions of the primary, secondary and tertiary hypochlorites are as follows:

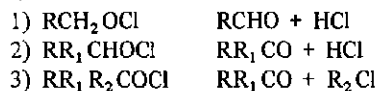

In reaction (1), an aldehyde is formed, in (2), a ketone and in (3) a ketone and an alkyl chloride. Reaction (3) only proceeds on heating

In general, the esters are strong oxidizing and chlorinating agents and they explode on contact with copper powder

Some aliphatic hypochlorites are described below:

Amyl Hypochlorites. C₅H₁₁ClO; yellow oils; may be prepd by bubbling chlorine through an aq emulsion of the corresponding alcohol, or by shaking a CCl₄ solution of an alcohol with an aq solution of HClO (Refs 2, 4 & 5)

All of these esters, especially the isoamyl- are unstable; the ester of the tertiary alcohol, (CH₃)₂C(ClO)C₂H₅, is more stable than the others; it boils at 76° at 752mm and decomposes in sunlight, but keeps fairly well in the dark.

Ref: Beil 1, 423 & [433]

Butyl Hypochlorites. C₄H₉ClO; yellow oils; may be prepd by methods similar to those for the amyl hypochlorites. These esters, especially that of isobutyl alcohol, are unstable

The esters of n-butyl- and sec-butyl- alcohols explode when exposed to light. The tertiary

butyl hypochlorite, $(\text{CH}_3)_3\text{C}(\text{OCl})$, is more stable than the others. Its bp is 79.6° at 750mm and d is 0.9583 at 18° (Refs 1, 4 & 5) (Beil 1, [396]—the primary hypochlorite, $\text{CH}_3(\text{CH}_2)_3(\text{OCl})$, [402]; sec-butylhypochlorite, $\text{C}_2\text{H}_5\text{CH}(\text{CH}_3)\text{OCl}$ and [415]—tertiary compound; [411])

Ethyl Hypochlorite. $\text{CH}_3\text{CH}_2\text{Cl}$; mw 80.52, OB to CO_2 and Cl_2 -109.3%, $d=1.013$ at 6° , bp 36° at 758mm. Yellow, volatile, oily liquid; was prepd in 1885 by Sandmeyer (Ref 3) by bubbling ClO_2 through cold ethanol or by mixing a cold aq. solution of HClO with cold ethanol

Other methods of preparation are given in Refs 1 to 5

Comastri (Ref 6) gives the following method of preparation; Place in a separatory funnel a solution containing 23g of NaOH in 23g of ethanol and 200ml H_2O . Cool in an ice-salt bath and pass in chlorine through a tube reaching to the bottom of the container. The resulting ethyl hypochlorite collects in the form of an oil layer on the surface of the liquid and may be separated easily. It is washed with a cold saturated solution of NaCl , followed by a cold satd NaHCO_3 solution, and immediately dried (while cold) over CaCl_2 . The yield is about 72% of theory. The following reaction takes place:
 $\text{C}_2\text{H}_5\text{OH} + 2\text{HClO} = \text{C}_2\text{H}_5\text{ClO} + \text{HCl} + \text{H}_2\text{O}$

Comastri claims that, contrary to the literature, the action of light on $\text{C}_2\text{H}_5\text{ClO}$ is inappreciable and the material can be kept for several hours at room temp, provided that all HCl (formed as result of the above reaction) is promptly neutralized with NaHCO_3 solution. If the HCl is not removed, the hypochlorite decomposes (or even explodes) spontaneously in a few minutes, on account of the following reaction;

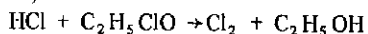

Ethylhypochlorite is insol in w; sol in bz, chl and eth. It explodes violently on heating or by the action of direct sunlight (Beil 1, 324 (164) and [325])

Methyl Hypochlorite. CH_3ClO ; mw 66.49; bp 12° at 726mm. Gaseous substance; was prepd by Sandmeyer (Refs 2 & 3) by bubbling chlorine through a cold solution of NaOH in methanol. Explodes on contact with flame (Beil 1, 282 and [271])

Pentyl Hypochlorites. Same as Amyl Hypochlorites

Propyl Hypochlorites. $\text{C}_3\text{H}_7\text{ClO}$; yellow oily substances. May be prepd by methods similar to the ones mentioned under Amyl Hypochlorites (see above)

All the propyl hypochlorites, especially the isopropyl, are unstable. n-Propyl-, as well as the isopropyl hypochlorites, explode when exposed to light (Refs 2, 4 & 5) (Beil 1, [368] -n-propylester; [381] -isopropylester)
 Refs: 1) Beil, 1 (see under the individual compounds) 2) Gmelins Handbuch, Syst No 6, p 264 3) T. Sandmeyer, Ber 18, 1767 (1885); 19, 857 (1886) 4) F.D. Chattaway & O.G. Backeberg, JCS 123, 3001 (1923) & 125, 1097 (1924) 5) M.C. Taylor et al, JACS 47, 397 (1925) 5a) J. Durand & R. Naves, BullSocChim de France (4), 37, 719 & 1154 (1925) 6) H.T. Comastri, Anales A Soc Quim Argentina 27, 41 (1939) & CA 33, 6793 (1939) 7) N.V. Sidgwick, Chemical Elements and Their Compounds, Clarendon Press, Oxford, England (1950), v 2, pp 1217-1219 8) R. Fort & L. Denivelle, BullSocChim, France 1954, 1109 & CA 49, 12271 (1956)

Hypophosphites are salts of *hypophosphorous acid*, $\text{H}(\text{H}_2\text{PO}_2)_3$ or $\begin{array}{c} \text{O} \\ \parallel \\ \text{H}:\text{P}:\ddot{\text{O}}:\text{H} \\ | \\ \text{H} \end{array}$

They are generally prepared by the action of phosphorous on the corresponding salt in alkaline solution. The free acid is prepd by treating Ba-hypophosphite with sulfuric acid. It is monobasic and is a strong reducing agent (Ref 6)

Hypophosphites have been claimed as ingredients of priming compositions: Lead hypophosphite/MF/Dinitrophenylazide/ $\text{K}_2\text{Ba}(\text{NO}_3)_4$ & Sb_2S_3 (Ref 2); alkali, alkaline earth, NH_4 & Mn hypophosphites mixed with oxidizers such as Pb or Ca nitrate (Ref 4); complex salt hypophosphites suitable for use in detonators are claimed to be formed from equimolar amounts of normal or basic Pb styphnate and Pb hypophosphite (Ref 5)

An early French patent claims the manufacture of explosives based on hypophosphites mixed with oxidizers (Ref 1)

Burrows has claimed that the double salt of Pb hypophosphite and Pb nitrate is a suitable ignition composition around the bridge wire of a blasting cap. He also claimed such mixture as Ca hypophosphite and K chlorate (Ref 3)
Refs: 1) Serrant & Boilleau, French Pat 397392 (1908) & CA 4, 2733 (1910) 2) V.J. Kelson, Austral Pat 104189 (1938) & CA 32, 8782 (1938) 3) L.A. Burrows, USP 2173270 (1939) & CA 34, 627 (1940) 4) W. Bruen, USP 2175826 (1939) & CA 34, 887 (1940) 5) J.D. McNutt & S.D. Ehrlich, USP 2352964 (1944) & CA 38, 6098 (1944) 6) CondChem Dict, 8th Edit (1971), p 463

Hyporka. A glass fiber insulation used in rockets
Ref: A.J. Zachringer, "Solid Propellant Rockets," Wyandotte, Mich (1955), p 152

"Hyros" Explosives. Prepd by nitrating a mixt of resin, and cereal or flour, adding $KClO_3$ and sufficient water to make a homogeneous paste. A typical compn is resin 53, wheat flour 27 & nitric acid of 20°Bé 20%; the nitrated product 1p is mixed with $KClO_3$ 3 parts & water to make a paste which is molded into blocks
Ref: Leckzinski, FrP 395635 (1908) & CA 4, 2733 (1910)

I

IASP. Initial Average Sustained Pressure (in rockets) is the average pressure during the first part of the run, after full pressure is reached. IASP is illustrated in the following Fig

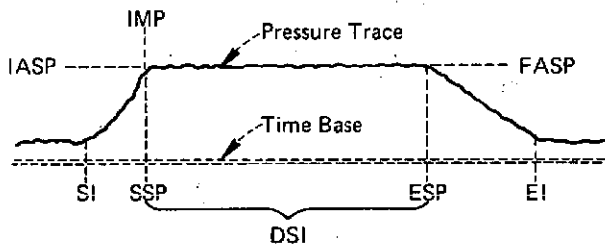

Definition of Values Measured on Film Strips

Ref: F. Bellinger et al, IEC 38, 166 & 167 (1946)

ICC. Interstate Commerce Commission (qv)

Ice Blasting by Means of Explosives. In order to prevent ice jams in rivers and keep them flowing during the thawing period, it is often necessary to help nature by using explosives. Considerable damage can be done to bridges, boats, piers, etc if the ice jams are not removed at the right time. Ice jams also produce flooding

An interesting description of breaking up the ice jams in the Raritan river in New Jersey is given by Berliner

Ref: Berliner, Expls (1953), pp 24-28

ICI. Imperial Chemical Industries Ltd of London, England, has extensive equity holdings in the commercial explosives industry throughout the world. When ICI was formed in 1926 one party to the merger was Nobel Industries Ltd which involved major British explosives interests and particularly the factory set up by Alfred Nobel in 1871 at Ardeer, Stevenston in Scotland

Nobel's Explosives Company Ltd (NEC) with its headquarters at Stevenston, is a wholly owned subsidiary of ICI and has been given responsibility for the explosives interests of that company. NEC operates a complete industrial explosives industry in Great Britain and operates plants and services in other countries as well as supplying explosives and accessories to many customers throughout the world

ICI has a majority shareholding in other

companies with major explosives interests of which the most important are Canadian Industries Limited (CIL), ICI Australia Ltd, Indian Explosives Ltd and the Philippines Explosives Corporation. ICI also has a substantial holding in African Explosives and Chemical Industries Ltd, which operates the largest commercial explosives factory in the world at Modderfontein (See *Nobel's Explosives Company* in a future Vol)

ICT. Abbr for Igniter Composition for Tracers (qv)

Ideal and Nonideal Detonations. See Detonations, Ideal and Nonideal in Vol 4, pp D389-R-D390-R

IDENTIFICATION OF AMMUNITION AND EXPLOSIVE DEVICES

The identification of ammunition is a very complex art. It may be accomplished in any one of a number of methods such as examination of physical size, shape, color markings, stencilled markings, metal stampings, and data written on the packaging material

Historically speaking, early types of ammunition were identified solely by size and shape. As the art of waging war became more complex and sophisticated, logistics support to the field also became more complicated. It was discovered that some means other than size and shape would be necessary for rapid identification of ammunition on the battlefield. According to available information the first distinctive identification of ammunition was developed by the French. This method was the application of paint to cannon projectiles to designate the various types used on board ship. This practice was abandoned prior to 1803 because of the lack of a suitable colored lacquer or paint which would hold its color and remain on the projectiles during shipboard storage at sea

By 1803, the British had adopted an identification system consisting of various colored letters and numbers applied to the ends of powder barrels to designate the type of propellant, the size of grain, special ingredients used in its manufacture, and method of processing.

By the 1850's, the British had a standardized color code for identifying smooth bore artillery projectiles. This code consisted of a black body color with white, red and/or yellow bands to designate various loadings

An all white body denoted steel shot and a black body with one white band designated chilled iron shot. About the time of the American Civil War the US Navy adopted a similar code for the rapid identification of projectiles aboard ship. Black, white, red, yellow and blue were used to permit rapid identification of different projectile loadings or functional features. In this same time period, in both the American and British service, metal stampings were applied to the exterior surface of projectile bodies as proof of acceptance by the inspectors and to identify the manufacturer. With the introduction of studded projectiles in the British Land Service, metal stampings were employed to indicate various arsenal modifications to the projectiles. The painting system employed for smooth bore projectiles was retained and modified to allow for various new types. One example was a black body with one blue band to designate a ring projectile

With the advent of breech loading artillery, the British retained the same basic black projectile body color with colored bands until new special types of projectiles were introduced. An example of this was a yellow body with a red band on the nose to denote high explosive, "lyddite" (Picric Acid) filled projectiles. When plaster kits were assembled to these projectiles a wide brown band was painted on the projectile nose and one narrow red band painted underneath it. In addition to the color markings, metal stamp and stencil markings were also employed for identification purposes

The US Army did not adopt a standardized color code for artillery projectiles until the turn of the 20th century. At this time, there was one color code system for mobile army ammunition, one for seacoast ammunition and one for navy ammunition. Each color code was distinctively different, because there was no attempt to standardize identification among the then three services

By this time, breech loading weapons had been improved by development of the brass cartridge case, the base of which provided a good surface for placing information. At first, only the weapon bore size and/or the manu-

facturer's name was applied to the cartridge case base. Later, as it became necessary to better identify ammunition components because of mishaps or malfunctions in the field, both metal stampings and/or ink stencil marks were applied to every component that had a surface large enough to accept such a mark without detrimental distortion occurring

By the outbreak of World War I practically every major power in the world had one or more color code systems to identify their projectiles

By this time the art of pyrotechny was so well advanced that many different types of signals were being employed. Because of the vast number of different signaling devices developed, various identification systems were developed by the major powers, which consisted of colors, raised dots and milled case edges and stencilling. In addition, when special purpose small arms cartridges were developed, some means of identification had to be developed. Colored bullet tips, partially or completely blackened cartridge cases and metal stamp base markings were employed for small arms ammunition identification

Aircraft bombs were introduced in World War I, and soon, various special purpose types were developed. Therefore, a color code was developed. Again each service (land and sea) of the major powers developed their own identification system consisting of colored bodies, colored bands, metal stampings and ink stencil markings

In the same time period, specialized fuzes for both artillery projectiles and bombs were developed. To designate differences in delay or weapon to be used with, artillery fuzes were color coded for rapid identification in the field

In the early 1960's, a concerted effort was undertaken by the NATO countries for the establishment of a standardized color code for the identification of ammunition of all types except small arms ammunition below 20mm in caliber. The following color code was adopted and is being used by most NATO countries. The colors adopted and their significance are as follows:

<u>Color</u>	<u>Significance</u>
Yellow	1) HE ammunition 2) Presence of explosive a. sufficient for HE function b. particularly hazardous to user

<u>Color</u>	<u>Significance</u>		
Brown	1) Rocket motors 2) Presence of explosives a. sufficient for low-explosive function b. particularly hazardous to user	OP 4 TM 9-1900	Ammunition Instructions for the Naval Service May 1943 Ammunition General, 1941 Ammunition General, 1942 Ammunition General, 1945 Ammunition General, 1956
Gray	Ammunition containing toxic or irritant agents. Presence of high or low explosive components is indicated by yellow or brown bands	V-650 TM 9-1901	Ammunitionsregister för Armén Beställes hos KATF/TFB, Stockholm 80, 1960 Artillery Ammunition, 1944 Artillery Ammunition, 1950 Artillery Ammunition, 1967
Gray with red band or bands	Ammunition containing irritant agents	TM 9-1980	Bombs for Aircraft, 1942 Bombs for Aircraft, 1944 Bombs for Aircraft, 1950
Gray with dark green band or bands	Ammunition containing toxic agents	TM 9-1985-1	British Explosive Ordnance, 1953
Black	Armor defeating ammunition	Supplement to Intelligence Bulletin No 85	British Navy Projectiles and Fuzes, June 1945
Silver or Aluminum	Countermeasure ammunition such as radar echo leaflets		Bombs & Hand Grenades by Bertram Smith, E.P. Dutton & Co NY 1918
Light Green	Smoke or marker ammunition. Presence of high or low explosive indicated by yellow or brown bands		Catalogue of Enemy Ordnance Materiel Vols 1 & 2, US Army Ordnance Depot 1 March 1945
Light Red	Incendiary ammunition or presence of highly flammable material designed to produce damage by fire		Catalog of Cartridge Manufacturers and Base Markings by B.D. Munhall & H.P. White 1944
White	Illuminating ammunition or colored lights	TM 5-280	Foreign Mine Warfare Equipment, April 1965
Light Blue	Practice ammunition. Presence of high or low explosive components indicated by yellow or brown band	TM 5-280	Foreign Mine Warfare Equipment, July 1971
Orange	Ammunition used for tracking and recovery in tests or in training operations	TM 9-1985-2 TM 9-1985-3	French Grenades and Grenade Fuzes Ministry of War, 15 Dec 1930 German Explosive Ordnance, 1953 German Explosive Ordnance, 1953
Bronze	Dummy and training ammunition	PATR 2510 PATR 2145	German Explosives, 1958 Russian Explosives, 1955
<i>List of a Few of the Publications Which Contain Additional Information on the Identification of Ammunition and Explosive Devices</i>			
OP2216	Aircraft Bombs, Fuzes & Associated Components		German Intelligence Data Sheets on World War I Chemical Ammunition British, French, Italian, Russian, 1918
26/Manuals/1473	Ammunition Handbook for the Royal Army Service Corps 1936	H.Dv. 454/6b	Geschosszünder Beschreibungen und Zeichnungen, July 3, 1938—Berlin, 1938

- OPNAV 30-3M Handbook of Japanese Explosive Ordnance, 15 August 1945
- Kemp D&PS Handbook of German Aircraft Ammunition by Bross & D&PS Aberdeen PG, Md, 1956
Handbook of Enemy Ammunition Pamphlets, The War Office 1940 thru 1945, London
- N 3353 Istruzione Provvisoria Sulle Bombe A Mano S.R.C.M. Breda—O.T.O. od 35, Roma 1938
- No 647 Istruzione Sulle Munizioni, Parte I, Roma 1936
- TM 9-1985-6 Italian & French Explosive Ordnance, 1953
- TM 9-1985-4 Japanese Explosive Ordnance, 1953
- TM 9-1985-5 Japanese Explosive Ordnance, 1953
L'Artificiere D'Artiglieria, Caricamento Proiettili, 2nd Edition, 1936
L'Artificiere D'Artiglieria, 3rd Edition, 1941
Les Fusées Paris, 1918
Manuel Des Munitions—Imprimerie Nationale, 1932
- AOP-2 Method of Application of the NATO Code of Colours for the Identification of Ammunition (except Ammunition of a Calibre Below 20mm). Prepared by the Department of National Defence, Canada Ottawa 1966
- TM 9-1981 Military Pyrotechnics, 1943
- TM 9-1981 Military Pyrotechnics, 1951
- MIL-STD-709 Military Standard Ammunition Color Coding, 27 June 1960
- MIL-STD-709B Military Standard Ammunition Color Coding, 13 October 1972
- R. Moh C.3 Normas para el pintado y marcado de la munición de combate, ejercicio e instrucción, Buenos Aires 1959
- Bulletins 216-R2 & 287 Notes on Ammunition by Maj Wm. C. Foote, C.A. Coast Artillery School, Fort Monroe, Va, Oct 31, 1918
- SS 420 Notes on German Shells (second edition) General Staff (Intelligence) General Headquarters, 1 May 1918
- D 460/9+ Ringbuck für Zünder, Band II, 5 June 1941
- D 460/8+ Ringbuck für Zünder, Band I, 5 June 1941
Ordnance Magazine, Various Editions, American Ordnance Association, Washington, DC
Rockets, 1958
- TM 9-1950 FSTC-CW-07-02-66 Small Arms Ammunition Identification Guide, December 1966
The Bombardier & Pocket Gunner by Ralph Willett Adye London 1803
Treatise on Ammunition, 6th Edition, War Office, London, 1897
Treatise on Ammunition 10th Edition, War Office, London, 1915
Various German drawings of projectiles and fuzes 1939-1945
- C.W.S. Intelligence Summary No 12 Markings of Japanese Chemical Warfare Munitions
Written by John F.W. Pflueger
- Iditol.** A synthetic resin obtained by the condensation of phenol & formaldehyde. It is used as a binder in many Russian pyrotechnics
Ref: Gorst (1957), 162
- Ievler (or Jewler) Explosives.** Various Sprengel-type explosive mixtures proposed in 1897-1900 by Ievler of Russia, such as Prométhées. Other explosives of this class consisted of liquids such as nitrobenzene, methanol etc absorbed on potassium chlorate mixed with Portland cement and/or copper oxide etc
Ref: Daniel (1902), 328
- Igdanit.** A Russian explosive similar to ANFO. It consists of a mixture of AN and 5 to 8% fuel oil. It is usually mixed just prior to use. Max deton velocity is only 2000 m/sec for mixes with 5 to 6% oil (*Ref*)
See IGNADITY in Vol 5, pp D1744-R to D1746-L

Ref: E.P. Maksimova, *Vzryvchatyie Veshchestva Prosteishego Sostava, Inst Gornago Dela, Akad Nauk SSR, Sbornik Statei i Materialov 1960, 34-41 & CA 57, 7963 (1962) & Explosivst 1964, 20*

Igelit. Trade name for a polyvinyl plastic used as a binder in some Ger pyro compns, such as listed in PATR 2510 (1958), p Ger 154-R

Igloo Magazines. This type of magazine is now standard for storing ammunition of the US Armed Forces because it permits considerable saving in space over other types of magazines. An Igloo is a concrete building of semi-cylindrical shape with the axis on the ground and with earth covering the arched roof and piled up against the sides. This earth acts as a barricade and also serves to conceal the Igloo as much as possible from view

The usual sizes of igloos are: 26'6" x 60'8" and 13' to the highest part of the roof, or 36' x 62' and 11'6" to the highest part of the roof

Usually igloos are built in groups of seven, so arranged that one is in the center and six others around it as on the corners of a hexagon (Ref 1). Each igloo holds 143,000 lbs of explosives, making a total for the group of one million pounds. With this arrangement, a 7-igloo group occupies a circle of 1000 ft diameter with about 1,920 ft between the nearest buildings of adjacent igloo groups, and occupies only about 33% of the space required by older types of magazines for the same amount of explosives

According to Hall (Ref 2), the usual 800 feet, which has been prescribed as intermagazine distance for unbarricaded surface magazines containing 250,000 lbs of explosives, may be reduced to as low as 185 feet in the case of igloos or underground magazines

Refs: 1) G.L. Schuyler, US Naval Inst Proceedings, 56, No 323, pp 31-32 (Jan 1930) 2) D.C. Hall, Army Ordnance, 33, No 169, p 46 (1948) 3) US Army, AMC Regulation AMCR 385-100 (April 1970), "Safety Manual," pp 8-16, 17-6, 17-16 & 17-32

Ignis Volatilis. (Flying Fire) (Feu volant in French). A kind of Greek fire used militarily,

somewhat like an incendiary missile. Marco Greco in his 9th to 10th century book entitled: "Liber Ignium ad Comburendos Hostes" gives the composition as: sulfur 1 part, charcoal (of linden, or willow trees) 2 parts, saltpeter (crude) 6 parts

Ref: Daniel (1902), 382

Ignitacord. Thermalite Ignitacord is the Dupont Inc name for a device for igniting safety fuse. It is cordlike in appearance and burns progressively along its length with an external flame at the zone of burning. The flame is short and quite hot, and offers a means of lighting a series of safety fuses in the desired rotation with the lighting time at the face being no greater than that necessary to light one fuse

The product is available in two burning speeds: namely, Type A Cord burning at the approximate rate of 8 to 10 seconds per foot, and Type B Cord burning at approximately 16 to 20 seconds per foot. Type A Cord is intended for use in stoping rounds where the blasts may contain a large number of holes or where the holes are normally collared from 2 to 4 feet apart. Type B Cord is better suited for use in heading or development rounds where the holes may be collared much closer together.

Both types of cord are clearly marked at one foot intervals so that the fuses may be easily spaced to insure positive rotation. Metal connectors are available for connecting safety fuse to the cord. These connectors are crimped to the safety fuse at the same time that the caps are crimped, and are so constructed that they protect the end of the safety fuse from moisture. They contain a small pressed charge of an ignition compound which lights the fuse when the cord burns through the connector

Ignitacord is subject to ignition by open flame, sparks, friction or a sharp blow. The connectors can be ignited by heavy impact, as, for example, from falling rocks. Ignitacord must not be used as a substitute for safety fuse, or in any place where an open flame is prohibited *Ref:* Blasters' Handbook (1958), pp 100 & 225-27

IGNITERS

Igniter. Any device serving to ignite either explosives, propellants or pyrotechnic compo-

sitions, may be called an igniter. The following igniters may be listed: safety fuse, for ignition of Black Powder and blasting caps; igniter pad, for ignition of propellants in cannon; electric igniters, quick and slow matches, quills, squibs, miner's squib igniter fuse, igniters for pyrotechnic compositions, igniters for rockets, igniters for tracers, etc. All of these devices are briefly described under their individual headings

Igniter Bag or Pad. Separate-loaded ammunition used in cannon of larger caliber, consists of a propellant charge loaded in cotton or rayon (formerly silk) bags, which are loaded directly behind the projectile in the breach of the gun. At the base of the bags, a flat pad in the shape of a disc (igniter pad or bag) made of closely-woven cloth and filled with Black Powder, is sewn or laced. The charge of this bag is ignited by means of a primer located in the breach behind the powder and then the flame is transmitted to the propellant charge (smokeless powder)

Sometimes, in addition to the igniter bag, a charge of Black Powder running through the propellant in the form of a "core" is also used *Refs:* 1) Hayes (1938), pp 34-35 2) Ohart (1946), pp 184 & 189 3) Also see Sect 3, Part D of Vol 4, pp D795-97

Igniter Bag (Used in Rockets). A flat bag filled with Black Powder and placed near the propellant about the middle of the rocket motor. This serves as an auxiliary igniter to the main one (see Rocket Igniter), which is placed in the throat of the nozzle. For more information, see Ohart, (1946), p 334 or books on rockets

Igniter Composition. See Ignition Composition

Igniter Cord. Called **Pyrocore** and developed by the duPont Co, it consists of a small continuous metal tubing containing a detonating (HE) ignition core. The core is flame sensitive and promotes ignition at the speed of detonation. Upon functioning, the "Pyrocore" produces high-velocity hot metal particles capable of igniting a variety of igniter and propellant compositions. One use of this device is in combustible cartridge ammunition (see Vol 2, p C79, Ref 25), where instantaneous ignition is required

Ref: duPont Co's advertisement in *Ordn* 50, No 276, 583 (1966)

Igniter Cord. Extruded incendiary cords of thermoplastic consistency are prepared by combining powder oxidizing and reducing agents in a plastic binder. Thus, 33 parts plasticized nitrocellulose (I) (consisting of high-N, low-viscosity nitrocotton 50, di-Bu phthalate 48, Ph_2NH 2, and citric acid 2 parts) was heated in a Werner-Pfeiderer mixer with 66 parts Si (specific surface 38,000 sq cm/cc) and 1 part $\text{N,N}'$ -diethylcarbanilide (II). Another mixt contg I 14, Pb_3O_4 60.6, KClO_4 24.7, and II 0.7 parts was prepared separately. The 2 mixts were rolled into sheets, diced to 3/16-in cubes, and fed to a screw extruder in a 1:3 ratio. After extrusion at 100° to a diam of 0.065 in, the threads were coated with a 0.004-in polyethylene film, giving a product with a burning speed of 36 sec/yard. I can be replaced by a 60:40 mixt of polystyrene (mol wt 80,000) with di-Bu phthalate or a 40:60 mixt of poly(methyl methacrylate) with di-Bu phthalate *Ref:* K. J. Brimley, *BritP* 787411 (1956) & *CA* 52, 7704 (1958)

Igniter Core. See Igniter Bag

Igniters, Delay, Electric. Devices used for igniting Black Powder charges. They consist of copper, other metal or plastic tubes provided with an ignition mixture (which can also be Black Powder) in which is embedded a piece of resistance wire (bridge), with two leads attached, similar to electric blasting caps. Pieces of safety fuse of various lengths, to provide different delays, may be attached to the closed end of tube, and the loose ends of the fuses are then dipped in wax for waterproofing

When ready for firing, a small section of the fuse is cut away at the waxed end (to expose a clean surface) and imbedded in the main Black Powder charge to be used in the blast. When an electric current is passed through the bridge wire, the wire is heated to incandescence and ignites the flash powder in the igniter. The ignited powder burns with sufficient intensity to rupture the Cu tube, igniting the fuse (attached to it), which communicates the fire to the main charge of Black Powder. See also Sect 1, Part A in Vol 4, pp D733-34

Igniters, Electric. Devices intended for firing explosives of the Black Powder type, primarily in commercial blasting. Their construction is similar to that of electric blasting caps except that the capsules (tubes, shells) can be made of wood, paper, cardboard, plastic, etc instead of metal, such as Al, Cu, gilding metal or German silver. As a filler, these caps usually contained an igniting compound, such as mealed powder mixed with guncotton, or other flash mixtures, packed around the bridge wire. See also description of Squibs in this section
Ref: Marshall 2, (1917), 545

Igniters for Firearms. (Historical) See Sect 2, Part C in Vol 4, pp D753-756

Igniters for Fuses. Devices for igniting a safety fuse, which then explodes a blasting cap which in turn explodes the main charge, may be divided into the ones intended for use in blasting operations where an open flame or a spark is of no danger (such as quarries, non-gaseous mines, etc) and those for use in gassy or dusty-coal mines, where no open flame or spark should be allowed. The last named igniters may be called *safety igniters* (allumeurs de sûreté, in French)
Open Flame Igniters

Amadou or tinder igniter is the oldest of these devices, in which the heat produced by a glowing tinder was utilized to ignite the core of a fuse. The tinder itself was ignited by means of sparks produced on striking flint with steel

Wick igniter utilized the heat produced by a slowly burning special wick, which was ignited by flint-steel, as above

Ordinary matches are most frequently used at the present time, but they are not satisfactory in wind or rain. Neither is it convenient to use them for lighting a number of fuses trimmed to fire in rotation because these must be lighted quickly, surely and in a specified order (Ref 4)

In order to get better results when using ordinary matches, the free end of the fuse is slit open (about 1/4" lengthwise) and the head of a match is inserted in this slit so that it touches the core of the fuse. After this, the head is lighted by another ordinary match; by this means the fuse is ignited more readily than by a single match

Safety fuse match lighter consists of a paper tube 1/4" long and of the same diameter as the fuse. One end of the tube is closed and coated with the same composition as Swedish (safety) matches. The open end of the tube is slipped over the freshly cut end of a fuse so that the match composition is against the end of the fuse. By striking the match end of the tube against the coated side of a safety-match box, the match is ignited and this in turn ignites the fuse. The match end of the tube can also be ignited with an ordinary match (Ref 4)

The *lead spitter, pull-wire & hot wire fuse lighters* are described in Sect 1, Part A of Vol 4, p D733

Closed Flame or Safety Igniters

A device invented by *Lagot* (1881), consisting of a tube filled with pieces of charcoal impregnated with a compound (such as nitrate) which permits the charcoal to burn in absence of air and without producing flame. The tube has an opening just large enough for the insertion of the end of a fuse to be ignited (Ref 1)

Master fuse lighter consists of a waterproof fiber shell covered with flexible rubber sheeting. A charge of ignition composition is placed in the base of the shell and a freshly cut "pilot fuse" and six fuses leading to boreholes are inserted through the rubber covering. The pilot fuse is ignited from the outside and it ignites the ignition composition inside the shell which then simultaneously ignites the other fuses

The use of this lighter insures better results in rotation firing and allows more time for the blaster to retire before the detonation of the first charge, since he has only the pilot fuse to light. The use of this type of fuse has the disadvantage of requiring large amounts of fuse (Ref 4)

Heath and Frost proposed a modification of the miner's safety lamp so that it was possible to use it to heat a small piece of iron to incandescence which could then be touched to the open end of a fuse. This operation was done in such a manner that no flame or spark was produced outside the enclosure of the lamp (Ref 1)

Bickford's Collier Safety Lighter, invented in 1889, consists of a tube (tinned-iron or steel) closed at one end and containing a mixture of $KClO_3$ and sugar, pressed into a pellet not

exceeding 100mg in weight. This is placed in close contact with a hermetically sealed glass capsule containing concd H_2SO_4 . A length of specially prep'd and waterproofed safety fuse is fitted into the open end of the tube, the joint being cemented with tape to form a closed chamber. By squeezing the tube with pliers, the glass ampule is broken. This brings the H_2SO_4 into contact with $KClO_3$ + sugar, ignites the mixture which in turn ignites the fuse (Refs 1 & 2)

This device may be considered as a modification and improvement of the devices proposed by Roth and by Zschokke. In the latter, a glass capsule containing H_2SO_4 was wrapped in a piece of cloth impregnated with a concentrated solution of $KClO_3$ + sugar (Ref 1)

Mortier used a small piece of metallic sodium coming in contact with a drop of water to ignite fuses (Ref 1)

Muller, about 1880, invented a device which was essentially as follows: the cut end of a fuse was inserted into a tightly-fitting priming cap, which in turn was placed inside a special, hermetically sealed pistol. The cap was fired when struck by the pistol firing pin and this ignited the fuse. The flame produced by the priming cap remained inside the pistol (Ref 1)

A similar device was proposed by Hohendahl in 1896

The *Miner's safety match* was patented by *Pope* and manufactured during the latter part of the 19th century by William Bennett Sons & Co of Camborne, England. It consisted of a slightly tapered metallic tube, the narrow end of which was closed. A small quantity of priming composition was placed inside the tube and then a tightly fitting fuse was inserted so that the open end of the fuse touched the priming composition. By rubbing the closed end of the tube against a surface covered with a friction compound, sufficient heat was produced to ignite the priming composition inside the tube and that, in turn, ignited the fuse (Ref 1)

A device invented by *Meinhard* consisted of a metallic tube, 20cm in length, closed at one end. Inside the tube was placed a small quantity of priming explosive and on top of it the fuse was inserted so that it fitted tightly

On striking the end containing the priming mixture with a hammer, or other object, ignition of the priming mixture as well as of the

fuse was achieved (Ref 1)

Hargreaves patented a device in which the fuse was ignited by friction (Ref 3)

Most of the devices described above are no longer used and are only of historical interest

Today, in gassy mines in the US, the explosive cartridges are detonated directly with electric blasting caps (Refs 4 & 5), without the use of safety fuse

However, safety fuses are still used in some non-gassy mines, in agricultural blasting, etc
 Refs: 1) Daniel (1902), pp 10-14 (under "Allumeurs") 2) Marshall, 2, pp 537-9 (1917) 3) A. F. Hargreaves, BritP 13880 (1913) 4) DuPont, Blasters' Handbook (1950), pp 80-81 and 92-94 5) Olin Industries Inc, Explosive Products, 2nd ed, p 38 6) DuPont, Blasters' Handbook (1958), pp 97-102 & (1969), pp 98-102

Igniter Pad. See Igniter Bag

Igniters for Propellants. Devices acting as intermediates between priming charges and propellant charges and serving to produce a flame larger than the one produced by a priming cap

In small arms cartridges, where the propellant grains are of small dimensions and the charge itself is small, proper ignition may be achieved by a primer cap without introducing any auxiliary device, such as an igniter

On the other hand, in guns, where the propellant charge and the grain size of the powder are both large, it is impossible to achieve proper ignition unless either the size of the primer is increased considerably or an intermediate charge of easily ignitable material is introduced. Of these two methods, the former is undesirable because the use of large primers is not only dangerous but is also much more expensive. Thus it is the latter method that is commonly employed, provided a proper substance is used in the igniters. The usual propellant igniter is Black Powder because it is easier to ignite than smokeless powder and because it produces a large flame of uniform intensity independent of the pressure developed in the barrel of the gun

Igniters used for separate loaded ammunition of larger caliber cannons are called "Igniter Bags" and were described above. Igniters used in fixed ammunition of cannons of medium and small caliber consist of a long, narrow, per-

forated tube filled with grains of Black Powder, closed at one end and attached to the percussion primer at the other end. The tube penetrates the propellant charge to as much as $3/4$ the length of the cartridge. In this arrangement, the percussion primer is struck by a blow of a firing pin. This sets the priming charge afire, which then ignites the Black Powder in the perforated tube. The flame of burning Black Powder shoots through the perforations and ignites large areas of the propellant powder, insuring proper propulsive action. When the igniter and percussion primer are assembled as one unit, the ensemble is called a *combination primer*, or *primer-igniter*. The function & location of *primer-igniters* in *artillery ammunition* is described in Sec 3, Part D in Vol 4, pp D777-803

Igniter, Pyrotechnics. Any device used for igniting pyrotechnic compositions, such as illuminating, smoke, tracer, flare, photoflash mixtures, etc may be called "pyrotechnic igniter" and the compositions used in such igniters are called "igniting mixtures" or "igniting charges"

Igniter, Rocket. There are generally two igniters in a rocket motor, the main and auxiliary. The main igniter consists of a primer and a charge of Black Powder, or other igniting mixture, contained in a plastic body (generally ethyl cellulose) and placed in the throat of the nozzle of the motor. The primer is fired by the heat generated in a wire by means of electric current, thus igniting the Black Powder of the igniter, which in turn ignites the propelling charge, usually consisting of grains of double-base powder (Ref 1, p 333-34)

In addition to the main igniter, there is an auxiliary one, described under *Igniter Bag for Rockets*

Igniter Squibs. The squibs are essentially electric detonators except that they produce a flash & not an explosion. The commercial type squib, which is also used for military purposes, consists of an aluminum shell $7/8$ to $1-1/2$ " long with the flash charge in the bottom of the closed end. It contains an electrical firing element in the form of a bridge wire and two lead wires sealed in the other end with waterproofing compound or a deformable plug that is crimped into the open end of the shell. About 0.5 ampere is required to fire the squib; when the current is passed through the bridge wire,

it is heated to incandescence and ignites the flash powder. The ignited powder burns with sufficient intensity to rupture the Al shell and the flash thus produced ignites the next element in the train, which can be either a Black-Powder charge, a slow-burning fuse or a flash-initiated detonator (Refs 1 & 2)

Electric squibs will ignite pelleted Black Powder which is too wet to be fired with a safety fuse. In blasting operations they permit tight tamping of the bore hole, the ignition of the powder charge at any desired point, the firing of a number of shots at the same time and definite control of the time of firing the charge. Electric squibs are considered the safest and most effective means of firing black blasting or pellet powder (Ref 3)

Electric squibs may also be of the delay type, varying in length from $3-1/8$ to $5-1/8$ ", depending on the delay time (Ref 1)

Refs: 1) Ohart (1946), p 59 2) Olin Industries, Inc, "Explosives Products," Pamphlet, 2nd edition, p 38 3) DuPont Blasters' Handbook (1949), p 80

Igniter Tests. Assembled electric igniters intended for military use are usually subjected to the following tests, after selecting 10 samples for each test:

1) *Material and Workmanship.* All materials shall be of high grade and all parts free from chips, dirt, grease and other foreign matter. The seal between the two wires and the cup, tube, etc shall be continuous. If the seal is questionable, it is subjected to a pneumatic test by introducing an internal air pressure of 4 psi, held for 3 seconds

2) *Continuity of Circuit and Resistance* is to be determined by means of a Wheatstone bridge

3) *Waterproofness (Water Submersion Test).* Ten igniters are kept under water for 18 to 48 hours (depending on specification requirements) at $70-75^{\circ}\text{F}$ and then fired immediately

4) *Current and Functioning.* The terminals of each of 10 igniters shall be connected, one at a time, in series with an ammeter, a rheostat and a source of direct current (new dry cell). Move the rheostat until the igniter is fired and note the current (amperes) required for it. Note also if the igniters function properly on firing; the metallic (or plastic) shell should be ruptured

but the sealing plug should not be blown out
Note: Sometimes, requirements call for conditioning the igniters at high temperatures, say 150°, for 1 hour before firing

5) *Ignition Delay.* If the igniter is of the delay type, it is necessary to determine the time elapsed from the start of current flow to the rupture of the igniter case. For instance, the M12 electric igniter has an ignition delay not exceeding 100 milliseconds (Ref 2)

6) *Detailed Examination of Parts.* Sometimes it is necessary to take the igniter apart and submit the shell (metal or plastic), the wires, sealing compound and igniter compound to a physical and chemical examination. The disassembly operation should be carried out behind a barricade, preferably by remote control. The tests are usually different for each type of igniter and are described in the corresponding specifications

Refs: 1) US Army Spec 50-49-1 2) US Army Spec 50-49-2 3) US Army Spec 50-12-14B 4) US Army Spec 50-78-7

Igniters for Tracers and their Compositions

Ignitor compositions for Tracers are designed to be nearly gasless and to have low ignition temps. Some of these compositions are described in Vol 4, Sect 3, Part C, p D774. They are usually pressed into a cavity at the rear portion of a projectile after first loading most of this cavity with a tracer composition. See Fig 30 in Vol 4, p D744

A tracer composition difficult to ignite consists of Sr(NO₃)₂ 65, Mg (powder) 30 and binder 5

This composition has to be ignited by a compound which develops an extremely high temperature, such as BaO₂ 78, magnesium powder 20 and calcium resinate 2%. Unfortunately, this composition develops a very bright light which might blind the gunners during night firing. In order to avoid this possibility, an additional charge, consisting of BaO₂ 78, manganese powder 20 and calcium resinate 2, is placed on top of the above composition. This mixture is easily ignited, but it does not burn with as hot or bright a flame as the magnesium mixture. In this kind of loading, the manganese mixture is called the "igniter mixture," while the magnesium mixture is called the "Subigniter mixture" or "Subigniter"

During WWI, in the so-called "*perforated luminous ball cartridges*," fired from airplane machine guns, the Germans used two charges, besides the propelling charge: an *illuminating charge* consisting of Mg 64.7, Sr(NO₃)₂ 19.3, Ca(OH)₂ 11.7 and resinous matter 4.3%; and above it, an *igniter charge* consisting of KMnO₄ 54.9 and iron powder 45.1% (Ref 3, v I, p 192)

During WWII, the Germans developed two types of igniter mixtures:

- a) Barium peroxide + metallic magnesium + binder;
- b) Barium nitrate + metallic magnesium + binder (some compositions also contained Styphnic Acid)

The barium peroxide mixtures were similar to the American "Igniter K"

Examples of type a):

1) BaO₂ 78.4, Mg 19.1, binder 2.5%. A quantity equal to 0.67g was used in each 20mm HE self-destroying projectile

2) BaO₂ 75.0, Mg 22.0, binder 3.0%. A quantity equal to 0.30g was used for each 37mm APHV shell

3) BaO₂ 69.7, BaCO₃ 13.5, Mg 14.2, binder 2.6%. A quantity equal to 3.0g was used for each 88mm AP shell

Examples of type b):

1) Ba(NO₃)₂ 32.7, Mg 36.7, Na Picrate 11.9, binder 18.7%. A quantity equal to 0.30g was used for each 20mm APHV shell

2) Ba(NO₃)₂ 41.7, Mg 30.0, Sr Picrate 12.8, binder 15.5%. A quantity equal to 0.20g was used for each 50mm APHV short-case shell

Heiskell claims a tracer unit for a projectile, suitable for improving daylight visibility & having a non-flash slow-burning compn which delays ignition of the tracer compn for a predetermined time (Ref 5)

One of the *Italian* igniter compositions contained BaO₂ 75.0, Mg 23.0, binder 2.0% and 0.9g was used for each 47mm AP Round Nose Shell (Ref 2)

One of the *Russian* igniter compounds contained BaO₂ 60.0, Mg 13.6, binder (resin) 26.4%; 0.65g was used for each 76mm APHE shell (Ref 2)

Refs: 1) Faber (1919), vols 1 & 2 2) D. Hart, PATR 1335, 6 (Sept 1943) 3) "Data on American & Foreign Explosives," PB 11544 (1944) 4) Ohart (1946), pp 61-63 & 77 5) R.H. Heiskell, USP 2899291 & CA 53, 19391 (1958)

IGNITION

Ignition is the act of kindling or setting on fire any combustible substance. High explosives as well as Black Powder, Nitrocellulose, smokeless powder and pyrotechnic compositions can undergo ignition (burn) without detonating.

The consequences of ignition, ie burning or combustion, are described under "Burning & Combustion" in Vol 2, pp B343-B357, under "Combustion" in Vol 3, pp C425-C433 and "Detonation-Development from Burning or Deflagration" in Vol 4, pp D245-D252. For further discussion of the ignition of explosives, the reader is referred to *High Explosives, Hot Spots, Hypergolic Propellants & Initiation Mechanisms* in this Vol and to *Thermal Explosions* in Vol 9. Some discussion of Ignition, Igniters etc is also presented under *Detonators, Igniters & Primers* in Vol 4, pp D757-D807.

For convenience, we will divide the subject of *Ignition* into the following sections which treat different aspects of the general problem: 1) Elementary Theory of Ignition 2) Ignition Cartridge 3) Ignition Compositions for use with Pyrotechnics 5) Ignition of Firedamp & Coal Dust 6) Ignition-Spontaneous 7) Ignition, Test for 8) Ignition Theory of Explosives

1) Elementary Theory of Ignition

Introduction

A highly simplified diagrammatic representation of ignition is shown in the following sketch

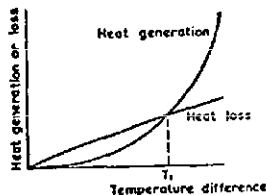

Since heat loss varies essentially linearly with temperature difference, it predominates at small temp differences. Above some temp T_1 , heat generation which varies exponentially with temp difference becomes larger than heat loss. In this sketch T_1 can be considered to be the *ignition temperature* of the system, although, more accurately, $T_1 = \text{ign temp} - \text{initial temp}$.

This simple model represents most of the situations of interest for explosives & propellants. For dust and gas explosions, however, heat generation, ie reaction rate, may be controlled by the availability of oxygen at the reaction

site. Such reactions are said to be diffusion-controlled.

Combustible systems can be ignited by sparks, hot wires, flames, hot particles, heated surfaces and many other sources. Ignition by sparks & hot wires are of particular interest in connection with explosives and we will therefore consider them in more detail below.

Ignition by Sparks. (See also Electricity, Extraneous and Hazards Associated with it in Vol 5, pp E36-E46). In spark ignition the duration of stimulus energy is very short. It is possible to pass small electric sparks through an explosive gas or explosive dust cloud without producing ignition. When the spark energy is increased, a threshold energy is eventually obtained at which the spark becomes incendiary, in the sense that a combustion wave propagates from the spark through the volume of gas. This minimum ignition energy is a function of experimental variables such as the parameters of the explosive gas and the configuration of the spark gap.

A versatile apparatus for determining minimum energies for electric-spark ignition of gases and dust clouds, developed by Blanc et al (Ref 1), is shown below.

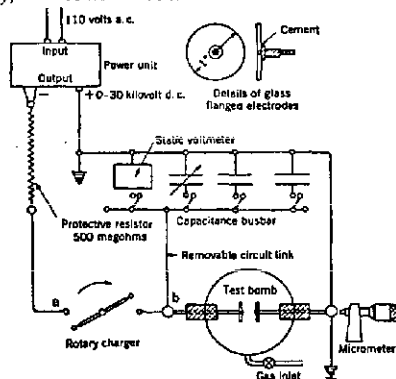

Many data have been obtained with this & similar apparatus (see Ref 7).

Lewis & Von Elbe (Ref 7), in discussing the theoretical aspects of spark ignition, start with the supposition that a spark instantly establishes a small volume of gas within which the temperature is very high. The temperature within the spark volume decreases rapidly due to the flow of heat to the ambient unburned gas. In the adjacent layer of ambient gas the temperature rises and induces chemical reaction, so that a combustion wave is formed which propagates

outward with approximately spherical symmetry. Whether the wave develops to the steady state depends on the size to which the inflated volume has grown at the time when the temperature at the origin has decreased to the order of the normal flame temperature. In order to continue to propagate, the flame should at that time have grown to at least such size that the temperature gradient between the burned gas in the core and the outer unburned gas has approximately the same slope as the temperature gradient in the steady-state wave. If the size is too small, viz, if the gradient is too steep, the rate of heat liberation within the inner more or less spherical zone of chemical reaction is insufficient to compensate for the rate of heat loss to the outer zone of preheated unburned gas. In that case the loss of heat to the unburned gas continuously exceeds the gain of heat by chemical reaction, so that the temperature decreases throughout the reacting volume, the reaction gradually ceases, and the combustion wave becomes extinct after only a small amount of gas around the original spark has burned.

Quantitative development of the above model of the ignition process is overwhelmingly complicated. Lewis & Von Elbe therefore chose to attempt correlation of experimental minimum ignition energies with some energy functions computed from minimal flame parameters.

One such energy value, denoted by H' , is obtained by computing the sensible heat in a sphere of diameter d , assuming that the content of the sphere is completely burned so that its temperature is T_b and its density is ρ_b . The heat contained in the sphere in excess of the heat at the initial temperature T_u is obtained from the equation

$$H' = \frac{\pi}{6} d^3 c_p \rho_b (T_b - T_u)$$

Another energy value which they use is denoted by H'' and is given by the equation

$$H'' = \pi d^2 \frac{k}{S_u} (T_b - T_u)$$

Further development of their model is summarized in their diagram of a minimal flame shown below

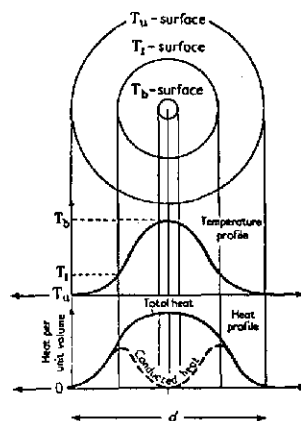

Note that the temperature profile differs from the total heat profile because the heat per unit volume depends not only on the local temperature but also on the local density of the flame gas. In the preheat zone the profile of conducted heat coincides with the profile of total heat, whereas in the reaction zone the conducted heat gradually drops to zero. The difference between total heat and conducted heat represents the heat gained by chemical reaction. The volume integral of the total heat is approximately H' , and the volume integral of the conducted heat is approximately H'' .

This model is claimed to agree with experiment in that experimentally determined minimum energies are smaller than either H' or H'' , and generally, but not always, $H' > H''$. For details, the reader is referred to Ref 7.

Ignition of gases resulting in detonation is treated in Vol 4, pp D732-32 under "Detonative Combustion" & "Detonative Ignition of Gases" and also under "Detonation (and Deflagration) in Gases" and "Detonation of Gases" etc; "Development from Burning" etc, pp D360-63. More recent developments in the study of DDT (Deflagration-to-Detonation Transition) will be described under Transition to Detonation.

Ignition by Hot Wires. Now we turn to a discussion of ignition by hot wires, but we purposely exclude studies on EED's (See Vol 5, pp E63-E68) or initiation of detonation by hot wires (See Initiation, Hot Wire in this Vol). We quote Lewis & Von Elbe:

"Electric sparks are very hot and fast-acting ignition sources. Because the discharge time of an electric spark is very short (of the order of 10^{-8} to 10^{-7} second), the energy that is imparted to the gas at the end of the discharge period is highly concentrated, so that a very steep temperature profile with a very high temperature at the center is established. In this initial stage of flame development the chemical heat liberation is insufficient to maintain such steep temperature profile, so that the profile broadens and the temperature at the center decreases. Within a period of time which depends on the physical and chemical properties of the gas, and provided that the discharge energy is sufficient, the profile develops to the profile of the minimal flame and thence continues to propagate as a steady-state wave, while the temperature in the center settles down to approximately the value of the flame temperature

"If the same amount of source energy were delivered by, say, an electric current over a time larger than the time of development of a minimal flame, the temperature at the core would drop below the flame temperature, the heat liberation in the reaction zone would not attain a balance with the outflow of heat into the preheat zone, and the flame would become extinct. On the other hand, if the current flow were continued for a longer period, the temperature profile ultimately would become sufficiently broad, and the temperature in the core sufficiently high, so that heat liberation within the reaction zone overbalances the outflow of heat and ignition occurs

"We single out three interdependent quantities which characterize the ignition threshold of a slow source such as described. One is the total heating time (the time during which the current flows) which we shall call the critical heating period. Another is the total energy delivered during this time, which we shall call the critical source energy, and which defines the current strength. A third is the temperature T_C in the core at the end of the heating period, which we shall call the critical source temperature. The general form of relation between these three quantities is shown schematically in Fig 168. Thus, the minimum ignition energy, which is denoted of the symbol h_C , corresponds to a very short ("zero") value of the critical heating

period. The corresponding critical source temperature has a value smaller than the flame temperature T_b . As the critical heating period is increased (and the current strength correspondingly decreased) the critical source temperature decreases and the critical source energy increases. In terms of unit increase of critical heating period, these changes are initially large, as indicated in the figure, and gradually become smaller. The temperature curve finally becomes quite flat; this corresponds to the rule, which is inherent in Arrhenius' law, that at low temperatures a few degrees of temperature change produce large changes in the rate of the chemical reaction. In the present system this means that at low values of the critical source temperature a few degrees of temperature change in the reacting core of the heated volume change the rate of heat liberation very greatly. Hence, relatively large changes of critical source energy, viz, critical heating period, which correspond to large changes of the reaction rate at the ignition threshold, produce only small changes of critical source temperature"

Figure 168 is an idealization because it does not take into account the energy required to heat the source, ie the wire, to some critical temperature. This critical temperature should be close to that of the flat portion of the lower curve of Fig 168. If one assumes that the critical wire temperature remains constant in any given ignition system, and allows for heat losses by the wire:

$$E = A + Bt \quad (1)$$

where A is the minimum critical energy for ignition and B is the combined rate of heat loss from the wire to its soldered ends & to the medium in which the wire is imbedded.

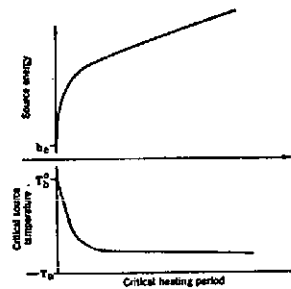

Fig. 168. Source energies and critical source temperatures versus critical heating period. Schematic illustration

Figure 1 shows Jones' results (Ref 3) of his study of critical firing energies for electric fuse-heads (also known as matchheads). The data in Fig 1 are for an 80/20 LMNR/ KClO_3 ignition mixture (LMNR is Lead Mononitroresorcinate).

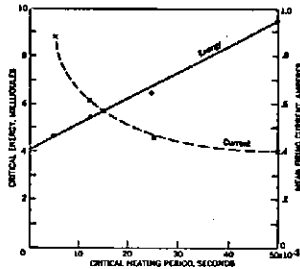
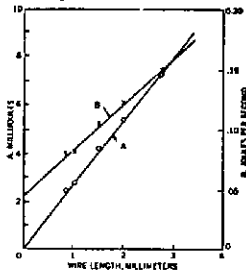

Fig 1. Relation between ignition energy, mean firing current, and critical heating period

The energy plot certainly agrees with the requirements of Eq (1). Now it would be expected that both A & B of Eq (1) would increase with wire length. That it is so is shown below (this Fig is also taken from Ref 3)



We may therefore write

$$A = Gl \quad (2)$$

where l is the wire length and G the minimum critical energy per unit length. Further,

$$B = H + Jl \quad (3)$$

where H is the rate of heat loss to the wire ends and J the rate of heat flow from the wire to the medium per unit length of wire. The corresponding amount of heat absorbed by the medium per unit wire length is Jt . This does not represent the total heat absorbed by the medium, but rather the excess over the heat absorbed when the critical energy for ignition is a minimum, ie when $t=0$

It should thus be possible to divide the term G into two parts—one representing the heat per unit wire length which is imparted to the explosive medium when the critical energy is a minimum, and the other representing the heat

content of the wire per unit length. The second part should be equal to the product $(T_c - T_u)ca$, where T_c and T_u are the critical and the ambient temperature, c is the heat capacity per unit volume of wire material, and a is the cross-sectional area of the wire; it should therefore vanish when the wire diameter is made vanishingly small. The first part should not vanish

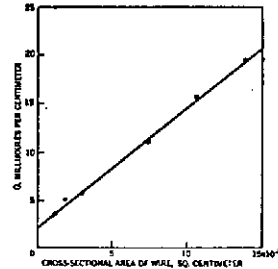

Fig 2. Relation between cross-sectional area of wire and $G=A/l$ (l =wire length) (Ref 3) with wire diameter. The term G should therefore be of the form

$$G = K + La \quad (4)$$

where K is that part of the minimum critical energy per unit length of wire which is absorbed by the medium, and $L = (T_c - T_u)c$ is the heat content per unit volume of the wire at the critical temperature. Figure 2 shows values of G obtained by Jones for wires of various diameters. Each point is the minimum critical energy per unit length of wire for zero critical heating period and for a given wire diameter. It is seen that the plot of the experimental points versus the cross-sectional area yields a curve which is virtually a straight line. Thus, it would seem that K is determined by the point of intersection of the line with the G axis, and L by the slope. This suggestion should be treated with some caution because K , though not vanishing with wire diameter, nevertheless is certainly a function of the diameter. However, the error introduced by considering K as constant is not large

The results of Jones (Ref 3) are in accord with the expression

$$E = (K + La)l + (H + Jl)t \quad (5)$$

which, at a constant wire length l , is of the same form as Eq (1). In Eq (5) K & J should be functions only of the ignition composition and should not change when the wire material is changed. Conversely La and H (at least for

similar solder joints) should change with wire material but not with igniter composition. These expectations are in accord with the observations of Jones (Ref 3). His experimental findings are summarized in the tabulation below:

Values of Critical Temperature and Critical Energy K for Various Matchhead Compositions		
Composition	LMNR/chlorate	Copper acetylide
Critical temp, °C	380	440
K, cal/cm	0.5×10^{-3}	0.6×10^{-3}

Composition	Charcoal/chlorate
Critical temp, °C	740
K, cal/cm	1.0×10^{-3}

Propagation of Ignition. As mentioned at the beginning of this article, burning, ie the propagation of ignition throughout the combustible medium, has been described in various articles of this Encyclopedia. However, since an important burning mechanism, proposed by Eyring et al (Ref 2), has not been described, we present this mechanism below (direct quote from Ref 2)

Rate Laws of Surface-Burning Reactions

It is of some interest to find the dependence of extent of reaction on time, for topochemical reactions of the surface-burning type, in which the *linear* rate of burning is constant

Example 1: Sphere uniformly ignited over its surface

Here the boundary between burned and unburned material is given by

$$\frac{R}{R_0} = 1 - \frac{t}{\tau}$$

and the fraction of material reacted is obviously

$$N = 1 - \left(\frac{R}{R_0}\right)^3$$

Therefore the rate law in its integrated form is

$$N = 1 - \left(1 - \frac{t}{\tau}\right)^3$$

Example 2: Sphere ignited at its center

Here the boundary between burned and unburned material is given by

$$\frac{R}{R_0} = \frac{t}{\tau}$$

and the fraction of material reacted is obviously

$$N = \left(\frac{R}{R_0}\right)^3$$

Therefore, the rate law is

$$N = \left(\frac{t}{\tau}\right)^3$$

Example 3: Sphere ignited at one point on its surface

Here the boundary between burned and unburned material is given by

$$\frac{R}{R_0} = 2 \frac{t}{\tau}$$

The fraction of material reacted is found by a simple integration to be

$$N = \frac{1}{2} \left(\frac{R}{R_0}\right)^3 - \frac{3}{16} \left(\frac{R}{R_0}\right)^4$$

Therefore, the rate law is

$$N = \left(\frac{t}{\tau}\right)^3 \cdot \left[4 - 3 \frac{t}{\tau}\right]$$

The dependence of N on t has been plotted in the following figure for these three examples

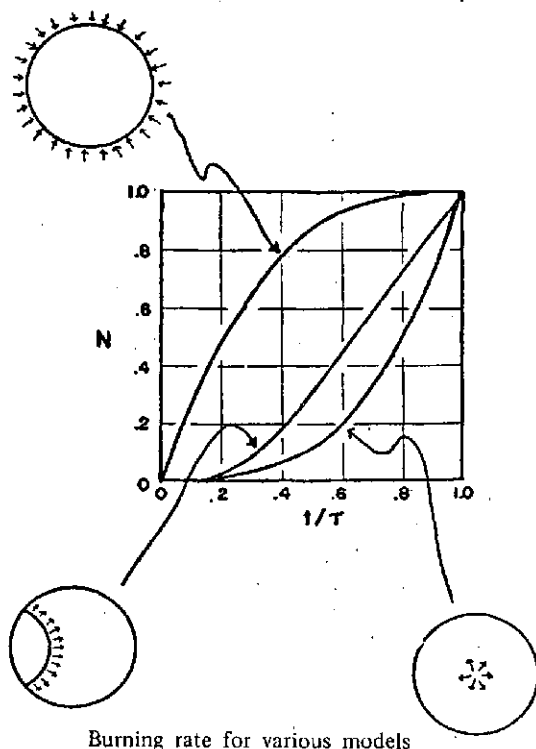

Burning rate for various models

General Observations on Ignition of Explosives.

In the preceding paragraphs we considered the general subject of ignition and not necessarily the ignition of explosives. Since the primary purpose of this Encyclopedia is the presentation of material relating to explosives, we present below a brief recapitulation of observations on the ignition of explosives

Primary explosives can be ignited and will burn without detonating if they are essentially unconfined (Refs 4 & 6). Lead Azide appears to be an exception because its ignition results in detonation or at most a very short-lived combustion which almost instantaneously goes over into detonation (Ref 6). However, dextrinated Lead Azide can be made to flash without detonating (Ref 5)

In order to secure proper functioning of an initiating compound, it is important that it can be ignited with comparative ease. Some initiating substances, however, such as Lead Azide are difficult to ignite, and for this reason are either mixed with easily ignitable substances, such as Lead Styphnate etc, or are primed by small quantities (0.2g) of some easily ignitable substances as Lead Styphnate or Lead Mononitroresorcinate

Secondary explosives will burn without detonating if unconfined or lightly confined. Some secondary explosives, such as PETN, are difficult to ignite and propagate burning only at slightly elevated ambient pressures

Propellants are designed to burn stably. However, ignition of unconsolidated propellants (high porosity) or large masses of propellant can result in detonation

Black Powder does not detonate, but under confinement it deflagrates (burns) so rapidly that its external effects are almost those of a detonation (Ref 6)

Written by J. ROTH

Refs: 1) M.V. Blanc et al, *JChemPhys* 15, 798 (1947) & *CA* 42, 762 (1947) 2) H. Eyring et al, *ChemRev* 45 (1), pp 164-5 (1949) 3) E. Jones, *ProcRoySoc (London)* A198, 523 (1949) 4) J. Roth, *Proc of Conference on Chemistry & Physics of Detonation* (Jan 1951), p 51 5) J. Roth, unpublished work (1951) 6) F.P Bowden & A.D. Yoffe, "Initiation and Growth of Explosion in Liquids and Solids," Cambridge University Press (1952) 7) B. Lewis & G. Von

Elbe, "Combustion, Flames and Explosions of Gases," Chap V, Sects 13 & 14, Academic Press, NY (1961)

2) **Ignition Cartridge.** Some mortar ammunition, eg, US Army 60 and 81mm mortars, is propelled by the so-called ignition cartridge (which resembles sporting cartridges in form). It is placed in the fin stabilizer tube and additional propellant increments are fastened to the fins by means of special wire holders. Charges in ignition cartridges (14.5 grains for 60mm and 24.0 grains for 81mm mortar) usually consist of small grains of double-base proplnt, NC 57.75 ± 1.50% with N = 13.25 ± 0.05%, NG 40.00 ± 1.50, K₂SO₄ 1.50 ± 0.50 & DPhA 0.75 ± 0.10%

Grain dimensions are: diameter 0.035" and thickness 0.00325" for the 60mm mortar, and 0.059" diam and 0.0100" thick for the 81mm mortar. The grains are ignited by means of a Black Powder pellet which in turn is ignited by a percussion primer. The flame from the ignition cartridge ignites the propellant increments
Refs: 1) Ohart (1946), pp 55 & 192 2) US Specification MIL-C-20480A (July 1954) (M3 Ignition Cartridge for 81mm Mortar Ammunition)

3) **Ignition or Igniting Compositions for Use With Explosives.** Any substance or composition intended to ignite (but not detonate or explode) an explosive belongs to this class. This should include not only all the primary ignition compositions, but also any ignition leads which then transmit the flame to other portions of the explosive device. It should be noted that, as there is no strict distinction between priming (which can explode or detonate) and igniting compositions, some of the mixtures given below might belong to either type

Numerous mixtures have been proposed for ignition of explosives. Of these, the most commonly used are mealed gunpowder, finely grained Black Powder, nitrocellulose mixed with other substances & finely divided smokeless powders mixed with other substances

For instance, for igniting propellant charges of smokeless powder, grained Black Powder is used, which in turn is ignited by means of a primary ignition composition

A primary igniting mixture of numerous US detonators consists of lead sulfocyanate 45±1

and potassium chlorate 55±1%

The primary igniting mixture in the M19 electric igniter (used for simulating gunflash) contains dinitrodiazophenol 40±3, potassium chlorate 58±3 and nitrostarch 2±0.5%. This mixture is ignited by heat produced by incandescent resistance wire and in turn ignites the charge of Black Powder placed next to it

The following examples of igniting mixtures are taken from Chemical Abstracts and arranged chronologically. Some of these compositions may be also classified as priming compositions

L. Fisher, **27**, 1758 (1933); Igniter charge for blasting caps consisting of $K_3Fe(CN)_6$ 20-40 with an oxidizer such as $KClO_3$ 10 to 30 and a nitrated carbohydrate such as NC 70-30; USP 1890112 (1932)

H. A. Lewis, **27**, 4931 (1933); Ignition composition used as a top (primary ignition) charge in blasting caps, comprising Pb thiocyanate, an oxidizer such as $KClO_3$ and a solid low-ignition-point fuel, such as pyro smokeless powder. This mixture ignited a priming charge of LA; USP 1918920 (1933)

H. A. Lewis, **28**, 4235 and 5242 (1934); Ignition composition for blasting caps contains: $K(SCN)_2$ 30-70, $KClO_3$ 30-60 and sulfur (as an accelerant) 1 to 20%; USP 1964825 (1934) & CanPat 340569 (1934)

C. P. Spaeth, **29**, 1252 (1935); Ignition charges for electric blasting caps containing Tetramethylene diperoxide either alone or with various admixtures; USP 1984846 (1934)

C. P. Spaeth, **29**, 5660 (1935); Ignition composition for the top charge in blasting caps, comprised of NC impregnated with a liquid explosive nitric ester, such as NG and $KClO_3$; USP 2007223 (1935)

O. A. Pickett, **29**, 6062 (1935); A thermally fired igniter charge for detonator caps contained zirconium mixed with $KClO_3$ and gum arabic or nitrostarch; USP 2008366 (1935)

C. E. Sosson, **29**, 7078 (1935); An ignition composition for use in low-tension electric fuse heads, comprised of a mixture of finely divided metallic zirconium 35 to 39% and an easily ignitable salt of nitrophenol or its derivatives, such as Pb-2-nitroresorcinate, 65 to 61. The mixture may be used either in loose form around the electric bridge or may be agglomerated with NC gel; BritP 428872 (1935)

E. Jones, **29**, 8336 (1935); A safety igniter suitable for use with burning (nondetonating) explosives, comprised of an electric fuse head (Zr + Pb-2-nitroresorcinate) and a combustible material, such as a mixture of finely divided Pb-Si + Pb_3O_4 , or Ca silicide + $PbCrO_4$, or Zn + $KMnO_4$ or Fe + $KMnO_4$. Both fuse heads as well as the combustible mixtures are of the kind producing very little or no gas. They are sealed inside a metal container which does not burst when the mixture is ignited, but is heated only on a portion of the surface to a temperature sufficient to ignite the blasting charge and not sufficient to ignite the firedamp; BritP 430750 (1935)

C. E. Sosson, **30**, 1564 (1936); Ignition composition suitable for use in delay detonators: zirconium 50 to 95 used with basic Lead-2-nitroresorcinate, $O_2N.C_6H_2(OH)_2.COOP(PbOH)$ (or other lead salts of nitrophenols) 50 to 5; USP 2027208 (1936)

E. Jones, **30**, 4324 (1936); Safety igniter for explosives, consisting of a Cu tube 33mm long, 6mm in diameter and 0.2mm thick containing a charge of 0.75g of finely divided Zn and 40% $KMnO_4$, loaded at a pressure of 60 psi. A fuse head of metallic Zr and Lead Styphnate (LSt) is placed close to the composition; CanP 357600 (1936)

J. Taylor & W. Young, **30**, 4324 (1936); A complicated device suitable for igniting safety blasting explosives without igniting firedamp; CanP 357532 (1935)

A. Stettbacher, **30**, 2387 (1936) and Nitrocellulose, **6**, 202 (1935); Chemical and mechanical delay igniters. A review, mainly of chemical delay incendiary bombs

L. A. Burrows, **31**, 6467 (1937); An ignition composition in an electric blasting initiator, comprising at least one of the compounds selected from the group consisting of the silver and mercury derivatives of chlorinated azodicarbonylamidine; USP 2086533 (1937)

L. Burrows, W. Filbert & E. E. Reid, **32**, 2357 (1938); Ignition charge suitable for electric blasting caps and containing bis-Triethyl Lead Styphnate, $C_6H(NO_2)_3 [OPb(C_2H_5)_3]$; USP 2105635 (1938)

B. Zielinski, **32**, 3964 (1938); Ignition mixtures suitable for percussion caps, primers, etc and consisting of LSt 20-50, Ba or Pb nitrate 30-50,

Sb_2S_3 5 to 30, a friction producing agent such as glass up to 20% and a sensitizer such as 2,4,6-Trinitro-1,3,5-triazido-benzene 0.25 to 10%; USP 2111719 (1938)

W. F. Filbert & W. E. Lawson, **32**, 5630 (1938); An ignition composition suitable for use in electric blasting initiators, contains the nitrated product of Pb-diphenylpropane mixed with Zr, $KClO_3$ and nitrostarch; USP 2118501 (1938)

E. Jones, **32**, 8147 (1938); A safety igniter suitable for blasting charges resembling the one described in CA **29**, 8336 (1935); USP 2127603 (1938)

C. G. Storm, **34**, 7605 (1940) and Army Ordnance, **21**, 20-30 (1940); Methods of improving ignition of propellant charges are discussed

L. Burrows & C. Van Winter, **35**, 2722 (1941); A slow ignition charge, comprised either of smokeless powder and an oxidizer, such as $KClO_3$ or KNO_3 with or without a metal, such as Al, Te, Mg, Se or Zr, or a mixture of smokeless powders. It is suitable for electric squibs. The mixture is heated by means of a bridge wire of Ni-Cr alloy with a diam of at least 0.00225", whereby certainty of firing is assured under conditions prevailing in series firing; USP 2228339 (1941)

E. I. duPont de Nemours & Co, **36**, 274 (1942); Ignition composition for use in electric blasting caps, consists of or includes a double salt of $Pb(NO_3)_2$ with a Pb salt of dinitrophenol; BritP 519749 (1940)

L. A. Burrows & G. A. Noddin, **36**, 2725 (1942); Ignition composition suitable for blasting explosives comprised of finely divided colloid smokeless powder mixed with 15-25% of the Pb salt of a dinitrophenol such as 4,6-dinitro-cresol- $[CH_3 \cdot C_6H_2(NO_2)_2O]_2 Pb$; USP 2268372 (1941)

J. Gillies, **41**, 6724 (1947); A primary ignition composition for igniting purposes, yielding little or no volatile matter among the products of its combustion, consists of a mixture of $CaSi_2$ and MnO_2 with or without CuO; BritP 575506 (1946)

E. Jones, **42**, 7532 (1948); Claims ignition device for use in military land mines, contg a priming compn consisting of a mixt of HgFulminate, Sb_2S_3 & $KClO_3$. The container for the

priming compn & other parts of the device are described & illustrated; BritP 574053 (1945)

Gévelot & Gaupilat, **47**, 8374 (1953); Claim an ignition compn for electrical primers, consisting of a mixture of dissolved Guncotton with PbO_2 (60%), Pb_3O_4 (65%) or $KMnO_4$ (50%). Addition of Sb_2S_3 , C, $KClO_3$ or $KClO_4$ modifies ignition props of above mixture; FrP 881262 (1943)

F. B. Clay & R. A. Sahlin, **49**, 14326 (1955); Igniter compns for tracer projectiles which include a Ca silicide fuel as a partial or complete replacement for Mg burn in such a manner as to give a dim or invisible trace to a min distance of 25 yds & a bright & properly colored trace at greater distances. A typical igniter comp is SrO_2 78, BaO_2 4, PbO_2 4, Ca silicide 7 and Ca resinate 7%; USP 2709129 (1955)

R. H. Heiskell, **50**, 5293 (1956); Claims a pyrotechnic compn as follows: A dark-burning, nonflash igniter mixt suitable to ignite the tracer compn within a projectile is composed of CuO 50, Mn 49, graphite or stearic acid 1% to act as binder. Other possible O-bearing compns include BaO_2 , Sb_2O_5 , PbO_2 & $PbCrO_4$. Another igniter mixt is composed of 80% BaO_2 & 20% sulfide from the group CaS, Cr_3S_4 & SeS, & a small amt of graphite or stearic acid; USP 2726943 (1955) & USP 2726944 (1956)

R. H. Heiskell, **50**, 8208 (1956); Claims highly stable, dark-burning igniter compns containing Bi_2O_3 45-85, Mn 15-55, stearic acid binder up to 10, and graphite lubricant up to 10%; USP 2716599 (1955) & USP 2726944 (1956)

R. H. Heiskell, **50**, 8208 (1956); Claims a nonluminous igniter for initiating ignition of the burster charge of a projectile, consisting of BaO_2 60-7, Sb_2S_3 21.3-35, asphaltum 1-4 & graphite 1-4%; USP 2714061 (1955)

T. J. Mulqueeny, **50**, 9742 (1956); Claims: Ignition compns of the Pb-Se type, where the PbO is produced *in situ*, were prep'd & evaluated for use in blasting caps & detonators. This type of mixt afforded less erratic firing times than when the PbO was mechanically incorporated. The Pb is oxidized by heating in an internally baffled rotating drum in an oxidizing atm; USP 2740703 (1956)

J. H. McLain & T. A. Ruble, **51**, 12494 (1957); An improved fuse for use in firing gas

grenades, smoke candles, etc, is provided by placing a standard primer (I), a first fire charge (II), a delay charge (III), & an ignition mixt (IV) in a fuse body. II, which is relatively insensitive to frictional impact, stable, substantially gasless, easily ignited, & has a high burning temp so as to act as a relay between I & III, is composed of $Pb_3O_4 \pm 2$, Si (V) 33.7 ± 2 , Mn 11.2 ± 1 , celluloid (VI) $1.8 \pm 0.2\%$. III, which has substantially the same characteristics as II except that on burning it produces a plug-forming residue to prevent backfiring, is composed of PbO 76.9, V 19.3, Fuller's earth 1.5, VI 1.8 & graphite 0.5%. IV which has substantially the same characteristics as II except that it gives a large flash & produces a large vol of gas, consists of $PbCrO_4$ 59 ± 5 , V 19.6 ± 3 , Mg 19.6 ± 3 & VI $1.8 \pm 0.2\%$. In practice a small pellet of II at about 0.188 inch diam & 0.2 inch height & weighing 0.3-0.4g & a pellet of III of about 0.188 inch diam & 0.3 inch height & weighing 0.6g are pressed in beneath the primer under a load pressure of 400-600 lb, another pellet of III is similarly incorporated. The cavity is filled with loose IV, & the whole is sealed with a crimped-in closure plug; USP 2792294 (1957)

Th. Goldschmidt, **52**, 3346 (1958); Safety igniter for miner's lamps prepd from Al-bearing Ce alloys; GerP 926654 (1955)

W. J. H. Schneider, **52**, 5825 (1958); Claims an igniter composition consisting of Tribasic Pb picrate, $Pb(C_6H_2O_7N_3)_2 \cdot 3PbO \cdot 2.5H_2O$, having an explosion point of $160-80^\circ$, and an ignition delay of 0.6, 1.5, and 4.7 sec at 260, 250, and 240° , resp, is prepd by reaction while hot of a sol Pb salt and a picric acid (I) soln contg 7.3-7.5 moles NaOH per mole of I; FrP 1026869 (1953)

Mulqueeny & F. R. Seavey, **52**, 7704 (1958); An explosive train for elec detonators and blasting caps is described having a cyclonite base charge, a Pb azide initiating charge, and an ignition charge; the initiating charge is placed between the ignition and base charges. The ignition compn consists of 30-50% loose, dry Hg fulminate (40-90% through 200-mesh sieve) mixed with 50-70% ground, dense propellant (100% through 60-mesh sieve). The propellant compn is diphenylamine 0.3-1.2, graphite 5.0 max, ash 3.0 max, moisture &

volatile compds 2.0 max, ether extractable compds 2.75% max, and Nitrocellulose (12.0 to 12.7%N) the balance. The av firing times in millisecc for caps charged with the various mixes are: 50/50 Hg fulminate/propellant ignition 3.6, total 10.9; 40/60 mix, 3.9 and 13.2; 30/70 mix, 5.3 and 18.0; USP 2825639 (1958)

D. T. Zebree, **53**, 17514 (1959); Claims an improved delay fuse for igniting primary explosive compositions in detonators & squibs. The preferred delay mixture consists of 60% BaO_2 , Se (75/25) & 40% Pb-Sn alloy (85/15). Ingredients should be in the $1-70\mu$ particle size range; USP 2892695

H. H. Williams & W. A. Gey, **53**, 22957 (1959); Claim an igniter material for ignition of solid propellants in a stable, reproducible manner, which builds up pressure gradually so as not to cause the propellant grain to chip or crack, consists of a mixt of polytrifluorethylene (I), B, & NH_4ClO_4 . The I, mol wt 500,000-1,000,000, serves as a binder for the other 2 materials & as an oxidizer for the metal. The particle size of the NH_4ClO_4 is $1-5\mu$. The compn is 5.5-7.5% B & the remainder NH_4ClO_4 & I in substantially equal amts; USP 2900242 (1959)

D. T. Zebree, **54**, 2745 (1960); Claims an initiating device having a delay fuse element & a loose ignition mixt (Pb 72.4/Se 27.6% by wt) in contact. Incorporation of 1-5% Si, which increases the heat of combustion of this mixt, compensates for deteriorations which occur in ignition mixes, esp useful for blasting caps; USP 2908559 (1959)

W. E. Schulz, **55**, 3062 (1961); Claims igniting comp, a mixt of Mg, Te & TeO_2 loosely packed for use in elec actuated squibs. The ignition temp of this mixt is higher than that of other squib compns; a 3-5 amp, or larger, firing current is typically desirable. Ignition time, functioning at low & high temps & at low pressures, storage stability etc are good. Typical compns are: 5/88/7; 16/78/6; 27/67/6; & 36/59/5% by wt Mg, Te & TeO_2 resp in each case; USP 2953447 (1960)

E. J. Walden, **55**, 25258 (1961); Claims ignition delays at $-65^\circ F$ of a rocket propellant from NH_4NO_3 & a butadiene-methyvinylpyridine copolymer (90:10) are reduced 50% by the inclusion of pellets composed of $KClO_4$ 26.5,

Ba(NO₃)₂ 16.6, Zr-Ni alloy (50:50) 53.9, & Et cellulose 3.0% embedded in the ignition-sustaining material; USP 2990683 (1961)

S. V. Peyton & E. Williams, **56**, 14523 (1962); Claim a compn for ignition by stab-pin or flash, containing Pb 2,4-dinitroresorcinate 50, Ba(NO₃)₂ 45, & tetrazene 5% by wt. It has very good thermal stability, & its life in hot & moist storage is very much longer than that of fulminate mixts. It is highly compatible with Al, Cu, brass & Sn-plated Cu & also with Pb(N₃)₂; BritP 892741 (1962)

L. G. Herring, **56**, 15720 (1962); Claims a pelleted igniter made by mixing a mixt of powd Zr & Ni with a powdered inorg oxidant & a small amt of Et cellulose; this mixt is pelleted & dried to remove excess solvent; USP 3017300 (1962)

J. D. Clark, **60**, 7864 (1964); Claims an igniter for a rocket propellant consisting of a HNO₃ soln of an amine nitrate, such as diisopropylamine nitrate, is provided by a dough-like mixt of about 85% of a metal hydride, such as LiH or LiAlH₄, mixed with about 15% of a dry rubber cement. The igniter presents a large contact surface & is supported within the rocket chamber in such a manner that, when the monopropellant is allowed to impinge on it, as through a spray nozzle, the heat of reaction increases the monopropellant to the ignition temp & heat of combustion causes decomp of the igniter; USP 3115005 (1963)

R. L. Shimpbaugh, **62**, 12969 (1965); Claims an ignition compn consisting of Ba chromate, boron & lead dioxide for use in electric detonators; USP 3123367 (1965)

W. A. Proell, **64**, 12454 (1966); Claims a mixt of Black Powders 30-50 & smokeless powder 50-70%, compressed into a coherent cake to be used for igniting propellants; USP 3234059 (1966)

(No author cited), **67**, 10158 (1967); Claims an ignition compn having excellent low pressure ignition properties, consisting of a monovalent or polyvalent metal powder, eg Al, Cu or Mg; a metal oxide, eg PbO₂ or BaO₂; & 15% B as an activator; GerP 1243067 (1967)

G. B. Young & S. J. Lubinski, **67**, 55840 (1967); Claim a new ignition charge resistant

to electrostatic discharges may be prepd from amorphous B & Pb oxides in the following mixt ranges: B 1.5-2.5, PbO 97.5-98.5; B 8-30, PbO 70-92; & B 15-30, Pb₃O₄ 70-85%. Thus, 10g 90-7% pure amorphous B & 490g 5μ 99% pure PbO are ball-milled with 0.7kg H₂O for 16 hrs, dried at 212-25°F to <0.1% H₂O, & passed through a 20-mesh screen. The screened particles are electrostatically gained by tumbling in a glass jar at 65 rpm for 2.25 hrs. When incorporated into a cap, these compns exhibit an a c breakdown voltage of 1.4-2.2kv. They also show a consistent bridgewire sensitivity & burn in a gasless & non-violent manner; USP 3317360 (1967)

D. H. Lee & D. D. Evans, **66**, 67510 (1967); Claim a simple, efficient means of ignition of the monopropellant N₂H₄, provided by use of a fluid bed consisting of carrier pellets of Al₂O₃ impregnated conventionally with a N₂H₄-decompnt catalyst such as a mixt of the oxides of Fe, Ni & Co, a layer of the pellets ~ 0.25 in thick at the N₂H₄ feed end of the bed being coated with a powerful, H₂O-soluble, solid oxidizer such as KMnO₄, KClO₃, or, preferably, I₂O₅ which causes ignition of the initial N₂H₄. The heat thus developed raising the temp of the bed sufficiently to self-sustain N₂H₄ decompn; USP 3298182 (1967)

4) **Ignition Compositions for Use With Pyrotechnics.** This subject was treated in considerable detail in Vol 4 under *Detonator, Igniters and Primers*, Sect 3, Part B & *Ignition Train Used in Pyrotechnics*, pp D759-768, with the following additional reference:

Gordon & Campbell studied preignition & ignition reactions of the pyrotechnic system Zn-C₆Cl₆-KClO₄. They found the following reactions to be responsible for preignition, ignition, and combustion phases of this system: (I) 3Zn + C₆Cl₆ → 3ZnCl₂ + C; (II) 4C + KClO₄ → KCl + 4CO(+CO₂); (III) 4Zn + KClO₄ → KCl + 4ZnO. Reaction I is exothermic and together with reaction II raises the temp of the system to >500°. At temps above 421° the preignition reaction III becomes highly exothermic and propagation ensues in the neighborhood of 520°

Ref: S. Gordon & C. Campbell, 5th Symp on Combustion (1955), p 277 & CA **50**, 573 (1956)

5) **Ignition of Firedamp and Coal Dust.** Many disastrous coal mine explosions have been caused by the ignition of firedamp (methane/air mixtures) and/or coal dust. The subject of firedamp-coal dust explosions has been studied extensively. Some of this extensive literature was reviewed in Vol 3 under *Coal Mine Explosions*, pp C360-378, & under *Coal Mining Explosives, Non-Permissible*, pp C437-444, & *Coal Mining Explosives, Permissible*, pp 444-459. Below we give recent references on the ignition of firedamp and present a cursory discussion of the mechanism of firedamp oxidation (ignition & combustion). This complex mechanism tends to explain the great variability in experimental results on firedamp ignition & to furnish some excuse for the unfortunate fact that coal mine explosions still occur even after almost a century of intensive international effort to eliminate them

The oxidation of methane (as well as other hydrocarbons) proceeds via a chain branching mechanism. Each of the stages of the chain branding mechanism: initiation, propagation & termination, may be affected to a different degree by relatively slight changes in ambient conditions under which oxidation takes place. The cumulative effect of these "slight" changes on the over-all reaction may be quite large and lead to ignition or non-ignition under what appears to be very similar circumstances. Similarly, once ignition has been effected, its propagation (burning and/or explosion) is also subject to the variability described above

The following reaction scheme is taken from Lewis & Von Elbe (Ref 1) to whom the reader is referred for details:

Initiation:

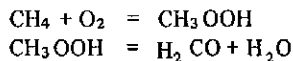

Propagation & Chain Branching

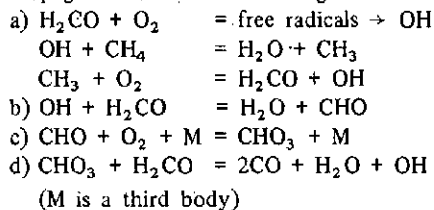

Termination:

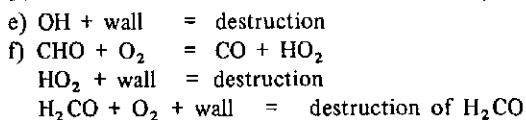

Without going into details, it is clear that the overall oxidation reaction will be affected by the fate of OH radicals (as well as other intermediates). For example, if the rate of step a) & d) exceeds that of steps b) & c) the oxidation of methane will proceed & conversely. Further complication is introduced because step d) depends on the relative rates of steps c) & f). Thus it is not surprising that minor changes in reaction conditions, which can affect different elementary reactions in different ways, can lead to major changes in overall reaction rate, and indeed be the difference between ignition & non-ignition

The ignition of firedamp (coal-dust explosion) are generally considered to be triggered by firedamp explosions, therefore we will make few further comments about coal dust explosions) by explosives presents its own set of problems. Among these are the high temperatures of detonation products, the possible presence of radicals in these products which can promote ignition in the methane (as discussed above), and the adiabatic compression and heating of firedamp pockets by the blast. Presumably all these possible ignition mechanisms are minimized by proper stemming of the bore-hole (Ref 2), the presumption being that the products and blast now emerging from the bore-hole have been attenuated in temperature, radical concentration & blast pressure. Experience shows that, although good stemming may be helpful in reducing the incidence of firedamp ignition, it does not completely eliminate ignitions. To some extent this may be due to fissures in the coal seam, containing firedamp, crossing the bore-hole. Also the amount of stemming required to obtain the necessary degree of attenuation may make its use uneconomical

Two approaches are now used in attempts to prevent firedamp ignition by explosives. The first attempts to reduce the temperature of detonation products of the explosive, and the second introduces flame-suppressing materials at and near the face where blasting

operations are carried out. The first scheme involves "sheathing" the explosive or incorporating into it materials that act as "heat sinks." This has been discussed in Vol 3, pp C437-444 & pp 444-459. The most widely used practical application of scheme two is "rock-dusting," ie dusting the inside of the mine with fine limestone. Rock-dusting appears to be quite effective in preventing coal-dust explosion but is not so effective in preventing methane-air explosions. Other dusts, such as lithium halides, appear to be more effective than limestone, but their use is not economical.

Modern coal-mining practice tends towards the use of mechanical devices, such as *Cardox*, *Hydrox* & *Mechanical Miners* rather than explosives. This will not necessarily reduce the number of coal mine explosions because these may be, and indeed are known to be, initiated by other means such as faulty electrical equipment, breakage of electrical cables or other means of producing a hot spark or arc

Written by J. ROTH

Refs: 1) B. Lewis & G. Von Elbe, "Combustion Flames & Explosion of Gases," Academic Press, NY (1961), pp 91-110 2) R. W. Van Dolah et al, US Bur of Mines, RI 5863 (1961) & CA 55, 27886 (1961)

References, & brief abstracts when available, to studies of firedamp and/or coal dust ignitions & explosions, not listed in previous Encyclopedia Vols are given below:

1) S. Shaw & D. Woodhead, "Igniters for Experimental Coal Dust Explosions," a review of the use of gaseous & solid initiators, gunpowder & cannon & low-concussion igniters (22 refs). Ministry of Fuel & Power, Safety in Mines Res Establ, Research Rept No 69 (1953) & CA 48, 9694 (1954)

2) Anon, "Ignition of Explosive Gas Mixtures by Friction," booklet by Ministry of Fuel & Power (London) (1954)

3) N. E. Hanna et al, US Bur Mines RI No 5463 (1959) & CA 53, 14517 (1959). The effect of 0, 3.6, 6.6 & 9.5% NaCl on the incendivity of permissible explosives was studied by the Bruceton up-and-down technique in gallery tests. The study showed that the addn of relatively small quantities of NaCl tends to reduce but does not eliminate ig-

nition of firedamp by these explosives

4) H. G. Wolfhard & M. Vanpée, "Ignition of Fuel-Air Mixtures by Hot Gases and Its Relationship to Firedamp Explosions," pp 446-53 in 7th Symp Combstn (1959)

5) R. W. Van Dolah et al, US Bur of Mines, RI 5863 (1961) & CA 55, 27886 (1961) "Relative efficacy of stemming materials in reducing incendivity of permissible explosives." Stemming, used to confine explosives in shot holes in underground coal mines, minimizes the chance of ignition of firedamp or coal dust by the detonation products. Tests by the Bureau of Mines indicate that NaCl, pure H₂O, gelled water (3% carboxymethyl cellulose), and a concd salt-H₂O soln are more effective than an equal wt of wet or dry fireclay. The H₂O, gelled H₂O, and salt-H₂O soln are equally effective. The approved stemming device is distinctly inferior to 1 lb of dry fireclay

6) N. E. Hanna et al, US Bur Mines RI 5867 (1961) & CA 55, 27886 (1961). "Factors affecting the incendivity of permissible explosives. Ammonium Nitrate and carbonaceous material." Analysis of 15 specially prepd explosives, with 3 particle-size ranges of NH₄NO₃ and 5 types of carbonaceous material, showed that the particle size of NH₄NO₃ in permissible-type formulations had a highly significant effect on the incendivity of the explosive to firedamp, with coarse NH₄NO₃ producing less incendive explosives than the fine. The type of carbonaceous material had no significant effect on the incendivity

7) W. J. Montgomery, CanMiningMetBull 55, 765 (1962) & CA 61, 11840 (1964). Review article on the explosive capacity of various dusts (coal & ore dust, esp sulfides). Measures for the prevention of explosions are described

8) J. Nagy & D. W. Mitchess, US Bur Mines RI No 6344 (1963) & CA 60, 6667 (1964). Data are given to assist in interpreting observations made after an explosion in an operating coal mine when evidence is collected to establish the cause & factors affecting ignition & propagation of the explosion

9) R. W. VanDolah et al, US Bur Mines RI No 6340 (1963) & CA 60, 6691 (1964). "Ignitibility of gallery atmospheres." Experiments show that a variation in the natural gas

content in the gallery can have a great effect on the ignitibility of the gallery atm; max ignitibility of the atm by permissible explosives occurs with ~8.1% natural gas. For similar explosives, incendivity increases with detonation velocity or bulk strength

10) D. V. Stoyanov, Vuglishta (Sofia) **19** (9), 25 (1964) & **CA 62**, 10257 (1965). The factors affecting the explosive properties of coal dust are the chem compn of the coal, the dispersion compn & conc of the coal dust, the compn of the mine atm, the source of the flame, the natural ash content, the moisture content & the volatile content of the coal. A nomogram is given by means of which the min amt of inert matter to be added to prevent an explosion can be determined from the natural ash content

11) J. Nagy et al, US Bur Mines RI No **6597** (3) (1965) & **CA 62**, 11591 (1965). "Explosibility of carbonaceous dusts." Activated carbons & charcoals were tested. In general only dusts having >8% volatile matter do not present an explosion hazard. Carbon black presented a fire rather than explosion hazard. All bituminous coal dusts are explosion hazards. In the 119 samples tested none with \leq 13% volatile content ignited by spark. Dusts having a 30% volatile content had 50% probability of ignition by spark. All dusts with \geq 40% volatile content ignited by spark

12) G. Yoshikawa et al, Kogyo Kayako Kyokai-shi **27** (6), 360 (1966) (Eng/Japan) & **CA 67**, 75024 (1967). Based on high-speed motion pictures of firedamp ignition by typical coal-mine dynamite shots, hydrodynamic-thermodynamic analysis is made on the expanding flow of gaseous detonation products with salts dispersing in them. Detonation products attained highest velocity at a distance from the charge at twice its diam, set up a shock wave in the surrounding firedamp atm, & decreased in velocity as expansion proceeded

13) D. Rae, Safety in Mines Res Estab, Res Rept **253** (1967) & **CA 69**, 1140 (1968). "The main characteristics of slow coal-dust explosions and their relation to the testing of barriers." The main characteristics of slow coal-dust explosions in the new gallery at Buxton are a const initial flame front acceleration from

practically zero velocity up to a speed of about 120 m/sec, followed by an increasing acceleration of the flame front. The initial acceleration is detd wholly by the effect of the igniter on the dust deposit and is made evident by plotting the square of the flame arrival time against distance, but the subsequent increasing acceleration is due to the flame of the explosion. This behavior is found also in other exptl galleries where the ignition zone is short and where the main fuel in the ignition zone is the same as in the deposit in the rest of the gallery. The violence of an explosion can be characterized by the initial acceleration, which can be used to compare explosions in different galleries. The min acceleration that will sustain an explosion without oscillation of the flame along the gallery is inversely proportional to the length of the gallery, explosions in long underground roadways can accelerate more slowly without suffering oscillations than those in short exptl galleries, and this may be important in the siting of explosion barriers

14) R. W. VanDolah et al, US Bur Mines RI No **7195** (1968) & **CA 70**, 13126 (1969). "Development of Slurry Explosives for Use in Potentially Flammable Gas Atmospheres." In this rept expts with 23AN-based slurry expls showed that it is possible to have them cap-sensitive and relatively nonincendive. All slurries that used flaked Al were sensitive to No 6 EBC (electric blasting cap) except one contg AN 47.2, NaCl 10, water 30, Al (particle size 12 μ) 8, sugar 3.5, guar gum 1.0 & buffer 0.3%. Buffer (consisting of NaOH & KH₂PO₄ in 1:29 ratio) was added to hold the pH at 4.5-5.5

15) V. P. Gorkovenko et al, Vzryvnoye Delo **1970** (68/25), pp 116-22 & **CA 73**, 89710 (1970). Evaluation of the permissibility of AN-based expls was conducted by comparing oscillograms of light emitted during explns. The amplitude and time of light emissions, dependence betw their values, and the probability of ignition of methane-air mixts were detd

16) B. N. Kukib & B. D. Rossi, Ibid **1970** (68/25), 123-27 & **CA 73**, 89703 (1970). Comparison of permissibility of various expls was

done by detg the "selectivity index;" $S = (V_1 - V_2)/V_3$, where V 's are volumes of gaseous expln products (V_1 , obtd on expln in a steel tube and a sand wad in the Dolgov Bomb; V_2 , obtd on expln in a free space in the Dolgov Bomb; and V_3 , calculated

17) L. V. Dubnov & A. I. Romanov, *Ibid* 1970 (68/25), 127-31 & CA 73, 89721 (1970). Techniques for evaluating the combustion tendency of permissible expls, is discussed. The value $\psi = (S_2 - S_1)/S_1$, where S_1 is av (50%) transmission distance in air (gap) of initiation of deton and S_2 is av (50%) transmission distance of combstrn, is taken as a basis for evaluation of the combstrn tendency. The transmission distance was detd by expln of a composite cartridge consisting of active and passive segments with air gaps between them

18) Anon (US Dept Intr) Fed Regist 28 Aug 1971, 36, 17336 & CA 75, 14265 (1971). Standards for preventing explosions from explosive gases other than methane & procedures for testing accumulations of such gases: the following gases shall not be allowed to accumulate in underground coal mines in excess of the concs (vol%) listed: CO 2.5; H 0.8; H₂S 0.8; C₂H₂ 0.4; C₃H₈ 0.4; & MAPP (methylacetylene-propylene-propadiene) 0.3

Recent review articles are:

- 1) H. Kaffanke, Maitrise Degagement Grisouteux, Amelior Climat Mines, Journees Inform, (Luxembourg), 1971, 217 & CA 76, 144547 (1972); prediction of firedamp emissions
- 2) M. Boutonnat et al, *Ibid*, 355 & CA 76, 144545 (1972); equipment for measurement of firedamp & ventilation control
- 3) H. Eicker, *Ibid*, 373 & CA 76, 144544 (1972); maintenance of firedamp meters & transmission of measured values

6) Ignition, Spontaneous, of Explosives.

This section presents some historical examples of *spontaneous ignition*. A more technical discussion of spontaneous ignition will be given under *Thermal Explosion, Catalytic Effects* in a future Vol

Explosives containing improperly stabilized ingredients such as NC or NG, decompose in storage, especially at tropical temperatures, with evolution of nitrogen oxides, formation of nitric

acid (and nitrous acid) and a rise in temperature. As these nitrogen compounds act autocatalytically, the temperature and rate of decomposition increase progressively until a point is reached at which the powder ignites spontaneously, ie without any external stimulus

For underoxidized compositions, stored in closed containers, the combustion process following spontaneous ignition may be incomplete. However, gases generated by this process will generally burst the container and after-burning may occur and contribute to the general conflagration which in turn can lead to explosion of any remaining unreacted material some of which ignited spontaneously or of other nearby explosive charges

Propellants were especially susceptible to spontaneous ignition before it was learned how to stabilize the NC. This was done by including substances called stabilizers in the propellant formulations. These substances, such as diphenylamine, centralite etc absorb the nitrogen oxides as they are formed, thus removing them from the sphere of reaction. This prevents further decomposition and the rise in temperature which decomposition produces. For similar reasons, it is advisable to keep the storage magazines cool and, in fact, since the catastrophe aboard the French battleship *Jéna*, occurring in 1907, nearly all countries introduced refrigerating systems for cooling the magazines on ships

Many disastrous explosions occurred at the end of the 19th and beginning of the 20th century, which were caused by spontaneous ignition of propellants either containing no stabilizers or containing those which were ineffective, such as amyl alcohol used in some French powders

Among the disasters caused by spontaneous ignition of propellants may be cited:

Japanese battleship, *Mikasa*, destroyed in 1905 with 599 men lost

Brazilian warship, *Aquidaban*, destroyed in 1906 with 213 lives lost

French battleship, *Jéna*, exploded in 1907 with 114 lives lost

Japanese ship, *Matsushima*, destroyed in 1908 with 114 men killed

Land magazine of *Batuco*, in Chile, in 1908

French battleship, *Liberté*, destroyed in 1911 with 204 men killed

Italian warship, *Benedetto Brin*, in 1915

The explosion of the Russian dreadnaught of the Black Sea Navy, *Empress Marie*, which occurred during WWI, was probably due to the same reason, although there is a chance that it might have been due to sabotage

Even as insensitive a material as Ammonium Nitrate, AN, may be subject to spontaneous ignition. The disastrous explosions of two ships at Texas City in 1947 could have been a consequence of the spontaneous ignition of paper-bagged fertilizer grade AN. The actual ignition may have occurred during rail shipment and later developed into a full-scale deflagration and subsequent detonation in the hold of *SS Grandcamp*. Spontaneous ignition may have resulted from the AN being bagged while it was too hot and/or improper removal of acid from the AN. Both these conditions could lead to autocatalytic decomposition which can result in spontaneous ignition. For alternate explanations of possible causes of the fire that resulted in the Texas City disaster see Vol 1, A 358-362

Refs: 1) Marshall 2 (1917), p 632 2) R. Oelmann, SS 4, 265 (1909) 3) Capt Persius, SS 10, 276 (1915)

7) Ignition Tests are historically divided into two categories:

A. Those testing the response of a substance to an open flame; ie determination of the flame temperature at which a substance ignites and remains burning. Usually this temp is a few degrees higher than the so-called flash point of the substance

B. Those testing the behavior of materials exposed to high temperatures in the absence of an open flame. These tests are used to determine so-called *ignition* or *explosion temperatures*. Ignition or explosion temperature is an indefinite quantity since its evaluation depends strongly on the conditions of measurement. As an example of this variability and dependence on test conditions, the "explosion temperatures" for as *standard an explosive as TNT* are quoted from 290 to 570°! (Ref 16)

C. Measurement of times to ignition of explosive exposed to hot flames.

In view of the above the following *ignition tests & ignition temperature tests* are primarily of historical interest. They also serve to outline the difficulties encountered in trying to characterize quantitatively the response of explosives to heat. Quantitative treatment of "explosion temperatures" and delay to explosion (induction time) and the parameters of the explosive that affect these quantities will be presented in a future Vol under "Thermal Explosions"

A. Flame Tests

The International Committee on Explosives and the German Railway Commission prescribed the following ignition tests, applied mostly to safety explosives. It is advisable to conduct these tests behind a protecting barricade

a) *Fuse Test*. Place 3g of powdered explosive in a short glass or paper tube, about 2cm in diameter, and tap it gently to give the explosive an even surface. Introduce a slow burning fuse (rate 1cm/sec) and ignite it. If the explosive ignites, it is classified as a deflagrating or readily inflammable explosive. Also observe whether the explosive burns partly or completely and note the time elapsed between lighting the fuse and ignition of the test sample

b) *Red Hot Iron Basin Test*. If the explosive passed test a) without igniting, it is submitted in the following test to a much higher temperature in order to be sure that it is not liable to explode when exposed to fire

By means of a burner, heat to red heat a hemispherical iron basin 12cm in diameter and 1mm thick and introduce a small quantity, not more than 0.5g, of the explosive to be tested. If no explosion takes place, introduce more of the explosive, gradually increasing the quantity until a weight of 5g is reached and repeat the test with 5 g three times. Observe the manner in which the explosive burns and the time that elapses between adding the explosive to the basin to the extinction of the flame

c) *Red Hot Iron Test*. This test is designed to ascertain the inability of safety explosives to explode on heating or to burn continuously

Heat the end of an iron bar, 15mm in diameter, for a length of 10cm to a cherry red heat (about 900°) and plunge it into a small quantity of explosive placed on a sheet of asbestos. If the explosive does not ignite or is difficult to ignite, and burns slowly without explosion,

and the flame dies the moment the hot bar is withdrawn, continue testing fresh portions of it, gradually increasing the amount of sample up to 100g. If the explosive still behaves as described above, it is considered to have passed the test

This test is not mentioned among German Railway Commission tests, instead, the following two tests are prescribed:

d) *Iron Basin with Wood's Metal Test.* Fill an iron basin, 14cm diam and 7cm high, to within 2cm of the top with molten Wood's metal and insert an armored thermometer or a thermocouple in the middle of the molten mass. Heat the basin and, as soon as the temperature reaches 100°, place 3 test tubes (15 mm id and 120mm long) containing 0.2-0.5g of powdered explosive about 50mm away from the thermometer, spaced about 100mm apart and immersed 20mm into the bath. Raise the temperature of the bath at the rate of 20° per minute until ignition occurs or until the temperature reaches 320°

Note: The test may also be conducted by raising the temperature 5°/min (Ref 2)

e) *Iron Box Test.* Place 0.5 to 1kg of the explosive to be tested in a sheet iron, riveted box 1mm thick and 85 x 85 x 85mm in size. Fasten the lid by means of iron wire, bound crosswise around the box and place the box in a brisk wood fire (by means of a mechanical device operated by remote control). The explosive is considered to have passed this test if it does not ignite or explode within 10 minutes.

Notes:

a. This test has to be carried out in the open and not less than 100 meters from inhabited buildings

b. If it is known that the explosive is not sensitive, the box may be laid by hand provided it has been wrapped up well beforehand in several layers of paper so that the explosive will not be ignited too soon

Fleischer & Burtle (Ref 3) give results for a flame test for different types of Lead Azide. In this test a std safety fuse provides the flame and percent firing of the Lead Azides is recorded as a function of distance from the fuse as shown in the tabulation below:

Lead Azide	Distances from Fuse (inches)					
	½	4	12	16	20	22
Dextrinated	100%	20	0	—	—	—
Pure	100	100	100	80	0	—
PVA	100	100	100	60	40	0

Refs: 1) Marshall 2 (1917), pp 437-38 2) Reilly (1938), p 66 3) J. Fleischer & J. B. Burtle, USP 2421778 (1947) & CA 41, 5724 (1947)

B. Ignition Temperature of Explosives, Tests. (Verpuffungstemperatur or Entzündungspunkte, in German and Inflammation, in French). When an explosive is heated by means other than an open flame, a temperature is reached at which the sample ignites and burns or deflagrates producing a flame or fumes off without any loud report, or finally explodes or detonates with a loud report. This test should not be confused with either the "flash point" or "ignition point" test (see Sect A) in which a substance, preheated to a certain temperature, is ignited by means of an open flame, whereas in the "ignition temperature" test no outside flame is used

Numerous tests exist for determining ignition temperature, but few of them give the same result. Results may vary as much as 100° depending on the method used, on the rate of heating, on the size of the sample used, on the state of division etc. See *Thermal Explosions* for a discussion of why measurement variables affect ignition temp results

One of the most reproducible of these tests is described under "Explosion Temperature Test," an official test at Picatinny Arsenal (Ref 15). This test is applicable to the determination of ignition point, decomposition point, deflagration point etc for those explosives which do not really explode under conditions of the test

Some other "ignition temperature" tests are shown below:

a) *German Railway Commission Test* (Refs 1, 2 & 3). A small sample of an explosive (0.1g for all explosives; except Black Powder, NH_4NO_3 , and chlorates, for which 0.50g is used) is placed in a test tube, 125mm long, 15mm id and 0.5mm thick, which is tightly corked and placed in a paraffin or Wood's metal bath provided with a stirrer and thermometer and preheated to 100°. Heating is continued with stirring so that the temperature

increases 5° per minute and the point is noted at which the sample ignites, fumes off etc

A. Pérez Ara (Ref 3, p 109) gives the following temperatures for explosives tested by this method:

Black Powder 225 to 300, NC (13%N) 185, smokeless powder 185, NG 160, Nitrostarch 170, NH₄NO₃ 225, Tetryl 190, Mercury Azide 200, Silver Azide 200, Lead Azide 340 to 350, Cuprous Azide 210 to 350, Cupric Azide 245, Mercuric Fulminate 160 to 200, Silver Fulminate 200, Cheddite 200, blasting gelatin 207 to 211 and Picric Acid 225 to 350°

b) *A Test Described by A. Pérez Ara (Ref 3) and Datta & Chatterjee (Ref 6)*. The above apparatus is used but the empty test tubes are preheated in the bath to different temperatures depending on the explosive to be tested. At this point, a small (0.10 to 0.50g) sample is added to one of the empty tubes and if no ignition takes place the temperature is raised about 5° and a new sample is thrown into the tube. The test is continued until the sample either ignites, fumes off or explodes. If the sample ignites at the first trial, the temperature is lowered 5-10° and the test repeated and continued at progressively lower temperatures until one is reached at which the sample does not ignite. After this, the temperature is raised again and the point is noted at which the sample ignites

Usually, this test gives higher results than the method a) (Ref 3)

Note: Datta & Chatterjee used a KHSO₄ bath which they heated up to 500°. Kast and Haid tested a number of initiating explosives by both methods (Ref 11) and found that, although most explosives give higher results by method b), there are many cases in which both methods give the same results, especially if heating is conducted at a rate of 20° per minute in method a)

	Method a) Heating at 20°/min	Method b)
Cyanuric Triazide	207°	205°
Lead Azide	339	360
Mercuric Fulminate	172	215
Mercuric Fulminate 80 + KClO ₃ 20	170	215
Lead Styphnate	276	275

c) *Methods of Direct Ignition of Kast (Ref 3)*. A small quantity of explosive (up to 0.5g) is placed on a small iron plate and an attempt is made to ignite it by the flame of a splint of wood. Another small sample of explosive is touched with a thin iron rod, preheated to red heat. Another small sample is thrown into an iron dish of about 12cm diameter, preheated to red heat

d) *Spanish Method (Ref 1, v 2, pp 435-6)*. A long copper strip, 15mm thick and 80mm wide, is heated at one end with two gas burners. The other end of the copper strip has a circular holder with five holes containing copper test tubes. The central test tube is filled with mercury and contains a thermometer while the other four, placed around the first, contain 0.1g samples of explosives. Heating is continued until one of the samples in one of the test tubes nearest the heated end ignites or explodes and the temperature is noted. The remaining samples ignite a bit later. The average temperature of ignition of all the samples is taken as the "ignition temperature"

e) *Ignition Temperature by Fisher-Johns Apparatus, by Kofler Micro Hot Stage, by Dennis Melting Point Apparatus or by the Maquenne Block*. The first apparatus is described in Fisher's Catalogue No 80, p 619, No 12-142

The second is shown in Arthur H. Thomas Catalogue (1950 ed), pp 877-880

The third and fourth devices are described in R. L. Shriner & R. C. Fuson, "Systematic Identification of Organic Compounds," J. Wiley, NY (1940), pp 88-89 (see also L. M. Dennis & R. S. Shelton, JACS, 52, 3128 (1930) and Arthur H. Thomas Catalogue (1950), p 818)

Essentially, all of these devices consist of a metallic block or bar heated either by gas (as in the Maquenne Block) or by an electric heater. The test may be conducted by placing a few small grains of explosive on the preheated block and noting the temperature at which the sample ignites, deflagrates or explodes by means of a thermometer installed inside the block

Tests conducted at Picatinny Arsenal with these devices showed that fairly consistent results may be obtained for a given explosive if all determinations are made under the same conditions (same rate of heating, size of grains,

size of sample etc)

f) *Method of Snelling and Storm*. In this method (Ref 5), a 2-3g sample of NG was heated in a test tube immersed in a paraffin bath provided with a thermometer. The temperature of the NG inside the tube was measured by means of a Cu-constantan thermocouple. The experiment is conducted behind a barricade. The following results are for a period of heating equal to 5 minutes:

	Temperature of	
	Bath	Sample
At the start of heating the NG	80	49
NG appears to boil owing to rapid evolution of water and oxides of nitrogen	174	145
Vigorous boiling (bubbling) of NG	186	165
NG becomes thick & viscous	193	185
Temperature of sample rises faster than that of the bath	198	205
Violent detonation	201.5°	215-218°

If the rise in temperature is slow, the sample decomposes and partly chars at temperatures above 180° without producing any explosion

g) *Method of Micewicz and Majkowski*. This method (Ref 14) may be considered to be a modification of the Snelling and Storm's method described above

M & M examined several high explosives and found that in many cases the temperature of the explosives rises considerably above that

of the bath during heating (on account of the exothermic decomposition that takes place) but sometimes it falls again before ignition takes place

h) *Koehler and Marquoyrol* (Ref 8) determined the ignition temperature of NC in vacuo, in air, and in an atmosphere of CO₂. They came to the conclusion that the results are practically the same and are as follows:

Guncotton (CP ₁) with N=13%	180 to 190°
Collodion cotton (CP ₂) with N=12%	186 to 189°
Poudre B	174 to 187°

i) *Stettbacher* (Ref 9) comments on the great variance of results for the ignition temperature of NG, ranging from 180° by Nobel to 220-255° by Staudinger, and criticizes the various methods of determination

j) *Taylor and Rinkenbach* (Ref 12) determined ignition points of various explosives by dropping small portions onto a block of heated Wood's alloy:

Explosive	Ign Temp
Mercuric Fulminate	260°
MF + 10% KClO ₃	240
MF + 20% KClO ₃	235
Silver Fulminate	245
Lead Azide	383
Silver Azide	273
Mercurous Azide	298
Lead Styphnate	293
Silver Acetylide	220-225
Lead Picrate	281

The following table gives values for TNT, PA and Tetryl:

Explosive	Time* of Heating (min)	Temp of Bath at Ignition or Explosion	Max Temp of Explosive reached during Heating	Temp of sample at Ignition	Remarks
TNT	11.55	294°	299°	248°	Ignition
TNT	19.87	288	296	276	Ignition
TNT	39.58	283	294	284	Ignition
PA	13.25	289	305	243	Ignition
PA	17.17	289	301	281	Ignition
PA	19.25	293	296	247	Ignition
PA	36.47	283	298	262	Ignition
Tetryl	18.43	189	202	202	Explosion
Tetryl	5.87	182	232	232	Explosion
Tetryl	5.27	189	214	214	Explosion

*Measured from the moment the bath reached 100°

Silver Picrate	335
Barium Picrate	403
Copper Picrate	373
Hexamethylenetriperoxidodiamine	200
Mannitol Hexanitrate	232
Dulcitol Hexanitrate	205
Cyanuric Triazide	252

k) *Tammann & Kröger* (Ref 13) examined numerous liquid and solid explosives and came to the following conclusions:

1) The explosion (ignition) temperature decreases with increasing size of sample and increases with rate of heating

2) With volatile explosives which melt before exploding, the required explosive sample weights are appreciably higher (20 to 100mg) than with non-volatile explosives (0.4 to 10mg)

3) With volatile explosives giving gaseous products of explosion, the substance evaporates or decomposes before the explosive limits are reached

4) The dependence of explosion temperature upon rate of heating is almost always linear, with the exception of potassium picrate

5) TNT begins to decompose at 150° and on long heating at constant temperature, the explosion temperature is raised by the formation of decomposition products

l) *Method employed at Picatinny Arsenal* (Ref 15) is given under "Explosion Temperature"

m) *A Manometric-bomb Method* for determination of the ignitability of an explosive is described by Rogozhnikov et al (Ref 17). By this method, the min amt of igniter required to initiate steady combustion (at increasing pressure) of an explosive is determined; simultaneously, the pressure increase with time is measured. 20 explosive compns were tested. The method is useful for investigation of the effects of various additives to the explosives on their ignitability

Refs: 1) Marshall (1917) 2, 435 & 758; (1932) 3, 130-135 2) Reilly (1938), p 66 3) A. Pérez Ara (1945), pp 108-9 4) G. Finzi, Gazz Chim Ital, 39, 549 (1909) & SS, 5, 153 (1910) 5) W.O. Snelling & C.G. Storm, SS, 8, 1-4 (1913) & CA 7, 1416 (1913) 6) R.L. Datta & N.R. Chatterjee, JCS, 115, 1006 (1919) 7) A. Schrimpf, SS, 15, 93 (1920) 8) Koehler & Marquayrol, MP, 18, 138 (1921) 9) A. Stettbacher, ZAngewChem, 36, 60 (1923) & CA 17,

2191 (1923) 10) H. Kast, ZAngewChem, 36, 402 (1923) & CA 17, 3608 (1923) 11) H. Kast & A. Haid, ZAngewChem, 38, 48 (1925) & CA 19, 1197 (1925) 12) C.A. Taylor & W.H. Rinckenbach, JFrankInst, 204, 369 (1927) 13) G. Tammann & G. Kröger, ZAnorgChem, 169, pp 1-32 (1928) & CA 22, 2058 (1928) 14) S. Micewicz & K. Majkowski, SS, 23, 422 (1928) 15) A.J. Clear, PATR 1401, Rev 1, (28 Feb 1950) & PATR 3278, Rev 1 (April 1970) 16) Anon, NOLR 1111 (1952), pp 2-27 17) V.M. Rogozhnikov & V.P. Lushkin, Vzryvnoe Delo, 1970, No 68/25, 134 (Russ) & CA 73, 100608 (1970)

n) *Ignition Temperature Test* (Method of M. Kostevitch). In the methods described above as well as in the method practiced at Picatinny Arsenal (see Explosion Test in Vol 1, pp XVI & XVII), in which an explosive is placed in a blasting cap shell which is then put into Wood's metal preheated to a temperature close to the melting point of the explosive, the explosive itself cannot be seen during testing and any melting, decomposition or other phenomenon that takes place cannot be noted. In order to observe all stages of behavior of an explosive, Col Kostevitch proposed to use an all glass apparatus, originally developed by the Imperial Russian Ordnance Dept in 1908 for the determination of melting points of high explosives, such as TNT, PA etc. This apparatus is essentially the same as that described in US Specification MIL-T-248A and used for the determination of setting points of TNT and other high explosives

It consists of a heavy-walled glass test tube, provided with a stopper and a thermometer. This tube is inserted by means of a rubber stopper into a 2nd test tube of larger diameter, serving as an air jacket. The ensemble is inserted, by means of another stopper, into a beaker filled with a nonflammable, transparent, high boiling point liquid (eg dibutylphthalate or silicones) and provided with a thermometer and a mechanical or hand stirrer with a ring at the lower end

In the Kostevitch method a sample of explosive (about 0.1g) is introduced into a small glass bulb (volume=ca 3.5cc), resembling in appearance that used for weighing fuming acids, but made from a larger diameter tube in order

to facilitate the introduction of the explosive. The tube of the bulb is inserted in a hole drilled in the stopper of the outer test tube. This stopper also contains a thermometer. The bulb of the tube and that of the thermometer are so arranged that they are on the same level. After the liquid is preheated to about 100°, the bulb with the sample is introduced and heating is continued in such a manner that the rise of temperature is uniform, say 5° to 20° per minute. The behavior of the sample is observed during the entire period of heating and the temperatures are noted at which the sample begins to fume off, when the flash appears and finally when the tube fills with black smoke

Refs: 1) M.M. Kostevitch, *SS*, 23, 156 (1928) & private communication 2) Reilly (1938), p 144 3) US Specification MIL-T-248A (Oct 1963)

C. Ignition Times for Flame Exposures.

In order to measure the time required to ignite explosives exposed to flames, several devices have been proposed. Among these the pendulum of Prof Cronquist of Sweden appears to be the simplest (Ref 2). It consists of a metallic pendulum, 2.5-3m long, making a swing of 75cm at a rate of 1cm in 1/50 second. A small sample of explosive is attached to the lower end of the pendulum and, as the pendulum swings, it passes through a row of 5 small flat gas burners arranged in the form of an arch. Each burner has a flame 15cm long. If, for instance, the explosive ignites after passing two burners, the time is $15 \times 2 \times 1/50 = 0.6$ seconds. Cronquist gives the following results: Small grain Black Powder 3.20 to 4.50 sec; single-base smokeless powder for small arms (nongraphited) 0.44 to 0.90 sec; same, graphited 1.96 to 3.28; Cordite (old type) 0.16 to 0.30 and Ballistite 0.16 to 0.40 sec

N. C. Hansen of Denmark (Ref 3) proposed an apparatus consisting of a pendulum 2.35 meters long swinging through a single gas burner. The duration of contact with flame is regulated by starting the swing from different positions—the greater the lateral displacement at the start of the swing, the shorter the duration of contact with the flame. Test results are expressed in centimeters from the start of the swing to the center of the flame, eg the

maximum distance at which no ignition takes place in ten trials. These values can be easily converted to the duration of contact with flame

Refs: 1) Marshall 2 (1917), p 437 2) A.W. Cronquist, *SS*, 1, 106 (1906) 3) N.C. Hansen, *SS*, 8, 165 (1913)

8) Ignition Theory of Explosives.

Some of this material was presented in Sect 1 above. Other material will be described under "Thermal Explosions" in a future Vol. Below we list and abstract several references specifically directed to the theory and/or mechanism of ignition of explosives

On the basis of this study of the preignition, ignition & combustion reactions of Black Powder by thermoanalytical techniques, Campbell and Weingarten (Ref 1) proposed that the preignition reaction (1) is between S & KNO₃, which is sufficiently exothermal to activate the propagative combustion reaction between charcoal & KNO₃ (2): $S + 2KNO_3 \rightarrow K_2SO_4 + 2NO$ (1) & $3C + 2KNO_3 \rightarrow K_2CO_3 + N_2 + CO_2 + CO$ (2). In (1) the S is in a molten state & the KNO₃ is in its thermally active trigonal form. In (2) the charcoal is in the solid state & the KNO₃ is in a molten condition

Librovich (Ref 2) gives: A math treatment of the ignition of propellants and explosives. It is assumed that ignition is caused by a stream of hot gases and that evapn of the condensed phase results entirely from the heat liberated at the burning surface. Ethylene dinitrate is used as an example. With a surface temp of 473°K, 4.62 cal/cm² is required for ignition

Khlevnoi (Ref 3) analyzed the process of ignition of a nonmelting explosive by a hot metal plate for model conditions (specified). Equations were derived describing the max temp on the surface of the explosive, the temp distribution in the explosive at the time of ignition, the criterion of ignition, etc

Refs: 1) C. Campbell & G. Weingarten, *Trans FaradSoc* 55, (12) 2221. (1959) & *CA* 54, 16136 (1960) 2) V.B. Librovich, *ZhPriklMekhan i Tekhn Fiz* (1963) (6), 74 & *CA* 60, 14325 (1964) 3) S.S. Khlevnoi, *FizGoreniya Vzryva* 1970, 6 (3), 295 & *CA* 74, 77969 (1971)

Illuminating Devices and Compositions. Any pyrotechnic device or composition producing intense light and serving to illuminate various objects such as enemy territory at night, either for observation or photography, or for locating targets for bombing etc, or illumination of air-fields for landing at night, in rain or fog

Among illuminating devices may be cited flares (ground or airplane), photoflash bombs, illuminating projectiles (star shells), position lights etc

Illuminating devices generally produce either white or yellow-tinted light (although some colored lights are also used) of great intensity, ranging from several tens to several hundreds of thousands candle power per square inch. Among the older illuminating compositions used during WWI are:

White light mixture for airplane flares: $\text{Ba}(\text{NO}_3)_2$ 76, Al (powder) 9.75, Al (flake) 8.25, S (flour) 4.0, castor oil or vaseline 2.0%; Intensity about 350,000 candle power (Ref 1, v 2, p 111)

White light for wing-tip flares: $\text{Ba}(\text{NO}_3)_2$ 81.0, Al (flake) 13.7, sulfur 5.3% (Ibid p 225)

White light for position signals: $\text{Ba}(\text{NO}_3)_2$ 66.9, Al (flake) 15.5, sulfur 16.7, Sb_2S_3 0.6, stearin 0.3% (Ibid p 206)

French white fire: KNO_3 57.1, Sb (metallic powder) 19.1, Pb_3O_4 (red lead) 17.5, sulfur 6.3% (Ref 1, v 1, p 189)

German white illuminating compound: fired from special pistols, contained $\text{Ba}(\text{NO}_3)_2$ 61.5, Al (powder) 20 and sulfur 18.9% (Ibid p 191)

After WWI, most of the research and development in pyrotechnic compositions for the US Army was carried out at Picatinny Arsenal, where the development of white light compositions proceeded along the following lines: 1) Mg metal was introduced in 1931 to replace part or all of the Al in order to obtain higher candlepower 2) Study of white light compositions in 1933 showed that a mixture of Ba and Sr nitrates was more efficient than the Ba salt alone or other oxidizing agents, such as KNO_3 , KClO_4 and NH_4ClO_4 . Furthermore, the addition of some Sr to the Ba salt overcame the greenish tinge obtained with the use of the Ba salt alone 3) Further work on white light compositions up to 1945 was concerned mainly with compositions for special tactical purposes such as ground signals, mortar illuminating shells,

flares with reduced smoke output, special airport flares and developing substitutes for critical material. The use of Mg in illuminating mixtures is also mentioned by Reilly (Ref 2)

Among the white pyrotechnic compositions used during WWII, the following may be cited:

White Flare Composition: $\text{Ba}(\text{NO}_3)_2$ 66, Al 26, sulfur 6, castor oil 2%. 500g of this powder loaded at 6,000 psi burns for 65 seconds, developing 60,000 candlepower

During WWII, the Germans developed several illuminating mixtures containing 14-28% of polyvinylchloride (either additionally chlorinated or not) together with 17-35% of magnesium powder, 50-61% of oxidizer and 1 to 5% of vaseline or synthetic wax (Ref 3)

Research conducted at Picatinny Arsenal has shown that for certain purposes yellow-tinted lights are preferable to white ones. Therefore, compositions containing sodium salts, such as sodium oxalate, were introduced, as for instance, in the following:

Yellow-tinted flare: $\text{Ba}(\text{NO}_3)_2$ 34, Mg (pre-coated with 6% linseed oil) 36, Al 8, Na oxalate 20, linseed oil 1, castor oil 1%. 300g of this composition pressed at 3,600 psi burned for 280 seconds and developed 556,000 candlepower

Faber (Ref 1, v 1, p 192) gives the following yellow light illuminating composition used by the French in WWI: Mg 67.9, Al (powder) 2.0, Na oxalate 17.4, KClO_3 2.6, sawdust 9.6 & shellac 0.5%

The use of sodium oxalate for yellow illuminating compositions was also recommended by Reilly (Ref 2)

Brock (Ref 6) claims that the luminosity of flares is increased by the addition of 1-5% MgO. For example a mixture consisting of Mg 50.0, NaNO_3 42.7, polyvinylacetate binder 4.5 & MgO 2.8% had a luminosity of 7.6×10^5 candlepower and a burning time of 2.24 secs

A detailed discussion of the theoretical aspects of illumination and the evaluation of several illuminating compositions is given by Tavernier (Ref 5)

Colored illuminating mixtures may also be used, but they do not produce light of such intensity as do white lights. Several new formulations were developed at Picatinny Arsenal before and after WWII

Some illuminating mixtures are listed in Chemical Abstracts, for example, L. Bohner, CA 32, 2754 (1938): German illuminating composition used in compressed form as a charge for "Very pistols" contained small amounts of cuprene in addition to the usual components, such as magnesium powder, barium nitrate and a binding agent such as shellac

G. J. Schladt, CA 33, 4426 (1939): Composition consisting of $\text{Ba}(\text{NO}_3)_2$ 36-40, $\text{Sr}(\text{NO}_3)_2$ 6-8, Mg (powder) 50-54%, coated with a mixture of linseed and castor oil

Another colored composition which is wickless and burns with a colored flame consists of: 100 part metaldehyde, at least 5 part AN, and at least 4 parts of a mixture of chlorates and nitrates of flame-coloring metals (Ref 5)

High luminous intensity & color purity produced by flames resulting from the combustion of Group II perchlorates mixed with alcohols or other org solvents was noted in a previous study made to adapt these mixes to markers & flares for aerial use. Tried to improve Marine MK2-0 Marker but concluded that no improvement is possible unless MK2-0 is redesigned (Ref 7)

Refs: 1) Faber, vols 1 & 2 2) J. Reilly, "Explosives, Matches & Fireworks," Van Nostrand, NY (1938), p 149 3) T. Urbanski, "Progress in the field of explosives during the past decade," Przemysl Chemiczny, 27, (IV), No 10, p 487 (1948) (Translated by Dr. Ivan Simon of Arthur D. Little, Inc) 4) Data on Foreign Explosives, PB 11544 5) P. Tavemier, MP 31, 309 (1949) & CA 46, 11686 (1952) 5) M. Wullschlegel-Hirschi, SwissP 319241 (1957) & CA 51, 15132 (1957) 6) J.A.M. Brock, USP 2968542 (1961) & CA 55, 14918 (1961) 7) R.M. Blunt, US Govt Res Develop Rep (1968) 68 (17) 142 & CA 70, 39425 (1969)

Illuminating Projectiles or Light Rockets (Star Shells). The star shells or light rockets, as used during WWI to light up the landscape and reveal the position of the enemy at night, consisted of a single star attached to a parachute. The illuminating composition consisted of 1 part powdered Al, Mg or Mg-Al alloy, mixed with 2 parts of oxidizing material such as $\text{Ba}(\text{NO}_3)_2$, NaNO_3 , KNO_3 and KClO_3 . Shellac or linseed oil was used as a binding material: oil reduced the

rate of burning. Sulfur was added sometimes to make the mixture easier to ignite. These mixtures were ignited by means of a charge of Black Powder (Ref 1)

It should be noted that Ba nitrate is preferable to K nitrate because the latter compound has a tendency to lower the temperature of combustion of the mixture

Some flares also had compositions similar to that of star shells

More recently, an illuminating compn for projectiles was prepd by compressing a mixture of pulverized Al/Mn alloy with basic Pb nitrate into a rigid coherent pellet. The pellet was inserted in the nose of a projectile (Ref 2) Refs: 1) Marshall, 2, (1917), p 609 & 3, (1932), p 196 2) W.H. Woodford et al, CanadP 394307 (1941) & CA 35, 2326 (1941) 3) Anon, "Military Pyrotechnic Series, Part I, Theory & Application," US Army Materiel Command Pamphlet AMCP 706-185 (April 1967), Chapter 6, Production of Light, pp 6-1 to 6-73

Image Converter Camera. See Encycl, Vol 2, p C14-R & article on High Speed Photography in this Vol

Imatrx. A Swedish explosive consisting of K chlorate of constant porosity which is impregnated with a combustible oil, such as petroleum, Diesel oil or Brennöl (d ca 0.8; bp 150-330°). Imatrx can be detonated by a blasting cap. Its temp of explosion is ca 3600°; Q_d 1163 kcal/kg, specific vol 450-490 l/kg; deton velocity 3000-4000 m/sec, expln temp 370° ("Temperatur-empfindlichkeit")

Ref: Dr. Langhans, Explosivst, 1962, 86

I. M. Filling. Jellied gasoline filling developed during WWII by Standard Oil Co and used for filling incendiary bombs: isobutyl methacrylate polymer 5.0, fatty acids, such as stearic acid, 2.5, naphthenic acid 2.5, aqueous solution (40%) of caustic soda 3.0, and gasoline 87

Ref: W. A. Noyes Jr, "Chemistry (Science in WWII)," Little, Brown & Co, Boston (1948), p 389

Imidazole or Glyoxaline and Derivatives. See 1,3-Diazole and Derivatives in Vol 5 of Encycl, pp D1165-R & D1166-L

2-Imidazolidone or Diazacyclopentanone-1.

See Ethyleneurea or Ethylenecarbamide in Vol 6, p E291-R

Imidazolines, Imidazolidines, Imidazolones, Imidazolidones; Their Derivatives and Nitrated Products. (Imidazolidine is also known as 1,3-Diazacyclopentane or Cyclotrimethylene-1,3-diamine)

These compounds, cyclic derivatives of urea or guanidine, are as follows:

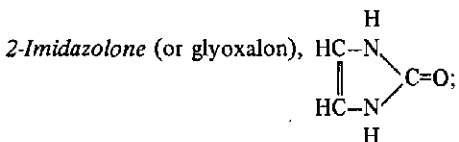
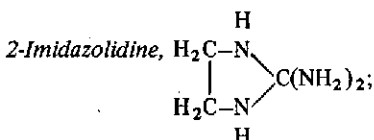
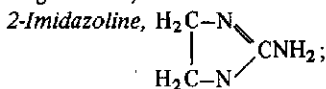

2-Imidazolidone (or imidiazolidinone or ethylene urea),

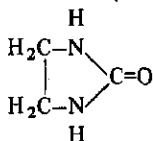

These compounds per se are non-explosive, but they can be nitrated to give explosive and/or thermally unstable nitramines

The following substances were prepared & studied by McKay & Wright (Ref 1) starting with the reaction of nitroguanidine with ethylenediamine to give **2-nitramino- Δ^2 -imidazoline** (Δ^2 is used to indicate that a double bond is attached at position 2):

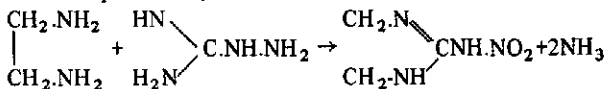

Nitration of this product with mixed nitric-sulfuric acid at -10° gave **1-nitro-2-nitramino- Δ^2 -imidazoline**,

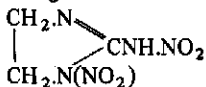

If the nitration is carried out with one equivalent of the nitric acid in acetic anhydride, the same product is obtained, but if nitric acid is used in excess, the so-called **1,3-dinitroimidazolidone**,

$\begin{array}{c} \text{CH}_2\text{.N}(\text{NO}_2) \\ | \\ \text{CH}_2\text{.N}(\text{NO}_2) \end{array} \begin{array}{l} \diagup \\ \diagdown \end{array} \text{CO}$, is obtained. It seems that the last reaction proceeds as follows:

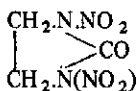
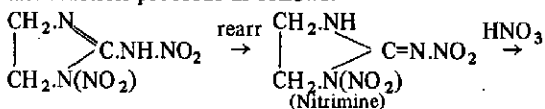

The **1-nitro-2-nitramino- Δ^2 -imidazoline** is an explosive comparable in brisance and power to RDX, but it is much more sensitive to impact. Its thermal stability is low, since 97% is destroyed by 5 minutes of boiling in water. When 1-nitro-2-nitraminoimidazoline is dissolved in cold aq ammonia and then acidified a stable product corresponding to the formula



is obtained. It is called **1-nitro-2-amino-2-nitraminoimidazolidine** (Ref 1). Some 2-imidazoline compounds were reported in Ref 2, and among them

1-Nitro-2-amino-2-imidazoline nitrate,

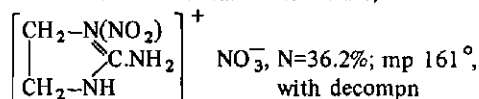

The **1-substituted-2-nitramino-2-imidazoline** derivatives were prep'd and investigated by McKay et al (Ref 3). Nitration of these products yielded **1-substituted-2-nitrimino-3-nitroimidazolidines**, which proved to be stable at room temperature. As examples of these compounds may be cited:

1- β -Nitroxyethyl-2-nitrimino-3-nitroimidazolidine,

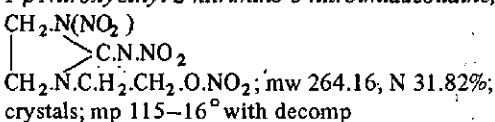

1-(N-Nitroguanyl)-N-nitro- β -aminoethyl)-2-nitrimino-3-nitroimidazolidine,

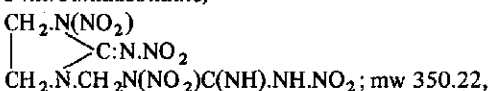

N 40.00%; mp 161–62° with decompn. McKay et al (Ref 3) do not mention that any of these materials are explosive

Other reactions of the *imidazolines* are described in Refs 4 & 5 and below

1-Nitroso-2-Iminoimidazolidine or 1-Nitroso-2-Imidazolidimone, mp 95–100° (with decomp) (Ref 6)

1,3-Dinitro-imidazolidine or 1,3-Dinitro-1,3-Diazacyclopentane,

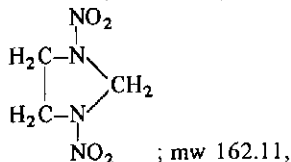

N34.56%, OB–49.4%; decomposes without ignition at 205°; ignites immediately when dropped on a 350° surface. It is explosive & is claimed to be about as impact sensitive as Tetryl (Figure of Insensitivity, FI, of 0.78). Its power is 136% PA. It is prepd by nitration of diendomethylene-tetraazacyclodecanemonohydrochloride,

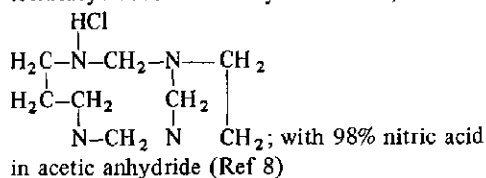

1,2-Dinitro-Iminoimidazolidine, Silver Salt. (No formula given). When 1,2-Dinitraminoimidazolidine,

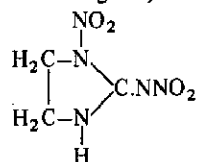

, is treated with aq alc AgNO_3 , its silver salt is precipitated. This salt exploded on a spatula over an open flame (Ref 7)

Refs: 1) A.F. McKay & G.F. Wright, JACS **70**, 3990–91 (1948) 2) A.F. McKay, J.E. Milk, JACS **72**, 1618 (1950) 3) A.F. McKay, J.R. Bryce & D.E. Rivington, CanadJChem **29**, 382–90 (1951) & CA **46**, 7094 (1952) 4) R.H. Hall, G.F. Wright, JACS **73**, 2208–13 (1951) & CA **46**, 1988 (1952) (Reactions of 1-nitro-2-nitramino-2-propylaminoimidazolidine with acetyl chloride) 5) R.H. Hall, G.F. Wright, JACS **73**, 2213–16 (1951) & CA **46**, 1989 (1952) (Reaction of 1-nitro-2-nitramino-2-proporyimidazolidine with acetyl chloride) 6) M.W. Kirkwood, JACS **76**, 1936 (1954) & CA **49**, 6927 (1955) 7) A.F. McKay et al,

JACS **76**, 6374 (1954) & CA **49**, 15861 (1955) 8) R.J.J. Simkins & G.F. Wright, JACS **77**, 3157 (1955) & CA **50**, 3496 (1956)

Imide. See Amides, Imides and Derivatives in Vol 1, pp A168–171 with the following additional entry: Two instances of explosions of ammoniacal Ag solns are described. Both are attributed to the formation and subsequent explosion of **Silver Imide**, Ag_2NH . In the first instance, a marking ink consisting of a mixt of solns of AgNO_3 , NH_4OH , Na_2CO_3 & gum arabic exploded on warming. In the second occurrence, Ag_2O was precipitated by NaOH from an AgNO_3 sp'm; The precipitate was washed, dissolved in NH_4OH , and a few drops of AgNO_3 soln were added until a permanent precipitate reappeared. This soln was then stored in tightly-stoppered dark bottles. Two such bottles exploded, one of them violently, after 10–14 days storage

Explosion is ascribed to the formation of Ag_2NH via:

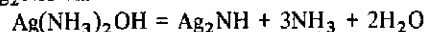

The silver imide, Ag_2NH , in its amorphous form is claimed to be very sensitive to heat & shock even when wet

Refs: 1) H. Vasbinder, PharmWeekblad **87**, 861 (1952) & CA **47**, 4083 (1953) 2) No other refs to explosion or decompn of *Imides* or *Imidic Acid & Derivs* were found in CA 1927–1971

Iminobisaceticazide or Iminodiaceticazide or Iminodiacetic Acid Diazide. See Diglycolamidic Diazide in Vol 5, p D1262

Iminodiethanol-dinitrate. See Di(2-nitroxyethyl)-nitramine or DINA in Vol 5, pp D1240–1242

Iminodihydropurines. See Aminopurines and Derivatives in Vol 1, p A154-L

3-Imino-5-phenylimino-1,2,4-triazoline (N^∞ -Phenyldihydroguanazol), $\text{C}_6\text{H}_5\text{N}:\text{C}=\text{NH}_2$;
 $\text{N}:\text{N}:\text{C}:\text{NH}$;

mw 173.18, N 40.44%; brownish-red powder, mp—explodes mildly at 138°. May be prepd from 3-imino-5-phenylimino-1,2,4-triazolidine
Ref: Beil 26, [120]

Iminosuccinylazidic Acid (Iminosuccin-Azidsäure in Ger),

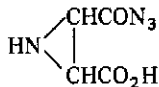

mw 156.10, N 35.89%, OB—51.3%; yellow ppt (from aq HCl). Prepd by dropwise addition of concd aq NaNO₂ to iminosuccinylhydrazidic acid dissolved in cold HCl. Explodes violently on heating
Refs: 1) Beil, not found 2) Th. Curtius & W. Dörr, JPrChem 125, 439 (1930) & CA 24, 3214 (1930)

2-Imino-1,3,4-thiadiazoline and Derivatives.

See Aminothiadiazole and Derivatives in Vol 1, p A262–263

2-Iminothiazoline and Derivatives. See Amino-thiazole and Derivatives in Vol 1, pp A263–265 and the additional entry below:

Nitrosiminothiazoline. $\begin{matrix} \text{HC}-\text{S}-\text{C}=\text{NNO} \\ || \quad | \\ \text{HC}-\text{NH} \end{matrix}$; mw

129.14, N 32.54%; orange-red amorphous powder; explodes ca 140° & decomp on storage in moist atm; insol in water; sol in alc or eth. Prepd by reacting aminothiazole with NaNO₂ in HNO₃
Ref: Beil 27, 155

5-Imino-1,2,3,4-thiotriazoline. See 5-Amino-1,2,3,4-thiotriazole in Vol 1, p A164-R

5-Imino-2-thion-1,3,4-thiodiazolidine. See 5-Amino, 2-mercapto-1,3,4-thiodiazole in Vol 1, p A224-L

IMP. Initial Maximum Pressure (in rockets) is the value of the pressure when it reaches a steady state. See Fig under IASP in this Vol
Ref: F. Bellinger et al, IEC 38, 166-67 (1946)

IMPACT, INITIATION OF EXPLOSION BY Introduction

It is common knowledge that a blow (impact) can initiate explosion in certain substances usually referred to as explosives. Aside from superficial statements, such as the one above, the subject of impact initiation (also called impact sensitivity) of explosives has been shrouded in myth, confusion & misinformation. Until recently, more time & money has been invested, with less return on the investment, in studying impact sensitivity than any other aspects of explosion sensitivity. This was most aptly stated in the following quotation (Ref 4)

"It is now becoming more widely recognized that most of the standard impact and friction methods of measuring the 'sensitivity' of an explosion have little physical significance. This is fair enough: hitting a solid with a hammer or rubbing it with a piece of sandpaper is perhaps an experiment more proper to a carpenter than to a physicist"

F. P. Bowden, F.R.S.

Even the concept of *impact sensitivity* as a specific property of an explosive is questioned in a recent publication (Ref 17), at least for the response of confined explosive samples to impact

Nevertheless, examination of the response of explosives to more or less controlled impacts did provide qualitative information about the safety of handling these explosives. There is no question that Lead Azide is *much more impact sensitive* than TNT, and that TNT is much safer to handle than Lead Azide. It is the quantitative meaning of the "*much more*" that creates confusion and indeed it may have no quantitative meaning at all. Presumably some of the immense effort devoted in past years to impact testing is excusable because it was based on the fond hope (unfortunately unrealized) of finding the ideal explosive—one that is powerful but "*insensitive*"

We have thus far avoided distinguishing between impact sensitivity, projectile (or bullet) sensitivity and shock sensitivity which also involve impact loading of the test explosive. Shock sensitivity, as the name implies, is the response of an explosive to an externally generated shock. Measurements of shock sensitivity are very reproducible, although many existing measure-

ment techniques only measure the shock sensitivity of a material in the particular environment of the test, ie the measured "sensitivity" is not an absolute quantity. The characteristic time scale of a shock sensitivity test is of the order of $1\mu\text{sec}$ and peak stresses in the test sample are of the order a few kilobars to several tens of kilobars. Characteristic response times in a falling weight impact test are at least two orders of magnitude greater than in the shock sensitivity test, while peak stresses, in condensed media, are at least two orders of magnitude less. Typical test results are anything but reproducible. Bullet sensitivity tests have times & stresses that lie between shock & impact test values. Generally, reproducibility is rather poor so that in this respect bullet sensitivity resembles impact sensitivity more closely than it does shock sensitivity. For a discussion of bullet sensitivity, see "Bullet Tests" in Vol 2, pp B332-340

In what follows we will describe some *impact machines* and *impact tests*, ie the apparatus and methods for "measuring" *impact sensitivity*. We will then present and discuss *impact sensitivity* data for common explosives obtained with these machines by different laboratories. Then we will briefly consider how impact sensitivity tests have contributed to the development of the theory of initiation of explosives. Finally, we will examine impact testing from a theoretical point of view

Impact Machines and Impact Tests. One frequently hears the remark that there are as many types of impact machines as there are explosives test laboratories. This is somewhat misleading. In reality, all laboratories use essentially similar equipment but test procedures, and test data analyses differ. Basically an impact machine is an apparatus that drops a steel weight from a pre-determined height onto a plunger or striker resting on top of the test sample which is placed on a steel anvil

Procedural differences among laboratories consist mainly in different methods of confining the explosive sample subjected to impact. In some laboratories the explosive is simply spread as a thin layer between striker & anvil. In other laboratories fine sandpaper is placed under the explosive layer. Sometimes the explosive is confined in a small steel cup and

the bottom end of the striker is shaped to fit snugly into the open end of the cup. In some tests a brass sleeve is placed under the striker & over the test sample contained in a cup

Different laboratories use different criteria for determining whether a drop-test resulted in an explosion ("go") or failure ("no-go"). In many test facilities any visual observation of smoke, flash or flame, or any crackle, pop or bang detected by the operator is taken to signify a "go" result. Sometimes sound-meters are used to detect the audible signals of a drop test. In still more elaborate tests, the volume of gas, produced by a "go" result, is measured. In general, for "sensitive" explosives like PETN, distinguishing between "go" & "no-go" is quite easy. For "insensitive" explosives like TNT, this distinction becomes much more difficult, and it is for these "insensitive" materials that operator judgment becomes unreliable and instrumental judgment devices become a necessity

Most test procedures are designed to obtain the so-called 50% height, ie the height of drop for which 1/2 the trials are "go" and 1/2 the trials are "no-go." The so-called "Bruceton" or "up and down" or "stair-case" test is an efficient method of obtaining 50% heights. In this method, if the first trial is a "go" the next trial (using a fresh explosive sample) is made at a pre-determined drop height that is lower than the height of the first trial. Drop heights are lowered in pre-determined steps (using a fresh sample for each trial) until a "no-go" is observed. Now the drop height is increased to that of the last trial before the "no-go." If this trial is a "go" the drop is again decreased in steps until a "no-go" is observed. If it is "no-go" then the drop height is increased in steps until a "go" is observed. This scheme, of increasing the drop height after a "no-go" & decreasing it after a "go," is continued until 20 or 25 drops are made. Statistical methods of choosing the drop height steps and analyzing the test data have been carefully worked out by Dixon & Mood (Ref 1). A concise description of test procedure and analysis of results is found in Ref 5

The Bruceton test (as expected) gives a good value of the mean drop height, ie 50%

height, but σ the std deviation of this mean, derived by statistical methods, often disagrees with observations, ie observed "go's" and "no-go's" frequently lie outside a 2σ limit around the 50% height. Martin & Saunders used computer simulation of the Bruceton test to assess its statistical validity (Ref 8). Their computer runs could produce the equivalent of 200,000 drop tests and thus provided a good check of the large sample theory on which the theory of the Bruceton test is based (although in practice Bruceton sample size is far from "large"). Martin & Saunders conclude that a Bruceton test of 25 samples yields a good estimate of the 50% height but a poor estimate of its std deviation. To get a good estimate of the latter the minimum test sample size should be 100 samples. They also conclude that test height increments, ie the increase or decrease in drop height after a "no-go" & after a "go" should be equal to about 2σ . In practice this means that one needs some estimate of σ before making the test in order to select the best height increments

The Bruceton method is also frequently used in other destructive tests, eg in functioning tests of detonators, gap tests for shock sensitivity, or in tests where the test alters a sample so that it is no longer in its original state

Brief mention of impact machines is made under "Physical Tests" in Vol 1, p XVII. Because there are many literature references to the following impact machines, and not because they are inherently better than any others, we will now describe the following: Explosives Research Laboratory (ERL), Rotter, Bureau of Mines (BOM) & Picatinny Arsenal (PicnArsn)

The ERL machine is used at LASL, LLL & NOL. A detailed view of the striker-anvil region of an ERL machine is shown in Fig 1 & an overall view in Fig 2

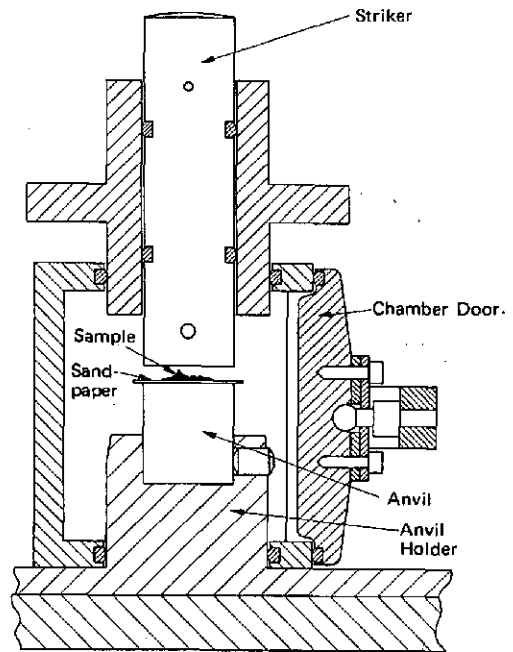

Fig 1. Anvil Striker Arrangement, ERL Machine

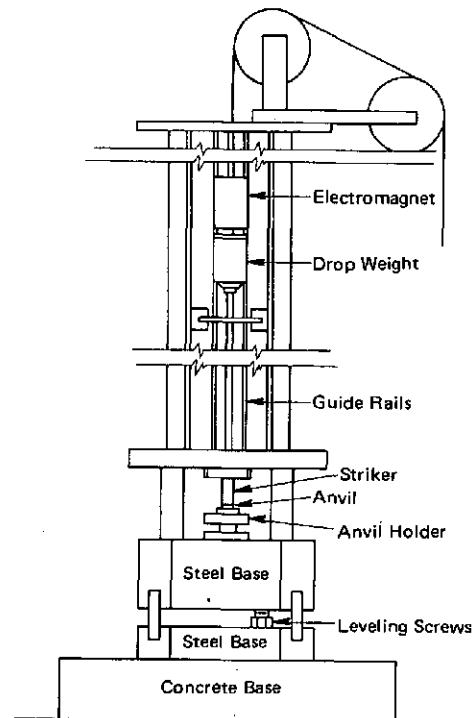

Fig 2. Drop Weight Impact Machine, ERL Model, type 12 tools

It is claimed that the sandpaper under the explosive sample tends to minimize the effects due to variation in surface roughness of striker & anvil (Ref 9). However, it was also claimed (Ref 10) that sandpaper tends to cushion impact & give misleading results for very "sensitive" explosives like the azides. The Bruce-ton method, usually involving 25 drops, is used at LASL, LLL & NOL. Samples are 30-40 mg and are usually unconfined, though LASL places them in a dimple in the sandpaper (Ref 11). LASL & NOL use a 2-5kg falling weight, but LLL appears to be using a 5kg weight (Ref 18). Microphones and/or pressure transducers are used to aid the operator in his judgment between "go" and "no-go" results for "insensitive" explosives

The Rotter apparatus as used at AWRE is shown in Fig 3

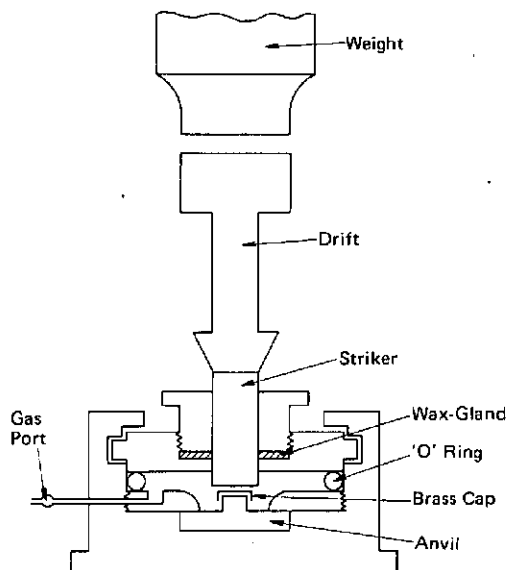

Fig 3. Rotter Machine Impact Chamber and Anvil-Striker Arrangement (not to scale)

A 40mg sample is placed on a brass cap which is inverted over the anvil. The falling weight is normally 5kg. If the volume of gas evolved by a 0.03mg sample is more than 1ml, then the test is considered a "go." The Bruce-ton method is used and results are reported as *Figure of Insensitiveness* or *FI* which is ob-

tained by dividing the measured 50% height by the 50% height for a standard RDX sample and multiplying this ratio by 80 (Ref 12). It has been claimed that the volume of gas evolved can be related to the ease of propagation of explosion thru the test explosive. Hornby (Ref 13) presents data that show that increase in drop height (above the 50% height) has little effect on the amount of gas evolved by RDX or by 60/40/1 RDX/TNT/wax. For pure RDX gas evolution is always (with considerable variation) large (16ml). For the RDX mixture gas evolution is always small (1-2ml). This is interpreted to mean that explosion, once initiated, propagates readily in pure RDX but not in RDX/TNT/wax. For Picric Acid gas evolution increases with increasing drop height. According to Wilby, this shows that explosion in PA propagates more readily as impact energy input is increased

Figure 4 shows a sketch of BOM machine with samples placed in confining cups. This

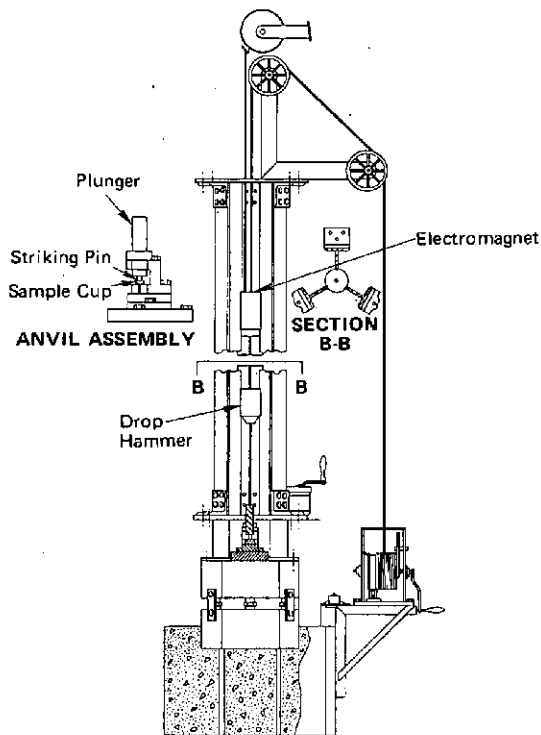

Fig 4. Impact Apparatus Showing Anvil-striking Pin Assembly

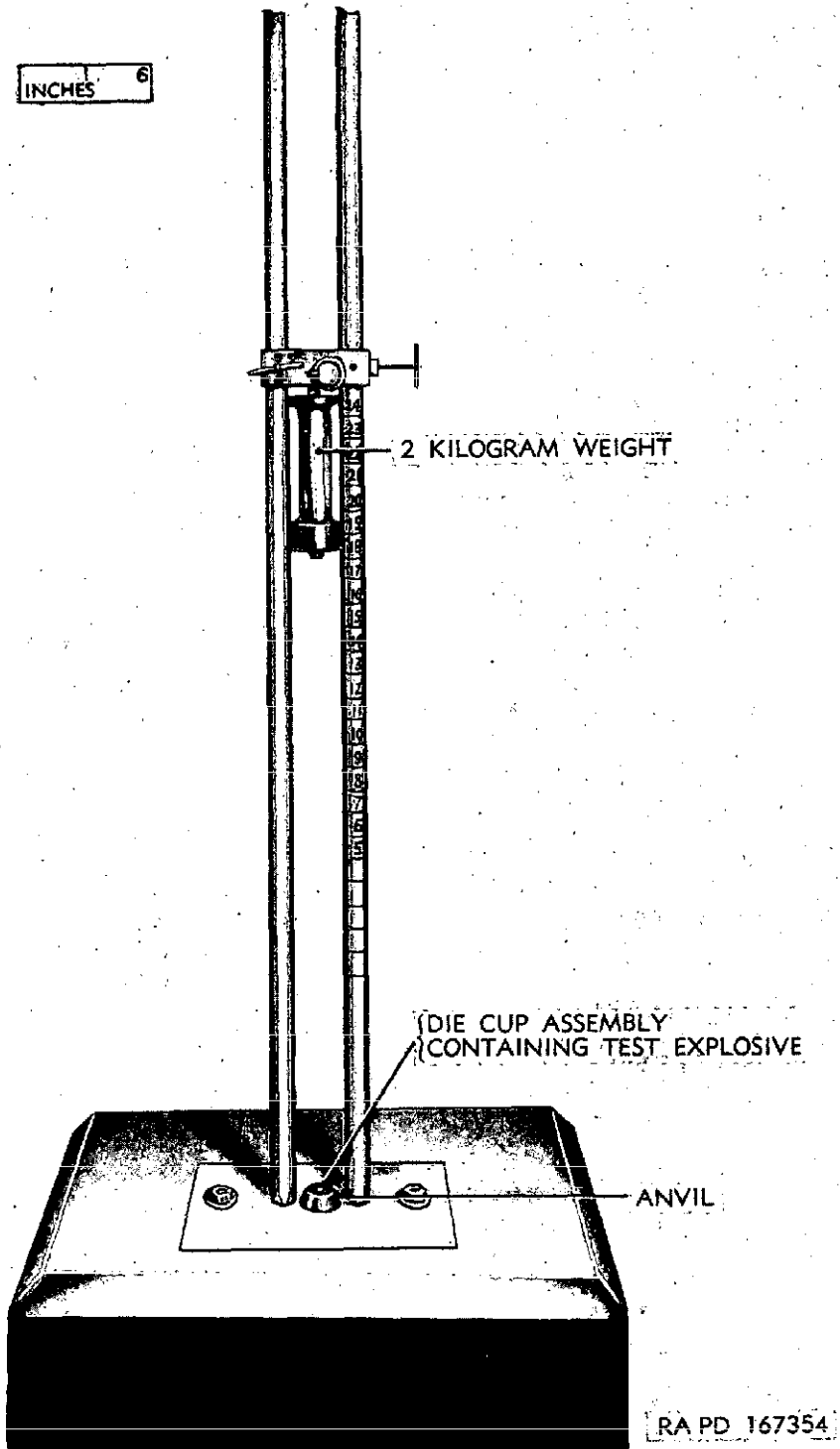

Fig 5-1. Picatinny Arsenal Impact Test Apparatus

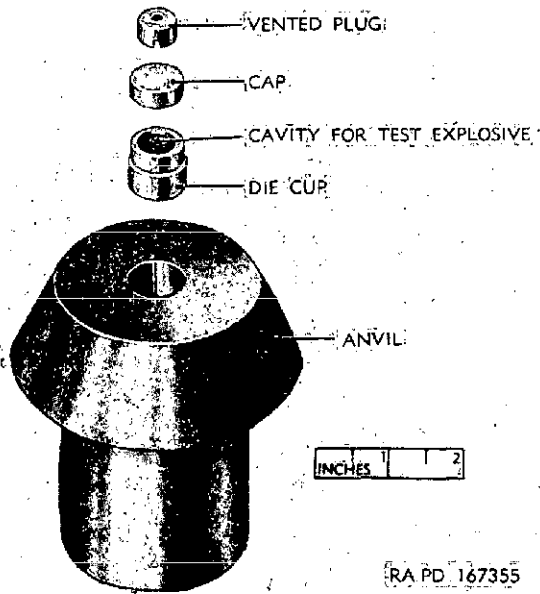

Fig 5-2. Parts of Picatinny Arsenal Impact Test Apparatus

machine is also used with samples spread between sandblasted anvil & striker surfaces. Drop weights vary from 5kg to 1kg but 2kg appears to be the weight most frequently used. The writer's experience with BOM machines is that they are no better or no worse than the other types—at least for “sensitive” and “moderately sensitive” explosives

A schematic diagram for the **Picatinny Arsenal Machine** is shown in Fig 5. The test sample is poured into a hardened steel cup and cup & sample are weighed. This weighing, together with a previous weighing of empty cup, gives the test sample weight. A brass cover is then pressed over the cup and the covered cup is positioned in a recess in the anvil. A vented plug is placed on top & in the center of the brass cover. The falling weight (2kg, 1kg & 1 lb weights are used) impacts the vented plug. The test is begun with a 12-inch drop. If an explosion is observed, drop heights are lowered in 2-inch steps until failure occurs. New sample assemblies are used for each drop. If the initial drop results in a failure, drop heights are increased in 4-inch steps until an explosion is observed. These preliminary tests are used to

“zero-in” on the minimum drop height at which at least one “go” is observed in 10 drops (with fresh samples for every drop). One inch below this height no explosions should be observed in 10 drops. It is claimed that this machine is particularly suitable for impact-testing of “insensitive” military explosives such as TNT & Ammonium Picrate (Ref 16)

In addition to the impact machines just described, the search for a “perfect” impact machine has resulted in the development of many designs, most of which are not very different from each other, but are claimed to be “improvements in the state of the art” by their inventors. Below we list, in chronological order, references to and very brief descriptions of some of these machines

C.E. Bichel “Fallapparat zur Bestimmung der Empfindlichkeit gegen Schlag und Stoss,” *SS* 3, 407 (1908)

W. J. Williams, “Impact Tests with the Drop-hammer Method of Kast,” *JFranklinInst* 169, 143 (1910)

Anon, “BOM Small Impact Machine,” *IEC* 25, 665 (1933)

C. Hahn “An Improved Falling Weight Apparatus,” *ArchPharmChem* (Copenhagen) 55, 259 (1948) & *CA* 42, 6113 (1948)

W. J. Powell et al, “Ball and Disk Impact Machine,” *TransRoySoc* A241, 287 (1948)

N.R.S. Hollies et al, “Newly Designed Impact Sensitivity Apparatus,” *CanJChem* 31, 746 (1953) & *CA* 48, 1683 (1954)

P. Braid & R. Langille, “A New Type of Impact Machine,” *CanJTech* 33, 228 (1955) & *CA* 49 (1955)

R. C. Kopiuk describes an apparatus very similar to the PicArsn machine, *ASTM Bulletin* No 250, 51 (1960)

C. M. Ball, “A Colliding Ball HE Impact Sensitivity Testing Machine,” 3rd ONR Symp on Deton (1960), vol 1, p 1

N. A. Kholevo, “Description of Type 1, 2 & 3 Machines,” in *Theory of Explosives* (transl from Russ *Teoriya Vzryvchatykh Veschestv*) K. K. Andreyev et al, editors, *FTD-MT* 63-254, p 8 (1963)

Note: Development of these machines was actually begun in 1946.

Impact Sensitivity Data. In view of the preceding section & the discussion to be presented in the next section, preparing tables of impact sensitivity data for various explosives (even for the common ones) is an exercise in futility. Reported results from different test facilities whether they are for 50 heights or no explosion in 10 trials, etc and whether the impact stimulus is reported as fall height, fall impulse or fall energy, just *do not agree*. When internal "standards" are used and results are reported as *Figures of Insensitivity* or *FI* chances of qualitative agreement among test facilities are improved but quantitative agreement is rare. About the best one can hope for is a qualitative ordering of impact sensitivity, ie statements like: Lead Azide is more sensitive than RDX which is more sensitive than TNT

The following Tables of Impact Sensitivity data serve to justify the above statements:

Table 1 shows quantitative accord between NOL & LASL (they use the same type of equipment & test procedure), and some agreement between NOL, LASL & Picn Arsn for sensitive & moderately sensitive explosives such as PETN, RDX & HMX. The BOM 50% heights for explosives more sensitive than TNT are much larger than those of the other facilities. The Rotter data (Table 2) gives 50% heights that are even larger than the BOM data. Thus Tables 1 & 2 show that quantitative agreement of impact data among different laboratories is rare

TABLE 2 (Ref 12)
Impact Sensitivity Data Obtained with
the Rotter Apparatus at ARDE
(5kg falling weight & 30mg samples)

Explosive	Median Ht (cms)	Figure of Insensitive- ness
Sulphurless Gunpowder	253	194
TNT	197	152
Plastic explosive	197	152
RDX/TNT/Al/BWX, 41.5/40/8/0.5	190	146
RDX/TNT/Wax, 60/40/1	152	117
RDX/TNT, 60/40	137	105
RDX/Wax, 91/9	127	98
Octol		94
Gunpowder	117	90
Tetryl (CE)	112	86
RDX, Standard	104	80
RDX, Military Grade	98	75
HMX	73	56
PETN	66	51
Lead Azide*	113	20
Lead Styphnate*	69	12
Lead 2:4 dinitro-resorcinate*	61	11

* These explosives were tested with a 2kg weight, and Lead 2:4 dinitro-resorcinate was used as the standard for comparison with an FI of 11

TABLE 1 (Ref 14)
Comparison of Impact Sensitiveness Tests (Powdered Samples)

	NOL*		LASL*		BuMines ERL 50% Pt	PA (BuMines) 10% Pt**	PA Apparatus 10% Pt**
	50% Pt		50% Pt				
	cm	σ	cm	σ	cm	cm	in
Lead Azide	4	0.12	—	—	—	17	5
PETN	12	0.13	12	0.05	43	17	6
RDX	24	0.11	22	0.01	79	32	8
HMX	26	0.10	26	0.02	—	32	9
Tetryl	38	0.07	42	0.02	94	26	8
Comp B	60	0.13	59	0.02	—	75	14
TNT	157	0.10	154	0.03	183	98	15
Explosive D	254	0.05	190	—	—	—	17

* σ is the std deviation of the 50% height

** This is really the height at which at least one explosion was observed in 10 trials. One inch below this height there were no explosions in 10 trials

TABLE 3
Comparison of Impact Sensitivity Tests
on the Basis of Figures of Insensitivity, FI
FI*

Explosive	ARDE (Rotter Test)	NOL (ERL Test)	LASL (ERL Test)	Picn Arsn (PA Test)	LLL (ERL Test)
Explosive D	—	850	690	170	—
TNT	152	522	560	150	228
Comp A-3	98	195	~ 250	160	—
Comp B	117	200	214	140	128
75/25 Octol	94	—	138	170	116
75/25 Cydotol	—	—	132	≤ 140	95
Tetryl	86	126	153	80	80
HMX	56	87	95	90	94
RDX (used as Std)	80	80	80	80	80
PETN	51	40	44	50	31
Lead Azide	20	5	—	50	—

*ARDE values from Table 2; NOL, LASL & Picn Arsn values computed by us from the data of Table 1; LLL values computed by us from the data in Ref 18

One might suspect that use of an internal standard might bring better agreement. Consequently, in Table 3, we have used ARDE's definition of *Figure of Insensitivity, FI*, to arrange the data of Tables 1 & 2 on a common basis. As seen in Table 3, this procedure does not bring all the results into agreement. Differences in FI appear to be greatest for the least sensitive & most sensitive explosives

Now even if we abandon all attempts at getting quantitative accord, and merely attempt a qualitative ranking of explosives, ie Expl A is more sensitive than Expl B etc, we still find disagreements. As shown in Table 4 there are reversals in sensitivity rankings for RDX, HMX & Tetryl, and Comp B, Comp A-3 & TNT

To some degree the variation in impact sensitivity data among different test facilities can be attributed to differences in: drop weights (some laboratories use 5kg weights, others 2kg weights etc), in test sample weights, in sample confinement, impact surface roughness, methods of analyzing the data, etc. However when the effects of these variables are examined in any one laboratory, it is generally found that these effects are relatively small, and certainly not large enough to explain the large differences in 50% heights or even FI's obtained by different laboratories for the same series of explosives

TABLE 4
Qualitative Ranking of the Impact Sensitivity
of Common Explosives
(Based on FI data of Table 3)
Ranking (a)

Explosive	ARDE	Picn Arsn	LLL	LASL	NOL
Lead Azide	1	1 (b)	—	—	1
PETN	2	2	2 (c)	2 (c)	2
RDX	4	3	3	3	3
HMX	3	5	5	4	4
Tetryl	5	3 (d)	3 (d)	6	5
Octol	6	9 (f)	6	5	—
Comp B	8	6	7	7	7
Comp A-3	7	8	—	8	6
TNT	9	7	9 (e)	9	8
Explosive D	—	9	—	10	9

- (a) 1 is the most "sensitive" and 9 is the least "sensitive" explosive
 (b) FI values make it appear much less impact-sensitive relative to PETN than FI values from other facilities
 (c) Assuming that LA would have had lower FI value had it been tested
 (d) Same FI as for RDX
 (e) Assuming that Comp A-3 is more sensitive than TNT
 (f) Same FI as Expl D

It might appear then that impact testing is a complete exercise in futility and should be abandoned. This is definitely the wrong conclusion. Impact "sensitivity" properly interpreted has its uses. This is aptly stated by Hornig (Ref 14):

"Sensitiveness measurements should be considered as dimensionless, although we often do give units to them. The numbers gain their significance only by comparison. Fortunately, we have today a considerable storehouse of experience in the handling and use of a large number of explosives and explosive compositions. We also have laboratory measurements of their sensitiveness. When a new compound or composition is tested, its standing can be compared with the known explosives and the new one can be categorized as being similar to one of the old ones. This gives a reasonable knowledge of the degree of hazard faced"

Theoretical Considerations. In the preceding sections we have been rather negative about impact testing of explosives. We have stressed the great variability of impact data and the lack of a quantitative characterization of impact sensitivity. Yet impact testing has triggered important developments in the theory of initiation of explosives. The classic work of Bowden & his school on this subject is summarized in two excellent monographs (Refs 2 & 3) and in a more recent publication (Ref 15). However the *hot spot* theory, so successfully championed by Bowden, cannot explain all the strange and apparently contradictory effects observed in impact testing of explosives. Some of these weird phenomena led Kholevo (Ref 6) and later Bobolev et al (Ref 17) to develop a rather different theory of impact initiation than that of Bowden. We will now examine both of these theories in some detail

Much of Bowden's theory has already been described under *Hot Spots* in this Volume (we shall henceforth refer to this as Ref 19). Briefly what Bowden proposed was that most impact initiations are produced by very localized regions of high temperature i.e. *hot spots*. He showed that a falling weight impacting an explosive sample can generate hot spots in the following ways: a) by adiabatically compressing air (or vapor of the test explosive if impacts are made at sub-atmospheric pressure or at elevated temperatures)

bubbles trapped in or purposely introduced into the explosive sample; b) by intercrystalline friction (for high-melting explosives); c) by friction of the impacting surfaces; e) by plastic deformation of a sharply-pointed impacting surface; f) by viscous heating of the impacted material as it flows past the periphery of the impacting surfaces—appreciable heating in this case is claimed to occur only for quite energetic impacts

The many mechanisms of generating hot spots, coupled with complex nature of the development of a hot spot into an explosion (see Ref 19) or the decay of a hot spot without explosion, offer a convincing explanation for the observed variability of impact test results. Thus, in test method a), hot spot formation via adiabatic compression may be dominant. In test method b), viscous heating may be the main mechanism for heat generation. In test method c), conditions may favor rapid quenching of hot spots, and so forth. Even with a given test method several hot spot generating mechanisms may be operative and these can then develop into explosion by different paths. Consequently even slight changes in procedure or conditions may produce quite drastic changes in impact test results

Some of the quantitative consequences of hot spot theory were presented in Ref 19. A qualitative discussion of heat flow in a compressed gas bubble hot spot was also presented in Ref 19. The necessity of having enough, but not too much, liquid or solid spray or foam within a compressed gas bubble (in order to have sufficient heat flow from the bubble to the surrounding condensed explosive) provides another hard-to-control variable in impact testing and thus increases the variability of test results

Until now we have studiously avoided defining what constitutes an explosion or "go" result in an impact test, except mentioning that "go's" are judged on the basis of sound, flash, gas volume etc. What physical events produce these observed manifestations? Based primarily on the studies of Bowden (Ref 2) it is clear that in an impact test "explosion" frequently starts as a relatively mild deflagration which can propagate as slowly as 10m/sec, which turns into a much more violent deflagration, (100-1000m/sec), in the confined (by striker & anvil) explosive. For many "insensitive" explo-

sives this is all that occurs. For the more "sensitive" explosives (PETN, RDX) the fast deflagration stage is followed by a true detonation. The only known exceptions to the sequence of deflagration-detonation are the heavy-metal azides. For Lead & Silver Azides impact creates either a full-blown detonation (no deflagration stage) or a failure (Ref 2)

During impact the explosive sample is at an elevated pressure, and the initial deflagration of the sample consequently occurs at elevated pressures. As pointed out by Andreev (Ref 7), the critical thickness for the deflagration of secondary explosives is much greater than the usual sample thickness in an impact test. Since the critical thickness decreases as ambient pressure increases, impact not only generates the heat required to initiate deflagration but also provides the necessary pressure for the deflagration. Highly localized "explosion" upon impact can be the result of too rapid a pressure drop in the impact system. Thus, deflagration may die out if the pressure in the system becomes too low (approaches atmospheric). These considerations re-emphasize the difficulty or even impossibility of separating the effects of *initiation* and *propagation* in an impact-generated explosion

A rather different view of impact initiation to that of Bowden et al, is presented by the Russian school. The originator of this school appears to be Kholevo (Ref 6), supported by Andreev (Ref 7), with a recent and detailed presentation of this point of view provided by Afanas'ev & Bobolev (Ref 17) (from now on we will refer to these writers as A & B without listing the Ref). Briefly stated, A & B consider that the prime mechanism of hot spot generation in solid explosives is by inelastic deformation of the entire impacted explosive sample (Kholevo (Ref 6) calls this "flow")

To understand what follows we must briefly digress and describe three impact machines constantly alluded to in the Russian literature—the so-called Kholevo No 1, No 2 & No 3. Kholevo No 1 is quite similar to Kast's impact machine (see section on Impact Machines). The explosive sample is placed between a striker & an anvil which are contained within a sleeve. Since striker & anvil fit rather loosely into the sleeve there is a small air gap into which the explosive

may be extruded by impact. Kholevo No 2 has no sleeve and the sample can "flow" or deform unimpeded upon impact. Kholevo No 3 is essentially the same as No 1 except that there is a very tight fit between striker/anvil & sleeve. If the sample is spread uniformly over the entire striker-anvil contact area, sample deformation is totally impeded in Kholevo No 3

Unfortunately, the translation of A & B's book is rather uneven and it is difficult to capture all of the finer details of their presentation. Moreover their presentation is somewhat diffuse and lacks a good summary. Below we will summarize the main thrust of A & B's ideas and then select (from various portions of A & B's book) supporting evidence for these ideas

Summary: 1) Impact Initiation is a thermal process that occurs heterogeneously at localized regions of high temperature—hot spots

2) As usual, the impact initiation process is divided into two stages; in the first stage part of the explosive is heated to a critical temperature and in the second stage these heated regions self-ignite

The actual impact (at fall hammer velocities of 1-5 m/sec) can be considered as a pseudo-static process, i.e. the rate of loading is much slower than the sound velocity in either the apparatus or the compacted explosive sample

3) The maximum hot spot temperature is limited by the melting point of the impacted medium, *but* this is the *melting point at the elevated pressure of the impact* and not the ordinary melting point at one atmosphere

4) A necessary *but not sufficient* condition for initiation by impact is that impact pressure (stress) be sufficiently high so that the melting point of the explosive is raised above some critical temperature, T_{CR} . For $T \geq T_{CR}$ the explosive, in the hot spot, will decompose adiabatically in times of the order 10μsec, which has been observed experimentally. The relation between T_{CR} & the critical stress is then expressed by:

$$P_{CR} = (T_{CR} - T_m) / \alpha \quad (1)$$

where P_{CR} is the max critical stress generated in the explosive by the impact and T_m is the melting point of the explosive at one atmosphere. This relation is based on the assumption that

$$T_m(P) = T_m + \alpha P \quad (1a)$$

where α is a constant which, according to Ref 4a, has the approximate value of $0.02^\circ\text{C}/\text{atmosphere}$ for all explosives. For most of the common high explosives $400 \leq T_{cr} \leq 600^\circ\text{C}$ and the corresponding P_{cr} is then $\approx 10\text{kbar}$. Furthermore, the hot spot radius for these explosives is of the order of 10^{-4}cm . It must be emphasized that Eq 1 says nothing about how the hot spot is created. All it says is that impact must generate a stress in the explosive at least equal to P_{cr} or $P_{\text{impact}} \geq P_{cr}$. This criticality condition could be satisfied by slow *hydrostatic compression* of the sample under circumstances where *explosion is known not to occur*

5) If, as stated above, $P_{cr} \approx 10\text{kbar}$, then the question arises how stresses of this magnitude can be generated by impact in explosive compacts whose compressive strengths are about 100 fold less than P_{cr} . For unconfined explosive compacts (in Kholevo No 2) this can only occur with "thin" explosive compacts, ie with explosive layers whose $h/D \ll 1$ where h & D are explosive thickness & diameter. The relation between, σ_u , the ultimate compressive strength of the explosive compact & the average stress, \bar{P}_u , at which the compact fails via brittle fracture (in compression) is:

$$\bar{P}_u = \sigma_u(1 + D/3\sqrt{3}h) \quad (2)$$

The stress varies over the sample (compact) surface such that the peak stress is (2 to 2.5) \bar{P} at the center and $\sigma_u/3$ at the periphery (where \bar{P} is the average stress on the sample). Since $P_{cr} \gg \sigma_u$ for most explosives, and the criticality condition is $P > P_{cr}$, effective hot spots cannot form near the sample periphery. Effective hot spots are also not generated at the center of the sample because inelastic deformation of the sample is a minimum near its center. As will be shown, A & B claim that non-uniform inelastic deformation of the entire sample generates hot spots

Because of the variation in stress over the sample, A & B relate all stress effects to \bar{P} the average stress. Now if we assume that there exists an average critical stress \bar{P}_{cr} , above which explosions occur, and that it lies on the \bar{P}_u vs h (or h/D if D varies) plot of Eq 2, then

$$\bar{P}_{cr} = \sigma_u(1 + D/3\sqrt{3}h_{cr}) \quad (2a)$$

defines a critical thickness h_{cr} . This critical thickness is a specific property of the explosive if the impact is made on unconfined explosive samples (ie in Kholevo No 2 type impact machines) with a striker of fixed diameter

According to Eqs 2 & 2a, one should present experimental data in the form of plots of \bar{P} vs h/D or h (if D is a fixed sample diameter). This will be done in a following section

6) We will now present a summary of A & B's description of the processes that generate hot spots in impacted layers of explosive. The processes are complex but fortunately rather drastic simplifications lead to conclusions that are in accord with experimental results. In considering non-isothermal shear on plastic bodies, A & B conclude that this shear will result in a discontinuity in the straining rate and consequently in heat generation by the transformation of elastic energy stored in the sample into deformation work at the shear plane. These processes are always localized and continue spontaneously until all the stored elastic energy (and the kinetic energy of relative motion, along the shear plane, of the upper & lower portions of the sample) of the sample is used up. If there is sufficient energy for portions of the sample (along the shear plane) to melt the process continues as deformation work of the viscous layer. When the rapidly-deforming liquid phase is created, heat transfer in it occurs via convection and is more rapid than heat transfer in the solid which is by conduction. Thus the liquid phase tends to stay at temperatures that are near the melting point (at that pressure) because of rapid heat losses particularly to any solid material dispersed within the liquid. Some of this solid material will melt and absorb energy thereby (heat of fusion). This model is obviously in accord with Eq 1 which states that the critical temperature is the temperature of melting at P_{cr}

A & B also present arguments that indicate that inhomogeneities in the solid, unless they are as large as 0.1mm, do not affect the heating mechanism. They also argue that Kholevo's original viscoplastic model (Ref 6) is unrealistic and that their model of a brittle body is closer to reality

7) Thus far we have presented A & B's ideas

on the initiation of solid explosives by impact. In the real world initiation and propagation are very difficult to separate. Consequently any experimental measurement of "impact sensitivity" will depend on the processes that control *initiation and propagation under the particular conditions of the measurement*. A & B point out that the deformation and fracture of the solid explosive, which creates the hot spots required for initiation, may also aid transition to detonation because the deflagration started by the hot spots propagates into regions of greater surface area (fractured regions) where it will accelerate. Unless some quenching mechanisms are also present, the accelerating deflagration will eventually become a stable detonation

Based on an analysis of the penetration of a *thick*, rigid plastic body by a rigid cylinder (whose radius is smaller than the radius of the body), A & B arrive at

$$\frac{P_{cr}}{\sigma_u} \leq 3 \text{ to } 4.8 \quad (3)$$

and empirically

$$P_{cr} \approx 2\bar{P}_{cr} \quad (4)$$

Since the force F on a sample is $\pi/4PD^2$, the minimum force for initiation is:

$$F_m = \pi/4P_{cr}D_m^2 = (3-4.8)\pi/4\sigma_u D_m^2 \quad (5)$$

where the minimum sample diameter, D_m , must satisfy the conditions required for propagating detonation in the particular *thick* explosive sample. The obvious condition is that

$$D_m = d_{cr} \quad (6)$$

where the d_{cr} is the critical detonation diameter, ie the diameter below which detonation will not propagate no matter how it is initiated. Moreover a further limitation is that D_m must exceed some limiting dimension a_1 which is required for the generation of hot spots capable of producing self-propagating chemical reaction. For secondary explosives, one expects $d_{cr} \gg a_1$, but this may not be true for primary explosives, eg $d_{cr} \approx 10^{-2}$ mm for Lead Azide; in which case

$$D_m = a_1 \quad (6a)$$

The above considerations were for *thick* samples, and are inapplicable to the usual conditions of an impact test, except for impacts on a single crystal of a primary explosive. For most secondary explosives the condition of Eq

3 does not agree with experiment, ie for these explosives the observed $P_{cr} > (3-4.8)\sigma_u$. Thus another model must be developed which takes into account the appreciable increase in σ_u that is possible in thin samples

We quote A & B:

"Suppose a rigid flat surface supports an explosive layer, which is subject to impact by a rigid cylindrical body (of diameter D) with flat base. Fig 6a illustrates impact on a layer of high density, and Fig 6b impact on a layer of low density, for example bulk density. In the latter case, the explosive should be strongly compacted in the impact zone before a significant pressure rise begins.* The deformation

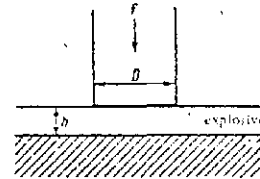

Fig 6a. Layer density close to maximum

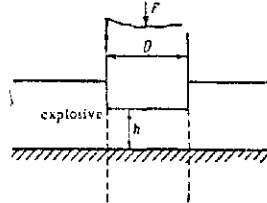

Fig 6b. Layer of low density (pressing of the material takes place at the beginning of the impact)

*Note: Typically crystal density/bulk density ~ 2 and a typical striker velocity, u_0 is ~ 5 m/sec. The minimum time for a loosely packed explosive to be compressed on impact to near crystal density is then $\sim h/2u_0$. For $h=h_{cr}=0.2$ mm this amounts to 2×10^{-5} sec or considerably longer than the initiation time of less than the 10^{-5} sec claimed by A & B for compacted explosives. A & B do not comment on this. If, as A & B suggest, no appreciable heating occurs until the sample is compressed to near crystal density, the "long" compression time should not affect their subsequent conclusions, but in practice one should observe longer times from impact to ignition for loosely packed explosives than for densely packed explosives

conditions in the impact zone are similar to the conditions in instrument No 2 (the lateral pressure of the explosive mass surrounding the striker can be disregarded, since the explosive ultimate strength even in the cast state is very low). When the critical explosion initiation conditions are satisfied, ignition takes place in the impact zone. Spreading out from the ignition spot, the explosive transformation should become detonative in order to advance beyond the compression zone. It is known that detonation can only propagate through a charge of diameter not less than d_{cr} , the critical detonation diameter (for a charge of cylindrical form). In our case the charge through which detonation should pass is a layer of thickness h ; detonation is only possible when the thickness h is not less than some critical value l_{cr} , where l_{cr} is expected to be proportional to d_{cr} , ie for detonation to propagate beyond the impact zone it is necessary that $h \geq l_{cr} = k d_{cr}$ (k being a proportionality factor, apparently close to 1/2). We draw attention to the fact that l_{cr} in the compression zone (a two-sided shell) is smaller than in the noncompressed layer. Thus, the propagation of detonation is limited by the noncompressed explosive, in the first place by the emergence from the compression zone into the noncompressed explosive"

Now from Eq 2, $\bar{P}_u \geq \bar{P}_{cr}$ & $h \geq l_{cr}$ we obtain for *thin* explosive layers

$$F_m = \pi/4 D_m^2 \bar{P}_{cr} \quad (6)$$

and

$$D_m = 3\sqrt{3} l_{cr} (P_{cr} - \sigma_u) / \sigma_u \quad (7)$$

If the diameter D of the striker is less than D_m or the force is less than F_m then detonation of the whole charge is impossible (provided, of course, that the velocity of the striker is much less than the velocity of sound) and explosion may occur only in the impact zone. Consider the variations which may be encountered in the case of impact on a thin layer:

1) When $h < l_{cr}$, detonation of the whole layer is impossible; explosion in the impact zone is possible if

$$F > \frac{\pi}{4} D^2 \bar{P}_{cr}$$

2) When $h \geq l_{cr}$, then for $D < D_m$ detonation of the whole layer is impossible; explosion may occur only in the impact zone after one or several attempts if $F \geq \frac{\pi}{4} D^2 \bar{P}_{cr}$ (after each fail-

ure the layer thickness under the striker becomes less than l_{cr} ; with each failure material is ejected from the compression zone and some of the explosive surrounding the striker is scattered); for $D \geq D_m$, detonation of the whole explosive layer may be initiated if

$$F > \frac{\pi}{4} D^2 \bar{P}_{cr} \geq F_m$$

Thus, for impact on a thin layer detonation can be initiated over some range of the impact parameters F and D , respectively equal to or greater than F_{min} and D_{min} , if the layer thickness h is equal to or greater than l_{cr}

Analogous to the requirement of $d_{cr} \geq a_l$ for thick samples, we now have $d_{cr} \geq h_l$. For $h_l > d_{cr}/2$ (encountered only for primary explosives, if at all) l_{cr} in Eq 7 should be replaced by h_l . Also, to a good approximation, for $d_{cr}/2 > h_l$ (the usual case for secondary explosives) we replace l_{cr} by $d_{cr}/2$ in Eq 7, which then becomes

$$D_m = 2.6 \{ \bar{P}_{cr} - \sigma_u(T_o) \} d_{cr}(T_o, \mu, \rho_o) / \sigma_u(T_o) \quad (8)$$

where the terms in () indicate functional dependence, eg d_{cr} is a function of initial temperature, explosive particle size, and initial density of the explosive sample etc

Let us now examine how these initial conditions affect D_m and consequently the force required for initiation, remembering that F_m increases as the square of D_m ; thus a fairly small increase in D_m can lead to a substantial increase in F_m and consequently a *decrease* in *impact sensitivity*

For pure primary & secondary explosives (except for border-line HE such as Ammonium Nitrate or Ammonium Perchlorate) d_{cr} decreases as ρ_o increases until ρ_o approaches very close single crystal density when d_{cr} may increase drastically. Thus if we limit ourselves to $\rho_o \leq 0.9 \rho_{cryst}$, increases in ρ_o (according to Eq 8) should result in a *greater sensitivity to impact*. This is quite the opposite of what is found for shock initiation and will be examined more closely later on. At a fixed density, d_{cr} increases as μ increases (see A & B, p 90). This increase is fairly pronounced at small μ (<0.2 mm) but levels off & becomes almost asymptotic at large μ (>0.4mm, except for cast TNT or TNT with 1% paraffin oil). Thus an increase in μ , as expected, leads to a *decrease*

in impact sensitivity. The effect of T_0 is more complicated. As expected, d_{CR} decreases as T_0 increases, but so does σ_u . Since d_{CR} & σ_u occur in the numerator and denominator of Eq 8, and also as a negative term in the numerator, it is not possible to determine the effect of T_0 without specific information on the values of d_{CR} & σ_u at a particular T_0 for a particular explosive. Furthermore, and this is not considered by A & B, a T_0 appreciably above room temperature means that less energy needs to be expended for hot spots to reach T_{CR} than for the same system initially at room temperature

Because of all these compensating factors, the effect of T_0 on impact sensitivity is expected to be fairly small, but there may be regions of T_0 where the effect could be appreciable

The chemical reactivity of the impacted explosive is manifested primarily thru P_{CR} which controls T_{CR} (see Eq 1): the more "reactive" the explosive the lower the T_{CR} . Of course d_{CR} also depends to some degree on chemical "reactivity." Increased reactivity affects P_{CR} & d_{CR} in the same direction, ie towards increasing the impact sensitivity

8) All the above considerations were primarily for well-compacted solid explosive wafers impacted in a laterally unconfined state (Kholevo No 2 machine). How do these considerations change if impacts are made in a Kholevo No 1 machine which provides some lateral confinement of the explosive sample? The degree of lateral confinement depends on g the thickness of the air gap between striker/anvil and the surrounding sleeve. Obviously if g is large Kholevo No 1 impact results should be indistinguishable from Kholevo No 2 results. According to A & B, it is very difficult to initiate explosives in the Kholevo No 3 machine in which $g \rightarrow 0$. The expression, analogous to Eq 2, proposed by A & B for Kholevo No 1 impacts is

$$\bar{P}_u = \sigma_u(1 + h/g2\sqrt{3} + D/h3\sqrt{3}) \quad (9)$$

According to A & B, the critical stresses for the No 1 & No 2 machines are essentially equivalent, therefore, comparing Eqs 2a & 9 (where the h 's are replaced by h_{CR} 's) the critical sample thickness is greater in Kholevo No 1 than the critical thickness in Kholevo No 2.

The Kholevo No 1 machine (with small g) has the advantage that any localized ignition (because of confinement) spontaneously leads to explosion. Thus characterizing the impact sensitivity of a laterally-confined explosive requires only the determination of conditions necessary for initiation. But this determination depends on both the properties of the explosive and the conditions of deformation (magnitude of g). Thus *no specific explosive sensitivity can be defined for laterally (more or less) confined impacts*. By way of contrast, in unconfined impacts (Kholevo No 2) the concept of explosive sensitivity has meaning, but now must determine now only the conditions for initiation but also those for propagation

9) The wide scatter and probabilistic nature of impact measurements are attributed by A & B not to any statistically controlled initiation or propagation processes but primarily to fluctuations in σ_u for the explosive samples

10) We have attempted to present A & B's views on impact initiation of solid explosives. In spite of the concerted effort of these authors to develop a quantitative or at least semi-quantitative picture for impact sensitivity, A & B realize that they have not achieved that goal. We quote:

"Consider briefly the relative character of sensitivity evaluation, namely, that it is possible only to speak of a higher or lower sensitivity of one explosive as compared with another. *It would be meaningless, for example, to say that the sensitivity of some explosive is so many times higher than that of another explosive.* No single sensitivity has this property: in this sense it is analogous with such a property of explosives as, for example, detonation capacity. It is most convenient to compare explosives with respect to sensitivity, against those explosives about whose sensitivity fairly firm empirical ideas exist, eg the explosives of a reference series"

This writer heartily subscribes to these conclusions

Experimental Evidence: We will now discuss the evidence presented by A & B in support of their views of impact initiation described above. After a brief description of their main experimental techniques we will attempt to present experimental data that support each

of the *ten* topics of the previous section. Since these overlap to some extent the experimental data will also overlap occasionally

The best evidence in support of A & B's views comes from experiments performed in the apparatus shown in Fig 7. This apparatus

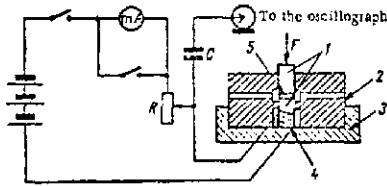

Fig 7. Design of apparatus and connection of the pickup to the oscillograph
1-rollers; 2-sleeve; 3-bedplate; 4-transducer; 5-charge

yields stress-time records which are analyzed to give the average stress-time, \bar{P} vs t , striker velocity-time, u vs t , sample displacement time, Δh vs t , and displacement vs average stress curves, Δh vs \bar{P} , shown in Fig 8. The

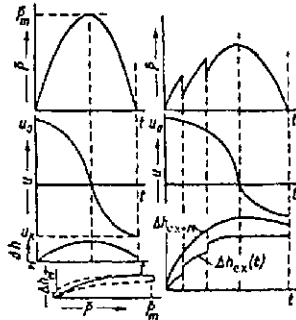

Fig 8. Interpretation of oscilloscope traces of pressure pulses

curves on the left are for a Kholevo No 2 apparatus without an explosive sample, and the ones on the right are with an explosive sample. Time resolution is 5 to 10 μsec & the uncertainty in stress is about 10%. These curves show that \bar{P} (without explosive sample) is independent of hammer weight or drop weight and is determined solely by the kinetic energy of the hammer. The Δh vs \bar{P} curve uniquely determines the loading conditions of the particular instrument for which it was obtained. The sharp drop-offs of both the \bar{P} - t and Δh_{ex} - t records, for impacts with an explosive sample, correspond to fracture of the sample and ejection of some of the fractured

material from the compression zone. Explosions are also characterized by sharp pressure drops. For primary explosives A & B present convincing evidence that explosion occurs before fracture and in times of the order of 10 μsec . For secondary explosives the evidence is not as clear-cut. Incidentally, because of the "slow" (relative to sound velocity) rate of loading the impact process is essentially a static process, i.e. stresses in the striker & sample are equalized and there is no effect of impedance mismatch found in shock loading

1) No new evidence is presented in support of the thermal nature of impact initiation. However A & B give a detailed analysis, based on results obtained with the apparatus just described, of the energy distribution in the Kholevo No 2 machine. Thus,

$$W_o = W_m^{\text{Pl}} + W_m^{\text{el}} + W_s + W_{\text{ex}}$$

where W_o is the kinetic energy of impact, W_m^{Pl} & W_m^{el} are the work of plastic & elastic deformation of the striker & anvil, W_s are the irreversible seismic energy losses, & W_{ex} is the elastic and plastic work in deforming the explosive charge. In a typical case (for which explosion is observed) if all of W_{ex} goes into uniform heating of the explosive the temperature rise in the explosive will amount to only 30°

2) There is no direct experimental justification for the assumption that the initiation process is separable into a heating stage (to T_{CR}) & a self-ignition stage (at T_{CR}). Justification comes from the self-consistency of the over-all picture of impact sensitivity developed by A & B

3) & 4) Here again evidence is circumstantial. The existence of \bar{P}_{CR} (ideally no explosions below \bar{P}_{CR} & no failures above \bar{P}_{CR}) is required by the model which is summarized by Eqs 1 & 1a. Experimental verification of the existence of \bar{P}_{CR} will be presented below. It must be emphasized, however, that the model of Eqs 1 & 1a is not the only one capable of explaining the existence of \bar{P}_{CR}

5) We will now present data in support of the existence of \bar{P}_{CR} and Eq 2. Since most of these data are shown as functions of h , the original thickness of the explosive samples, we must first examine the validity of using h rather than the thickness of an impacted sample

Pre-pressed explosive wafers (at around 90%

of crystal density) are shown to behave almost elastically for deformations of less than 10% and then fracture. If one assumes that explosion occurs before this first fracture (at least for $h_{cr} \geq h$; see below & item 7 of this section) then thickness of the impacted sample just before explosion, is very close to that of the original sample

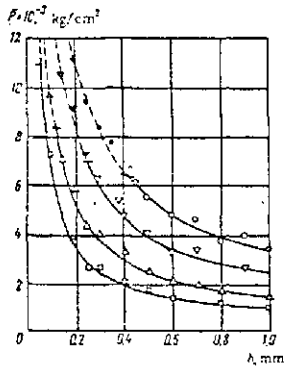

Fig 9. Average pressures upon fracture (P_{ult} —solid curves) and upon explosion (P_{ex} —dashed curves) vs charge thickness of HMX (○), RDX (▽), Tetryl (△) and TNT (□)

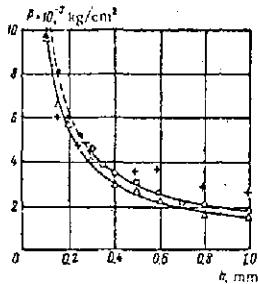

Fig 10. Average pressures P_{ult} and P_{ex} vs charge thickness for PETN (○) and Trinitrophenol (△) Points marked + refer to Dina

Figures 9 & 10 show A & B's results in the form of \bar{P} vs h plots for a number of different explosives at around 90% crystal density. They claim that for PETN, RDX & HMX, \bar{P} is unaffected (within a 10% experimental uncertainty) if particle size distribution is varied from 1-10 μ in one series of experiments to 315-400 μ in a second series. They also claim that \bar{P} is the same (within experimental error) for pressed wafers

& for single crystals. Particle size affects the spread in \bar{P} (but not the average) in the sense that spread is decreased as particle size decreases. Furthermore, A & B state that pre-pressing the explosives at 200atm or 20,000atm has no effect on \bar{P} . The writer estimates that PETN & RDX at 200atm have a bulk density, ρ_o , of about 80% of crystal density. Thus, according to A & B, \bar{P} does not depend on ρ_o in the range $80\% \leq \rho_o \leq 100\%$ of crystal density

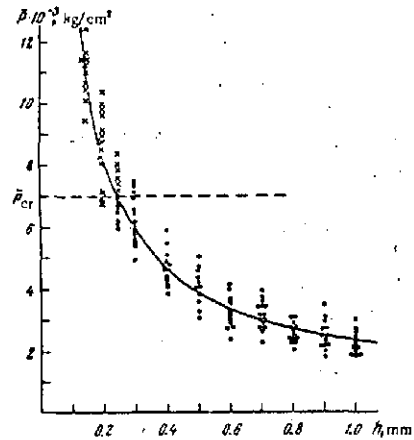

Fig 11. Spread of the measured pressures upon fracture (P_{ult} —circles) and upon explosion (P_{ex} —crosses) for RDX

Figure 11 shows the typical variation in experimental data and indicates the accuracy with which \bar{P}_{cr} can be determined. Incidentally Eq 2 fits the data of Figs 9, 10 & 11 to within experimental error

Two other observations are of interest: \bar{P} does not depend on hammer drop height (or drop velocity)

The empirical relation,

$$\sigma_U = 4.2 T_M (\sigma_U \text{ in kg/cm}^2 \text{ \& } T_M \text{ in } ^\circ\text{C}) \quad (10)$$

appears to be well-obeyed by explosives for which data are available

The critical stresses and critical thickness, obtained from Figs 9, 10 & 11 are summarized in Table 5

TABLE 5: Critical Stresses & Thicknesses
in Instrument No 2 for Various Explosives

Explosive	$P_{cr} 10^{-3} \text{ kg/cm}^2$	$h_{cr} \text{ mm}$
TNT	~11	~0.08
Trinitrophenol	~9.5	~0.11
Tetryl	~8.4	~0.12
RDX	7.0	0.25
HMX	6.4	0.43
PETN	4.8	0.27

6) To show that shear, due to a discontinuous rate of straining, is at a maximum at the upper and lower (contact) planes of an explosive sample, impacted in Kholevo No 2, and zero at its mid-plane, A & B performed the following experiment. Two sets of 1mm thick HMX samples were prepared: set 1 contained a thin layer of Lead Azide at its mid-plane, set 2 had a thin layer of Lead Azide on the upper, lower or both sample surfaces. Set 1 samples behaved just like pure HMX in that only fractures and no explosions were observed ($h > h_{cr}$, see Fig 13). All set 2 samples exploded

They also used set 2-type PETN, RDX, Tetryl & TNT to show that \bar{P}_{cr} for Lead Azide is 2.6 ± 0.2 kbar and that \bar{P}_{cr} (at least for Lead Azide) is independent of h or h/D

7) The experimental results discussed below deal with certain aspects of initiation and propagation of impact explosions but some of discussion overlaps topics 5 & 6

The usual charge thickness ("standard" charge) for HE in Kholevo No 2 is ~0.4mm (~50mg of HE). At this charge thickness anomalous behavior is encountered with some of the "less sensitive" explosives. Figure 12 shows explosion frequency as a function of impact energy for three explosives (HMX, RDX & Tetryl) all at "standard" (or nearly standard) charge thickness. Note that HMX at $h \sim h_{cr}$ gives the expected "S" shaped frequency curve. For RDX $h > h_{cr}$ and the frequency curve is flattened for $f > 1$. For Tetryl $h \gg h_{cr}$, results are erratic, and f is almost independent of impact energy. Explosion frequency, f , never exceeds ~0.2 for an almost 4-fold increase in impact energy

On the basis of experimental evidence and theoretical considerations, A & B conclude that the frequency curve (f vs impact energy) should be narrowest for $h = h_{cr}$ and still be narrow

for $h \leq h_{cr}$. For $h > h_{cr}$, the condition $\bar{P} \geq P_{cr}$ is not satisfied and at first glance explosion should not occur. That explosions do occur for $h > h_{cr}$ is shown in Fig 12. The explanation

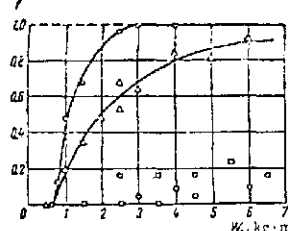

Fig 12. Explosion frequency vs impact energy for Tetryl (\square) and RDX (\triangle) for charges 0.4mm thick and for HMX (\circ) charges 0.5mm thick

offered for this contradiction is that fracture of the sample occurs before explosion for $h > h_{cr}$. If the impact energy is sufficiently high sequential fractures (see Fig 8) can produce a "new" sample thickness h_n such that $h_n \leq h_{cr}$. Now if $P_n \geq P_{cr}$ explosion can occur. This sequential process tends to increase the variability of the dependence of fractures on P and consequently on impact energy. Thus f vs impact energy curves should show more spread than those for $h \leq h_{cr}$. Presumably at $f \rightarrow 1$, ie large values of impact energy (and consequently \bar{P}) there are more fractures and the frequency curve gets more spread out (flattened) than in the lower range of frequencies. The non-dependence of f on impact energy, observed for Tetryl & TNT, is explained by A & B as follows: "Suppose h_1 is not much smaller than h_{cr} (h_1 it will be recalled is the limiting sample thickness for which hot-spots can lead to self-ignition), then the charge thickness, decreasing during fractures & ejections, may turn out to be below h_1 in which case no explosion should occur. However large the impact energy, the explosion frequency no longer depends on impact energy but is determined by the frequency with which the charge thickness, decreasing in jumps, enters the interval h_{cr} to h_1 "

An interesting consequence of the above considerations is the prediction that f -impact energy curves should be greatly "flattened" in impact machines having small diameter strikers. This prediction is based on the expectation that \bar{P}_{cr} does not depend on h or

h/D . Thus the curves of Figs 9, 10 & 11 could just as well have h/D instead of h for the abscissa. Consequently one can just as easily speak of $(h/D)_{CR}$ as h_{CR} . Now if D is reduced h_{CR} must also decrease to keep $(h/D)_{CR}$ constant. With a reduced h_{CR} and "standard" thickness samples the anomalous frequency effect, and indeed failures at all impact energies, should be observed more frequently than at larger D (ie larger h_{CR}). This expectation is in accord with experience. All the anomalous effects are more pronounced in the so-called Weller impact machine ($D = 1.5\text{mm}$) than in Kholevo No 2 ($D = 10\text{mm}$). It should be noted, however, that primary explosives, for which h_{CR} is large, are initiated at rather low impact energies in the Weller machine. This is so because h_{CR} is still quite large, in the Weller machine, and its small D makes it possible to attain \bar{P}_{CR} at low impact energies ($P = 4F/\pi D^2$)

Useful information is also obtained by plotting f vs h at different impact energies—Fig 13.

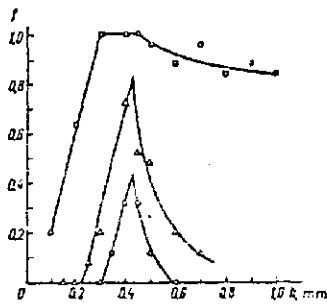

□—2.5 kg/m; △—1.0 kg/m; ○—0.8 kg/m

Fig 13. Explosion frequency vs charge thickness in the case of HMX for various impact energies

From these plots, one can obtain h_{CR} . Table 6 shows that h_{CR} based on \bar{P} measurement are in excellent agreement with those based on frequency measurements

TABLE 6. Charge Thickness h_{CR} (mm) for Transition from Fracture to Explosion (in Instrument No 2)

Explosive	From pressure measurements	From the frequency peak
HMX	0.43	0.42–0.43
RDX	0.25	0.25
Tetryl	~0.12	~0.10–0.13
PETN	0.27	0.27
TNT	~0.08	~0.10

Andreev and Terebelina (Ref 7) performed a large number of impact experiments, in Kholevo No 2 type machine, in which they varied sample weight and sample location, and observed the explosion frequency at a fixed impact energy. Sample location, for a fixed sample weight, was either in the central region between striker and anvil ($D=5$ mm) or spread uniformly between anvil and striker ($D=19$ mm). Obviously the centrally located samples were thicker than the uniformly-spread samples. For "sensitive" explosives, primaries, PETN, RDX, HMX, etc they found high explosion frequencies for centrally-located samples and almost no explosion for spread samples (except Mercury Fulminate or Lead Picrate for which sample location had no real effect). A & B's interpretation of these results is that for the "sensitive" explosives $h/D \approx (h/D)_{CR}$ for the central charges and $(h/D) \ll (h/D)_{CR}$ for the spread charges. In the latter case either the impact energy is too low so that explosion frequency drops to zero at small h (see Fig 13), or else $h < h_1$ in which case there would be no explosion at any impact energy. Conversely for "insensitive" explosives $(h/D) \gg (h/D)_{CR}$ for central charges and $(h/D) \approx (h/D)_{CR}$ for spread charges. The effect of variation in sample weight can be interpreted similarly.

A & B give no quantitative comparison between Andreev & Terebelina's data and $(h/D)_{CR}$ obtained by A & B. We have done this under the assumption that all of the Andreev & Terebelina's charges are at a density of 1 g/cc.

Qualitatively the expected trends do show up but quantitative agreement is frequently poor

According to Eq 8 and the subsequent discussion (in topic 7 of the previous section) impact sensitivity should: a) increase with increasing sample density, b) increase with de-

creasing sample size, c) probably be independent of initial temperature. The experimental findings of A & B (see topic 5 of this section) are not in accord with suppositions a) & b) since impact sensitivity was found to be essentially independent of sample density & particle size. No direct evidence of the effect of initial temperature is presented. However, according to Eqs 2a & 9, h_{cr} should decrease as T_0 increases (because σ_U decreases as T_0 increases). A & B's data for HMX confirm this expectation

We return briefly to an important consideration touched on at the beginning of this section and in topic 4 of the previous section, namely the time delay between impact and explosion. The idealized diagram (Fig 19 of A & B) shown below will be helpful in the following analysis

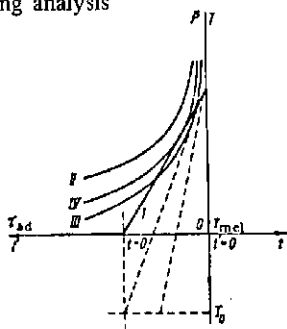

In this diagram time coordinates have been changed by the transformation $t' = \tau_d - t$ where t is real time and $t' = \tau_d$ or $t = 0$ is the time at the beginning of impact. Thus impact occurs at $t = 0$ and with the above transformation explosion occurs at $t' = 0$; also at $t' = 0$, $\bar{P} = \bar{P}_{ex}$. If, for simplicity, we assume that the impacted sample is at T_m at $t = 0$, then (in accordance with Eq 1a) its $T-t$ history will be given by curve I in the diagram. For each T there is a corresponding adiabatic explosion time τ_{ad} . Three typical $T-\tau_{ad}$ plots (curves II, III & IV) are shown in the diagram. Curve II does not intersect curve I, therefore there can be no explosion at $t' = 0$. Curve III intersects curve I twice, therefore explosion should have occurred before it actually did, which is contrary to the assumption of explosion at $t' = 0$. Curve IV, which has a point of tangency with curve I, is thus the only possible curve that satisfies the requirements of the problem under consideration. This condition of tan-

gency is obtained as follows:

From thermal explosion theory (eg see article on *Hot Spots* in this Vol)

$$\tau_{ad} = \frac{cRT^2}{QZE} e^{E/RT} \quad (11)$$

and from curve I of the diagram

$$\tau_{ad} = -(\bar{P}_{ex} - \bar{P}) dt'/d\bar{P} \quad (12)$$

From Eqs (1a) & (12) the tangency condition becomes,

$$\frac{\alpha d\tau_{ad}}{dT} = \frac{dt'}{d\bar{P}}$$

and via Eqs (11) & (12) leads to

$$(\bar{P}_{ex} - \bar{P})/\bar{P} = RT^2/E(T - T_m) \quad (13)$$

and

$$\tau_{ad} = \tau_d RT^2/E(T - T_m) \quad (14)$$

The only effect of altering initial conditions to $T = T_0$ at $t = 0$ instead of $T = T_m$ at $t = 0$ (as assumed above) is to change the equality sign in Eqs (13) & (14) to less-than-or-equal (\leq) signs; proof of this is given by A & B. Now for most secondary explosives for $400 \leq T \leq 700^\circ$ C, the expected range of T_{cr} , the term $RT^2/E(T - T_m) \leq 0.1$ and consequently

$$P_{ex} - \bar{P} < 0.1 \bar{P}_{ex}$$

and $\tau_{ad} < 0.1 \tau_d$

Typically $\tau_d \approx 10^{-4}$ sec and consequently the time delay between impact and explosion (τ_{ad}) is $\approx 10^{-5}$ sec or less

8) We have already alluded to the applicability of A & B's impact model to the Weller impact machine. Below we examine the applicability of their ideas to other impact machines that also create rapid shear in the explosive samples. Let us consider the following tabulation (Table 11 of A & B) where all the P's refer to compression stresses in the explosive

Here \bar{P}_{cr} is the same as that of Table 1; \bar{P}_{fric} is from the data of Kozlov & Mamaev for experiments carried out under rapid shear; \bar{P}_{fricM} (data of Muratov) was obtained under conditions similar to \bar{P}_{fric} experiments except that the explosive was confined by a tin ring; \bar{P}_{I-p} are results of experiments with Kholevo No 1 in which the striker was rotated 10° to produce

TABLE 11. Critical stresses (in thousands of kg/cm²) obtained in different instruments

Explosive	\bar{P}_{cr}	\bar{P}_{fric} (50%)	\bar{P}_{II-p} (50%)	\bar{P}_{fric} (100%)	\bar{P}_{II-p} (100%)	$\bar{P}_{fric M}$ (100%)	\bar{P}_{I-p} (30%)	\bar{P}_{I-p} (100%)
TNT	~11	7.2	6.8	11	9.6	10.8	9.6	—
Trinitrophenol	~ 9.5	5.7	—	7.4	—	—	—	—
Tetryl	~ 8.4	4.7	—	6.1	—	6.8	—	—
RDX	7.0	4.2	5.2	5.7	7.2	6.8	6.5	9.6
PETN	4.8	3.1	2.8	5.4	4.8	5.3	5.3	8.7
Lead Azide	2.6	1.6	—	3.1	—	1.8	—	—

“shear” (data of Bochkov & Kupriyanov); \bar{P}_{II-p} is the same as \bar{P}_{I-p} but with Kholevo No 2; bracketed numbers are explosion frequencies

The trends of the various \bar{P} values obtained with six different impact systems are in obvious qualitative accord. Closer examination of the data reveals that \bar{P}_{fric} & \bar{P}_{II-p} for $f = 50\%$ are always lower than \bar{P}_{cr} . This is to be expected since \bar{P}_{cr} is essentially for $f = 100\%$ (see Fig 11). Consequently it is not surprising that \bar{P}_{cr} agrees well with \bar{P}_{fric} , $\bar{P}_{fric M}$ & \bar{P}_{II-p} for $f = 100\%$. According to A & B, Mamaev ($\bar{P}_{fric M}$) showed that the lowest compression pressure (for PETN) was obtained when the sample was placed near the center (not the periphery) of his apparatus. This is in accord with A & B's argument (derived from the study of plastic metals) that peak stress P occurs at center of a sample and considerably exceeds the average stress \bar{P} (see topic 4 of the preceding section). For “confined system” of \bar{P}_{I-p} , the stress is uniform and has the value of P rather than \bar{P} . It should be noted that \bar{P}_{I-p} , which is a peak stress, is roughly twice \bar{P}_{cr} which is an average stress. This is in accord with Eq 4

The expectation that h_{cr} in Kholevo No 1

is greater than h_{cr} in Kholevo No 2 (see Eq 8) is fully confirmed by experiment according to A & B

9) No experimental evidence is given by A & B in support of their contention that σ_u varies appreciably for supposedly equivalent samples. However, this contention seems logical for the highly non-isotropic nature of an explosive sample consisting, as it does, of a variety of different sizes and shapes of explosive grains.

10) In topic 7 of the preceding section we summarized A & B's development of the concepts of *minimum impact force* and *minimum impact diameter* (Eqs 6, 7 & 8), and in topic 10 we indicated that quantitative agreement between theory and available experimental data is poor. Now we present this comparison. For some strange reason, probably due to the unavailability of the appropriate data, A & B choose to compute D_m & F_m from data for d_{cr} for $\rho_o \sim 1$ g/cc charges of roughly 0.1mm particle size, whereas their best measurements in Kholevo No 2 are for $\rho_o \sim 1.5$ g/cc samples. Table 6 presents their computations and also summarizes their measurements with the Kholevo No 2 machine with a sample diameter $D \leq 10$ mm

TABLE 7. Impact Characteristics of Some Common Explosives

Explosive	$\sigma_{ult} \frac{kg}{cm^2}$	$\bar{P}_{cr} 10^{-3} kg/cm^2$	$(h/D)_{cr} 10^{-2}$	$d_{cr} mm$	$D_{min} cm$	$F_{min} kg$
TNT	340	~11	~0.8	12	~75	~5.3·10 ⁷
Trinitrophenol	520	9.5	~1.1	7	~32	8.9·10 ⁴
Tetryl	520	~8.4	~1.2	5	19	~2.4·10 ⁵
RDX	820	7.0	2.5	2.5	5.0	1.3·10 ⁵
HMX	1250	6.4	4.3	4	4.6	1.1·10 ⁶
PETN	600	4.8	2.7	2	3.7	4.8·10 ⁴
Lead Azide	1550	2.6	28	—	—	—

It is obvious that $D_m \gg D$ where $D \leq 10\text{mm}$ is the diameter at which explosions were observed for all the explosives shown in the Table. Now for TNT, at just below crystal density, A & B quote an experimentally found $d_{cr} \sim 2\text{mm}$. Using $d_{cr} \sim 2\text{mm}$ will reduce D_m six-fold and F_m 36-fold over those shown in the tabulation, but even this reduced D_m is still much larger than D . If this 6-fold reduction of d_{cr} as ρ_c increases is also applicable to the "sensitive" explosives (RDX, HMX, PETN etc) then $D_m \leq D$ for these explosives and, as required by A & B's theory, explosion is possible outside the impact zone (which is of dimension D). For the "insensitive explosives (TNT, etc) in Table 6, $D_m > D$ and (according to A & B) explosion can occur only within the impact zone. Since the impact zone is a property of the impact machine, ie the impact zone varies with striker diameter, we have a contradiction to A & B's assertion that "impact sensitivity," determined with Kholevo No 2, is solely the property of the explosive & not a combined property of the explosive and conditions of impact. A & B make no attempt to resolve this contradiction. What they suggest, as already discussed, is that little quantitative significance be ascribed to D_m and/or F_m , but that these quantities be used to develop qualitative series of impact sensitivities, eg Lead Azide is more sensitive than PETN which is more sensitive than RDX etc

A very important facet of the general subject of impact sensitivity is the artificial lowering-desensitization-of the impact sensitivity of certain explosives. If we accept Eq 8 as being at least qualitatively correct & take D_m as a measure of impact sensitivity, then from Eqs (1), (8) & (10) and the usual situation of $\bar{P}_{cr} \gg \sigma_u$,

$$D_m \sim K(T_{cr} - T_m)d_{cr}/T_m \quad (15)$$

where K is a constant. To "desensitize" an explosive, ie increase D_m , one can increase T_{cr} & d_{cr} (ie decrease its reactivity and capacity to detonate) or decrease T_m . For a given explosive little can be done about increasing T_{cr} . Increase in particle size should increase d_{cr} and should result in decreased impact sensitivity (however see previous discussion in topic 7 about the observed lack of a particle size effect for PETN, RDX & HMX at high compaction). De-

creases in T_m can be achieved by forming eutectic mixtures of two or more explosive components. This is done in practice, eg in cyclotols, octols, tetratols etc. From Eq (8), it follows that a reduction in σ_u (which we eliminated in favor of T_m for the purpose of the above discussion) will result in a decreased impact sensitivity—at least an increase in D_m . A reduction in σ_u can be achieved by using appropriate additives such as surface-active agents, low viscosity materials etc. It seems that more development effort should be directed towards this than has been expended heretofore.

Written by J. ROTH

Refs: 1) W. J. Dixon & J. Mood, JAmStat Assn 43, 109 (1948) 2) F.P. Bowden & A.D. Yoffe "Initiation and Growth of Explosion in Liquids and Solids" Cambridge Press (1952) 3) F.P. Bowden & A.D. Yoffe "Fast Reactions in Solids" Acad Press, NY (1958) 4) F.P. Bowden, ProcRoySoc 246, 147 (1958) 4a) V.K. Bobolev & L.G. Bolkhovitinov, IzvAkad Nauk, SSSR No 4, 754 (1960) 5) M.G. Natrella "Experimental Statistics," NBS Handbk 91, (1963), pp 10-22 to 10-24 6) Andreev & Belyaev, article by N.A. Kholevo, (1963), pp 5-26 7) Ibid, pp 47-151 8) Proc Internat Conf on Sensitivity & Hazards of Explosives (London) (1963), Session 6 Note: These proceedings have no page numbers, only Session numbers 9) J.E. Ablard, Ibid, Discussion of Session 6, p 1 10) E. James, Ibid, Discussion of Session 5, p 11 11) A. Popolato, Ibid, Session 6 12) J. Wilby & H.N. Mortlock, Ibid, Session 5 13) G. Hornby & W. Merrick, Ibid, Session 5 14) D.C. Hornig, Ibid, Opening remarks 15) F.P. Bowden, 9th SympCombstn (1963), pp 499-515 16) PATR 3278 (1970), pp 2-4 17) G.T. Afanasev & V.K. Bobolev "Initiation of Solid Explosives by Impact," translated by I. Shechtman (1971), TT 70-5074, NASA TTF-623 18) B.M. Dobratz (edit) "Properties of Chemical Explosives & Explosive Simulants," LLL, UCRL 51319 (1972), p. 9-2 19) This Vol, article on "Hot Spots"

Impact Velocity. The *actual* velocity attained by a bomb or other projectile on reaching the target. This must not be confused with the so-called *terminal velocity*, which is the *theoretical*

velocity on impact for a given size and shape of projectile. This theoretical velocity cannot be attained in practice because of air resistance

Impedance, Acoustic and Shock is the product of density and sound velocity, namely ρc . Analogously shock impedance is $\rho_0 U$ where U is the shock-velocity in a medium whose density (ahead of the shock) is ρ_0 . Both acoustic & shock impedances are used to estimate the interface stress, σ , and interface particle velocity, u , for planar shocks moving from one medium into another medium. A simple method of doing this, based on the so-called *acoustic approximation*, is illustrated below

From conservation of mass & momentum (See Vol 4, pp D 604-5)

$$\sigma = \rho_0 U u \tag{1}$$

Now if we assume that $U = \text{constant} = c$ (the acoustic approximation)

$$\rho_0 U \equiv \rho_0 c \tag{2}$$

and for a given medium σ is directly proportional to u . This is shown in the following diagram (for actual $\sigma-u$ curves see Fig 3, 4 & 5 of article on *Hugoniot*s in this Vol) which represents

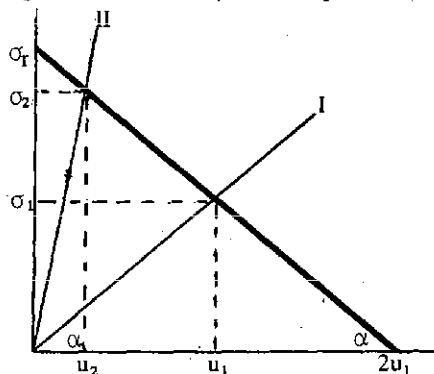

a shock in medium I entering medium II. The heavy black line is a geometric reflection of line I thru the point σ_1, u_1 . These quantities, σ_1 & u_1 , are respectively the stress & particle velocity at the interface of medium I. It is obvious from the diagram that

$$\tan \alpha = \sigma_1 / u_1 = \sigma_2 / (2u_1 - u_2) \tag{3}$$

By substituting for u_1 & from Eqs (2) & (3) and simplifying

$$\sigma_2 / \sigma_1 = 2 / (1 + \rho_1 c_1 / \rho_2 c_2) \tag{4}$$

and analogously (by substituting for σ_1 & σ_2)

$$u_2 / u_1 = 2 / (1 + \rho_2 c_2 / \rho_1 c_1) \tag{5}$$

The diagram or Eqs (4) & (5) show that for $\rho_2 c_2 > \rho_1 c_1, u_2 < u_1$ & $\sigma_2 > \sigma_1$ and conversely. Moreover by setting $\rho_2 c_2 = 0$ (medium II is a vacuum; for air $\rho_2 c_2 \sim 0$ in comparison to $\rho_1 c_1$ for continuous condensed media) the particle velocity is $2u_1$. This is the so-called *free-surface* velocity, u_{fs} , of medium I shocked to the state σ_1, u_1 . Conversely, when $u_2 = 0$, $\sigma = \sigma_T = 2\sigma_1$ (see diagram & Eq (3)). This means that the interface stress on a *rigid wall* (consequently $u_2 = 0$), in contact with a condensed medium shocked to the state σ_1, u_1 , is $2\sigma_1$. That $u_{fs} \approx 2u_1$ is also obtained from the exact solution (analytical or graphical) of the conservation equations for shocks in condensed media (Refs 1, 2 & 3). The exact solutions, however, show that $\sigma_T > 2\sigma_1$, but usually not much greater. In fact, for a rigid wall $\sigma_T / \sigma_1 \approx 2.4$

As examples of the degree of accuracy of Eqs (3) & (4), let us compute the stress & particle velocity for detonating Comp B in contact with Mg, and Comp B in contact with steel. In each case we will replace $\rho_1 c_1$ by $\rho_0 D$ for Comp B but still use the appropriate $\rho_2 c_2$ for the metals. For Mg: acoustic approx $\sigma_2 / \sigma_1 = 2(1 + 1.71 \times 8 / 1.74 \times 4.7) = 0.75$; $u_2 / u_1 = 1.25$ "exact" σ_2 / σ_1 (Ref 2) = 0.99; $u_2 / u_1 = 1.03$

For steel: acoustic approx $\sigma_2 / \sigma_1 = 2(1 + 1.71 \times 8 / 7.8 \times 6) = 1.55$; $u_2 / u_1 = 0.45$ "exact" σ_2 / σ_1 (Ref 2) = 1.61; $u_2 / u_1 = 0.50$

Note that for the metals $U_2 \geq c_2$ and consequently $\rho_2 U_2 \geq \rho_2 c_2$, therefore the acoustic approximation calculation should usually give a lower limit value of σ_2 / σ_1 & an upper limit value for u_2 / u_1

Refs: 1) Baum et al "Physics of an Explosion," Fizmatgiz, Moscow (1959) (transl 1963) Chapt IX 2) G.E. Duval, Proc Metal Soc Conf 9, "Response of Metals to High-Velocity Deformation," Estes Park, Colorado (1960), pp 173-79 3) O.E. Jones, Proc 12th Annual Symp on Behavior & Utilization of Explosives, Albuquerque, New Mexico (1972), pp 128-137

Imperial Chemical Industries. See ICI in this Vol

Imperial Schultz Powder. It consists of Nitro-lignin 80.1, Ba nitrate 10.2, vaseline 7.9 & volatile matter 1.8%. Its props are reported as follows:

Calories per g	742
Permanent gas, cc/g	763
Water vapor, cc/g	152
Total vol of gas at STP	915
Relative temp	106

This is a shot-gun powder used at one time in England

Refs: 1) Marshall 1 (197), p 327 2) Barnett (1919), p 86 3) Thorpe 4 (1940), p 530

Imperial Explosive. It consists of NH_4NO_3 65-85% & W-Si-Al alloy 15-35%

Ref: R. Imperiali, USP 1054777 (1913) & CA 7, 1419 (1919)

Implosion. The reverse of explosion—when the walls of a confining vessel collapse inwards, instead of bursting outwards. For instance, when a thin-walled glass container is partially filled with boiling water, sealed and then cooled, the vessel may collapse with a loud noise. This is due to the fact that water vapor condenses on cooling, creating a partial vacuum inside the vessel. This causes the atmosphere, which is at a higher pressure, to push the walls of the container towards the inside until they are broken

Ordinary electric light bulbs are imploded (and not exploded) when the walls are weakened by an accidental crack or from a blow

Precisely controlled detonations are used to create an *implosion* of fissionable material to achieve *critical mass* in the explosion of an atomic bomb (See Vol 1, pp A499-504)

Impulse. The impulse I , associated with a pressure pulse of duration t and pressure P is $\int_0^t P dt$ which is the area under the $P-t$ curve of the pulse. For triangular pressure pulses of peak amplitude P_m , $I = P_m t/2$, and for an exponentially decaying pressure pulses $I = P_m/B(1 - e^{-Bt})$ where B is the decay constant. In the cgs system I has the dimensions of dyne sec/cm²

The impulse delivered to a structure determines whether the structure moves, how far

it will move, and under certain conditions what damage it sustains (see article on impulsive loading of structures in this Vol). Impulses can be generated by a detonating explosive, a burning propellant, a flying projectile or indeed anything that creates a pressure pulse

The impulse delivered by a detonating explosive at some distance (in air) from the explosive charge is briefly discussed in Vol 2, p 181-L. A more detailed discussion of explosively-generated blast pressures & impulses, both in air and under water, will be given in a future volume under "Scaling Laws for Blast." Below we will discuss explosively-generated impulses delivered to structures or media in contact with the explosive charge or separated from it by a relatively thin layer of attenuating material

Theoretical Considerations

To gain some insight into these phenomena, without getting too involved in mathematical complexities, let us first examine some limiting cases of impulse delivered to: a) a rigid wall & b) air (for HE detonations there is very little difference in the final results in the explosive impulse delivered to air or to a vacuum)

a) The rigid wall problem has been treated in detail by Baum et al (Ref 2), on the basis of a polytropic equation of state for the detonation products and a polytropic coefficient $\Gamma=3$. They find that

$$I = 8/27 c_a D \quad (1)$$

where D is the detonation velocity and c_a is the explosive weight per unit area of explosive. In a following section we shall obtain a similar result by quite a different method

b) Baum et al also consider this case but only indirectly & in a somewhat complex treatment (Ref 3). As an illustrative example, we will now present our adaption of Baum's treatment:

A semi-infinite explosive slab of thickness h , bounded on both free faces by vacuum (or air), is initiated instantaneously at one free face. We wish to compute the impulse delivered at the other free face. From the polytropic equation of state assumption it follows that:

$$c = c_j (\rho/\rho_j) \quad (2)$$

$$\text{and } P = P_j (\rho/\rho_j)^\Gamma = P_j (c/c_j)^\Gamma \quad (3)$$

where the subscripts j indicate CJ quantities, ie quantities at detonation equilibrium. If we place

the origin of our coordinate system at the plane of initiation, ie $x = 0$ at that plane & $x = h$ at the other explosive face, then the usual solutions of the Riemann invariants (Ref 1) coupled with the above assumption about the equation of state of the detonation products, give,

$$x = (u + c)t \tag{4}$$

where u & c are local particle & sound velocities at time t

From symmetry considerations $u = 0$ at $x = h/2$. Then from Eq (4),

$$c = h/2t \tag{5}$$

For polytropic detonation products with $\Gamma = 3$,

$$c_j = 3/4D \tag{6}$$

Substituting the values of c & c_j from Eqs (5) & (6) into Eq (3) we obtain,

$$P = (8/27)P_j(h/D)^3 t^{-3} \tag{7}$$

In our problem, $I = \int_t^\infty P dt$, and from Eq (7), with $t = h/D$, $P_j = \frac{\rho_o D^2}{4}$ & $c_a = \rho_o h$, we obtain,

$$I = 1/27 c_a D \tag{8}$$

or 1/8 of the impulse delivered to a rigid wall (see Eq (1)). This is also the result obtained by Baum (Ref 3)

The results of Baum et al (Ref 4) can also be interpreted to mean that if the above HE slab were initiated instantaneously at its midplane,

$$I = 2/27 c_a D \tag{9}$$

or twice the impulse of Eq (8). From symmetry, this case is equivalent to an HE slab of thickness $h/2$ (thus $c_a/2$), confined by a rigid wall at its plane of initiation

To determine how the numerical factors in Eqs (1), (8) & (9) vary with Γ (the other terms are unchanged by variation in Γ as long as the equation of state is still of the polytropic form) we have re-computed Eq (1) in its generalized form,

$$I = \rho_o D (\Gamma + 1)^{\Gamma-1} / \Gamma^{\Gamma} (\Gamma-1) \tag{9a}$$

for several Γ 's

The tabulation below

Γ	3	2.5	2	3/2	1
Factor	0.296	0.445	0.750	1.720	∞

shows that the numerical factors increase as Γ decreases

For many purposes, rather than using the total impulse I , it is more convenient to use an impulse per unit area per unit explosive weight, ie

$I_1 \equiv I/c_a$, or $I_o \equiv \rho_o I/c_a = \rho_o I_1$ (where ρ_o is the density of the unexploded HE) which we shall call the impulse constant. The term I_1 has the dimensions of velocity and is closely related to specific impulse which is commonly used as a measure of effectiveness of propellant systems. I_o has the dimensions of dyne sec/cm³ in the cgs system. Thus I_1 & I_o are readily obtained from Eqs (1), (8) & (9) by dividing by c_a to get I_1 and then multiplying I_1 by ρ_o to get I_o .

So far we have only considered limiting cases and "head-on" detonations. How is the impulse generated by a given explosive system modified if the detonation is tangential ("running" detonation) rather than head-on to the medium in contact with the explosive? Also what changes are to be expected if the medium is neither a rigid wall nor a vacuum? A qualitative answer to the second question is obvious from the foregoing discussion; for a "non-rigid" wall the impulse delivered will lie somewhere between that delivered to a rigid wall and to a vacuum. However a generally-applicable quantitative answer to this question is not available. As will be shown later, theoretical calculations can be made for specific HE/medium systems but these cannot be generalized to all HE/medium systems

An alternate method of computing I , or better I_o , is based on the Gurney formula (See Vol 6, p G195-L)

For a running detonation, ie detonation initiated at one end of a HE slab, the velocity v it imparts to a plate of mass m , where the other face of the explosive slab is bounded by another plate of mass m' , is given by:

$$v = \sqrt{2E'} \left[\frac{3}{1+3m/c - \frac{1+2m/c}{1+2m'/c} + (1+3m'/c) \left(\frac{1+2m/c}{1+2m'/c} \right)^2} \right]^{1/2} \tag{10}$$

where $\sqrt{2E'}$ is the Gurney constant for a running detonation of the particular explosive used (Ref 5). Now the momentum imparted to plate m , whose area is A , is mv , and $mv/A = I$ or $\rho_m h_m v = I$ where ρ_m & h_m are plate density & thickness. Since $I_o = \rho_o I/c$, Eq (10) can be modified to give,

$$I_o = \rho_o \sqrt{2E'} m/c \left[\quad \right]^{1/2} \quad (11)$$

where the bracketed term is the same as in Eq (10) and both m/c and m'/c are on a per unit area basis. For the conditions $m/c \gg 1$ & $m'/c > 0$, Eq (11) becomes,

$$I_o = \rho_o \sqrt{2E'} \sqrt{\frac{3}{2} \frac{(1 + 2m'/c)}{(1 + 3m'/c)^{1/2}}} \quad (12)$$

This reduces to,

$$I_o = \rho_o \sqrt{2E'} \sqrt{\frac{3}{2}} \quad (13)$$

if $m'/c \ll 1$, eg, for a system in which one face of the HE slab is in contact with air

The writer has shown (Ref 9) that for $m/c \gg 1$ & $m'/c \ll 1$,

$$\sqrt{2E'} = \frac{0.578D}{\Gamma-1} \quad (14)$$

for a "head-on" detonation and,

$$\sqrt{2E'} \approx \frac{0.95 \times 0.578D}{\Gamma-1} \quad (15)$$

for a tangential detonation. Thus Eq (13) becomes, for $\Gamma = 3$,

$I_o = 0.250\rho_o D$ for "head-on" detonation and $I_o = 0.238\rho_o D$ for tangential detonation. These are to be compared with the numerical factor of $0.296 = 8/27$ obtained by Baum's method discussed above (Eq 1).

The ratios of numerical factors obtained by Baum's method divided by those obtained by the Gurney method are:

Γ	4	3	2.5	2	1.5
Ratio	0.98	1.20	1.29	1.50	1.72

Thus in the expected HE range of $2.5 \leq \Gamma \leq 3$, for a given ρ_o & D , the impulse constant, I_o , computed by Baum's method will be 20-30% greater than that computed by the Gurney method. As will be shown later, I_o by Gurney's method is in better accord with measurements than I_o by Baum's method

Equation (15) combined with Eqs (12) or (13) shows that the impulse delivered by a

running detonation is only slightly less than that delivered by a head-on detonation. Equation (12) also suggests why it is permissible to neglect the differences between air and vacuum. For vacuum $m'/c = 0$. Even if m'/c for air is as high as 0.1 (we certainly expect it to be less for HE in contact with air) the error is only about 5%. A more sophisticated and convincing argument leading to the same conclusion is given in Ref 10

Before comparing the above theoretical results with experiment, let us return briefly to the question of "non-rigidity" of the medium in contact with an exploding HE slab. Erkman (Ref 6) using a numerical procedure based on the method of characteristics obtained values of I_o for various media in contact with EL506D sheet explosive containing about 70% PETN & 30% binder whose $\rho_o = 1.4\text{g/cc}$ & $D = 7100\text{ m/sec}$

Erkman's results (shown in Table 1 of the next section) indicate that I_o decreases as medium density decreases. Erkman did not carry out his calculations for the rigid wall case to sufficiently large values of t (ie, his arbitrary calculation cut-off does not account for all the impulse in the "tail" of the P-t curve). Consequently, his values of $I_o = 2.8 \times 10^5$ dyne sec/cm³ for the rigid wall is expected to be somewhat low

From Eqs (13) & (15), using $\Gamma=2.6$ (appropriate for PETN), we compute $I_o = 3.0 \times 10^5$ dyne sec/cm³ for EL506. In view of the above, this is in excellent accord with Erkman's result. If we assume that the factor of 0.95 between head-on and tangential detonations (Eqs (14) & (15)) is also applicable to Baum's method of calculating I_o for a running detonation, then from Eqs (1) & (9a), with $\Gamma=2.6$, $I_o = 3.8 \times 10^5$ dyne sec/cm³ which is some 25% greater than the I_o computed by the Gurney method

Comparison of Experiment and Theory

Defourneaux & Jacques (Ref 7) present data for 65/35 Cyclotol & Octol that can be used to check the theoretical considerations of the previous section. They used flash radiography to measure deflections, φ , of a steel plate in contact with a detonating slab of HE. Their measurements correspond to what we have called tangential or running detonation. They found that $1/\varphi$ is a linear function of m/c namely, $1/\varphi =$

$A + B m/c$, where A & B are dimensionless

Plate velocity is given by $v = 2D \sin \varphi/2$, and for the small φ of their measurements $v \approx D\varphi$ so that $I_1 = \frac{m}{c}v = \frac{m}{c}D\varphi$

Combining this result with the linear dependence of $1/\varphi$ on m/c , it follows that at large m/c ,

$$I_1 = D/B \tag{16}$$

Defourneaux & Jacques used I_∞ to designate I_1 at large m/c

Combining Eq (16) with Eq (13), in which $\sqrt{2E^r}$ was eliminated via Eq (15), we get the ratio R , $R = (I_o)_{exp}/(I_o)_{theor} = \frac{0.475B}{(\Gamma-1)}$

Below we tabulate R as a function of Γ , using $B = 3.95$ for both cyclotol & octol (from Ref 7):

Γ	R
3	0.94
2.9	0.99
2.8	1.04
2.7	1.10
2.6	1.18
2.5	1.25

Clearly, agreement between theory & experiment is quite satisfactory in the expected range of $2.7 \leq \Gamma \leq 3$ (Ref 9) for these explosives

The impulse imparted to various metal, plastic and even foam plates by running detonations of EL506D sheet explosive were measured at SRJ (Refs 5 & 8) using a variety of measuring

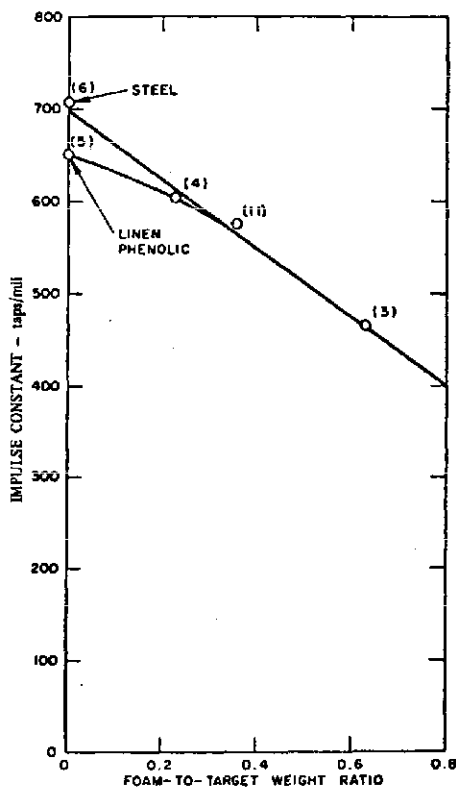

CONSTANTS FOR EL506D AS FUNCTIONS OF THE RATIO OF FOAM NEOPRENE TO TARGET WEIGHTS

(1 $\text{tap/mil} = 10^3/2.54 = 395 \text{ dyne sec/cm}^3$; numbers in brackets are the number of measurements for the particular data point; $m/c >> 1$)

TABLE 1: Comparison of Experimental & Theoretical Impulse Constants

Medium	Density of Medium (g/cc)	$(I_o)_{obs} \times 10^{-5}$ dyne sec/cm ³	$(I_o)_{theor} \times 10^{-5}$ dyne sec/cm ³
Rigid wall	—	—	2.8 (a); 3.0 (b)
Steel	7.8	2.9	—
Aluminum	2.56	2.5	—
Magnesium	1.74	2.45	2.3
Micarta	1.36	—	2.0
Neoprene	1.25	—	2.0
Neoprene foam	0.63	—	1.8
" "	0.40	2.4 (?)	—
Polyurethane foam	0.025	2.1 (?)	—
"vacuum"	0	—	0.39 (c)
Steel	7.8 (d)	4.9	4.8 (e)

- (a) Somewhat low—see discussion in previous section
- (b) From Eqs (13) & (15) for $\Gamma = 2.6$
- (c) From Eq (8) for $\Gamma = 2.6$
- (d) Had an 8-mil-thick Pb foil on the "free" HE face
- (e) From Eqs (12) & (15) with $m'/c = 1.3$

techniques. In all cases $m/c \gg 1$ & in all, but one experiment, the HE face not in contact with the test plate was in contact with air. The impulse constants, I_0 , based on these measurements are compared, in Table 1, with theoretical I_0 's, primarily those computed by Erkman (Ref 5)

It is seen that agreement between experiment and theory is quite satisfactory except for low density foams where experimental results may be uncertain

The writer has measured detonation velocities and impulses delivered for four different detonating gas mixtures. His results (quoted in Ref 5) are used for the comparison of experimental and theoretical I_0 's shown in Table 2. Each of the "slabs" of detonating gas, of necessity, had a thin plastic sheet on its "free face." Both slab thickness and plastic sheet thickness were varied

to get varying values of m'/c (see Eq (12)). The measured results in Table 2 show that I_0 increases as m'/c increases. The Gurney treatment (Eqs (12) & (15)) predicts this increase although the calculated I_0 's are in general some 50% greater than the observed I_0 's. A possible explanation for the larger-than-observed computed I_0 's may be based on the expectation that the computed γ 's may be too small. At the high CJ temperatures & low CJ pressures the detonation products may be more dissociated and/or ionized than we computed. More dissociation or more free electrons (ionization) will make γ approach 5/3, the γ for monoatomic gases

The I_0 's computed by Baum's method (Eq (1) corrected for γ (for gas detonations $\Gamma = \gamma = c_p/c_v$) are in reasonable agreement with I_0 's observed for the larger m'/c 's. This is fortuitous since in deriving Eq (1) it was assumed that

TABLE 2: Comparison of Measured and Theoretical I_0 for Gas Detonations
(In all cases $m/c \gg 1$)

Gas	m'/c	Theoretical $I_0 \times 10^{-5}$ (dyne sec/cm ³)			Obs $I_0 \times 10^{-5}$ (dyne sec/cm ³)	
		$1+2 m'/c$	Gurney (a)	Baum (b)		Erkman (c)
C ₂ H ₂ + O ₂ (d)	0.396	1.21	635	940	355	530
	0.47	1.25	660	940	355	450
	0.72	1.405	740	940	355	520 (e)
	0.96	1.495	785	940	355	762 (e)
	2.38	2.01	1055	940	355	727 (e)
	2.53	2.20	1160	940	355	910
2H ₂ +O ₂ +5He (f)	0.99	1.50	180	210	128	149 (e)
	1.65	1.76	210	210	128	170
	3.30	2.30	275	210	128	175
	6.60	3.10	370	210	128	205 (e)
	9.64	3.70	445	210	128	365 (e)
2H ₂ +O ₂ +10He (g)	1.17	1.57	131	140	103	115 (e)
	1.97	1.88	157	140	103	120
	3.94	2.48	207	140	103	131 (e)
	7.87	3.38	281	140	103	155 (e)
2H ₂ +O ₂ +15He (h)	2.19	1.96	145	115	<100	110 (e)

(a) Eqs (12) & (15) with the appropriate Γ , ρ_0 & D

(b) Eq (1) with the appropriate Γ , ρ_0 & D using 0.95 to convert from a "head-on" to a "running detonation"; m'/c assumed to be zero

(c) For air in contact with "free-face" of detonating slab of gas

(d) $\rho_0 = 1.18$ g/l, D = 2900 m/sec & $\gamma = 1.31$

(e) Single measurement

(f) $\rho_0 = 0.284$ g/l, D = 3440 m/sec & $\gamma = 1.39$

(g) $\rho_0 = 0.238$ g/l, D = 3400 m/sec & $\gamma = 1.47$

(h) $\rho_0 = 0.214$ g/l, D = 3450 m/sec & $\gamma = 1.53$

$m'/c = 0$, therefore computations based on Eq (1) should agree with measured results for small m'/c and not for large m'/c . Erkman's computations are not directly comparable with experiment since he assumed that the "free face" was in contact with air where in reality it was in contact with a thin sheet of plastic. Erkman's I_0 's presumably are lower limit values since the plastic sheet provides more "confinement" than air

Effect of Attenuators

By interposing an attenuator material of the appropriate *shock impedance* (See this Vol p 156) between the HE and the metal plate to be propelled, one can appreciably reduce the peak pressure at the attenuator/plate interface over that obtainable at the HE/plate interface in the absence of the attenuator. This, however, does not necessarily mean that the impulse delivered to the plate is reduced when an attenuator is used. Usually, an attenuator lengthens pulse duration so that the reduction in peak amplitude is compensated by an increase in pulse duration ($I = P_m t/2$ for a triangular pressure, and in general I is proportional to Pt). Thus, for thin attenuators, a simple-minded approach using Eq (13) (ie, $m/c \gg 1$ and assuming that $m_{att} \ll m_{pl}$) leads to the conclusion that the impulse delivered by a given explosive system is about the same with or without the thin attenuator. This means that the reduction in peak pressure (at least for triangular or rectangular pressure pulses) is almost exactly compensated by an increase in pulse duration. In practice, as shown in the accompanying Figure, attenuators do reduce the impulse (Ref 8) delivered. What the above simple-minded picture does not consider is that the attenuator "traps" some of the momentum delivered by the explosive. Stated differently, a thin attenuator does not transfer to the massive plate all the momentum, delivered to it by the explosive, even after making allowance for the mass of the attenuator. This does not mean that conservation of momentum is violated. It simply means that the attenuator retains (traps) more momentum than would be expected on the basis of its weight relative to the weight of the plate. Conversely, Altshuler et al (JETP 34, 614 (1958)) have shown that a thin metal plate, propelled across a void by an HE charge, delivers its momentum to a massive

target more rapidly than it acquired it from the HE. This produces a considerably higher pressure in the target than would be obtained if the target were in direct contact with the HE

Pulse Duration

For detonation products that obey a polytropic equation of state (probably also true for other equations of state), pulse duration is $t = nh/D$, where $1 \leq n \leq \infty$. Thus, for a triangular pressure pulse

$$I_0 h = \frac{P_m t}{2} = \frac{n \rho_0 D h}{2(\Gamma+1)}$$

From Eqs (13) & (14), with $m/c \gg 1$ & $m'/c \ll 1$,

$$I_0 = \sqrt{\frac{3}{2}} \left(\frac{0.578}{\Gamma-1} \right)$$

Solving for n we get

$$n \approx (\Gamma+1)/(\Gamma-1) = 2 \text{ for } \Gamma=3$$

Baum's calculations (Ref 2) for a "head-on" detonation against a rigid wall give $n \approx 1.5$, ie, the impulse obtained from Baum's Fig 142 $\approx 1.5 P_m h/D$

Essentially the same value of n is obtained by comparing the calculated impulse of Aziz et al (quoted in Ref 5) with a triangular pulse to give same area as the area under their $P-t$ curve. Thus it appears that the n based on Gurney is a little higher than the n 's of more sophisticated theoretical estimates

For a running EL506D detonation against a rigid wall, Erkman's calculations (Ref 5) lead to $n \approx 2.5$. Gurney-type calculations for this system give $n \approx 0.95(3.6/1.6) = 2.1$ in reasonable accord with Erkman. For gas detonations, agreement between Erkman & Gurney is also satisfactory as shown below (except for the oxy-acetylene mixture):

gas	γ	$n(\text{Gurney})$	$n(\text{Erkman})$
$C_2H_2 + O_2$	1.31	7.0	4.6
$2H_2 + O_2 + 5He$	1.39	5.8	5.4
$2H_2 + O_2 + 10He$	1.47	5.0	4.9

The disagreement between Gurney & Erkman n 's may be another manifestation of too low a computed γ for the oxy-acetylene mixture (see above)

Conclusions

Let us re-examine the general formula (Eq 9a) for impulse, I_0 , delivered by a unit thickness of an explosive charge to a massive ($m/c \gg 1$) incompressible plate

For an explosive slab, one of whose faces contacts a massive plate, and the other is in contact with air,

$$I_o = \rho_o D (\Gamma + 1)^{\Gamma-1} / \Gamma^{\Gamma} (\Gamma-1)$$

This equation shows that I_o will increase as $\rho_o D$ increases, eg I_o will be much larger for HE than for gas detonations because $\rho_{HE} \gg \rho_{gas}$. The impulse constant will also increase as Γ decreases, this means that for two HE's of comparable $\rho_o D$, the one with the lower Γ will deliver the larger impulse. Comparison of Eqs (8) & (9) shows that location of initiation can appreciably change the impulse delivered by a given explosive at a given m/c . Thus a system initiated at its free face delivers only 1/2 the impulse of the same system initiated at its midplane. On the other hand, comparison of Eqs (14) & (15), confirmed by experimental evidence, shows that there is rather little difference in the impulse delivered by "head-on" or "running" detonations. Experimental data, given in Table 2, show that confining the "free face" of a gas detonation (to keep the gas in place), even by thin layers of plastic, increases I_o over that expected from a free face in contact with air. Examination of Eq (12) reveals that the effect of m'/c becomes significant for $m'/c \geq 0.2$. Such values of m'/c are encountered in practice even with relatively thick "slabs" of detonating gas "confined" by thin layers of plastic on the "free face" of the slab

Attenuators may be used to reduce both peak pressure & impulse. They act as momentum "traps"

Computational procedures are presented for making estimates of pulse duration in terms of the quantity h/D . The factor, n , by which h/D is multiplied to get pulse duration is approximately $(\Gamma + 1)/(\Gamma - 1)$

Written by J. ROTH

Refs: 1) R. Courant & K.O. Friedrichs, "Supersonic Flow and Shock Waves" 1, 87, Interscience Publishers (1948) 2) F.A. Baum et al "Physics of an Explosion" Fizmatgiz, Moscow (1959), transl 1963, p 502 3) Ibid pp 525-28 4) Ibid pp 528-30 5) G. R. Abrahamson, SRI Int Rept 009-62 (1962), p 83 6) Ibid pp 48-55 7) M. Defourneaux & L. Jacques, Proc 5th Deton Symp (1970) pp 457-466 8) H.E. Lindberg & J. D. Colton, SRI Tech Rept AFWL-TR-

60-124 (1970) pp 25-59 9) J. Roth, SRI Lab Tech Rept 001.71 (1971) pp 5, 22 & C-1 10) Ibid p E-1

Impulse of a Primer. When a primer is fired, the force of detonation or length of "spit" is called impulse. It is measured by the maximum displacement of a mercury column resulting from the firing of the primer in an apparatus shown in Fig 15, p 50 of T.C. Ohart, "Elements of Ammunition," J. Wiley, NY (1946)

Impulse, Specific. Specific impulse defines the pounds of thrust produced in a rocket thrust chamber, rocket engine, or similar unit at the expenditure of one pound of propellant per second; the ratio of thrust to the propellant mass flow. It is one of the most used performance parameters in rocket technology. Because performance and weight are of prime importance, it is highly desirable to design for a high specific impulse. This makes possible a reduction in size of propellant tanks and a saving in the total wt of fuel & oxidizer carried aloft in these tanks

The most common equation for determining specific impulse is:

$$I_{sp} = \frac{F}{\dot{W}} \quad \text{where}$$

I_{sp} = specific impulse in lb/(lb/sec)

F = thrust in pounds and

\dot{W} = wt flow rate of propellant in lb/sec

Specific impulse must vary with changes in altitudes because both thrust & weight change with altitude and gravitational forces

Rocket power plants use the heat liberated by the reaction of chemical propellants, liquid or solid, as the source of energy. Specific impulse is more in liq propellant applications; it is difficult to accurately measure the propellant flow rate of solid-propellant-rocket thrust producing units. The average specific impulse is occasionally calculated for solid-propellant units on the basis of thrust, duration, and propellant wt, but there are other parameters that are more convenient. Modern rocket power plants are capable of obtaining specific impulse values between 240-250 lb/(lb/sec)

Refs: 1) G.A.W. Boehn, Fortune, Dec 1957, pp 166 & 170 2) Rocket Encycl (1959), 452-53

IMR Propellant. Improved Military Rifle (IMR) Propellant is a US single-base extruded proplnt for small arms ammunition. Its compn is NC (13.15%N) 97.4, tin 2.0 & diphenylamine 0.6%. Tin is present to act as an antilashing agent. Dinitrotoluene (6.75%) is added as a coating to moisture-proof the grains, also causes the first phase of the burning process to take place at a relatively slow rate, and has some antilashing action. A glaze of graphite is added to facilitate the uniform action of automatic loading machines and to avoid the development of large static charges in blending & loading

IMR Propellant and its many modifications in compn are manufd in the same manner as FNH (flashless, non-hygroscopic) & NH (non-hygroscopic) proplnts, except for the application of a coating of DNT and glazing with graphite. The coating is applied by rotating the grains in a sweetie barrel heated above the mp of the coating agent. The glaze of graphite is applied to the coated grains by tumbling in a rotating drum (Ref 2)

Lindner (Ref 1) has reported the following characteristics of a typical IMR Propellant:

Nominal Composition	
Cellulose Nitrate (13.15%N)	100.0
Dinitrotoluene (added)	8.0
Potassium sulfate (added)	1.0
Diphenylamine (added)	0.70
Volatiles (residual)	2.50
Physical Characteristics	
Density, g/cc	1.62
Thermochemical Characteristics (calcd)	
Flame Temperature, °K	
Isochoric	2835
Isobaric	2285
Force, ft lb/lb	331000
Unoxidized Carbon, %	3
Combustibles, %	59
Heat of Explosion, cal/g	868
Gas Volume, mole/g	0.042
Ratio of Specific Heats of	
Reaction Products	1.24
Covolume, cu inches/lb	28.9

IMR Propellants are used in caliber .30 & caliber .50 rifle ammunition

Refs: 1) V. Lindner, "Propellants," in K & O 8 (1965), pp 698-700 2) Anon, "Military Explosives," Dept of the Army Tech Manual TM9-1300-214 (1967), pp 10-6 to 10-7

Incendiary "Blue Pencil." This ingenious sabotage device, resembling a blue pencil in appearance, was invented by the Germans during WWI and used to cause fires on ships of the Allies. It consisted of a celluloid tube containing a long glass bulb filled with concentrated sulfuric acid. The lower part of the bulb was connected, by means of a very fine capillary, to a reservoir provided with a siphon below which was placed a charge of potassium chlorate

In operation, a saboteur breaks the upper tip of the bulb containing sulfuric acid and inserts the pencil into flammable material, such as cotton, sugar, explosives etc, preferably aboard a ship. After the tip is broken, air enters the bulb, allowing the acid to trickle down through the capillary into the reservoir, located below. As soon as a quantity of the acid accumulates, it discharges through a siphon arrangement into the receptacle containing the potassium chlorate and causes a very violent reaction accompanied by flash and flame

Ref: A.B. Ray, IEC, 13, 721 (1921)

Incendiary Bombs & Incendiary Agents. See under Incendiary Warfare

Incendiary Bomb Fires and Their Extinction.

As the modern incendiary bombs, containing magnesium or thermite, are hard to extinguish by water, several mixtures have been proposed for use in lieu of water. However, none of these mixtures has proved very effective

The US Office of Civilian Defense (OCD) during WWII stated that, in fighting incendiary bomb fires, the spread of the fire is more of a hazard than the bomb itself. If the bomb falls on a spot where it cannot start fires, the best procedure is to allow it to burn out. If it falls where it can start a fire, the fire-fighter should approach it as soon as possible, regardless of risk, attempting to remain behind some protective cover, such as a wall, in order to avoid injury in case the bomb explodes. From behind cover, a strong stream of water should be directed at the surrounding area and not at the bomb, which should be allowed to burn out. If no cover is available, the fire-fighter should operate from a crouching or prone position, to minimize the danger in case of an explosion

In extinguishing fires caused by phosphorous,

it must be remembered that, as soon as the water dries out, phosphorous will start to burn again. In order to prevent reignition the extinguished phosphorous, while still wet, should be scraped off; placed in buckets and dumped where there are no flammable materials. As phosphorous is very poisonous and causes extremely painful burns, all bodily contact with it must be avoided

The OCD recommended the use of sand or any of the "bomb-extinguishing" powders, because water can do more damage than good

If water is available only in small quantities, it is better not to use it at all because insufficient amounts of water would cause bombs containing thermite or magnesium to burn more intensely by supplying additional oxygen and the released hydrogen could add explosive fuel to the fire

Ref: Anon, *JChemEducation*, **20**, 59-60 (1943)

Incendiary Compositions and Compounds. See under Incendiary Warfare

Incendiary Devices. See under Incendiary Warfare

Incendiary Grenades. See under Incendiary Warfare

Incendiary Liquids and Gels. See under Incendiary Warfare and under Flame Thrower Liquids

Incendiary Missiles. See under Incendiary Warfare

Incendiary Mixtures. See under Incendiary Warfare

Incendiary Projectiles. See under Incendiary Warfare

Incendiary Shells. See under Incendiary Warfare

INCENDIARY WARFARE

(Incendiary Agents, Incendiary Compounds and Mixtures, Incendiary Devices, Incendiary Missiles, etc)

Incendiary warfare accomplishes the purpose of causing fires in enemy territory and burning

enemy personnel, animals, etc. In "modern" warfare, incendiaries are unfortunately also used for "strategical" purposes against civilians and cities which have no military installations. Incendiary warfare has assumed ever-increasing importance in recent wars

Enormous numbers of incendiaries were dropped by American aviation during WWII and, as the war came to an end, incendiaries exceeded explosives in the bombing of Japan. The total amount of incendiaries dropped by US aviation was 123,000 tons on Japan and 120,000 tons on Europe. Records of the late conflict prove conclusively that incendiaries, per unit weight, achieved greater damage to industrial and other structures than did high explosives

Stettbacher (Ref 7, p 129) gives the following figures on some of the heavy aerial bombardments of Germany and Japan during WWII

	Number of Bombs Dropped	
	High Explosive	Incendiary
Köln (Cologne), 6/28/1943	70,000	100,000
Berlin, 3/8/1944	10,000	200,000
Tokyo, 3/15/1945	6,000	325,000
German Hq, 5/25/1945	2,000	600,000

According to Stettbacher, the loss of life in Germany was not as heavy as the loss in buildings: 500,000 dead, or one per 4.9 tons of bombs dropped, against 3.6 million buildings partially or completely destroyed. The heaviest loss of life in a single raid was in Dresden—100,000 people or 20% of the population

It is the conviction of military authorities such as Major General A. H. Waite (Ref 9) that incendiary attacks broke the Japanese will to resist before the advent of the atomic bomb

Historical

Incendiary warfare is one of the most ancient methods of conducting war and was used as early as biblical times

The history of evolution on incendiary warfare may be divided into three periods:

- 1) before the invention of gunpowder and firearms
- 2) after the invention of firearms but before the introduction of aircraft for war purposes
- 3) after introduction of aircraft, particularly the airplane

First Period, Before the Introduction of the Gun

In this period of incendiary warfare, incendiaries were thrown first by hand and later by special machines, called catapults and ballistae. Bows and arrows were also used for throwing incendiary missiles. The earliest account of incendiary warfare may be found in the Bible, where mention is made of burning oil and ignited fireballs, consisting of resin and straw, that were thrown by both defenders and attackers of fortified towns. The Bible also mentions (Judges 15, 3-5) that Samson used foxes with firebrands attached to their tails to burn cornfields of the Philistines

Beside the Bible, the first reliable record of incendiary mixtures was given by the Greek tactician Aeneas, who, at about 350 BC, compiled the first European treatise on the art of war. He listed sulfur, pitch, pinewood, incense and tow as principal incendiary ingredients

Seven centuries later (AD 350), Vegetius, a Roman military authority, added resin, bitumen and petroleum oils to this list which indicates a significant advance in incendiary technique

All of these mixtures, however, were of low efficiency because they burned quickly and could easily be extinguished with water

According to Fisher (Ref 9), one of the earliest incendiary munition was the "*fire club*." It was a wooden club with sharp iron prongs attached to each end, the center being wrapped with incendiary materials such as tarred rope. The tar was lighted and the club hurled against a wooden structure, where the pointed prongs held the fire-bearing club in place against the wall or roof of the building until the fire spread. This device was described in 350 BC by Aeneas and was supposed to have been used before his time

Incendiary hand grenades were clay or glass vessels with a narrow throat. They contained a flammable mixture, which was ignited just before the vessel was thrown against enemy installations. The vessel broke, bringing the flaming mixture in contact with objects to be ignited

A device used as early as the 5th century BC consisted of a hollowed tree and a cauldron with burning coal, pitch and sulfur which were mounted on wheels and brought close to the enemy's wooden fortification. By means of a

bellows, air was forced across the cauldron and this projected flames against the wooden structure. This device may be considered a prototype of modern flame throwers

This crude machine was replaced by the "*blowpipe*," used by Roman armies. Incendiary balls, made of resin and sulfur, were forced through a tube and were ignited at the muzzle as they were ejected from the tube

A similar device was known later (about the 13th century) as "*flying fire*" (*ignis volatilis*). It consisted of a mixture of saltpeter 50, resin 25 and sulfur 25% & was shot from a reed or pipe

As soon as catapult machines were adapted to siege warfare, larger and more effective incendiary missiles were developed. The first incendiary missiles consisted of large stones coated with flammable materials, such as pitch, tar, sulfur, etc

Romans used the so-called "*firepot*," which was a kind of iron fire bomb (as large as 2 ft in diameter) filled with pitch, sulfur, bitumen, etc and either perforated or latticed so as to permit emission of flames from burning charges. One such bomb may be seen on exhibition in the Tower of London

"*Fire Arrow*" was one of the earliest incendiary weapons. It was a regular arrow with a charge of combustible material such as oakum, resin, sulfur, bitumen etc attached to it. This was ignited just before shooting. In order not to extinguish the flame during flight, the arrow had to be shot slowly and this limited its range

A much more effective mixture was the one invented in 668 AD by Kallinikos and called "*Greek Fire*" (see below) or "*Sea Fire*." The exact formula of the original composition is not known because the Greeks kept it a secret. However, it seems that it contained, besides the combustible materials such as naphtha, pitch and sulfur, some oxidizer, which could have been saltpeter. This mixture was liquid that was discharged against the enemy either from pots, tubes or siphons, installed in the bows of ships. The moment the liquid came in contact with the water it was ignited. This device was so effective that it caused several defeats of the Arabic fleets in the 7th and 8th centuries, of the Russian fleet in 941 and 1043 and saved Constantinople several times from invaders. Greek

Fire may be considered to be another prototype of the modern flamethrower introduced by the Germans in WWI. Later, the name "Greek Fire" was erroneously given to combustibles, which were ignited and then thrown by ballistae, or other machines, and were used on land. These compositions were semi-solid masses consisting of combustibles such as sulfur, pitch, naphtha, etc and oxidizers, such as saltpeter. They were also known as "Wildfire," and were used extensively by the Moslems during the Crusades and by the Moors during the conquest of Spain, eg, in the siege of Niebla in 1257.

Incendiary compounds were known in China in ancient times but the ones containing saltpeter seem to have appeared about the 13th century, when they were used successfully against the Mongols

According to the book of Marcus Graecus, entitled "Fire," which appeared about 1300 AD, the following composition was known in the 13th century in Europe: saltpeter 6p (66.7%), charcoal 2p (22.2%) and sulfur 1p (11.1%). It was used in two munitions, a "thunder bomb" and an incendiary rocket, called the "flying tunica." The latter consisted of a narrow cylinder filled with the above Black Powder" mixture which served as both propellant and incendiary for this prototype rocket

The idea of propelling incendiaries by means of a composition containing saltpeter, charcoal and sulfur is presumed to have been discovered by the Chinese. The introduction of substances, resembling the present Black Powder as rocket propellants and incendiaries, was a great improvement in incendiary warfare and for a while these weapons were of prime importance

Second Period, After Introduction of the Gun

With the invention of cannon (14th century) that used Black Powder as a propellant it was possible to hurl missiles much greater distances than by ballistae or catapults, thus causing greater damage to the enemy without resorting to incendiary compositions. And so, with the introduction of cannon, incendiaries became of secondary importance. However, attempts were made as early as the 14th century to shoot incendiaries from cannons

The first incendiary "shot" was a stone ball, preheated on a fire or by quicklime, and propelled from a cannon by a charge of gunpowder. In

order not to ignite the propelling charge prematurely, a wad of wet turf or earth was placed on top of the Black Powder so that the ball could rest on it until the deflagration of the propellant drove it from the cannon

With the introduction of iron balls (shot), the same procedure was followed. Hot iron shots were particularly effective against naval sailing vessels. Sometimes, even bullets from small arms were preheated and used as incendiaries

A variation of the preheated iron shot was the hollow projectile charged with incendiary mixtures, intended to bring the shell to a red hot temperature after impact. This device was not as effective, however, as solid iron balls, or the previously described missiles hurled by catapults

With the introduction (about the end of the 15th century) of hollow type projectiles charged with Black Powder, these "shells" also became, to a certain extent, incendiary missiles. This was due to the fact that, when such a shell burst, the flame produced by the explosion of the Black Powder could ignite any closely-located inflammable object

As Black Powder burns comparatively quickly, this shell could not be a satisfactory incendiary missile, unless part of the Black Powder could be replaced by slow burning compounds such as pitch, rosin, sulfur, bitumen, etc, and this was tried

However, much better results were obtained with improved "surface-burning" projectiles such as the following:

- a) "*Incendiary Ball*"—prepared by dipping a small iron ball in molten sulfur, wrapping it in oakum, redipping in sulfur and finally rolling it in fine Black Powder. The ball was wrapped in wire and its diameter had to correspond to the caliber of the cannon
- b) "*Incendiary Elongated Projectile*"—prepared by kneading a warm incendiary mix over a crossed iron frame, in a manner similar to the above
- c) "*Carcass*"—invented in 1672 and used until nearly the end of the 19th century, consisted of a thick, elongated, narrow sack containing pitch, oakum and Black Powder and enclosed in an open framework of iron straps. The composition burned with-

out scattering and its flame ignited surrounding materials

Other devices, such as "pitch rings" and "incendiary hoops" (Ref 9, p 113) also belong to the surface burning class of munitions

Military incendiary rockets, used in Europe in the 13th and 14th centuries, were forgotten until the British Col W. Congreve introduced an improved model at the beginning of the 19th century. The idea to resurrect rockets as incendiary weapons came to Congreve when he saw how successfully Indian troops used rockets against British troops at the end of the 18th century

Congreve's rocket, which was primarily an incendiary weapon, could compete successfully in accuracy with the cannon of that period and was used until the introduction of rifled barrels and breach loading, which improved the accuracy of artillery and increased its range to such an extent that the Congreve rockets became obsolete (about 1860)

Hale's rocket superseded that of Congreve. It was provided with a screw-like tail in an endeavor to give it a truer flight

With the exception of the Congreve and Hale rockets, very little progress was made in the 19th century in incendiary warfare and it might even be said that it was again forgotten. Incendiaries were not used during the Crimean or the American Civil Wars, but were reintroduced by the Germans during the Franco-Prussian War of 1870-1871. The Germans, using incendiary projectiles, burned several French cities and forced their capitulation

After that war, the Germans decided to improve the compositions and weapons used in incendiary warfare and especially to construct an incendiary projectile suitable for shooting from rifled, high-muzzle-velocity guns, invented in the 1860's. After many trials, they succeeded in developing several types of incendiary shells, some of which were used later in WWI. Other countries followed the German example and also developed incendiary shells

The following additional incendiary mixtures and devices were invented in Europe in the 19th century:

Mixture of Niepce consisting of powdered coal impregnated with carbon disulfide, gasoline or petroleum, was loaded into a bomb together

with a piece of metallic potassium or calcium phosphide, Ca_3P_2 and a small closed glass container with water. The impact of such a bomb broke the glass container and the water ignited either the K or Ca_3P_2 which in turn ignited the main incendiary mixture

Mixture of Fleck—similar to the previous one, but using metallic sodium as the priming substance

Fenian Fire (Liquid Fire)—consisted of a solution of yellow phosphorous in carbon disulfide. On evaporation of the CS_2 , the phosphorous self-ignited in the air and ignited nearby flammable objects

Darapski Projectiles were charged with petroleum, which was ignited by means of a mixture containing 3 parts of phosphorous dissolved in 1.3 parts of CS_2

Niklès Mixture (Feu lorrain- Lorrain Fire) consisted of a mixture of chloro-sulfuric acid (Cl_2SO_2) together with phosphorous dissolved in CS_2 . This mixture was ignited by introducing a small amount of ammonia

Gugot Mixture—same as above, but replacing the chloro-sulfuric acid with the bromo-sulfuric

Sophrionius Mixture consisted of 3 parts of concentrated H_2SO_4 and 2 parts of KMnO_4

In addition to these mixtures, it was proposed to use phosphorous trichloride, which catches fire on contact with either ammonia or ammonium hydrosulfide, NH_4HS

Third Period, Incendiary Devices Used After the Introduction of Aircraft in Warfare

Although aircraft was introduced as an auxiliary warfare weapon by various countries as early as 1910, their actual combat use did not begin until WWI. By this time, incendiary materials were used in the following devices: a) small arms ammunition b) shells c) trench mortar projectiles d) grenades and other hand weapons e) aircraft bombs f) flame projectors (described separately) and g) rockets

An excellent description of all of these weapons is given by Ray (Ref 4)

Only a brief resumé is given below

Small arms ammunition. Incendiary small arms ammunition, while carrying only a very small amount of material, has proved to be of the greatest value in effectively attacking highly flammable targets, such as aircraft, which might be filled with hydrogen or carry tanks

of gasoline fuel. Most incendiary ammunition is of regular caliber and fits standard machine guns. There are two classes of bullets which may have incendiary effect—*real incendiary* bullets, which usually function only on impact and *tracer incendiary bullets*, which begin to function either at the instant of expulsion from the gun or shortly thereafter. Although the primary use of tracer bullets is to aid in directing aim, some of them may have considerable incendiary action, provided the target is struck before the bullet ceases to "trace." Bullets used in WWI by the US Army carried the following incendiary materials:

a/ White phosphorous; b/ BaO₂ & Mg; c/ Ba(NO₃)₂, Mg, charred linseed oil, with an ignition composition consisting of red lead and Mg

One of the German perforating tracer-incendiary bullets carried incendiary material consisting of Sr(NO₃)₂ 75, Mg 13, Al 3, Fe 6, resinous material 3%, in the rear section. On top of this was pressed an igniting composition containing KMnO₄ 55 to 58, iron filing 45 to 42% and this was ignited by the flame produced by the propellant

Another German incendiary armor-piercing bullet contained igniter and incendiary compositions in the front section. The advantage of this type of bullet was that the burning composition in front of and around the armor-piercing shell of steel was more likely to ignite gasoline from a perforated tank than if the composition were in a separate container, which might break away from the bullet on impact. The priming or igniting composition which ignited on impact consisted of Mg, KClO₃ and Sb₂S₃, while the incendiary composition contained Mg, Al, Ba(ClO₃)₂, sulfur and a little NC

During WWII, the following incendiary and tracer small arms ammunition were used by the US Armed Forces:

a) **Incendiary Ammunition (I)** was used primarily against aircraft as a means of setting fire to enemy planes. The straight incendiary bullet has an incendiary charge in the nose and in a steel sleeve ahead of the lead slug. The incendiary mixture consists of barium nitrate and magnesium-aluminum powders. The bullet functions on impact, the mixture being ignited by the heat and sparks of impact. The gilding

metal jacket is torn open and the incendiary composition burns for 10 to 40 milliseconds. Incendiary fillers weigh from about 20 grains, for cal .30, to 75 grains for cal .50 bullets. One of the most effective bullets is the cal .50 M23, a 500 grain bullet which is fired at 3400 ft/sec

b) **Armor-piercing Incendiary Ammunition (API)**, has the lead point filler replaced by an incendiary composition. It is also used primarily against aircraft. The API bullet is similar to (I), except that the incendiary is ahead of the steel core. The cal .50 API bullet contains 15 grains of the incendiary mixture consisting of barium nitrate and aluminum-magnesium powder. This mixture ignites on impact

It is estimated that in WWII 50% of the planes lost to anti-aircraft fire and approx 75% lost to enemy aircraft were brought down by incendiary ammunition

c) **Armor-piercing Incendiary Tracer (API-T)**, similar to API but having a tracer mixture in the rear of the bullet. Caliber .30 ammunition is expected to trace for about 1200 yards and caliber .50 about 1800 yards. A longer trace has been developed for .50 ammunition (2500 yards). A dim trace (dim for the first 200 yards to prevent dazzling the gunner) has also been developed for .50 ammunition. The incendiary composition for calibers .30 and .50, which ignites on impact, consists of barium nitrate and aluminum-magnesium powder, the tracer composition consists of strontium peroxide and nitrate, magnesium and other ingredients. The tracer is ignited by means of a barium peroxide and magnesium powder mixture, which is pressed on top of the tracer mixture at 70,000 psi. The pressing is done by a step punch in order to create a large surface to present to the hot propellant gas which ignites the barium peroxide-Mg mixture

For .50 caliber bullets with a trace of 2500 yards, a slower burning tracer composition containing Sr(NO₃)₂, KClO₄ and Mg is usually used

In the so-called "*night-tracer cartridges*," which neither blind the gunner nor reveal his position to the enemy, a dim igniter (essentially SrO₂, Ca resinate and Mg) burns for the first 200 yards for the .30 and .50 caliber bullets. A tracer bullet for .45 caliber submachine gun traces for 160 yards

d) **Tracer Bullet (T)**, similar to ordinary ball bullets, but having the rear half of the lead core replaced by igniter and tracer compositions, which are essentially the same as in the API-T bullets. There are tracer bullets for .30 and .50 caliber rifles

A special .50 caliber bullet, called "*M21 head-lite tracer*" was developed to satisfy the air force requirement for a bullet to simulate a ball of fire. The object was, for psychological effects, to make the enemy think that he is under fire from much larger caliber weapons than small arms. For this, the standard M1 tracer bullet is modified by replacing the usual igniter and tracer composition with strontium peroxide alone. Although in this case, the tracer distance is reduced from the usual 1800 yds to about 600 yds, the visibility is about three times that of the usual tracer bullet

Among foreign ammunition, the Japanese caliber .50 "*explosive-incendiary*" bullet is of interest. It was provided with a point-detonating fuze and a charge of high explosive, with the incendiary filler placed behind the explosive charge. After the projectile penetrated the target, the explosive filler was detonated, the jacket or shell shattered and the incendiary composition ignited. The composition of the incendiary mixture was $\text{Ba}(\text{NO}_3)_2$ 38, NaNO_3 20, Mg powder 36, Al powder 6% (Ref 9, p 58)

e) **Incendiary Shells.**

The first satisfactory incendiary shells suitable for firing from modern high-muzzle-velocity, breach-loading, rifled cannon were developed by the Germans before WWI

It should be noted, however, that in modern warfare, the incendiary-loaded artillery shell has become of secondary importance. This is because good targets for incendiaries are nowadays seldom found within range of artillery. If such targets are found, they usually can be destroyed more readily by incendiary aircraft bombs than by artillery. Thus, the effective use of the incendiary shell is narrowed to certain specialized targets and to situations in which the air force cannot be easily utilized

For these reasons, many types of incendiary shells that were standard during WWI have since been discarded. Nevertheless, it is interesting, from a historical point of view, to give a short description of shells used during WWI because at

that time such shells played an important role

During WWI, shells were produced ranging from 37mm to 17.5cm. The smaller sizes were used for attacking aircraft from the ground while the larger calibers were used against all sorts of ground targets. There were tracer shells which had appreciable incendiary action over a considerable portion of their trajectory. There were also incendiary shells which did not function as incendiary devices until at the moment of explosion when the incendiary material was ignited and scattered

The consensus regarding incendiary shells was that the small caliber tracer-incendiary shell was quite effective against aircraft, but that the larger type, designed for use against ground targets, was not as successful

A common type of tracer-incendiary shell, carrying red lead and magnesium, was produced in the US in 75mm and 3" sizes. It was used principally for shooting down balloons. This shell was of very simple construction—just a cylinder with a threaded neck, in which a fuse was inserted, and six vents below the threaded part. The fuse charge ignited the primer which in turn ignited the incendiary mixture and the incandescent products of combustion were emitted through the six holes in the head. The smoke from this combustion left a definite trace of the projectile, and the hot gases evolved for 6 to 25 sec possessed efficient incendiary action

A more complicated tracer-incendiary shell was used by the British and Germans. In this shell. (usually 75mm), the flash from the time fuse was transmitted through a tube (located in the center of the cylinder and extending from the top, near the fuse, almost to the bottom of the shell) to the primer. The primer ignited the incendiary composition, containing Mg, $\text{Ba}(\text{NO}_3)_2$, and binder with or without $\text{Sr}(\text{NO}_3)_2$, and blew out the base of the shell. This resulted in emission of flame from the base of the shell, lasting about 15 seconds

There also existed several models of shells designed solely for incendiary effects. Most of them contained thermite with inflammable organic materials. Others contained phosphorous, sodium, etc

The British designed a 77mm shell which carried thermite ($\text{Al} + \text{Fe}_2\text{O}_3$) as an incendiary

material and ophorite ($Mg + KClO_4$) as an igniting and expelling charge. This type of shell acted not only as an incendiary, but also as shrapnel producer, because it scattered hot metal and slag produced by the thermite reaction

For larger sizes, eg, 15.3cm, a shell was designed which contained units of thermite or other incendiary materials held in perforated cases. These units were ignited from a central tube and expelled from the front of the shell by the explosion of the powder charge located in the base

The Germans developed a 15cm shell, for use against ground targets, which contained 12 or more celluloid cylinders surrounded by yellow phosphorous imbedded in paraffin. A central tube of Black Powder was used as a bursting charge

The largest incendiary shell used during WWI was the German 17.5cm "*Minenwerfer*," described in detail in Ref 4, p 716

A 7.7cm shell developed by the Germans for use against aircraft scattered steel slugs and flaming incendiary units on bursting, called "*flaming onions*" by allied aviators

Towards the end of WWI, the US Army developed a base-opening shell, which on functioning, ignited and expelled a consolidated large mass of incendiary material

During WWII, the US Army retained only the white phosphorous shell, which was not officially listed as incendiary ammunition. Yellow phosphorous also served as a smoke and anti-personnel agent with only incidental incendiary value—it easily ignites light combustible material. As an example of such shells, Fisher (Ref 9, p 53) describes the 81mm smooth-bore mortar shell. This shell weighs 11.5 lbs, has a range of slightly under 2000 yds and carries 4 lbs of solid yellow phosphorous. On impact, the nose fuse detonates the burster charge of Tetryl (placed in a thin-walled tubing, extending into a cavity in the phosphorous), which breaks the shell and simultaneously ignites and scatters the burning phosphorous

A 4.2" chemical mortar shell was also used for incendiary purposes. It contained a burster charge of Tetryl, placed in thin-walled tubing extending into a cavity in the phosphorous. The Tetryl broke the shell and simultaneously ignited and scattered the burning

phosphorous (Ref 9, p 53). These shells were mostly used in trench mortars

The Japanese Army incendiary shells were used in 75mm guns and 90mm mortars. The incendiary material consisted of rubber pellets impregnated with a solution of 88% phosphorous and 12% carbon disulfide. A burster charge of picric acid scattered the incendiary pellets, which ignited on exposure to air and burned for about five minutes. These shells were only effective against readily ignitable materials (Ref 9, p 53)

Antiaircraft Incendiary Shells. The antiaircraft incendiary shells used during WWI were very successful against hydrogen-filled airships but did little damage to airplanes. The problem of successfully attacking airplanes by incendiary shells from the ground has not been solved up to the present time, although the Germans and Japanese developed some ground antiaircraft shells, for example, the following:

German 20mm Incendiary Shell—carried an incendiary composition containing phosphorous, thermite and other compounds. This charge was pressed into the lower part of the shell by means of a stepped ram. A charge of HE placed on top of the incendiary charge was detonated by means of a booster initiated by a fuse. This shell, as well as the 20mm Japanese shell, described below, proved to be more successful in air-to-air than ground-to-air firing

German 88mm and 128mm Antiaircraft Shell. Used during WWII. The incendiary pellets were designated as FK44 and FA252. The FK pellet supposedly weighed about 27g and was approx 15mm in diam and 30mm in length. The pellet was said to consist of a detonator, a striker and a diaphragm. Three holes allowed gasoline to enter the pellet and to create a hydrostatic head as the pellet entered the fuel tank of the target. The hydrostatic head detonated an explosive filler of pressed PETN/wax/Al. The pellet was intended to blow a hole in the fuel tank large enough to prevent resealing and to ignite the gasoline. The 88mm carried 72 pellets and the 125mm, 124 (Ref 16)

Other German Incendiary Shells. German munitions also included incendiary core fragmentation shells. These incorporated a central flash tube which ignited the incendiary filling of each fragment prior to detonation. The shell

functioned in a manner similar to the Italian shell described below. The materials used for the core are as follows:

Ingredient, %	B1	Dag-			
		Dag-Small	Powdered	B19S	B19K
Ba(NO ₃) ₂	49.0	—	—	—	—
BaO ₂	—	70.0	69.2	8.4	3.5
Fe ₂ O ₃	—	—	—	62.5	65.8
Al, flaked	—	25.0	25.0	20.8	21.9
Al, powder	—	5.0	5.0	—	—
Mg/Al alloy	50.0	—	0.8	8.3	8.8
Necresil	1.0	—	—	—	—
NC*	—	—	—	—	—

*NC added as a granulating material in the form of collodion (Ref 16)

Italian Incendiary Shell. Italian anti-aircraft incendiary pellet projectiles, in WWII, consisted of a 76 or 90-caliber shell loaded with a number of incendiary-filled cylindrical pellets. The pellets were ignited by a flash from a central flash tube. A delay mixture activated a secondary explosive in the base which broke the shell into flak. Composition of the incendiary filling is not given in Ref 16

Japanese 20mm Incendiary Shell—carried a small incendiary charge of Ba(NO₃)₂ 50, Mg 40 and Al 10%

Japanese Incendiary Shells of Larger Calibers were loaded with yellow phosphorous and produced large spectacular aerial bursts, but their value was probably more psychological than destructive to aircraft (Ref 9, p 55)

Japanese 120mm Incendiary Projectile contained 48 steel pellets embedded in a canister filled with white phosphorous. Each pellet had an annular cavity to increase the amount of phosphorous that could be retained by each pellet. The shell was exploded by means of a bursting charge of HE, fired by a point-detonating fuse

Trench Mortar Projectiles. During WWI, the following trench mortar projectiles were developed: 3" and 4" Stokes bombs and 8" Liven's drums. They were used mostly to destroy grass, shrubbery or camouflage which could act as a screen for enemy movements, to clean out woods, to demoralize the enemy during gas projector attacks and to indicate the range in night attacks

The Stoke's bombs were loaded for best results with about 7.5 lbs of thermitite as the incendiary compound, and ophorite as the explosive igniter. The ignition was started by a time fuse

The 8" Liven's incendiary drum was a metallic container, 20" long and 7 5/8" in diameter, resembling an ellipsoid in shape. It was closed at one end and open at the other. It contained balls of cotton or jute impregnated with "solid oil" (thickened oil), prepared by treating a mixture of fuel oils (bp 170-225°) with sodium stearate. The lighter part of the oil mixture was readily ignited by the flash from the explosive charge, which was loaded in a central tube, and this ignited the heavier oils. One end of the drum was fitted with an impact fuse which caused the drums to explode on landing, and to scatter burning material over an area 50 yds in diameter

Some Liven's drums contained cotton waste impregnated with a mixture prepared as follows: TNT was dissolved in benzene and fuel oil and gas tar oil and a solution of yellow phosphorous in CS₂ were added. The mixture was insensitive to shock, had a very low coefficient of expansion (0.0174 per °C between -10° and 55°) and a low vapor pressure

These drums were projected from a mortar-like, smooth-bore barrel, called the Liven's Projector. It had an 8" bore and was 37.5" long. A propellant charge ignited by an electric primer was used to obtain a maximum range of 1450 yards

Grenades and other small devices. Small portable incendiary devices, such as hand grenades, are very valuable because they can easily set fire to flammable targets. These grenades can also be used for throwing into dug-outs and for destroying material abandoned in retreat, such as damaged planes

The following grenades were used during WWI:

Phosphorous grenade consisted of a sheet metal can filled with yellow phosphorous and provided with an explosive device. Although the primary aim of such grenades was smoke-production they were also incendiary weapons

Thermitite grenade consisted of a cylindrical sheet iron container filled with thermitite (about 600g) slightly moistened with sodium silicate. In the center of the thermitite was a cavity in which

was inserted an igniter bag of $\text{Al} + \text{Ba}_2\text{O}_2$. Strands of a quick match connected the igniter bag to a piece of Bickford fuse

Thermite-gelled oil grenade was developed with the idea of combining the advantages of thermite and gelled oil. The former develops temperatures high enough to melt metals, while the latter produces a long duration flame. The grenade consisted of a heavy cardboard container whose lower half had a celluloid container filled with gelled oil, while the upper half contained thermite with a celluloid binder (4% by weight of celluloid dissolved in a small amount of acetone). The grenade was fired by withdrawing the safety pin and releasing the "bouchon" firing handles. The spit of the fuse ignited the booster, which set off the igniter ($\text{Al} + \text{Ba}_2\text{O}_2$) and then the thermite. The resulting molten iron and slug penetrated and ignited the celluloid container with the gelled oil

During WWI, the Germans developed several portable incendiary devices consisting of a metallic or pasteboard tube filled with mixtures of oxidizer and combustibles (eg, KNO_3 62.5, sulfur 27.0, carbon 10.5%) and fitted with a friction-igniting device. Some of these devices were of larger size, containing as much as 1670g of the above mixture. In practice this device served either as an incendiary or smoke producer, depending on circumstances

The French developed an incendiary can, for throwing into trenches or dugouts, containing about 3 liters of petroleum oil and weighing about 7 lbs. It was provided with a friction igniting and exploding device

Although uses for incendiary grenades are limited, they were still used during WWII. The present incendiary grenades are of two types: 1) standard types, regularly produced and supplied, and 2) improvised frangible grenades. Standard grenades, although normally thrown by hand to a distance of 75 to 100 feet, can also be fired from rifles or grenade launchers up to 750 ft. When projected from rifles, using a special cartridge, the incendiary grenade is a valuable weapon for attacking tanks and other vehicles

Standard grenades. According to Fisher (Ref 9, p 55-6), there are two kinds of standard grenades used at the present time by the US Armed Forces, a/ *thermite* type and b/ *phosphorous* type

The *thermite grenade* consists of a steel canister 2 1/2" in diameter and 4 3/4" high provided with vents in the upper part and containing about 20 oz of thermite. In the top there is a "bouchon-type" fuse with a lever held in unarmed position by a safety pin. A plastic cup with igniter (starter) composition is attached to the lower part of the fuse. When the safety pin is removed, release of pressure against the igniter fuse lever permits the firing pin to strike a primer (after a delay of about 2 seconds), which results in ignition of the starter composition followed by that of the thermite. Combustion continues for about 30 seconds and develops sufficient heat to burn difficultly ignitable materials and to melt metals (even steel). Such grenades may be used for the destruction of guns, airplane equipment, etc about to be abandoned

By attaching an exterior Primacord detonator, the grenade may be exploded during burning of the thermite, thus scattering particles of molten iron a distance of about 75 feet

A US Army, WWII, incendiary grenade, AN-M-14, contained a thermite composition designated as "Therm-8" having the following ingredients: Thermite* 70-81%, $\text{Ba}(\text{NO}_3)_2$ 14.85-15.15, Al flake 1.01-0.99, Al grained 2.77-2.83, sulfur 0.89-0.91, castor oil 0.303-0.297 (Ref 15)

**Thermite has the following composition (parts by wt): Al (granular) 1.0, Iron oxide, magnetic (Fe_3O_4) 2.75*

A *phosphorous grenade* is constructed in the same manner as the thermite grenade, but functions as a bursting rather than a burning munition. On exploding, solid pieces of phosphorous are scattered up to a distance of 75 ft and burn for about 30 seconds. This grenade may be used for setting fire to easily ignitable material, such as gasoline, etc

The Japanese, during WWII, used two kinds of grenades, those filled with yellow phosphorous and those containing rubber pellets impregnated with phosphorous-carbon disulfide solution (Ref 9, p 56)

Frangible grenades. According to Fisher (Ref 9, p 56) and Ohart (Ref 10, p 359), the frangible grenade is an ordinary small glass bottle filled with gasoline (preferably thickened) or other combustible liquid and tightly closed.

Some type of impact igniter is attached by means of a tape to the upper part of the outside of the bottle. The bottle breaks when thrown against a tank or other hard-surfaced object and the igniter sets fire to the liquid. If well aimed against a tank, the liquid may penetrate inside the tank and burn the personnel.

The so-called *Molotov cocktail*, used for the first time during the last Spanish Civil War, also belongs to the frangible type of grenades.

Aircraft Bombs. It was recognized as early as 1910 that bombing from airplanes was of the greatest military importance. It was also recognized that incendiary bombs possessed great potential destructive power. The first successful incendiary bombs were developed by the Germans during WWI and dropped for the first time (1915) from airships over London. The Allies soon followed their example. During WWII, the US Air Force used such bombs very effectively, more so than the Germans, to burn out most of the large German and Japanese cities.

The bombs developed and used from 1915 up to WWII may be divided into the following types:

- 1/ Large bombs, known as *intensive type*, which practically burn up where they are dropped
- 2/ Large bombs, known as *scatter type*, which on functioning, scatter a number of incendiary units over a wide area
- 3/ Small unit bombs, called *darts* in the USA, which can literally be rained down upon a target

Most of these bombs are described in detail by Ray (Ref 4, pp 718-720) and only a short summary is given below

1/ *Intensive type bombs* comprise a large variety of models and carry practically all types of incendiary materials. The most satisfactory bombs developed during WWI consisted of thermite and large amounts of highly inflammable materials. The first bombs dropped in 1915 by German Zeppelins were of the intensive type. These bombs weighed 20 lbs and contained gasoline, thermite and an ignition mixture. They were wrapped with tow rope impregnated with tar and $\text{Ba}(\text{NO}_3)_2$. A percussion fuse served to cause the first ignition. These bombs were dropped from airships only

A later type of German bomb weighed 10 or 20 lbs and could be dropped either from airplanes or airships. It consisted of a sheet-metal torpedo-shaped container filled with an incendiary composition consisting of a pasty mixture of gasoline and paraffin with or without K perchlorate. The igniter was a mixture of Al and Fe filings with $\text{Ba}(\text{NO}_3)_2$, placed in a central tube and a charge of Black Powder was used to disrupt the casing and scatter the incendiary material. The bombs were wrapped on the outside with tow rope and then were shellacked.

The German example was followed by the French and British and later by the Americans.

A 20 lb bomb developed by the French was called "*Chenard*" and was considered to be successful. It contained a mixture of rosin and celluloid as the principal incendiary material. The bomb ignited while falling and reached the target in flames.

The British developed several intensive type bombs, such as the one filled with gasoline and ignited on impact by a Vêry cartridge but none was as successful as the small unit bombs developed by them later.

The US developed a 50 lb bomb which consisted of a sheet zinc body in the shape of a prolonged ellipsoid, filled partly with thermite (bound with Na silicate) and partly with gelled oil. The bomb was provided with an impact fuse connected to an igniter. When the bomb functioned on landing, the thermite was ignited and burned through the casing. The enormous amount of heat liberated liquified and ignited the gelled oil to spread the conflagration.

2/ *Scatter type bombs.* A 20 lb impact-functioning bomb developed by the French, contained as incendiary material cotton impregnated with a flammable liquid mixed with K chlorate and paraffin. As a combination igniting and explosive material, a sulfur-bound thermite (Thermaaloy) was used. Thermaaloy can act as a mild explosive as well as a great heat producer, when ignited under confinement. Thus on ignition of the thermite the bomb exploded, scattering burning thermite and the impregnated cotton. However this bomb was not considered a great success.

A 40 lb air-burst bomb developed by the British was filled with yellow phosphorous and

was used against observation balloons and ground targets

A 50 lb "scatter-type" bomb developed by the US is identical with the intensive type as far as outside dimensions are concerned. Incendiary material to be scattered consists of either cotton-waste balls impregnated with inflammable materials, such as turpentine or CS_2 , or gelled oil held in small celluloid containers. When the bomb lands, ignition and ejection of the units are effected by an explosion of Black Powder in the nose

This type of bomb was never used because by the time it was fully developed the small unit bombs, or "darts," were considered more effective

3/ *Small unit bombs.* The British originated the idea of dropping a large number of small unit bombs instead of one large scatter type bomb and consequently developed the 6.5 oz bomb

In its action the little bomb resembles that of a mortar and projectile. It consists of a cartridge very much like a shotgun shell which is functioned on impact by a strike point in the base of the body of the assembly. The flash from the cartridge ignites an incendiary charge of "flaming thermite" consisting of 11 pts of thermite and 6 pts of $Ba(NO_3)_2$. The little bombs were loaded into containers hung underneath an airplane in such a manner that containers could be released individually. Each container carried 144 or 272 bombs and the total number of bombs carried by a single plane was 16,000

Following the British idea, the US Army developed two types of small bombs and called them "darts."

The first type, primarily intended for use against crops and forests, burned with a large flame but did not have great penetrating power. It was in the shape of an elongated shotgun shell and contained an incendiary mixture consisting of $Ba(ClO_3)_2$ 54, rosin 16, Al 14 and asphaltum varnish 16%. The primer was a mixture of reduced iron and $KMnO_4$

The second type, intended for use against buildings, contained a thermite-gelled oil mixture as an incendiary. This bomb had sufficient penetrating power to pierce a roof

The unit bombs were not produced in quantity

during WWI but, in modified form, they found wide use in WWII

Bombs used during WWII

A most important contribution to incendiary warfare was made by the Germans, who conceived the idea of using the magnesium alloy, called "Electron" (see below) for the construction of bombs. Although this bomb was invented as early as 1917, it was not used in WWI, but was first employed in the military operations of WWII, beginning in 1939 (See Elektron Bomb in Vol 2, pp B234 to B237). It caused considerable damage to London and other British cities during the early part of WWII but later in the war when the Allies, especially the US, developed their own incendiary bombs of better quality and in larger quantities than those of Germany, it was the Germans and their Japanese allies who suffered most. The Italians were spared incendiary warfare

The US Chemical Warfare Service produced four types of incendiary bombs during WWII. One type, the magnesium bomb, was copied after European designs, while the other three types were developed, after Pearl Harbor, entirely by American scientists

The M50A2 4 lb Incendiary Bomb was similar to British and German models. It was hexagonal in shape and had a body of cast-magnesium alloy (1.25 lbs), an iron nose plug and a sheet-metal tail. It was 21.3" long and 1.69" across the flats. It was filled with 265 grams of "Therm 64-C," which has the following composition: Al (granular) 16.0, Al (flake) 9.0, Fe_3O_4 (iron scale) 44.0, $Ba(NO_3)_2$ 29, sulfur 2.0%. This filling is ignited by a "first fire" composition (igniting mix). It burns fiercely for one minute (without consuming outside oxygen) at $2985^\circ C$ and melts and ignites the magnesium alloy of the casing. Some of the magnesium vaporizes and the Mg vapor mixed with air burns with a very hot flame ($2000^\circ C$). The magnesium continues to burn for a maximum time of 10 minutes and due to the fact that it requires little outside oxygen (0.9p per 1p of Mg) it can burn even in closed buildings. Fires produced by such bombs are difficult but not impossible to extinguish. The disadvantage of such bombs lies in the fact that the fire is mostly confined to a very limited area. These bombs are generally released in clusters

In order to spread fires over a larger area, an explosive element is sometimes added to the bomb so that when it explodes, after being partly burned, it scatters burning pieces over an area having a radius of as much as 50 ft. This greatly hampers fire-fighting because it is never known just when the bomb will explode and cause injuries to fire-fighting personnel. In the US **M50XA3** bomb, 36 grams of tetryl is used as the explosive charge and a delay fuse and detonator is included in the ensemble (Ref 10, p 235 & Ref 15, parts III & V)

The **M-69** (6 lbs) incendiary bomb is a hexagonal case of sheet steel 19.5" long and 2.9" across the flats. Its central portion contains a charge of 2.2 lbs of "gelgas" or "Napalm" held in a cheese cloth sack and an ejector-igniter charge (placed near the fuse) of 0.4 oz of Black Powder and magnesium. This was later replaced by a Tetryl booster surrounded by phosphorous, serving as igniter for the gelgas or Napalm. Attached to the outside of the bomb are four lengths of green-colored cotton gauze, 40" long and 3" wide. These break free as the bomb starts to fall and act to stabilize the fall and to provide drag, so that the descent slows down to 225-250 ft per second. This prevents the bomb from smashing to pieces when it lands, yet the bomb has sufficient force to pierce tile, slate, wood or galvanized iron roofs. After the bomb lands, the impact activates a delay fuse which, after 3 to 5 seconds delay, ignites the "igniter-ejector" charge. This ejects the sack with burning gelgas or Napalm from the tail of the casing to a distance of 75 to 200 feet. The gel scatters around as "gobs" of fire, which cling to surrounding objects and continue to burn for the next 8-10 minutes. The bomb may be fused either for delayed action so as to permit penetration into structures before functioning, or for immediate action so as to scatter flaming material over roofs or other surfaces

In the 6 lb **M69X** bomb, 0.4g of the jellied gasoline was replaced in the nose of the bomb by a charge of Tetryl to act as a burster charge. The bomb is so constructed that when the main ejection-ignition charge forces the "gelgas" from the bomb case, a delay fuse leading to the Tetryl charge is also ignited. After a delay of from 1 1/2 to 6 seconds, the explosion of

the Tetryl fractures the entire nose of the bomb, producing more than 400 fragments. This bomb acts not only as an incendiary, but also is effective against personnel (Ref 15, parts III & V)

In the **M69-WP** bomb, 0.4g of the gel contained in the nose of a regular **M-69** bomb was replaced with a plastic cap containing white phosphorous. When the "gelgas" is ejected from the casing, the force of explosion breaks the cap and scatters the WP about the area. The smoke produced by WP obscures objects, makes breathing difficult and hampers fire-fighting

All the types of bombs described above were packed together in closed containers (containing from 25 to 100 bombs) which fell like a single bomb from a plane and broke open a few thousand feet above the target, releasing the individual bombs in a tight pattern. The hexagonal shape of these bombs allowed packing them in larger quantities per unit space (Ref 15, part III)

Bombs Released Individually weigh 70 lbs and up, for example, the **M47A2** and the **M76** US bombs. These were designed for precision bombing. A particular advantage of such bombs is their ability to penetrate heavily-roofed structures that would resist the impact of light (cluster) bombs. When dropped from high altitudes, these bombs have impact velocities of about 1000 feet per min and may pass through reinforced concrete up to 15" thick

The **M-47** incendiary bomb weighed approx 70 lbs and consisted of a sheet-steel cylinder with a rounded nose and tail. It was 45" long and 8-1/8" in diameter and was filled with jellied gasoline. Originally, a Black Powder central burster was used, but it was not as satisfactory as the later model with a TNT-Tetryl burster, which was surrounded by white phosphorous used as the igniter for the gasoline gel. This bomb was initiated by a nose fuse

The **M76** bomb, also called "goop bomb" or "Blockburner," was the largest incendiary bomb used in WWII. It weighed 475 lbs. It consisted of a metallic cylinder with rounded nose and tail and was loaded with 180 lbs of "pyrogel" (see below). It was provided with standard nose and tail fuses and a standard igniter and burster. On reaching the target, the burning pyrogel was scattered by the force of the

bursting charge to a distance of 150 to 500 ft and burned with an intensely hot flame. The pyrogel mixture combines the good features of both jellied gasoline which scatters and penetrates into hard-to-reach corners of structures, and of magnesium which concentrates a white-hot flame on the target (Ref 15, parts IV & V)

For other standard incendiary bombs (1946) see Ref 15, part V and table of contents of part I. For incendiary compositions, both experimental and standard, see part II

Jettisonable Airplane Fuel Tank Bombs.

Another type of US incendiary bomb was the converted auxiliary airplane fuel tank of 75 to 300 gallon capacity. They were filled with jellied gasoline and provided with a fuse and an igniter. Such bombs spread fire over a large area and were very effective against Japanese targets (Ref 10, p 239 & Ref 15, part IV)

In addition to the "electron" bomb previously described, the following foreign incendiary bombs used in WWII might be mentioned:

a/ *German Incendiary-Explosive Bomb* was a magnesium incendiary bomb which was lengthened in the nose to provide space for a high explosive charge. The total weight of the bomb was 5 lb and the total length, including the tail, was 21". On landing, the incendiary part of the bomb ignited but the explosive part remained intact and exploded up to 7 minutes later. In some bombs, the explosive part became detached on landing and rolled away from the incendiary section

b/ *German 50kg Incendiary-Explosive Bomb* consisted of a casing, 30" long and 8" in diameter, which contained, besides the incendiary charge, a 12 lb charge of TNT lodged in the nose. On impact, the bomb ejected 60 small metal containers with thermite-type filling and 6 larger tumbler-shaped fire pots containing a magnesium-type filling. This was followed almost immediately by explosion of the TNT charge

c/ *German 50kg Phosphorous Incendiary Bomb* consisted of a casing similar to the previous bomb, filled with a mixture of yellow phosphorous 86.5, benzene 13.1 and polystyrene 0.4%. The bomb was split open on impact by the bursting charge and the incendiary was scattered in the form of a sticky self-igniting liquid

d/ *German 50kg Petroleum Solvent Incendiary Bomb* was similar to (c) but contained petroleum solvent 87.7, polystyrene 11.7 and phosphorous 0.5% as the incendiary mixture

e/ *Japanese 1kg Incendiary Bomb* consisted of a casing, 10" long and 3" in diameter, filled with red phosphorous and containing a burster (exploder) tube filled with Picric Acid. The bomb was exploded on landing by the PA. This ignited and scattered the phosphorous. Fragments of the bomb were thrown as far as 150 ft

f/ *Japanese 50kg Rubber-Pellets Bomb* consisted of a casing, 40.5" long and 4.5" in diameter, filled with many rubber pellets or balls impregnated with yellow phosphorous in carbon disulfide and containing a burster tube with high explosive, such as PA. On landing, the bomb was exploded by the burster and pellets were scattered to a distance of up to 150 ft. As soon as the CS₂ evaporated, the phosphorous ignited the rubber and this continued to burn for 5-7 minutes

g/ *Japanese 60kg Thermite Bomb* consisted of a casing, 40" long and 8" in diameter, containing three "electron" inserts filled with thermite and a burster charge of high explosive. On landing, the burster charge scattered the burning inserts as separate thermite units, thus increasing the radius of damage

h/ *Japanese 60kg Gelled-Oil Incendiary Bomb* consisted of a casing, 42" long and 9.5" in diameter, filled with gelled oil, such as kerosene and paraffin wax. Inside the filling there was a tube filled with thermite which had a quick match running through its center. On impact, the oil was ejected and was ignited by the thermite

i/ *Japanese 560 lb Bomb* consisted of a cylindrical, metallic casing loaded with pieces of 1-inch iron tubing, each 2-3/4" long. It was filled with a special thermite mixture. On landing, the burster charge fractured the casing, ignited the thermite and scattered the pieces of tubing to a distance of about 150 ft

j/ *Flame Thrower*—described separately in Vol 6 of Encycl

k/ *Miscellaneous Incendiary Ammunition.* Among these may be mentioned "incendiary cans and boxes" used during WWI as a means of defense against gas attacks. The heat generated by these devices produced air currents

which dispersed and deflected the gases

Various incendiary devices were designed for sabotage purposes, among them the ingenious device called "incendiary blue pencil," previously described

Special devices were attached to gasoline tanks of airplanes by means of which the airplane could be quickly destroyed in case it was forced down in enemy territory

1/ *Rocket Incendiary Projectiles*. During WWII several rocket incendiary projectiles were developed, among them may be cited:

German 32cm Rocket Projectile Incendiary carried a charge of 13 gals of flammable oil. It was used in anti-aircraft fire (Ref 9, p 55)

5-inch Incendiary Rocket, used at ranges of about 5,000 yds, was an effective weapon when fired from landing craft in amphibious operations. The rocket head was loaded with thermitic or oil incendiary mixtures

German R100BS Air-to-Air Rocket. The rocket weighed 100kg and was 210mm in dia and 1,800mm long. It was propelled by 25kg of conventional solid propellant which gave the missile a specific impulse of 4,200kg/sec with a burning time of 0.9 sec. The rocket attained a speed of 550-600 m/sec and had a range of about 2,000 m. The warhead weighed about 30kg and contained 460 thermitic-filled cylinders each weighing 55g. The pellets were given an initial velocity of 500m/sec in addition to the velocity of the rocket. The rockets were mounted under wings of a plane (Ref 14)

German Enzian Ground-to-Air Rocket. The rocket weighed 1,800kg which included the weight of four assisted take-off units weighing 80kg each. These units functioned for 5 sec and were then jettisoned. The missile had a length of 12 ft and a wing spread of 14 ft. The power supply had a duration of 73 sec which resulted in a vertical range of 16,000m and a horizontal range of 25,000m. The payload was either 300 or 500kg. These warheads consisted of a metal shell, 1 1/2mm thick containing cylindrical pellets of mild steel, 20mm in dia by 30mm long containing an incendiary core. This rocket appeared near the end of WWII and large-scale production was never attained before hostilities ended (Refs 14 & 15)

According to Fisher (Ref 9, p 55), the applicability of incendiary-filled rocket projec-

tiles to conditions of modern warfare is still somewhat uncertain despite the increasing importance of the rocket itself. At extreme ranges, the rocket cannot compete with the bomber in attacking incendiary targets because of the diffuse pattern of rocket impacts

Refs: 1) Daniel (1902), pp 151-4 2) Marshall, 1, (1917), pp 12-30; 2, (1917), p 568 & 3, (1932), 197 3) H.B. Faber, "Military Pyrotechnics," Govt Printing Ofc, Washington, DC, Vols 1 & 2, (1917) 4) A.B. Ray, IEC, 13, 641 & 714 (1921) 4a) A. Stettbacher, Nitrocellulose, 6, 202, 220 (1935); 9, 75, 100, 138 (1938); 13, 203, 224 (1943) 5) A.M. Prentiss, "Chemicals in War," McGraw-Hill, NY (1937) 5a) N.D. Cheronis, Chemical Warfare in the Middle Ages, JChem Education 14, 360-5 (1937) 6) C. Wachtell, Chemical Warfare, ChemCatCo, Brooklyn (1941) 6a) Anon, JChEducation, 20, 59-60 (1943), Recent Developments in Incendiaries 7) A. Stettbacher, Protar (Switzerland) (1944), pp 158-164 7a) Volta Torrey, New Incendiary Bombs Packed with Gelgas & Pyrogel, PopScience (May 1945), pp 100-106 8) Anon, Various Chemical Mixtures used in Chemical Warfare Service, Chemical Industries 57, 79 (July 1945) 8a) L.F. Fieser et al, "Napalm," IEC, 38, 768-73 (1946) 9) G.J. Fisher, "Incendiary Warfare," McGraw-Hill Co, NY (1946) 10) T.C. Ohart, Elements of Ammunition, J. Wiley & Sons, NY (1946) 10a) G.J.B. Fisher, "Incendiary Warfare," McGraw-Hill, NY (1946) 11) W.A. Noyes Jr, Ed, "Chemistry (Science in WWII)," Little, Brown & Co, Boston (1948) 12) A. Stettbacher, "Spreng-und Schiesstoffe," Rascher Verlag, Zurich (1948), pp 124-129 13) War Department Manuals on Incendiary Compounds & Devices

- a. TM3-215, Military Chemistry & Chemical Agents (1942), pp 149-150
- b. TM9-1980, Bombs for Aircraft (1942)
- c. TM3-325, Livens Projector MI (1942)
- d. TM3-330, Incendiary Bombs (1942)
- e. Flame Throwers (See below)

14) M. Cutler et al, "Preliminary Survey on Incendiary Pellet Warheads for Guided Missiles," Guided Missile Rept No 7 (Dec 1948), Tech Command, Army Chem Center, Md 14a) L. Finkelstein & A.E. Gaul, "Incendiaries," Vol 18, History of Research & Development of Chemical Warfare Service in World War II, The Chemical Corps Association, Washington, DC, Reinhold,

NY (1948) 15) F.I. Ordway & R.C. Wakefield, "International Missile & Spacecraft Guide," McGraw-Hill, NY (1960) 16) Anon, "Military Pyrotechnic Series, Part I, Theory & Application," AMCP 706-185 (1967), Chapter 5, Production of Heat 17) H. Ellern, "Military & Civilian Pyrotechnics," Chem Publ'g Co, NY (1968), Chapter 25, Fire Starting & Fire Setting

The following references on incendiary compositions, devices and uses are given in Chemical Abstracts:

G. Fox & G. Quayle, **13**, 1766 (1919), Igniter compound for "thermite": Na_2O_2 50, Mg powder 10, sulfur 5, KNO_3 5, carboric acid 30. It ignites on contact with H_2O

J. Buckingham, **13**, 1931 (1919), Incendiary projectiles containing yellow phosphorous with or without powdered aluminum

G. Vautin, **13**, 2284 (1919), Binding material for thermite, etc, consisting of Na and K silicates alone or mixed with borax or gelatinous $\text{Fe}(\text{OH})_3$

G. Webb, **13**, 2284 (1919), Incendiary mixtures suitable for projectiles: MgO 1.1p, Mg (wax-coated) 3.7p, $\text{Ba}(\text{NO}_3)_2$ 7, H_2O —sufficient to make the mixture set

G. Webb, **13**, 2284 (1919), Incendiary composition, such as MgO 3.45p, Mg (wax- or resin-coated) 3.7, $\text{Ba}(\text{NO}_3)_2$ 7. This mixture was dry-pressed. The alkaline earth serves as a retarder of combustion and, by varying the quantity of this ingredient, the rapidity of combustion can be fixed as desired within wide limits

A. Chanard, **14**, 350 & 1045 (1920), An incendiary material prep'd by incorporating a small amount of celluloid or NC in combustible substances such as resin dissolved in gasoline, heavy oil, tar, etc

W. T. Scheele, **15**, 3751 (1921), An incendiary mixture adopted for use in bombs and shells contains hexamethylenetetramine ($(\text{CH}_2)_6\text{N}_4$) 22.5 to 33.33 and Na_2O_2 77.5 to 66.66

Another mixture contains hexamethylenetetramine $(\text{CH}_2)_6\text{N}_4$ 25, Na_2O_2 50 and paraffin (or cylinder oil) 25

J. H. Hammond Jr, **17**, 472 (1923), Incendiary shell containing a thermite charge ignited by a mixture of BaO_2 and Al, fired by a concussion fuse

W. L. Clay & A. H. Hallowell, **17**, 473

(1924). Incendiary shell-structural features

A. Wolfson, **26**, 4720 (1932), Incendiary compound, which may be ignited by a spark produced by friction, is prep'd by mixing solid fuels, such as hex $(\text{CH}_2)_6\text{N}_4$ or metaldehyde, with readily flammable substances, such as NC, P or nitrophenols. The composition may be pressed into tablets

A. Stettbacher, **30**, 1563 (1936) and **32**, 8781 (1938). Review of chemical and mechanical incendiary devices

T. A. Craven, **31**, 1618 (1937), Incendiary projectile containing a charge prep'd by coating yellow phosphorous with a solution of a vegetable resin and a second coating of KClO_3 — Sb_2S_3 composition. The charge may be wrapped in cotton gauze impregnated with NaNO_3 with or without Mg composition to facilitate ignition

J. L. Nayler, **33**, 1941 (1939), Description of various incendiary bombs, particularly those containing oils, Mg and P, and ways of combating the fires

E. Fisher, **37**, 5241 (1943), Incendiary suitable for filling bombs and flares is prep'd by mixing thoroughly Mg dust with pulped paper in water and then filtering to produce a uniformly flat sheet or ribbon. After drying, the sheet is cut into pieces

W. R. Bluedorn & R. N. Nelson, **38**, 257 (1944), Incendiary bullet of special construction containing finely divided Ti as combustible material

Chemical Warfare Service, **38**, 1295 (1944), Brief history and description of modern incendiaries

C. W. van Hoogstraten, Chem Zentr **1941**, II, 3272 & CA **38**, 1880 (1944), Various types of incendiary bombs as well as means of combating the fires produced by them are described

W. C. Kabrich, **39**, 2649 (1945), Research in the Technical Division of Chemical Warfare Service in incendiaries, etc

W. K. Griesinger, **39**, 1284 and 4742 (1945), Canadian Pat 424914 (1945), Gelatinization of hydrocarbon distillates in order to prepare solidified fuels suitable as incendiaries, is achieved by mixing a hydrocarbon distillate with 0.5-10% by volume of an aqueous solution containing 10-40% by weight of petroleum sulfonate and

5-15% by weight of an alkali metal hydroxide. Petroleum sulfonate was derived from acid sludge separated from partly cracked gasoline-oil fractions which had been treated with H_2SO_4

Ford Motor Co, 40, 210 (1946). Incendiary material is prep'd by reducing MgO to Mg vapor and quenching the vapor in oil. This produces a thin slurry consisting of finely divided metallic Mg and oil. The slurry is allowed to settle, the oil is decanted and the thick slurry is filtered, leaving a thick, heavy mud

L. F. Fieser et al, 40, 5567 (1946) and Ind EngChem, 38, 768-73 (1946). "Napalm" (Detailed description of preparation and properties). Some other thickened fuels are described

A. Grobstein, 40, 5568 (1946). Incendiary with high penetrating power is prep'd by placing a capsule with Li nitride (Li_3N) into an incendiary bomb filled with thermite or other composition. On burning, the thermite produces sufficient heat to fuse the nitride into a mass, which then becomes a penetrating, hot, corrosive agent. Nitrides of Ce, K, Ca or La are also suitable

J. Billing & J. W. Fisher, 40, 6818 (1946). Incendiary projectiles are charged with a highly inflammable thickened fuel, prep'd by dissolving a quantity of metallic soap of a fatty acid containing 10 or more C atoms per mole, in a liquid hydrocarbon, preferably of the benzene series

G. J. B. Fisher, "Incendiary Warfare," McGraw-Hill, NY (1946)

H. Bond, Edit, "Fire and the Air War," National Fire Protection Association, Boston, Mass (1946)

H. R. Dittmar & D. E. Strain, USP 2443378 (1948) & CA 42, 6538 (1948). Incendiary gels containing a liquid hydrocarbon (such as gasoline, benzene, etc), 3% or less H_2O , some alkali (such as NH_3 , NaOH, $Ca(ON)_2$, etc), 1 to 10% of a salt of a hydrocarbon-sol, salt-forming, acrylic resin (such as polymers of alkyl acrylates, or alkyl acrylates contg small amts of free COOH groups), with or without salts of fatty acids (such as alkali metal stearates, palmitates, oleates, etc

H. H. Cooke & E. J. Holzclaw, USP 2445311 and 2445312 (1948) & CA 42, 7985-6 (1948). Incendiary mixtures consisting of flammable naphtha thickened to form a highly viscous mass by means of isoolefin polymers (such as

isobutylene polymer, mol wt 50,000 to 100,000). Small amounts of metal soaps may replace part of the polymer. Na, K, P and thermite mixtures may be included. The bomb contains a nose fuse, a black powder ignition charge, a thermite nose charge and a tube of thermite extending through the incendiary charge

D. P. O'Brien, USP 2451864 (1948) & CA 43, 1190 (1949). An explosive charge for incendiary bombs consists of Mg 32p, Ca_3P_2 2p and $KClO_4$ 1p

D. L. Woodberry et al, USP 2452091 (1948) & CA 43, 1190 (1949). Thermite mixtures can be improved by incorporating $Ba(NO_3)_2$, small amount of an oil and addnl Al beyond that required by the thermite; eg, Fe oxide scale 61.2, granular Al 19.2, grained Al 2.8, flaked Al 1.0, $Ba(NO_3)_2$ 14.6, S 0.9 and castor oil 0.3%. Particle sizes are of importance and are specified in detail

Wm. F. VanLoenen, USP 2530489 (1950) & CA 45, 2670 (1951). It is disclosed that a mixture of Mg, C and MgO obtained by the Hansgirg process (see below) protected by hydrocarbon oils and a metallic carbide, such as CaC_2 or a phosphide, form an incendiary composition which ignites in water or similar oxidizing liquid

Note: The USP 2530491; 2530492 and 2530493 describe various modifications of the above incendiary mixture

F. Hansgirg, USP 1884993 (1932) & CA 27, 942 (1933). A mixture of Mg, C and MgO prepared by a special process

L. Finkelstein, USP 2553568 (1951) & CA 45, 7354 (1951). Gelled gasoline for filling incendiary bombs is prep'd by dissolving in 88.75p gasoline, 3p stearic acid, keeping the temp at 26° . Isobutylmetacrylate 5p was next stirred into the mixture, then CaO was added and finally water 1.25p

M. E. Barker, USP 2558726 (1951) & CA 45, 9864 (1951) describes an incendiary device consisting of a mass of NC in the form of a disc, or leaf, with a hollow center filled with white P and sealed with a material such as gelled Na silicate. The disc is stored under water, or in atmosphere of saturated steam. When exposed to air the coating of silicate loses its water of gellation thus making it porous. Air then penetrates through the pores and causes

the P and then the NC to ignite. The thickness of silicate coating is so adjusted that a time delay of one to 3 hours is obtained after start of air exposure

J. A. Southern et al, USP 2570990 (1951) & CA 46, 1768 (1952). An easily combustible mixture suitable as fuel for incendiary bombs and grenades, flame throwers, etc. Consists of 7-14% volatile hydrocarbon fuel such as gasoline, and 93 to 86% of soap-type gelling agent, which is composed of Al oleate 50-75, Al stearate 25-50, to which is added about 1% of oxy-aromatic antioxidant compound

E. F. Bullene, ArmForcesChemJ 5 (4), 4 & CA 46, 1768 (1952) gives a review of gelled liquid hydrocarbon fuels

L. F. Fieser, USP 2606107 (1952) & CA 47, 1392 (1953). Incendiary gels prepared by mixing light hydrocarbon fuels with thickening such as Al soap of a soap-forming carboxylic or unsatd fatty acid or the Al salt of such acids as the other component; eg, gasoline 90, Al coconut soap 5, Al naphthenate 5%

M. D. Banus & J. J. McSharry, USP 2688575 (1954) & CA 48, 14210 (1954) specify that Ti powder for use in first-fire mixtures for incendiary bombs or shells should have a density of 0.4 to 1.7 and contain <0.425% hydrogen. Method of attaining these specs are described

L. E. Medlock, BritPat 742283 (1955). No CA listing found. These non-detonating, waterproof compositions consist of pulverulent oxidizing and reducing agents distributed uniformly through rubber or artificial rubber. Used for such purposes as fuses, igniter cords, and incendiary charges

H. Z. Cier & H. G. Schutze, USP 2794003 (1957) & CA 52, 1602 (1958). Incendiary gels, solid fuels, etc are prepd without external gelation agents when Na, K, Ca, Ba, Hg or Al derivs of oil-sol sulfonyl chlorides of satd paraffin or naphthenic hydrocarbons contg 6-16 C atoms are formed in the hydrocarbon to be gelled. Most of the gels contain 0.1-5.0% water, alkali and 1-5% metal. The hydrocarbon, SO₂, and Cl are exposed to light at 150°F for 15-360 min to give the sulfonyl chloride; addn of a basic Al soln or Al foil or powder with stirring forms the gel

C. Blake & Wm. S. Graff, USP 2819163

(1958) & CA 52, 5826 (1958). An incendiary for military purposes is described. It contains a core of Zr, Ti, and Pb which sparks intensely when abraded and an enveloping Fe case. A compn contg 35% Zr, 30% Ti and 35% Pb (Zr and Ti <15 μ, Pb -200 mesh) is mixed with a xylene-4% Perbunan (synthetic rubber) soln in the presence of 0.875 cc/g of powd metal. The particle size of the electrolytic Fe powder for the case is important in order that the porosity be controlled

C. B. Linn, USP 2881066 (1959) & CA 53, 14522 (1959) claims incendiary fuels consisting of gels formed by the condensation of 2 moles of an aromatic hydrocarbon with a ketose and gel-formation in benzene. The condensation of d-fructose with 2 moles of toluene, in an autoclave with HF catalyst, is given as an example

Raymond E. Schaad, USP 2891852 (1959) & CA 53, 17513 (1959). Materials useful as rocket fuels, semisolid or gelled fuels for bursting and tail-ejection-type bombs, and incendiary fuels for flame throwers and hand grenades are described. They are made by mixing 0.1-25% by wt of satd, unsatd, or aromatic nitrohydrocarbons or their mixts, such as nitro- or dinitromethane, -ethane, -propane, or -butane with divinylated ketoses or diaryl deoxyketitols prepd by reaction of C₃₋₈ ketose sugars with C₆₋₂₄ aromatic hydrocarbons. The latter include C₆H₆, toluene, naphthalene, anthracene and their alkylated derivs

J. Allovio, USP 2988438 (1961) & CA 55, 25257 (1961) claims a free-flowing, homogeneous incendiary mixture of granular material uniformly dispersed in a polymeric matrix

M. K. Shevchuk, "Zazhigatel'nyie Sredstva i Zashchita ot Nikh" (Incendiary Agents and Protection from Them), Voennoye Izdatel', Moskva (1961)—a book in Russian

P. Chereau, FrP 1318773 (1963) & CA 58, 13702 (1963), claims: rocket fuel or incendiary composed of a combustible metal, eg, Al, Mg, or Li or a liquid fuel such as kerosine, in fine grains or droplets encapsulated *in situ* by formation of a polymer skin. Thus, 0.18 of 2,4-tolylene diisocyanate is dissolved in 41.8g of paraffin oil. A portion (24.5g) of this mixt is added drop by drop to a stirred soln contg 2g of ethylene glycol in 250g water. Discrete spherical particles

are formed which are encapsulated by a skin of polyurethane. The particles are sepd by centrifugation

A. D. Coates & E. O. Baicy, USP 3120459 (1964) & CA **60**, 9094 (1964) claim the following: A storage-stable powder useful as an incendiary component, a solid rocket-fuel additive, or a metal heating powder is obtained by coating a powd material which contains excess O or liberates O on heating, such as KClO_4 (preferred), NaClO_4 , $\text{Ba}(\text{ClO}_4)_2$, KNO_2 , NaNO_2 , $\text{Ba}(\text{NO}_2)_2$, or NaClO_2 , under conditions which avoid decompn with 30-80% (of final coated product) of an exothermic metal, such as Al (preferred), Mg-Ti alloys, or certain Mg-Al alloys, by treating the O-contg material with metal vapor at 5×10^{-4} mm. Thus, 40-80 mesh KClO_4 , treated as described with Al vapor produced by heating Al ribbon or wire with Ti wire filaments, yields a product which, when initiated by flame or an elec impulse, reacts in a self-sustaining manner

F. N. Vannucci, USP 3126259 (1964) & CA **60**, 15676 (1964) claims a gelatinous incendiary material is made by mixing 1 part of a powdered material consisting of SiO_2 & MgO with an equal amt of water, adding 1 part of a hydrocarbon such as kerosine or gasoline, and separating. The resultant incendiary can be used to ignite coal or other fuels or in incendiary shells, bombs & flame-throwing devices. The powdered material can be made from serpentine rock

R. J. Laran, USP 3157464 (1964) & CA **62**, 2530 (1965) claims: HClO_4 & TiCl_4 were combined at -10° in a mole ratio of 8:1. The product was 97-8% $\text{Ti}(\text{ClO}_4)_4$. This compound exists in 3 cryst form; it can be stored without decomposition if air & H_2O are excluded & temp is kept low, eg, with dry ice. Also, freshly sublimed BeCl_2 & anhyd HClO_4 were allowed to react for several hrs at -15° . A white powder $\text{Be}(\text{ClO}_4)_2$, was obtained in 16% yield, excess acid having been removed *in vacuo*. Close temp control (-75 to 25°) & the absence of H_2O are essential to these reactions. The products are powerful oxidants, insensitive to shock & thermal decompn, useful as igniters for propellants & incendiaries. $\text{Ti}(\text{ClO}_4)_4$ explodes on contact with Et_2O & ignites on contact with HCONMe_2 or HCONH_2

P. Huber, BelgP 644290 (1964), claims polystyrene and/or polyisobutylene (3-5%) can be used as a gelling agent for inflammable hydrocarbons & other org liquids, such as CS_2 . Depending on the intended use, the compositions can be made shock-resistant, adhesive, and/or productive of thick black smoke

Review article: Chemical warfare: incendiaries. L. W. Greene, Kirk-Othmer Encycl Chem Technol, 2nd Ed, 4, 895 (1964) & CA **65**, 3661 (1966); including a survey of incendiary requirements, agents & bombs; 8 refs

J. E. Claiborne, USP 3250652 (1966) & CA **65**, 2057 (1966) claims: exothermic compositions useful as propellants, incendiaries & nuclear blast simulators, which upon addn of small amts of H_2O produce flame & hot expanding gases, are provided by intimate mixts of 10-100 mesh powdered metal (preferably at least half Zn), 10-250 mesh NH_4NO_3 , & 10-250 mesh NH_4Cl as a loose mass or as blocks, grains, or strands bound with an anhyd heat-softening gum or a thermoplastic resin or lacquer. Conventional diluents may be included to reduce reaction rate if desired. Thus, a mixt of 40-80 mesh Zn 30/powd NH_4Cl 20/powd NH_4NO_3 47/ & polyvinylchloride molding powder 3% was heated to the softening point & pressed into blocks which, when exposed 6 hrs to 85% relative humidity, spontaneously ignited, or, when immersed in 10% of their wt of H_2O yielded copious amts of H, NH_3 , Cl, N, & NO_2

H. W. Koch & F. Popperl, NASA Access No **N66-31925**, Rept No T-37/65 (1965) & CA **66**, 117, 557, (1967), discuss the chem compsn & incendiary characteristics of napalm & Phosphor-Mg compounds. Test arrangements for obtaining temp rates in various environments are described. Burning time is measured as a function of amount (sic) & spatial extension of the flame

A. Lachs, USP 3314836 (1967) & CA **66**, 117565 (1967) claims a military flame producing compsn containing colloidal yellow P in a flammable medium

M. Piccone, USP 3396060 (1968) & CA **69**, 78900 (1968) describes a long-burning, low d incendiary compsn containing Ti/Al-Mg alloy/oxidizer. The oxidizers used were Ba or Amm nitrates and K-perchlorate

J. R. E. Pleasant et al, USP 3414443 (1968) & CA **70**, 39441 (1969) claim an incendiary

compsn, which may be self-igniting for emergency kits & survival & distress fires. Metals or Metal hydrides are mixed with wax & a gelling agent

S. Schiff, USP 3416899 (1968) & CA 70, 39432 (1969). A napalm-type material is prep'd by hydrogenation of a hydrocarbon soln of a 3:1 butadiene-styrene block copolymer

P. G. Yur'ev, Zh. Vses Khim Obshchest 13 (6) 648 (1968) & CA 70, 69710 (1969), presents a general review of chemical incendiaries with particular emphasis on US Army weaponry; with 20 refs thru 1967

G. H. Custard, USP 3421439 (1969) & CA 70, 89345 (1969). An incendiary projectile is claimed which consists of a 20mm hollow body equipped with an impact-responsive primer, a booster charge & a main HE charge. The body of the projectile is of Ti or Zr which on ignition burns at temps of 2725-3325°C for up to 1 min

S. Samuel et al, USP 3441955 (1969) & CA 71, 23400 (1969). White P is mixed with hexamethylenetetramine to produce a smoke screen mixt which is also an incendiary. Al or Mg may be added to the mixt to raise flame temps or paper pulp, cellulose or high-melting hydrocarbons to produce longer burning times

J. Winkler, USP 3460922 (1969) & CA 71, 93351 (1969) claims a thixotropic-gelled flammable hydrocarbon compsn, containing powdered metals and/or AN, for use in flame-throwers, rocket fuel and napalm. The hydrocarbon gel is prep'd by an in situ cross-linking of a polyurethane

V. P. Wystrach et al, USP 3464869 (1969) & CA 71, 103746 (1969) claim a match-ignitable, tacky compsn for use in flares, signals & incendiaries. Example compsn is made by mixing Mg, AN, Napalm B with an acrylonitriline/acrylic acid/Me-methacrylate copolymer. It burns with a bright yellow flame

V. A. Lehtikoinen, USP 3498857 (1970) & CA 72, 113395 (1970) claims thermites and thermates (thermites + flake Al, S, hydrocarbon oil and/or oxidizers such as Ba(NO₃)₂, KMnO₄, etc) of improved ignitability due to inclusion of 2-50% of ferrocene-type compounds. Varying the proportion of ferrocene modifies the burning rate of the incendiary compsn

Incendiary Flash Tests for Small Arms Ammunition. The purpose of these tests is to investigate the ability of incendiary bullets to develop, upon impact, an incandescent flash, sufficiently hot and sustained to ignite explosive vapors, or to initiate combustion in other readily combustible materials. These tests also establish the relative size, position and persistence of the flash as compared with a standard chart. Tests are made under controlled conditions against a target of fixed design

Detailed description of these tests is given in Ordnance Proof Manual 7-19 (1945) (11 pps)

Incident Wave in Blast. See Vol 2, p B182-L & Fig in p B183 under Blast Effects Due to Reflected Shock Waves

Increments. See under Base Charge of a Propellant in Vol 2, p B24

Increment Appoint (Fr) or Zusatzladung (Ger). An additional quantity of propellant used when the charge contains some flash reducers in order not to impair the ballistics of a weapon
Ref: Davis (1943), 326

IncT or IT. Incendiary Tracer

Indazolone, 5,7 Dinitro.

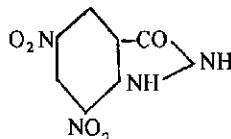

mw 304.3, N 18.4%, OB -58.0%; yellow prism (from w), decomposes 185-215° without melting; sl sol in water, benz & chl; moderately sol in boiling alc. Prep'd by reacting 3,5-dinitrobenzene with hydrazine hydrate. The *Na-salt*, Na₂C₇H₂N₄O₅, cryst, sol in w, alc or acet, explodes on heating. Reaction of the dinitro indazolone with HgCl₂ gives a crystalline needle-like product that is very unstable
Ref: Beil 24, 115 & (239)

Index of Damage. See under Damage Effects & Damage Potential of Air and Ground Blast Waves in Vol 3, pp D3-4

Index of Ignition. See Index of Inflammability under Physical Tests in Vol 1, p XVII

India Saltpeter. Same as Potassium Nitrate

Indicator Test Paper for Detecting Stability of Double-Base Propellants. Approx 60 commercially available dyes were investigated in experimental indicator test papers. Laboratory & surveillance tests indicated that 3 of these selected for further evaluation were less sensitive to double-base proplnt degradation products than N/10 Methyl Violet paper. The order of sensitivity was as follows: N/10 Methyl Violet, 0.1% Ethyl Violet, 0.1% Trypan Red & 0.1% Benzoazurine. On exposure to four different types of partially degraded but still serviceable double-base proplnts for a period of 1 yr, strips of each of these experimental indicator papers remained either unchanged or became only slightly faded. The N/10 Methyl Violet paper became totally bleached within 3 months

However, strips of the experimental indicator papers, when exposed to oxides of N fumes generated in the lab and to double-base proplnt fumes generated at an elevated temp, became either entirely bleached or totally faded
 Refs: 1) S. Helf, PATR 1782 (Oct 1950) 2) P. Rochlin, PATR 2242 (Sept 1952) (Concluded that the 3 experimental test papers appeared to be superior to N/10 Methyl Violet paper for detecting instability in stored proplnts)

Indice Nitrométrique or Indice de l'Action Stabilisatrice is a value introduced by M. Giua & G. Guastalla and reported in AttiAccadScienze Torino 60, 73 (1925) & Chim & Ind 29, 63T (1933)

It was shown by the above authors that nitrogen content of nitric esters such as NG or NC cannot be determined by the nitrometer method, if stabilizers such as centralite are present, because centralite absorbs some nitrogen oxides thus giving a low result for N. The difference between the nitrometer N content of NG in absence of a stabilizer and N content of NG in presence of a stabilizer may be taken as an index of stabilizing action of the stabilizer; the bigger the difference, the better the stabilizer. This difference is called indice nitrométrique

Indigo, 5,5'-Dinitro.

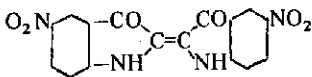

mw 352.2, N 15.9%, OB -136.8%; deep-red crystals (from NB), sol in hot NB or phenol, insol in alc or eth. Prepd by mixed acid nitration of indigo, or reaction of Diacetyl-6-nitro-indoxyl (in air) with hot sulfuric acid. On heating it puffs off giving off red-violet vapors

Indigo, 6,6'-Dinitro. A dark-red powder, insol in w, sl sol in alc, eth or benz, sol in hot aniline. Prepd by heating 2,4-Dinitrophenyllactic acid, methylketone with Na₂CO₃. Sublimes on glass surfaces, puffs off on platinum surfaces
 Ref: Beil 24, 429 (382) & [245]

Indole-carbonic acid, 5,7-Dinitro (called 5,7-Trinitroindol carbonsäure or Dinitrostrychol in Ger).

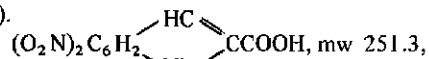

N 16.7%, OB -91.7%; pale yellow cryst (from alc), darkens 250°, mp ~284° (with decomp); insol in most solvs except hot alc. Prepd by heating 5,7-Dinitro-indole-dicarboxylic acid in water. Its Et ester-Trinitro derivative melts at 202-205° and is stable (Ref 2)

Refs: 1) Beil 22, [49] 2) CA 29, 158 (1935) 2) F.C. Mathier & R. Robinson; JChemSoc 1934, 1415 & CA 29, 158 (1935)

Indole-carbonic acid, 5,7,x-Trinitro (called 5,7-Trinitroindol carbonsäure or Trinitrostrychol in Ger).

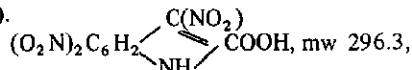

N-18.9%, OB -63.0%; leaflets (from water), mp 218-220° (with decomp); sol in hot water or alc, sl sol in benz or eth. Prepd by nitrating 5,7-Dinitro-indole-dicarboxylic acid with fuming nitric acid. Puffs off on heating

Ref: Beil 22, [49]

Induced Ground Waves. See Vol 3, p D4-L under Damage Potential of Air and Ground Blast Waves

Induction Period. See under Delay to Ignition in Vol 3, p D53-R; also under Hot Spots in this Vol

Indurite. The first successful American smokeless proplnt invented by C. E. Munroe in about 1891 and patented in 1893 (USP 489684). It

was prepd by washing ordinary Guncotton (GC) with methanol, in order to remove the lower NC's, and then gelatinizing (colloiding) it with NB (nitrobenzene) in the proportion, GC 40 and NB 60. It was made with or without oxidizing salts, such as KNO_3 etc. The resulting gelatinous mass was rolled into sheets of desired thickness and cut into squares or strips which were hardened ("indurated") by the action of hot water or steam. This treatment also distilled off most of the NB and left a hard and tough colloided substance

When tested, it gave satisfactory results in guns ranging from the one-pounder to the 6" gun. The reason why it was not adopted by ordnance, was that at a slightly later date Lt Bernadou introduced in USA **pyro powder**, which was the same as Mendeleev's "pyro-collodion" powder, but with slightly higher nitrogen content
Refs: 1) C. E. Monroe, *JACS*, **18**, 817-46 (1896)
 2) Davis (1943), 296

Industrial (or Commercial) Explosives, also called **Civil (or Civilian) Explosives**. See Agriculture and Forestry Use of Explosives in Vol 1, p A112-R; Blasting Explosives in Vol 2, p B202-L; Commercial or Industrial Explosives in Vol 3, p C434-R; and Dynamites in Vol 5, p D1584-L

Industrial Disaster Control is briefly discussed in the "Dangerous Properties of Hazardous Materials" by N. Irving Sax, Reinhold, NY (1957), pp 166-169

Industrial Fire Protection. We quote from Section 6 of "Dangerous Properties of Industrial Materials," 3rd Edit, by N. Irving Sax, Van Nostrand, Reinhold, NY (1968)

"**WHAT IS FIRE?** Fire, combustion, or burning requires three things: (1) a *fuel* (any oxidizable material), (2) *oxygen* (usually air), and (3) a certain *temperature* (heat). Fire is the chemical union of oxygen with fuel, accompanied by evolution of thermal energy, indicated by incandescence or flame. If any one of these three constituents is not present in the proper proportions or degree, no fire will occur. If a fire exists and even one of them is sufficiently altered, the fire will go out. Therefore, in its simplest form, all fire

control or extinguishment reduces to a manipulation of these three essential constituents

Classification of Fires

Class A Fires. These are fires in *ordinary combustible materials* where the quenching and cooling effects of quantities of water or solutions containing large percentages of water are of first importance. Ordinary combustible materials tend to produce glowing embers after burning, and these must be quenched to prevent rekindling

Class B Fires. These are fires in *flammable liquids* (oils, gasoline, solvents, etc.), where a blanketing or smothering effect is essential to put the fire out. This effect keeps oxygen away from the fuel, and can be obtained with carbon dioxide, dry chemical (essentially sodium bicarbonate), foam, or a vaporizing-liquid type of extinguishing agent. Water is most effective when used as a fine spray or mist

Class C Fires. These are fires in *electrical equipment*, where the use of a nonconducting extinguishing agent is essential. Water spray, carbon dioxide, dry chemical, or vaporizing liquid is satisfactory

Metal and Gas Fires. Such fires have not yet been classified. These require special agents and techniques. For a discussion of extinguishing agents and techniques for these classes of fire see p 206

Definition of Terms

The meanings of fire control terms as used in this book are as follows:

Flash Point (flash p). This is the lowest temperature at which a liquid will give off enough flammable vapor at or near its surface such that in intimate mixture with air and a spark or flame it ignites. The flash point of liquids is usually determined by the Standard Method of Test for Flash Point with the Tag Closed Cup Tester (ASTM D56-52, available from the American Society for Testing Materials, 1916 Race St, Philadelphia, Pa). This method is also the standard of the American Standards Association (ASA Z11.24-1952, available from the American Standards Association, 70 East 45th St, New York, NY). The Interstate Commerce Commission uses the Tag Open Cup (TOC) Tester giving results 5-10°F higher (less flammable). Other methods frequently used are

Cleveland Open Cup (COC) and Pensky-Martens (PM). The closed cup flash point value is usually several degrees lower (more flammable) than the open cup, as the test in the former case is made on a saturated vapor-air mixture, whereas in the latter case the vapor has free access to air and thus is slightly less concentrated. For this reason, open cup values more nearly simulate actual conditions (see below).

Fire Point (fire pt). This is the lowest temperature at which a mixture of air and vapor continue to burn in an open container when ignited. It is usually above the flash point. Where the flash point is available, only it is given; if it is not, the fire point may be given. It is at least as significant as the flash point as an indication of the fire hazard of a material.

Autoignition Temperature (autoign temp). This is the temperature at which a material (solid, liquid, or gas) will self-ignite and sustain combustion in the absence of a spark or flame (ASTM Designation D286-36). This value is influenced by the size, shape and material of the heated surface, the rate of heating (in the case of a solid), and other factors.

Vapor Density (vap d). This value expresses the ratio of the density of a vapor to the density of air. The vapors of most flammable liquids are heavier than air, thus they can readily flow into low areas, excavations and similar localities. Hence, ventilating outlets in a plant should be located near ground level. For combustible gases and vapors which are lighter than air, ventilating outlets should be near the ceiling.

Melting Point (mp). This is the temperature at which the solid and liquid forms of a substance exist in equilibrium. This value indicates at what temperature flammable materials that are solid at room temperature may become flammable liquids.

Boiling Point (bp). This is the temperature at which a continuous flow of vapor bubbles occurs in a liquid being heated in an open container. The boiling point may be taken as an indication of the volatility of a material. Thus, in the case of a flammable liquid, boiling point can be a direct measure of the hazard involved in its use.

Formula. In the event of a lack of information

regarding a material, its formula can give a clue to its fire hazard. For instance, all materials composed solely of carbon and hydrogen are combustible and in some degree flammable. If they are liquids with a low boiling point they can be assumed to be fire hazards.

Underwriter's Laboratories Classification (ulc). This is a standard classification for grading the relative fire hazard of flammable liquids against the following standards:

Ether class	100
Gasoline class	90-100
Ethyl alcohol class	60-70
Kerosene class	30-40
Paraffin oil class	10-20

Where this value is known it is an excellent measure of the relative hazard of a flammable liquid. Unfortunately, it is available in only a few instances.

Susceptibility to Spontaneous Heating. Many materials combine with atmospheric oxygen at ordinary temperatures and liberate heat. If the heat is evolved faster than it is dissipated due to poor housekeeping, a fire can start, particularly in the presence of easily ignited waste, etc. ["Factory Mutual Modified Mackey Method," Industrial and Engineering Chemistry (March 1927)]

Explosive Range or Flammability Limits.

These values expressed in percent by volume of fuel vapor in air are the ranges of concentration over which a particular vapor or gas mixture with air will burn when ignited. If a mixture within its explosive range of concentrations is ignited, flame propagation will occur. This range will be indicated by *l*el for lower explosive limit or *u*el for upper explosive limit. The values given, unless otherwise indicated, are for normal conditions of temperature and pressure.

FIRE PROTECTION

The two main aspects of fire protection are *prevention* and *loss limitation*.

Prevention

Fire prevention is an inseparable requirement of fire safety. Since, in order for a fire to start, all three necessary constituents—fuel, oxygen, heat—must be represented, effective fire prevention simply boils down to manipulation of these constituents to the extent that a fire cannot start. For instance, where a flammable material such as acetone is used out in an open

work shop, two of the three needed constituents are immediately present, i.e. the fuel and a supply of oxygen. Now the only thing lacking to start a fire is heat. Thus by referring to acetone in Section 12 it is found that the flash point is 14°F, which means that at any temperature above 14°F, acetone can evolve enough vapor to form a flammable mixture with air which will catch fire if exposed to a spark, flame or other source of ignition. Thus, strictly from the standpoint of fire prevention in an installation using acetone, the following avenues are open:

(1) The working (ambient) temperature must be kept below 14°F, or

(2) The supply of atmospheric oxygen must be cut off, or

(3) Sources of ignition, such as flames, glowing cigars and cigarettes, sparks, etc must be eliminated from the area, or

(4) The area must be ventilated so that even though the acetone gives off enough vapor to form a flammable mixture with air, the vapor will be drawn out of the area by means of fume exhaust equipment as rapidly as it is evolved, thus preventing the build-up of dangerous concentrations of vapors

Naturally, since conditions (1) and (2) above are relatively difficult to attain on an industrial scale, conditions (3) and (4) are the ones most likely to be used

Furthermore, although total removal of any one of the necessary conditions for a fire will absolutely prevent its occurrence, such stringent restrictions on industrial operations are seldom economically feasible. Industrial materials are, however, studied with a view to ascertaining just how much leeway there is, so that a compromise between absolute fire prevention and economy of operation may be reached. It is for this reason that, while we know how to prevent fires, they still do start, and why *loss limitation* is such an important part of industrial fire protection

Below is some discussion of the three essentials of fire.

Oxygen. Although under certain unusual circumstances it is possible to produce combustion-like chemical reactions with materials such as chlorine or sulfur, it is safe to say that nearly all combustion requires the presence of

oxygen. Also the higher the concentration of oxygen in an atmosphere, the more rapidly will burning proceed. Industrially it is difficult to manipulate the oxygen concentration in a working area, particularly since a concentration of oxygen far enough below normal to keep fires from starting would also be too low to support human life.

When industry has found it necessary to work with materials so sensitive to oxygen that they would catch fire at ordinary temperatures merely upon being exposed to air, it has found it possible to isolate such materials from air, either in a vacuum chamber or in a chamber filled with an inert atmosphere, such as argon, helium, or nitrogen. In Section 12 the materials which require such isolation are so noted

Heat. As a necessary component of fire, this is often manipulated to render an industrial set-up safe from fire. The most difficult aspect of controlling the heat component of a fire is the easily overlooked fact that to *start* a fire it is often necessary to heat to a sufficient degree only a *very small quantity of fuel and oxygen mixture*. Then, since fires are by definition exothermic, the very small fire started by a tiny heat source supplies to its surroundings more heat than it absorbs, thus enabling it to ignite more fuel and oxygen mixture, and so on, until very quickly there is more heat available than is needed to propagate a large fire. The heat may be provided by various sources of ignition, such as high environmental (ambient) temperatures, hot surfaces, mechanical friction, sparks, or open flame

Fuel. The third aspect of fire prevention will be discussed in detail in the following section

Sources of Ignition

The following are the chief sources of ignition and suggestions for reducing the hazard due to them:

(1) **Open Flames.** At or near a flammable-liquid installation it is necessary to check for such sources as burners, matches, lamps, welding torches, lighting torches, lanterns, small furnaces, and the possibility of broken gas or oil lines becoming flaming torches. Ample isolation may often be obtained by means of partitions.

In this respect the partition should be substantial enough to contain the fire while the sprinklers or other fire-fighting apparatus put it out. Fire-

resistant construction (brick or concrete walls) is generally recommended

It is important to confine the flammable liquid while it is in use. Safety cans should be used for transporting small quantities of flammable liquids about a working area, as well as for storage at a bench. Wherever possible, closed systems should be used to prevent the spread of fumes, etc. In the event of a fire, it is imperative to prevent spreading of the fire. Hence all tanks should have trapped overflow drains leading to a safe place. Dikes must be used to contain the overflow of burning liquid; otherwise fires could easily spread over large areas, trapping personnel and causing great damage. The principle behind this form of protection is to contain the fire at all costs. Installations of flammable liquids in upper stories should be made only in such a fashion that burning liquid will be prevented from flowing down stairwells, pipe openings, cracks in walls, etc, by means of waterproof floors, dikes, overflow pipes, etc

(2) Electrical Sources (electric power supply and generating equipment, heating equipment, and lighting equipment). The following precautions for good maintenance are suggested. A complete listing cannot be given here. The provisions of the National Electrical Code are the recognized standard and these should be carefully observed in installing electrical equipment in hazardous locations

(a) Use special wiring and conduit

(b) Use explosion-proof motors, particularly if located at ground level or in pits or low places

(c) Use only specially engineered heating units, keeping in mind the autoignition temperature of the material in use (hot water or steam heating units are much to be preferred)

(d) Controls for motors, thermal cut-outs, switches, relays, transformer contactors, etc which are liable to spark or heat up should not be installed in flammable liquid storage areas. Use only explosion-proof, push-button control switches within such an area

(e) In dangerous atmospheres and for storage, only vapor-tight globes with electric lamps may be used. In well-ventilated areas, ordinary lamps will do. Fixed lamp installations are to be preferred to extension cords. Also, approved safety flashlights are preferred to portable lamps

(f) Do not install fuses or circuit breakers in hazardous locations except in explosion-proof cases

(g) Motor frames, control boxes, conduits, etc should all be grounded in accordance with the general requirements for installation of electric power as outlined in the National Electrical Code

(3) Overheating (excessive temperatures at points requiring heat). Such processes should be kept out of combustible buildings and closely supervised. The use of automatic temperature controls and high temperature limit switches is recommended, although supervision is still important

(4) Hot Surfaces. The incomplete immersion of hot metal in quenching baths, the contact of flammable vapors and hot combustion chambers, hot dryers, ovens, boilers, ducts and steam lines all are frequent causes of flammable vapor fires. Care should be taken that material whose auto-ignition point is lower than the temperature sometimes reached by operating equipment be kept at a safe distance from such equipment. This equipment should be carefully supervised and maintained to prevent accidental overheating, etc

(5) Spontaneous Ignition. Many fires are caused by spontaneous heating of materials, accelerated by external heat from processes such as dryers, ovens, ducts, impregnating or steam lines adjacent to piles of waste materials. Sometimes the accumulated heat in a closed, unventilated warehouse will be sufficient to accelerate oxidation to the point of an actual fire. Wherever flammable liquids are handled, particularly those which are known to be liable to spontaneous heating, it is important to pay particular attention to housekeeping and ventilation. Fires are almost sure to follow neglect of these matters. All equipment and buildings should be kept free of deposits and accumulations of wiping rags, waste materials, oil mops, etc

(6) Sparks, etc. Sparks from mechanical tools and equipment, hot ashes from smoking, unprotected extension lights, boilers and furnaces, backfire from gasoline engines, are all potential causes of fire. Smoking should be prohibited in areas where flammable liquids are stored or are used in the open. All equipment in such areas should be maintained in first class condition. Wherever possible, spark-proof or non-sparking tools and materials should be used

(7) **Static Electricity.** This is due to electrical impulses generated on the surface of a material by friction, such as calendaring, printing, and the like. Many fires are caused in the rubber and paper industries by this means. Most of these occur during the months when humidity is relatively low, and artificial heat is used. Maintaining a relative humidity of from 40–50 percent in rooms where flammable liquids are used will greatly reduce the chance of static sparks. Electrical grounding, static discharge devices, etc should be mandatory, and all flammable liquid tanks, piping and equipment should be so interconnected and grounded that the chances for static sparks are minimized. In all this type of equipment, belts should be eliminated and direct or chain drives used wherever possible. If belt drives must be used, the belt speed should be kept below 150 ft/min, or a special belt dressing should be used which will reduce the possibility of the formation of a static spark

(8) **Friction.** Many fires are caused by mechanical friction, ie from fan impellers rubbing on casings, poorly lubricated fan bearings, grinding processes and machining, etc. Fans and other equipment should be frequently inspected and maintained in the best possible condition. Other processes known to generate a good deal of heat due to friction should be well separated from locations where flammable liquids are stored or used

It is vitally necessary that a complete program for the handling, transfer and use of flammable liquids be set up and maintained. This program should start when the process is initially under construction. Where flammable liquids are called for in the original write-up of a process, the first question is to determine whether the flammable material can be replaced by a non-flammable one. If the question of cost arises it should be remembered that to the possibly low cost of the flammable liquid should be added the cost of special protection needed to use it safely as well as its effect upon the insurance rate. It may well be that in the final analysis, the cost of a flammable material is not as favorable as it seemed at first. However, there are many flammable materials in constant use for which there are no substitutes, but even they can be safely handled if proper precautions are taken

(9) **Fuel.** Combustion takes place most read-

ily between oxygen and a fuel in its vapor or other finely divided state. Solids are most easily ignited when reduced to powders or vaporized by the application of heat, but except in a few cases the temperatures required for the vaporization of solids are well above normal ambient temperatures

Liquids present a different case. Some liquids will give off dangerous quantities of flammable vapors well below normal room temperature (the vapor pressure of a liquid is a measure of this effect); others do so at points only slightly above room temperature, and still others at much higher temperatures. It is apparent that the temperature at which a liquid evolves vapors which can form flammable mixtures with air is a measure of its hazard potential. This is indicated by the flash point

So indicative of fire hazard is the flash point of a liquid that the Interstate Commerce Commission rates any liquid whose flash point is 80°F or below as a *high* fire hazard, the theory being that 80°F represents the upper limit of normal or “room” temperatures; any liquid which will flash at or below this point is dangerous. A flash point of from 80–350°F indicates a *moderate* fire hazard; above 350°F the fire hazard is considered slight. The national Fire Protection Association rates as a *high* hazard a liquid whose flash point is less than 20°F; *moderate* from 20–70°F, and *slight* from 70–200°F. Only liquids having a flash point less than 200°F are generally called flammable by the National Fire Protection Association

In this book we use the ICC classification for liquids of flash point at 80°F or less as being *dangerous* fire hazards; we use the range from about 80–225°F to indicate *moderate* fire hazard; flash points in excess of about 225°F are rated as *slightly* hazardous. It should be understood, however, that practically all organic materials will burn if exposed to sufficiently high temperatures. The ratings given above are merely as indication of the risk involved in handling or storing them

It is important to isolate a potential fire hazard. Thus it is necessary to use closed and vented tanks to hold flammable liquids. In this way the possibilities of igniting the tank of liquid are greatly reduced, as is the chance of materials at a distance from such a tank becoming involved in

fires. It is also important that flammable materials be housed in fire-resistant structures because burning liquids can generate great heat and often set fire to the buildings in which they are burning.

A vital point in flammable liquids safety is the prevention of the accumulation of explosive concentrations of vapors in closed off areas. Wherever either moderately or highly flammable liquids are used or stored, ventilation is a very important consideration.

The amount needed, whether natural or mechanical (fans and blowers) depends upon the materials and the conditions involved. No dependence should be placed upon the odor of the material as a warning, because some flammable vapors are heavy and tend to settle and because smell is deceptive. The safe procedure is continual testing with an explosion or flammable vapor indicator.

Besides flammable liquid fires, the results of which can be *somewhat* mitigated by effective loss limitation techniques, there are two more types of disaster, protection from which is nearly entirely dependent upon prevention.

(10) Dust Explosions. Practically any combustible, when in the form of dust and mixed with air in the proper proportion, will burn so rapidly as to cause a severe explosion if ignited by heat, a spark or flame. Ignorance of this fact has led to many serious disasters. Grain, flour, coal dust, and metal powders all constitute hazards in this regard. Explosions have been known to occur in plants handling fertilizers, wood dust, powdered milk, soap powder, paper dust, cocoa, spices, cork, sulfur, hard rubber dust, leather dust, and many other products. For the prevention of dust explosions good housekeeping is of the utmost importance. All equipment must be dust-tight and kept so. Explosion vents should lead outdoors to a safe location, and the vent ducts themselves should be strong enough to withstand the force of the explosion. Vacuum cleaning is superior to sweeping. The use of compressed air to blow dust off equipment and thus create dust clouds should be *forbidden!*

Ledges, exposed piping, beams, etc in the ceilings should be kept free from accumulation of dust. Where a dusty operation is to be installed in a location where there is piping and projections overhead, it is often erroneously con-

sidered satisfactory to install a smooth ceiling below the piping and other projections. This does not eliminate the hazard and may intensify it; unless the ceiling is extremely well designed and installed, dust will penetrate it and settle not only on the piping but on the upper side of the ceiling itself. Then a shock may be sufficient to fill the entire false space with a combustible dust cloud which a spark may set off. If piping cannot be relocated or eliminated, it would be better to leave it exposed and provide for a regular cleaning program.

It was for reasons such as the above that a starch dust plant recently constructed in the southwest, where weather conditions are moderate the year round, has been built entirely of open construction so that there is no confinement of the force of any explosion and the constant flow of air through the plant provides little opportunity for dust layers to build up.

As in the case of flammable liquid fires and explosions, the control of dust explosions is based upon prevention of ignition and secondarily limitation of damage in the event ignition does occur.

To prevent ignition, open flames, smoking, and cutting or welding are prohibited until the area is made dust free. Electrical wiring should be of the type suitable for a dusty atmosphere and static electricity, too, must be eliminated. Highly dangerous materials of this sort are handled most satisfactorily in enclosed systems in which suitable inert gases are introduced into the system to replace the air normally present. This precaution is particularly applicable to the field of powder metallurgy. The kind of inert gas used must be chosen on the basis of its suitability for the operation in question.

(11) Salt-bath Explosions. The third type of disaster in which after-the-fact protection is much less important than prevention is the molten salt-bath explosion. There have been serious disasters involving such baths, because personnel involved on both the management and the operating level failed to appreciate the potential hazards of the situation. Due to mechanical failure or human failure, or a combination of both, molten salt baths have been allowed to explode. The hazards of molten salt baths may be summarized as follows:

(1) Violent generation of steam due to water

introduced as "carry-over" on a piece of work from a preliminary cleansing or quenching bath, condensation on overhead service piping, leaky roofs and operation of automatic sprinklers, also contact with liquid foods placed on ledges near the baths for "warming-up" by workmen

(2) Sudden and explosive expansion of air occluded in blow-holes of castings and that trapped in tubes, closed piping, or hollow metal work when immersed in molten baths without pre-warming

(3) Violent and uncontrollable chemical reactions between nitrate baths and carbonaceous materials such as oils, soot, graphite, and cyanide carry-over from adjacent carburizing baths

(4) Vigorous and explosive reaction between overheated nitrate baths and aluminum alloys

(5) Explosive reaction between normally heated nitrate baths and carelessly introduced magnesium alloys

(6) Thermit-like reaction between aluminum alloy articles lost in bath and the iron oxide sludge blanketing and insulating the bottom of bath container

(7) Structural failure of bath container while in operation under conditions tending to lower the normal durability; reaction between metal of bath container and nitrate due to localized overheating

(8) Failure of temperature controls, with consequent overheating of nitrate bath

(9) Storage and handling of bulk supply of sodium nitrate, and careless disposal and storage of waste nitrate without regard to active properties of the salt

(10) Accidental or uninstructed setting of temperature control above safe operating limits

The precautions for safe operation of molten salt baths are summarized as follows:

(a) Guard against the introduction of any extraneous matter

(b) Protect completely from overheating by automatic control and temperature readings taken at regular intervals

(c) Isolate the operation as far as practicable

(d) Instruct all personnel thoroughly and completely in regular and emergency procedures

From the foregoing it can be clearly seen that the handling of flammable liquids, flammable dust or molten salt baths are the three chief

operations in which prevention is the most important phase of fire protection. In each of these cases whatever action is taken after the act and whatever physical protection is provided can only furnish some degree of mitigation of loss and it is often insufficient to prevent a large scale disaster

Loss Limitation

The other aspect of a realistic fire protection program is limitation of loss due to a fire which includes a provision for the *prompt discovery* and equally *prompt extinguishment* of the fire. It is certain that everyone has at one time or another wondered why a particularly destructive fire was allowed to happen, when supposedly a great deal of effort is constantly being devoted to the prevention of such fires

It may be that too often the prevention aspect of fire protection has been the total or nearly total effort at protection, with the result that when even a small fire starts it has a good chance to become a calamity. However, even the utmost vigilance would have been of no avail in guarding against some of the fires which are on record, and once the fire has started its cause is immaterial. The cause of the *loss* is much more important, and the facts which determine *that* are the physical conditions and those measures which have or have not been taken to limit the extension of the fire

One of the means of preventing the extension of fire is to segregate hazardous processes and storage into separate buildings. But even where hazardous processes are not involved, the concentration of too much value in one fire area must be guarded against. This is best accomplished by the erection of separate buildings, adequately spaced, which in turn presents problems of maintenance and operation. Suppose a major plant has an operation involving flammable liquids. Such processes as spray painting or dipping use tremendous quantities of flammable solvent; extraction processes and the manufacture of products of which flammable solvents are major constituents are typical examples of processes which require subdivision. The flammable liquid operations and all its appurtenances must be physically separated from the rest of the plant for maximum safety. Care should be taken that the separate buildings are no larger than production efficiency demands; in

other words, only as much should be put under one roof as is necessary to be in one building. Where space or production requirements preclude separate buildings, the area in which flammable liquids are handled must be physically separated from the rest of the plant by approved fire walls or, where these are not practicable, by water-curtain type sprinklers

Subdivision of one large risk into smaller fire areas may also be accomplished by means of fire walls which stop the spread of fire from one area to another. To accomplish this, the wall must be carried through the roof and either go through the side walls for a distance of at least 36 inches or turn back on both ends for a distance of several feet to provide a barrier around which the fire cannot travel

Many otherwise sound fire walls have failed because holes were made in the walls to permit the passage of pipes, conduit, etc, and then never properly closed. Every hole in a fire wall must be sealed at the time such work is being done. The weakest point in a fire wall is the fire door provided to permit access from one section to another. At any given time a high percentage of such doors are found upon inspection to be useless as fire barriers: They must be test operated regularly. The chief deficiencies are missing fusible links, damage to the doors by materials handling equipment, which damage would prevent their operation, or blocking by material left in the doorway so that the door cannot close

Proper maintenance includes regular inspection, physical guarding to prevent damage, the painting of "keep clear" lines on the floor, and a constant program of education. Wherever practicable, such doors should be closed at night to insure that they will be closed in the event of fire. Where the use or occupancy of the building has changed and fire doors are not needed any longer, the openings should be bricked up to the same thickness as the original walls. Even a pair of fire doors, one on each side of the opening, is less resistant to the passage of fire than the fire wall in which they are installed. In normal operation, because of the aisle space leading to the opening, the heat on the door should be less than elsewhere in the building. If the doors are closed and contents are piled against the doors, fire may be transmitted from

one side of the wall to the other. In all cases, the doors provided should be of the type approved for the opening in the wall. In many cases, doors approved for use only on vertical enclosures such as stairways are installed in fire walls and will not serve their intended purpose in the event of fire. If openings are necessary in fire walls for the passage of conveyors and no type of door installation is practical, then the openings should be specially protected by hooded automatic sprinkler heads directly over the opening on each side of the wall. A fire wall should be thought of as a dam which any small leak can cause to fail

The spread of fire from floor to floor in a building is prevented by the proper enclosure of vertical openings such as stairways, elevators, shafts, and process openings through the floor. The question of stairways deserves particular comment because in so many cases, self-closing stairway doors are found to be wedged open to permit easy passage from floor to floor. Such examples of poor management entirely negate the cost of closing the stairway off by providing the doors in the first place

One of the primary reasons for enclosing stairways is to permit the passage without injury of personnel from upper floors to the street level past the floor which is on fire. If the stairway doors are wedged open this may be impossible. The stairways can immediately become choked with hot air, smoke and gases from the stairwell

Provision of fusible link arrangements to close such doors is not very satisfactory because fumes and smoke will pass through without operating the link. In at least one laboratory the problem of stairway doors being wedged open versus the desirability of having them closed in a hurry has been solved by providing for electric latches. These latches hold all the doors open, but connected to the fire alarm system is a relay which causes all the electric locks to release when a fire alarm is sounded, thus closing the doors

A further loss-limiting device which is useful where flammable dusts and vapors are used is the explosion vent. It is important to install explosion vents in areas where flammable liquids or dusts are used because of the possibility of great damage due to explosive ignition of such mixtures and air. Therefore, on a practical basis,

properly designed explosion vents are a suitable safeguard, as they reduce the chances of destruction indoors by allowing the force of the explosion to be transmitted outdoors

In order to fully relieve the pressures produced by explosions in vapor and air mixtures, a vent area as large as 1 square foot for every 10 cubic feet of room volume would be necessary. However, it is unlikely that more than a fraction of the total volume of a room will at any time be within the explosive range. Therefore for a small room with a floor area of about 200 square feet, the venting area should be at least 1 square foot for each 30 cubic feet of room volume. For larger areas, this proportion may not be obtainable, but in no case should the vent area be less than 1 square foot for each 50 cubic feet of volume

Approved explosion venting windows are available. Also, sky-lights, roof hatches, or light windows hinged at the top and carefully installed to swing outward under even slight pressure can be useful. Under some conditions, doors equipped with releasing latches may be utilized as vents

Furthermore, where the conservation of heat in a plant is important, and the walls of the building are otherwise of strong construction, a section of exterior wall may be built of light wood, or hollow tile or some other material which is relatively weak compared to the rest of the building so that in case of an explosion, these sections will give first

It is important that snow or ice be kept from collecting on explosion vents so that they can operate freely in case of an explosion"

In discussing the extinguishing of fires, Sax makes the following remarks about metal fires:

"Fires caused by burning metals are very difficult to extinguish and cannot be handled in the ordinary manner. For instance, to spray water upon burning metal might cause an explosion which would spatter flaming particles of metal to great distances. Usually the best way to attack burning metal is with specially formulated dry type fire-extinguishing agents. For instance, when one is planning to use a metal in a form in which it might readily become ignited, it is wise to discuss the situation with the manufacturer or supplier of this metal and obtain from him explicit instructions for the storage, handling, and

fire extinguishment of the metal. This is particularly applicable to the use of sodium, potassium, lithium, zirconium, uranium, thorium, and magnesium. For instance, it has been found that ordinary sand, even when dry, is a very poor material for extinguishing metal fires; it may react with the hot metal and add more heat to an already intense fire. Often salt (sodium chloride), sodium bicarbonate, graphite, magnesium carbonate, magnesium oxide, or mixtures of all of these materials have been found effective; in every case the supplier of this material will know how it must be handled. Water should never be applied to burning metals"

Industrial Hygiene (Industrial Health, Occupational Diseases, Occupational Hazards). Industrial hygiene is a branch of medical science dealing with principles and rules for preservation and improvement of health of those working in industry

Due to the fact that most explosives are toxic, particular care should be taken in handling them and the rules prescribed in books on Industrial Hygiene should be observed. The War departments of each country also have special rules applying to war plants, arsenals etc

See also Health Hazards of Explosives and Propellants in this Vol

Refs: 1) W. G. Thompson, Occupational Diseases, Appleton, NY (1914) 2) Great Britain Ministry of Munitions, Industrial Health and Efficiency, HMPO (London) (1918) 3) Courtois-Suffit et Zedet, Hygiene industrielle. Lutte contre les intoxications dans fabrications des poudres et explosifs, Bailliere, Paris (1932) 4) International Labor Office, Occupational and Social; Encyclopedia of Hygiene, Pathology and Social Welfare, Geneva (1930-1934) 5) G. Lutz, Gewerbehygiene, Wissenschaftliche, Verlags, Stuttgart (1933) 6) R. Fabre, Exposes de toxicologie et hygiene industrielle, Hermann, Paris (1935) 7) L. B. Chenoweth & W. Machle, Industrial Hygiene; A Handbook of Hygiene and Toxicology for Engineers and Plant Managers, Crofts & Co (1938) 8) J. B. Ficklen, Manual of Industrial Health Hazards, Service to Industry, West Hartford, Conn (1940) 9) L. I. Dublin & R. J. Vane, Occupational Hazards, US Govt Printing Office,

- Washington, DC (1942) 10) W. A. Cook, *Metal Finishing* **40**, 19-23, 25 (1942) (Industrial hygiene at work in defense industries) 11) G. Rodenacker, *Die chemischen Gewerbekrankheiten und ihre Behandlung*, Barth, Leipzig (1942) (Reproduced by Edwards Bros, Ann Arbor, Mich) 12) L. Schwartz, *Trans National Safety Congress* **31**, I, 173-8 (1942) (Occupational dermatoses in war industries) 13) I. R. Tabershaw & M. Bowditch, *New England JMed* **229**, 1003-7 (1943) & **231**, 706-10 (1944) (Industrial hygiene as applied to the manufacture of chemicals for munitions (51 references)) 14) R. Hussey, *IndHygFoundAmIncProc*, 8th Ann Meeting **1943**, 26-8 (The Army Industrial Hygiene Laboratory) 15) E. Rosser, K. B. Lehmann & F. Flury, *Toxicology & Hygiene of Industrial Solvents*, Williams & Wilkins, Baltimore (1943) 16) A. D. Brandt, *Manual of Industrial Hygiene*, Saunders, Philadelphia (1943) 17) J. E. Weiss, Ed, *Industrial Health, Occupational Hazards*, Inc, Cleveland, Ohio (1943) 18) US Public Health Service, *Industrial Hygiene & Medical Service in War Industries*, Saunders, Philadelphia (1943) 19) National Assoc of Manufactures of the USA, *Health on the Production Front*, NY (1944) 20) W. M. Gafafer, *Manual of Industrial Hygiene & Medical Service in War Industries*, Saunders Co, Philadelphia (1944) 20a) L. Schwartz, *Occupational & Related Dermatoses*, US Govt Print Office, Washington, DC (1944) 21) E. F. Bellingham et al, *US Public Health Service Bull* No 289, 95pp (1945) (Bibliography of industrial hygiene) 22) National Safety Council, *Industrial Safety and Health; A Bibliography* (1945) 23) N. V. Hendricks, *ChemMetEngrg* **53**, No 1, 124-5, 128 (1946) (Control of occupational hazards through industrial hygiene) 24) A. D. Brandt, *Industrial Health Engineering*, J. Wiley, NY (1947) 25) J. M. Dalla-Valle, *The Industrial Environment and Its Control*, Pitman, NY (1948) 26) R. T. Johnstone, *Occupational Medicine and Industrial Hygiene*, Mosby, St Louis (1948) 27) F. A. Patty, Ed, *Industrial Hygiene & Toxicology*, Interscience, NY, 2 vols (1948-1949), 2nd revised edition, (1958) 28) R. E. Kirk & D. F. Othmer, Eds, *Encyclopedia of Chemical Technology*, Interscience, NY, v 7 (1951), pp 847-870; C. H. Hine & L. Lewis, *Industrial Hygiene & Toxicology* (13 refs) 29) I. R. Sax "Dangerous Properties of Industrial Materials" (3rd Edit) Van Nostrand, Reinhold, NY (1968)
- Industrial Toxicology.** See under Toxicity & Toxicology
- Inert Gases' Explosive Compounds.** Until quite recently, the noble gases (Xe, Kr, A, Ne, Ra & He) were considered chemically inert and incapable of reaction with other elements. While this concept remains generally unchanged, at least a few noble gas compds can be prepd. Xe fluorides and oxyfluorides constitute the principle noble gas compds made to date. Scores of explns have been experienced during prepn and use of Xe fluorides, of which perhaps the following were the most serious:
- 1) An expt was being conducted in which a soln contg 0.39g of XeF₄ dissolved in 1.5ml of w was being evapd under vac at room temp to yield a white solid thought to be Xe(OH)₄ or XeO₂.2H₂O. While the silica container (under vac) was being heated gently with warm (30-40°) air from a blower, a deton took place which shattered the container and inflicted serious injuries (Ref 1)
 - 2) In Oct 1963, an expl occurred during heating of a 3" OD, 1/8" wall, 6 1/2" long cylindrical Ni reactor contg Xe and F gases. The incident was attributed to failure of a thermocouple-activated regulator which permitted pressure buildup beyond the rating of the vessel (Ref 5)
 - 3) An expln during Nov 1963 was attributed to reactions of moisture which entered a liq N₂ cold trap following failure of a mechanical pump over a weekend. It was presumed that the moisture reacted with XeF₆ in the trap to form expl XeO₃ (Ref 5)
- The case with which highly expl XeO₃ may be formed at room temp by reaction of Xe fluorides with moisture has been strongly emphasized (Refs 2, 3 & 4). Xenon trioxide, XeO₃, is a wh sol comparable in deton sensitivity to nitrogen triiodide and in expl force to TNT
- Refs: 1) N. Bartlett & P.R. Rao, *Science* **139**, 506 (1963) 2) D.F. Smith, *JACS* **85**, 816 (1963) 3) S.M. Williamson & C.W. Koch, *Science* **139**, 1046 (1963) 4) H.H. Hymen, *Noble Gas Compounds*, Univ of Chicago Press (1963) 5) Anon, *FLACS* (Florida Chem Soc) XVIII, 23-4 (1964)

Inert Simulants for High Explosives. In certain physical tests on weapons & explosives, eg the effects of humidity and temp cycling on the dimensional stability of the weapon, it is desirable to simulate the explosive filler by an inert filler. Many such inert simulants have been proposed and tested (Refs 1, 2 & 3). Simulants for Comp B & TNT have been patented (Ref 4). The simulant for Comp B consists of a mixt of 30% of 1,2 hydroxystearic acid, 5% wood rosin & 65% dead-burned gypsum. The simulant for TNT is a 40/60 mixt of hydroxystearic acid & dead-burned gypsum

A series of mock explosives to simulate PBX 9404, LX-04 & LX-10 has been developed in AEC laboratories

The composition, density, thermal properties & mechanical properties (elastic, viscoelastic & failure behavior) of these mock explosives are given in Ref 7

Refs: 1) A.J. Clear & O.E. Sheffield, "Inert Simulants for High Explosives," PATR 1618 (July 1946) 2) O.E. Sheffield, "Development of Inert Materials to Simulate Explosives," PATR 1667 (Oct 1947) 3) I.L. Kintish & N.D. Baron, "Use of Perlite to Improve Calcined Gypsum/Water Inert Filler," PATR 2340 (Oct 1956) 4) I.R. Kintish & J.E. Ranier, USP 3119705 (1964) & CA 60, 9094 (1964) 5) W.W. Bechtel, "Borax 5 Mol as an Inert Substitute for Pressed Explosives", PA Tech Memo 1747 (Nov 1965) 6) M. Roth, "Development of a Dimensionally Stable Inert Filler for Ammunition", PATR 3283 (may 1966) 7) B.M. Dobratz, "Properties of Chemical Explosives & Explosive Simulants", UCRL-51319 (1972), pp 12-1 to 16-8

Inertial, Terrestrial and Celestial Guidance Systems for Missiles. An *inertial guidance* system is one which is independent of information, other than gravitational effects, obtd from outside the missile

Missile guidance, wherein the predetermined path set into the control system of a missile can be followed by a device in the missile which reacts to some property of the earth such as magnetic or gravitational effects, is known as *terrestrial reference guidance*

A system wherein a missile, suitably instrumented and containing all necessary guidance

equipment, may follow a predetermined course in space with ref primarily to the relative positions of the missile and certain preselected celestial bodies is called an *inertial-celestial guidance system*

Ref: A.S. Locke et al, "Guidance," Van Nostrand, NY (1955), pp 583-95

Infallible Powder. One of the old duPont explosives

Ref: Marshall, I, p 330

Infallible Propellant. A double-base propnt consisting of NC (13.25%N) 59.25, NG 40.00 & DPhA 0.75%, coated with graphite. Grains 0.055 inch in diam & 0.007 inch thick when subjected to 65.5° Surveillance Test and 120° & 134.5° Heat tests were of satisfactory stability

Ref: W.H. Rinckenbach, "The Stability of Double-Base Powders," PATR 1359 (Oct 1943), p 2 & Table IV

Infantry Rocket Weapons. The title of a paper by Major Brill in Ordnance (Ref 1), where a brief description is given of the following weapons:

1) *Rocket Launcher, 2.36 inch*, known as *Bazooka*, developed in 1942. It was 54" long and weighed 12 lbs; could penetrate up to 4" armor at close range. Used successfully during WWII (Ref 1, p 629) (See also *Bazooka* in Vol 2, p B26)

2) *Rocket Launcher, 3.5 inch*, is the modern successor of original 2.36 inch launcher. Used successfully during Korean War

Note: Both launchers used non-guided missiles until 1959, when US Govt adopted French, anti-tank, wire-guided missiles *SS10* & *SS11*. The *SS10* is no longer in the US Army inventory and *SS11* has been adopted to helicopter armament as the *M22*, but for ground use it was replaced by the *Entac Missile* (Ref 1, p 630)

3) *Entac/Engin Téléguidé Anti-Char* (Tele-guided Antitank Device). A French boxlike launcher using a solid-propelled, wire-guided missile. The target is optically tracked by the infantryman. The missile is designed for use against tanks, armored combat vehicles and some defensive installations. It is armed with a HE shaped charge warhead. Total weight of the

launcher and missile is 37.5 lbs (Ref 1)

4) *Redeye*. A 3-inch weapon developed in US during the Vietnamese war & designed to provide combat troops in the forward battle area the capability of destroying low-flying aircraft. The length of its tubular-type launcher is 4 ft and the total wt of missile and launcher is ca 28 lbs. In its nose the missile carries an infrared sensing device which enables the guidance system of the missile to "home" on the heat of the enemy's aircraft engine. A small charge ejects the missile from its launcher and, at a distance far enough to protect the soldier from the rocket blast, a fuse ignites the major rocket charge. Miniature computer circuitry within the missile directs a set of steering fins which enable the missile to change direction as necessary and chase the target at supersonic speeds until it intercepts it (Refs 1 & 2)

5) *Light-Antitank Weapon (LAW), M72*, also known as *M72 Rocket Grenade*, is the smallest antitank weapon because its total wt is only 4.5 lbs and its length is 25 inches. It can be carried and fired by one man using its disposable packing container as a launcher. A telescopic aluminum inner section is extended prior to firing; the outer section is made of fiberglass-plastic composition. A solid-fuel rocket motor furnishes propulsion and burns out before the rocket leaves the launcher. When the missile emerges, several narrow magnesium fins (folded against the motor case when packed in the tube) spring into position and stabilize the missile (Ref 1, p 630)

6) *TOW (Tube-launched, Optically-tracked, Wire-guided) Weapon* has been developed to provide greater firepower than possible with Entac. Although similar to other antitank missile systems, TOW uses somewhat different guidance principles. The optically tracked missile is automatically guided in flights by commands transmitted by means of a 2-wire link between the gunner and the missile (Ref 1, p 630)

7) *MAW (Medium Assault Weapon)*. Two missiles have been under development during the Vietnamese War—one by industry and the other by the Research and Development Directorate of the Army Missile Command (Ref 1, p 630)

Refs: 1) Major J. H. Brill, *Ordn 50*, No 276,

628-30 (1966) 2) General Dynamics, Report, *Ordn 50*, No 276, 571 (1966)

Infernal Machines (Höllenschiffen in German; Engins Criminels in French; and Adskiyé Mashiny in Russian). Various devices used by anarchists, revolutionaries and criminals against kings, presidents, politicians and rich persons; also for sabotage. These devices consist of bombs, grenades and mines, and can be exploded either by instantaneous or time fuzes

Refs: 1) Daniel (1902), "Engins Criminels", pp 268-83 2) Stettbacher (1933), 417 (Anarchistenbomben) 3) A. Stettbacher, *Nitrozellulose 1938*, 75, 100 & 138 and *Schweiz-ChemZtg 1944*, 27-37 (11 Figs) 4) Stettbacher (1948), pp 130-32 (Sabotagezünder) (Sabotage Igniters) 5) Stettbacher, *Pölvoras* (1952), 164-66 (Bombas de Sabotage) 6) W. Powell, "The Anarchist Cookbook", Lyle Stuart Inc, NY (1971), Expls & Booby Traps, pp 132-51 7) K. Saxon, "The Poor Man's James Bond", *Atlas Formularies*, Eureka, California (1972), Bombs, pp 31-70

Inflammability or **Flammability** (latter is preferred in modern usage). The ease with which a material (gas, liquid or solid) will ignite, either spontaneously (pyrophoric), from exposure to a high-temperature environment (autoignition), or to a spark or open flame. It also involves the rate of spreading of a flame once it has started. The more readily ignition occurs, the more flammable the material; less easily ignited materials are said to be combustible, but the line of demarcation is often indefinite, and depends on the state of subdivision of the material as well as on its chemical nature

Closely related to inflammability is the general subject of *inflammable* or *flammable* (preferred) materials. These are defined as: any solid, liquid, vapor or gas that will ignite easily and burn rapidly. Flammable solids are of several types: (1) dusts or fine powders (metals or organic substances such as cellulose, flour, etc); (2) those that ignite spontaneously at low temperatures (white phosphorus); (3) those in which internal heat is built up by microbial or other degradation activity (fish meal, wet cellulosic materials); (4) films, fibers, and fabrics of low-ignition point materials

The National Fire Protection Association divides organic liquids into three classes: (1) those having a flash point (Tag closed cup) below 100°F (flammable, dangerous fire hazard); (2) those having a flash point at or above 100°F and below 140°F (flammable, moderate fire hazard); (3) those having a flash point at or above 140°F (combustible, slight fire hazard). Thus the critical flash point temperature for a flammable liquid is 140°F (Tag Closed Cup). However, shipping regulatory authorities (ICC, CG, IATA), as well as the Manufacturing Chemists Association, use 80°F (Tag Open Cup) as the critical flash point temperature

Flammable gases are ignited very easily; the flame and heat propagation rate is so great as to resemble an explosion, especially if the gas is confined. The most common flammable gases are hydrogen, carbon monoxide, acetylene and other hydrocarbon gases. Oxygen, though essential for the occurrence of combustion, is not itself either flammable or combustible; neither are the halogen gases, sulfur dioxide or nitrogen. Flammable gases are extremely dangerous fire hazards, and require precisely regulated storage conditions

Note: The terms "flammable," "nonflammable," and "combustible" are difficult to delimit. Since any material that will burn at any temperature is combustible by definition, it follows that this word covers all such materials, irrespective of their ease of ignition. Thus the term "flammable" actually applies to a special group of combustible materials that ignite easily and burn rapidly. Some materials (usually gases) classified in shipping and safety regulations as nonflammable are actually noncombustible. The distinction between these terms should not be overlooked. For example, sodium chloride, carbon tetrachloride and carbon dioxide are noncombustible; sugar, cellulose and ammonia are nonflammable

Ref: CondChemDict, 8th Edit, (1971), pp 391-2

Inflammability (Relative) of Dust Clouds. See also *Dust Explosions* in Vol 5, p D1578-R and *Ignition Temperature Tests* in this Vol. Relative Inflammability of a dust is defined as the percentage by weight of an inert dust, such as Fuller's earth, required in a mixture with the inflammable dust to prevent ignition and flame

propagation when the mixture is dispersed into a dust cloud in the presence of a standard source of ignition. The more inflammable the dust, the higher will be the percentage of inert dust needed to prevent ignition. This classification was adopted in the Bureau of Mines study of coal-mine dusts. The equipment used in these tests was the *Godbert-Greenwalt* apparatus and an open-spark inflammability apparatus

The former consists of an electrically heated vertical cylindrical tube (furnace), the top of which is connected to a small brass chamber containing the dust sample to be tested. A pneumatic system is used for blowing the dust downward thru the heated tube. In the usual ignition test, the lowest tube temp at which a flame appears at the lower mouth of the tube is taken as the *ignition temp* of the dust cloud. In the *relative inflammability test* the temp of the furnace is held constant at 700°C (1292°F) and only the amounts of Fuller's earth is decreased until no ignitions are observed

In the open-spark apparatus, a high voltage continuous spark having an average power of 20 to 24 watts is passed through a spark gap between tungsten electrodes in a pyrex tube, and the cloud of powder or dust being tested is blown thru the tube. The relative inflammability is determined as in the furnace test by finding the minimum amount of Fuller's earth needed in a mixture with the inflammable dust being tested to prevent ignition of the mixture by the spark

Ref: I. Hartmann & J. Nagy, USB of M, RI 3751 (1944)

Inflammability of Explosives Tests (Flammability Tests). See also **Index of Inflammability** in Vol 1, p XVII. These tests are designed to ascertain the behavior of explosives towards open flame. The following tests are described by Reilly (Ref 1):

Test No 1: Same test as *Fuse Test* described under *Ignition Sensitiveness*

Test No 2: A small sample of explosive is placed on an asbestos board and a small flame of a Bunsen burner is directed against it for 10 seconds. It is considered noninflammable if it does not ignite in this period. Control samples of known explosives should be included for comparison

Test No 3: If the explosive withstands the *Fuse Test*, it is subjected to the *Red Hot Iron Test* described under *Ignition Sensitiveness Tests*

Test No 4: Wood Fire Test: In some cases, larger quantities, ie a pound or two, are burned in a wood fire to ascertain the degree of danger the explosive may offer in case of fire. The observations should be made under precautions at a safe distance. (Compare with "Iron Box Test," described under *Ignition Sensitiveness*)

Test No 5: Ignition Time Test: A small quantity of the explosive is fastened to the end of a pendulum which swings through a flame in such a manner that the time required to ignite the sample can be measured. (For details, see under *Ignition Time of Test*)

Andrew & Kostin (Ref 2) describe an inflammability (or ignition) test for explosives in which a "donor" explosive is used to ignite an "acceptor" explosive placed below the donor in a 1cm diam vertical glass tube. As the density of the donor is decreased its igniting ability also decreases

Refs: 1) Reilly (1936), p 66 2) K.K. Andrew & I.D. Kostin, *CR Acad Sci (Russ)* **54**, 231 (1947) & *CA* **41**, 5307 (1947)

Inflammability or Flammability (preferred)

Limits. Gaseous fuels mixed with gaseous oxidants (usually air or oxygen) will ignite only within certain composition ranges. The max fuel-rich composition capable of ignition is known as the *upper flammability limit* and the min fuel-poor composition is known as the *lower flammability limit*. These vary widely with fuels and oxidants and are discussed under the individual gaseous fuels or vapors, eg see *acetylene gas* in Vol 1, p A59-L, or acetone vapor in Vol 1, p A34-L. General references on this subject include:

Refs: 1) H.F. Coward, "Limits of Inflammability of Gases and Vapors," *B of M Bull* **279** (Revised 1939) 2) L. Dollé, "Inflammability Limits of Vapors from Solids," *Magasin CTO*, Paris (1953) & *CA* **48**, 13222 (1954) 3) G. Dixon-Lewis & G.L. Isles, *Seventh Symposium (Intl) on Combustion* (1960) 4) B. Lewis & G. Von Elbe, "Combustion, Flames & Explosions of Gases," *AcadPres*, NY (1961)

Influence Tests. See **Detonation of Influence or Sympathetic Detonation Tests** in Vol 1 p X with additional information given below:

These tests are designed to measure the distance (usually in air) over which detonation may be conveyed from one explosive (donor) to another (acceptor)

In blasting operations it is important that an explosive be capable of transmitting detonation across an inert gap which interrupts the continuity of the explosive charge. The inert gap can be created in practice by air gaps, dirt or wads of paper getting between cartridge (sticks) of an explosive charge

It is important that transmission shall not be too poor, because this involves the danger that, if for any reason different cartridges are separated from one another by too great a distance, the entire charge might not be detonated. Some explosives transmit so poorly when frozen that detonation is incomplete even when there is no break in the continuity of the charge. Total or partial failure to detonate is a frequent cause of accidents, as the explosive is apt to go off in subsequent handling of the material being blasted. Accidents also occur in subsequent drilling of bore holes near unexploded charges

According to Marshall (Ref 1), a simple method of determining the distance of transmission, is to set out a row of small cartridges at increasing distances apart and to determine how many of them explode when the end cartridge is detonated

The distance at which the explosion is transmitted from donor to acceptor cartridge depends not only on the nature of the explosive itself (its sensitivity, brisance, power, velocity of detonation etc) but also on the following factors (provided both cartridges are from the same material and are of equal size):

- 1) Density of the explosive
- 2) Kind of medium through which the explosion is transmitted

Transmission of detonation is different for air gaps and dirt gaps. Transmission distances are much greater in v wet soil than in dry soil. In the open, distances (across air gaps) are shorter than in bore holes. In the open, the medium on which the cartridges are laid also

influence transmission distance: shortest gaps on porous media (loose soil) & longest gaps on dense media (steel)

3) Gaps increase as the cartridge diameter increases

Test Methods

The *gap test* or *halved cartridge test* is described in Vol 1, pp XIV & XV. Examples of the gap sensitivity (inches of air across which detonation is transmitted from donor to acceptor) are given below for US dynamites (Ref 6). Also see Vol 5, pp D1591 & D1737 (Table 5)

36 inches—for 60% ammonium gelatin containing NG 26.0, NC 0.4, NH_4NO_3 32.5, NaNO_3 29.5, wood flour 2.0, starch 2.7, ivory-nut meal 3.9, sulfur 2.0, lime 1.0. Vel of Deton 4900 m/sec; wt strength 67%

26 inches—for ammonium gelatin containing NG 26.0, NC 0.4, NH_4NO_3 57.2, red dog 4.0, clear flour 3.0, ivory-nut meal 4.4, starch 3.0, sulfur 2.0, lime 1.0. Vel of Deton 4800 m/sec; wt strength 61%

20 inches—for a dynamite containing NG 9.0, NH_4NO_3 42.0, NaNO_3 26.8, ivory-nut meal 13.7, fine buckwheat hulls 5.0, sulfur 3.0, lime 0.5. Vel of Deton 2700 m/sec

15 inches—for 20% ammonia dynamite containing NG 8.5, NH_4NO_3 16, NaNO_3 55.0, sulfur 6.5, fine buckwheat hulls 6.0, ivory-nut meal 7.0, lime 1.0. Vel of Deton 2500 m/sec; wt strength 20.2%

10 inches—for dynamite containing NG 9.0, NH_4NO_3 75.0, NaNO_3 3.2, straw 12.3, lime 0.5. Vel of Deton 2700 m/sec; wt strength 67%

8 inches—for a permissible dynamite containing NG 10.0, NH_4NO_3 9.0, salt 2.5, oat straw 12.0, lime 0.5. Vel of Deton 2600 m/sec

4 inches—for a dynamite containing NG 10.5, NH_4NO_3 73.0, NaNO_3 4.0, wood pulp 9.0, balsawood 3.0, lime 0.5. Vel of Deton 2200 m/sec; wt strength 63%

2½ inches—for Pic Ars Low Velocity Dynamite (Ref 8)

1 inch—for Hercules Medium Velocity Dynamite (Ref 9)

From the above it is clear that gap sensitivity depends strongly on the NG content of the dynamite

Cook (Ref 7) suggests that S_c , the air gap over which detonation will be transmitted *solely*

by shock, is given by:

$$S_c^3 = kM$$

where k is a different constant for each explosive, and will depend on the density and physical state of the explosive; M is the weight of explosive

This equation will apply, on the other hand, only if one uses a primer of fixed L/d (length/diam), and k will be a maximum for any explosive of fixed composition, density, and granulation for L/d ~ 1.0. Also this relationship may be readily upset if there is a chance for the explosive to hurl solid fragments, because flying particles can set off an explosive over far greater distances via hot-spot mechanisms than the blast wave itself. In addition, k will depend upon how one expresses sensitiveness results. For example, the maximum distance for consistent detonations (100 per cent D, 0 per cent F) is usually roughly about one-half the minimum distance for consistent failures (0 per cent D, 100 per cent F). It is usually best to adopt the 50 per cent F point as the reference point for defining k, because this point can be most accurately established. That is, the per cent detonation versus gap distance curve is in general an S-shaped or probability curve

Refs: 1) Marshall, 2, (1917), 430; 3, p 128 2) Barnett, p 212 3) C.E. Munroe & J.E. Tiffany, Physical Testing of Explosives, USB of M, Bull 346, Washington (1931), pp 59-60 4) A. Pérez Ara, pp 112-13 5) C.E. Bichel, Testing of Explosives, London (1905), pp 49-50 6) I.A. Grageroff, Private Communication 7) Cook (1958), p 196 8) AMCP 706-177, (1971), p 123 9) Ibid, p 126

Modified Influence (Propagation) Test. Gawthrop (Ref 1) and others used a modified gap test to determine the relative ability of a shielded donor charge to transfer detonation over an air gap to an acceptor charge. Clark (Ref 2) also used this method for the determination of the gap in the transmission of detonation from a small charge (0.5 to 2g) of HE to a cartridge of 40% straight dynamite

For these tests, Clark placed a small charge of HE in a No 8 detonator shell and pressed it under a reinforcing capsule at 3400 psi. The detonator was placed centrally in a cylindrical oaken shield, with its long axis parallel to and

coinciding with the long axis of the shield and with its base flush with the end of the shield. The shield containing the detonator and the cartridge of acceptor explosive (40% dynamite), with the cut end facing the detonator, were then wrapped in three layers of heavy paper

The maximum gap through which detonation would be transferred with certainty was determined in four trials

Modified Gap Test results are given in the following tabulation (which shows that DDNP is an efficient donor):

Modified Gap Tests		
Detonator Base Charge	Wt of Base Charge (g)	Max Air Gap over which Detonation of 40% Straight Dynamite Occurs (cm)
DDNP	0.50	350
MF	0.50	150
MF	1.00	300
Tetryl primed with LA	0.66	400
PA primed with MF	1.25	300
MF-KClO ₃ (80:20)	2.12	90
MF-KClO ₃ (80:20)	1.05	100
Lead styphnate	1.74	50
Nitromannite--		
Mercury fulminate	1.16	90

Results are strongly influenced by the tube in which tests are conducted. The following tabulation (Ref 3) shows that tests in iron tubes result in much longer gaps than tests in paper tubes:

Explosive	Weight of Charge (g)	Gap, in meters through	
		Paper Tube	Iron Pipe
Pentryl*	0.50	4.00	16.5
DDNP	0.50	3.50	—
MF	0.50	1.50	—
MF	1.00	3.00	—
Tetryl primed with MF	1.34	2.50	12.5
Tetryl primed with LA	0.66	4.00	—
PA primed with MF	1.25	3.00	12.5
MF/KClO ₃ (80:20)	2.12	0.90	3.5
MF/KClO ₃ (80:20)	1.05	1.00	—
Lead Styphnate	1.74	0.50	3.5
Nitromannite--			
Mercuric fulminate	1.16	0.90	12.5

*Primed with 0.20g of MF (reinforced)

Refs: 1) D.B. Gawthrop, JFrankInst, 214, No 6, p 647 (1932) 2) LeRoy V. Clark, IEC 25, 668 (1933) 3) Ibid, p 1388

Infrared Guidance Systems. See German section under Guidance Systems for Missiles in Vol 6

Infrared Spectroscopy, Application to Explosives & Propellants. The infrared region is that portion of the electromagnetic spectrum which is located between visible light and the microwave radio region. It is conveniently divided into *near infrared*, which extends from the edge of visible light (0.0008mm, 0.8 μ or 8000 angstroms) to about 0.025mm (25 μ or 250,000 angstroms) and the *far infrared*, which extends from the near infrared to about 1mm (1000 μ or 10 million angstroms). The region up to about 0.002mm (2 μ or 20,000 Å) of the near infrared is called *photographic or photoelectric* because radiation in this region is readily detected photographically or photoelectrically

Infrared (IR) radiation can be dispersed into a spectrum by means of coarse diffraction gratings or prisms of special material, such as rock salt, which is transparent to much longer waves than glass, after which the rays can be detected with a device which is sensitive to small heating effects such as bolometers, thermocouples and various other radiometers

The infrared spectrum (especially the near-infrared) has assumed great importance in chemical and biological research because of the highly specific absorption of chemical compounds at these wavelengths. The infrared absorption of a given organic compound may be used to characterize that particular compound. The infrared spectrum of a mixture of several compounds among which there is no interaction, does not lie between the spectra of the individual compounds, but consists of a direct superposition of the spectra of the individual compounds

A general reference on IR spectroscopy is Ref 7

Application of infrared (IR) spectroscopy to the study of explosives & propellants can be divided into three general areas:

1) Identification and quantitative estimation of unreacted explosives, propellants & inert ingredients in expl & proplnt compositions

2) Study of the composition of combustion or explosion products. With rapid scan spectro-

meters such studies can provide kinetic data

3) Study of the intermediates or equilibrium composition in the preparation of explosives

Most of the published work belongs in area 1). Particularly pertinent are the studies of Pristera et al (Refs 2 & 12) on IR spectra of explosives & the identification of the ingredients of a complex propellant (Ref 2). In Ref 12, Pristera gives the IR spectra of: **EDNA, MEDINA, α , β & γ HMX, Tetryl, BTTN, NC, DEGN, Manitol Hexanitrate, Metriol Trinitrate, NG, PETN, TEGN, 1,5-Dinitronaphthalene, 1,8-Dinitronaphthalene, 1,3,8-Trinitronaphthalene, 2,4-DNT, TNT, AN, Ammonium Picrate & 1,3,6,8-Tetranitrocarbazole**. Further information on other explosives, explosive mixtures and the inert ingredients in these mixtures is contained in Ref 1

The following tabulation (from Leclercq in Ref 8) shows the symmetric & antisymmetric stretch frequencies of the N-O bond in various compounds:

Compound	Sym freq (cm^{-1})	Antisym freq (cm^{-1})
RNO ₂	1500-1550	1320-1360
RNNO ₂	1550-1600	1200-1260
RONO ₂	1600-1660	1250-1300
Metal NO ₃	one band only at 1350-1400 cm^{-1}	

IR spectra of nitroaliphatic compounds are reviewed by Slovetskii (Ref 13). This review contains 237 references thru 1969

In the absence of conjugation N₃ absorption bands of organic azides occur in the 2100-2110 cm^{-1} region (Ref 9). Conjugation or presence of electron acceptor groups shift the bands to 2135-2166 cm^{-1} . It is claimed that for organic azide measurement of band intensity is a more sensitive indication of compound structure than measurement of band position. Electron donor groups in the molecule increase band intensity and electron acceptors lower it

IR spectra of inorganic azides are given in a review by Yoffe (Ref 10)

IR and Raman spectra of NF compounds are reviewed by Moskvitina & Kuzyakov (Ref 14). Their review contains 47 references

Pristera has developed an IR method for determining α , β & γ TNT as well as 2,4-DNT in mixtures such as found in exudates (Ref 1)

Castelli et al (Ref 3) worked out a rapid IR method for determining NG, TA & 2-Nitrodiphenylamine in Casting Solvent

Examples of studies belonging to area 2) are:

Studies by Crawford & Rotenberg (Ref 4) who used a rapid-scan spectrometer in conjunction with a strand burning apparatus to examine NG-NC "low" temperature decomposition and flames. During the decomposition of commercial double-base propellants, the gas products were: NO, N₂O, CO₂ & CO. When these propellants were burned under 100-150 psi nitrogen pressure at a linear velocity of ~ 100 cm/sec, CO₂ & CO absorption bands appeared even at 2 cm away from the burning surface. Nitric oxide was barely detectable and N₂O was completely absent

Leclercq gives some IR spectra for residues of explosive that had been burned (Ref 8)

Zirkind reviews investigations of radiation emission of rocket exhausts since 1940 (Ref 11). Emission characteristics of the exhaust plume are strongly dependent on rocket engine parameters & the propellant system. If these & motor operating conditions are stipulated, machine computations can give exhaust composition & sometimes temperatures

Examples of studies pertaining to area 3) are:

Simecek's study of the preparation of the lower nitrates of PETN and measurement of their IR spectra (Ref 6)

Leclercq's study of the nitration of amyl alcohol and cellulose by following the amount of OH remaining after nitration by IR absorption methods (Ref 5)

Refs: 1) F. Pristera, *Appl Spectroscopy* **7** (3), 115 (1953) & *CA* **48**, 1683 (1954) 2) F. Pristera, *Anal Chem* **25**, 844 (1953) 3) A.H. Castelli et al, *PATR* **2021** (1954) 4) B.L. Crawford & D.L. Rotenberg, *IEC* **48**, 759 (1956) & *CA* **50**, 9875 (1956) 5) M. Leclercq, *MP* **43**, 369 (1961) & *CA* **57**, 6766 (1962) 6) J. Simecek, *Collection Czech Chem Commun* **27**, 362 (1962) & *CA* **57**, 647 (1963) 7) H.A. Szymanski, "IR: Theory & Practice of Infrared Spectroscopy," Plenum Press, NY (1964) 8) M. Leclercq, *MP* **45**, 207 (1963) & *CA* **63**, 2838 (1965) 9) Yu. N. Sheinker & L.B. Senyavina, *Izv AkadNauk, SSSR, Ser Khim* **1964** (11), 2113 & *CA* **62**, 9942 10) A.D. Yoffe, *Develop Inorg Nitrogen Chem* **1**, 72 (1966) & *CA* **66**, 34318 (1967) 11) R. Zirkind, 11th

Sympos of Combust 613 (1966) & CA 68, 41732 (1968) 12) F. Pristera, *Encycl of Ind Chem Analysis* 12 (1971), pp 453-60 13) V.I. Slovetskii, *UspKhim* 40 (4), 740 (1971) & CA 75, 12493 (1971) 14) E.N. Moskvitina & Yu.Ya. Kuzyakov, *Kolebatel'nye Spektry Neorg Khim* 1971, 101 & CA 75, 55519 (1971)

Influence Test. See Gap Test in Vol 1, p XIV

Infusorial Earth. See Kieselguhr in this Vol

Ingelita. See Antigél de Sûreté in Vol 1, p A466-R

Ingold, C.K. (1893-1970). English physico-organic chemist whose pioneering research helped to lay the basis of modern organic chemistry. His work on nitration reactions did much to elucidate the mechanism of these reactions, particularly the nitration of aromatic compounds. He became a fellow of the Royal Society in 1924 & was knighted in 1958. He was the recipient of many scientific honors & medals
Refs: 1) "World Who's Who in Science," (A. G. Debus, Ed), Marquis, Chicago (1968) 2) C & EN 49 (3), 41 (1971) & CA 74, 106995 (1971)

Inhabited Building. In the American Table of Distances for Storage of Explosives, an "Inhabited Building" is defined as: "A building regularly occupied in whole or in part as a habitation for human beings, or any church, schoolhouse, railroad station, store or other structure where people are accustomed to assemble, except any building or structure occupied in connection with the manufacture, transportation, storage, or use of explosives"
Ref: American Table of Distances for Storage of Explosives as Revised & Approved by the Institute of Makers of Explosives, Sept 30, 1955

Inhibiting of Solid Propellant Grains. To prevent surface burning and/or contact of the propellant grain with its container, various methods of deactivating and/or coating of the grain surface are used. This is called "Inhibiting" the grain

Inhibitors or restrictors are applied to those surfaces of the grain where burning is to be prevented. They consist of plastic materials

which are sometimes charged with an inert refractory filler (chalk powder) and burn very slowly if at all. Sheets of cellulose acetate or ethyl cellulose, 2 to 4mm thick, have been widely used for that purpose but cellulose acetate is not very satisfactory with double-base propellants because of the exudation of nitroglycerine during storage. With composite propellants the fuel, with an inert filler substituted for the oxidizer, is also often used. Restrictors can be applied by dipping the grain or by spraying the inhibiting material on. These two methods are not very satisfactory because each coat must be very thin to dry well and a prohibitively large number of applications are required to build up the desired thickness. Preferably inhibitor sheets are bonded to the grain, possibly under pressure at fairly high temperature, with a suitable glue like polyurethane, or a restricting tape is wrapped around the grain

The mechanical and physical properties of the inhibiting material must be fairly similar to those of the propellant in order to minimize the differential expansion. In this respect the use of several layers with possibly different compositions is favorable. With long burning timers (more than 20 sec) the development of a reliable inhibitor poses a fairly difficult problem, especially with end-burning grains. The situation is greatly improved in this respect when the inhibitor is not in contact with the hot gases. This is the case with case-bonded grains where the thin chamber liner acts as restrictor (Ref 2)

Inhibiting by Denitration. This consists of the removal of the nitrate groups from the surface of the propellant grain by treating it with ammonium hydrogen sulfide and ammonium polysulfide. Previous to this treatment, however, the surface of the grain is swelled by a one minute dip in acetone (contg 5% by wt of AcOH), followed by one hour drying

The denitration solution is prepd by dissolving 8 parts by wt of ammonium hydrogen sulfide in 92 parts of alcohol (30% soln by volume). This aqueous solution is circulated over the grains for about 2 hours during which time the soln is kept up to strength by adding H₂S gas. The grains are then removed from the

denitrating bath and, after rinsing them quickly with water, placed in a dilute glycerin soln at 40° for two hours. Finally the grains are dried by wiping and then stored. This method gives grains with denitrated layers as thick as 0.018". These layers do not burn during firing but are left as a residue. Various kinds of grains were treated by this method, including Mk31 grains and triangular catapult grains. The powders prep'd by this method proved to be fairly non-hygroscopic and stable in storage

Spiral Wrapping Process consists of wrapping around large cylindrical grains of powder (such as Mk31) a thin tape of inert, non-explosive material (such as cellulose acetate, ethyl cellulose) in order to create a protective, non-combustible layer. Wrapping is done on machines which resemble a shop lathe. Usually 6 layers of tape are applied to make a layer about 0.045 inches thick

Inhibiting of Cast Double-Base Grains. A good inhibitor should bond to the grain with a strength equal to the grain strength itself. It should also have about the same coefficient of expansion as the grain material

Alleghany Ballistic Laboratory found that casting grains in convolute-wound or extruded beakers is quite satisfactory. In the spiral wrapping process they had to use solvent-type adhesives, but would prefer to use a non-solvent type

When using large grains with internal perforations, the problem of NG migration is not of great importance, because the outer inhibited cylindrical surface forms only a small percent of the total operating surface. After up to two years in storage at 120°F, booster grains were still in good condition

Inhibiting of Double-Base Catapult Propellants with Ethyl Cellosolve Gel Lacquers. Propellants for slotted tube catapults are designed to produce a const press system in the catapult tube. Catapult propellants usually have non-circular cross-sections and are completely externally inhibited

An ideal inhibitor is one which burns through at the same time that the powder web is exhausted so that no residue remains in the catapult. A dipping process was

employed to coat the grain with inhibitor. Viscous gel lacquers were used in this process with viscosities of 8,000-10,000 centipoises at the dipping temperature. The solvents were adjusted so that there was a sharp increase in viscosity as the temp was lowered towards room temp. As the dipped grain is withdrawn from the warm lacquer the coating sets due to solvent evaporation and gelation caused by the temp drop. In this way running and sagging are minimized and a substantial coating can be applied with a single dip. If a very thick coat (such as 0.10") is required, 3 to 4 dips are necessary

Most of the grains are 15 to 18" in length and the major diameters range from 0.8" for small experimental catapults to 3-3¼" for Field Installations. Inhibitor thicknesses are between 50 and 100 mils

Gel lacquer formulations used for dip coating. The early catapult propellants were inhibited by dipping in a lacquer consisting of toluene 80p, acetone 20p and a total solids content of 15-18%. The grains were dipped twice and had a cured inhibitor thickness of 20 to 30 mils. As the size of experimental slotted tube catapults increased, coatings of 100 mils were required. This necessitated an increase of the solid content to 25-27%. As this soln was too viscous some methylol was incorporated in solvent formulation. In order to improve the room temp gelling characteristics an aliphatic hydrocarbon was added

With this system there is no serious curing problem for coatings under 50 mils thick, but for coatings of the order of 100 mils, about three weeks are required to remove the volatile solvents

Castable Cellulose Acetate Inhibitors for Rocket Propellants. During the joint development of the propellant for the T34 Jato by PA & Hercules, it became desirable to investigate methods of restricting the ends of the powder grains. Since it was difficult to obtain uniformly good bonding and satisfactory inhibiting by cementing cellulose acetate sheets to the ends of large prop grains, the possibility of using some form of inert powder for this purpose was investigated. The inert casting powder adopted consisted of 90% cellulose acetate and 10% dimethyl phthalate in 0.30" x 0.030" granulation

A layer of this inert powder was placed in an extruded cellulose acetate tube, partly filled with OGK casting powder (NC of 12% 88, 2-nitrodiphenylamine 2, dioctylphthalate 5 and lead stearate 5%) and was then covered over with more OGK powder

OGK casting solvent (72% NG, 27% triacetin and 1% nitrodiphenylamine) was then fed through the entire mass, following which the assembly was cured at 140°F. After curing the charge was sectioned and examined. The granules of inert powder had gelled and hardened, forming a well consolidated mass which was very well bonded to, and almost undistinguishable from, both the OGK powder and the extruded tube

A solid casting was prep'd consisting of inert casting powder and OGK casting solvent. The chemical analysis of the cured charge gave NG 28.0, 2-NPhA 0.4, cellulose acetate 55.1, DMePh 6.1, Triacetin 10.4%. The heat of combustion was 3790 cal/g. The heat of explosion was 260 cal/g

Strands of this material would not burn in the inert atmosphere of the Crawford type bomb, but they burned in air at 70°F at the rate of 0.023" per second. This compared with a burning rate for H9 propellant of 0.097"/sec at 1 atm and 0.36"/sec at 1000 psi & 70°F

This cast cellulose acetate material has been employed for end restricting 8½" and 20" diameter perforated cast OGK grains and thermally cycled JATO motors at -65, +70, +165°F. No cracks or separations of the cast acetate restrictions were observed but some softening and deformation was noted after conditioning at +165°F. These rounds functioned satisfactorily when fired at either -65 or +165°F

Inhibiting Double Base Rocket Propellants at Picatinny Arsenal. Most of the work at Picatinny Arsn in connection with inhibiting of solventless extruded or cast double-base propellant has been with *convolute* wrappings of grains or tubes with cellulose acetate. There has been a trend toward use of extruded tubes made by the casting process

When convolute wrapping of the long grain for the T200 Rocket (4.5" diam and 72" long) proved unsuccessful, a procedure was investigated for inhibiting with *Thiocol* composition developed at PA (see 6th JANAF Sol

Prop Meet), but this method proved to be not very satisfactory on account of the appreciable migration of NG into the inhibitor, which resulted in its deterioration at elevated temp. Migration occurs also when using cellulose acetate inhibitors

An attempt to prevent migration of NG by inserting a layer of cellophane after the first cellulose acetate wrap proved to be unsuccessful because of the poor bond between cellulose acetate and cellophane

Refs: 1) 7th JANAF Meeting, April 16-18 (1951)
2) M. Barrère, A. Jaumotte, B.F. de Veubeke & J. Vandekerckhove, "Rocket Propulsion", Elsevier Publ'g Co, Amsterdam, Netherlands (1960)

Inhibitors. Substances which slow down or stop a chemical reaction. For instance, some substances act as corrosion inhibitors, others are added to explosives to prevent their decomposition in storage (see below)

Inhibitors in Explosives. Substances added to explosives in order to take up the nitrogen oxides formed during storage or to neutralize residual acids or acids formed during storage. The presence of NO₂ and other nitrogen oxides and/or acids in explosives (especially in smokeless powders and dynamites) is very undesirable because they act as catalyzers and promote further, more rapid decomposition. Most of the stabilizers used in smokeless powder, such as diphenylamine, centralites, urethanes etc are really inhibitors because they react with NO₂ and other nitrogen oxides to form nitroso- and nitrocompounds. Acid neutralizers such as chalk are added to dynamites

Inhibitor Strips for Smokeless Powders. In order to control the burning area of large grain smokeless powders and to prevent the grains from coming into contact with the rocket motor walls, inhibitor strips (consisting of ethylcellulose (or cellulose acetate) 74, dibutyl phthalate 4, diethyl phthalate 16 and dimethyl phthalate 6%) are pre-glued to the surface of grains. This is done by means of adhesives consisting of solns of NC in ethyl acetate, Cellosolve, mesityl oxide, Bu acetate etc, which act as a mutual plasticizer for the

powder and the material of the inhibitor strip

Ref: A.M. Ball, USP 2643611 (1953) & CA 47, 9016 (1953)

Initial Velocity. Same as Muzzle Velocity—see under *Ballistic Tests* and *Ballistics* in Vol 1, p B5-R & B7-L & additional French refs:

1) R. Rousselet et al, MAF 22, 171-190 (1948), Measurement of initial velocities of projectiles at the battlefield

2) R. Rousselet, MAF 22, 649-655 (1948), Use of a fluxmeter by Grassot for measuring initial velocities of projectiles at the testing range

3) M.C. Thatcher, MAF 23, 305-308 (1949), Measurements of the initial velocities of projectiles (Translated from the English)

Pepin Lehalleur, p 110, gives initial velocities for some French and foreign propellants

Initiating Devices. See *Detonators, Igniters, Primers, and Other Initiating Devices used for Nonmilitary and Military Purposes* in Vol 4, pp D733-D928

Initiating Explosives. (Initial Detonating Agents; Primary Explosives) (Zündsprengstoffe in Ger) Sometimes erroneously called Priming Compounds, are substances used in small quantities, which on being subjected to the action of flame (produced by primers or other means), heat, impact, friction or an electric spark, generate a detonation wave. The detonation of the primary explosive initiates detonation in a larger quantity of explosive ("main" charge or "base" charge) which usually possesses higher brisance, power and velocity of detonation than the initiating explosive

The main requirements for initiating explosives are: 1) sufficient sensitivity to heat, flame or impact etc that they can be readily detonated, but not so sensitive as to make them unsafe to handle and transport; 2) sufficient stability at elevated temperatures that they will not decompose while stored in ammunition, thus rendering it unusable. Brisance, power and velocity of detonation are of secondary importance in these explosives

There are many explosives which could serve as initiating agents if they were not too danger-

ous to handle and too unstable in storage. The most frequently used initiating substances are: Lead Azide, Mercuric Fulminate with or without Potassium Chlorate, Lead Styphnate, Cyanuric Triazide, Tetracene and Diazodinitrophenol

The following substances are also good initiating agents but have not found much use: Silver Azide, Cadmium Azide, Cupric Azide, Triazidotrinitrobenzene, Chloratotrimercuraldehyde, Nitrogen Sulfide & Hexamethylenetriperoxidodiamine

Until WWI, Mercuric Fulminate was the principle initiating agent used, but Lead Azide has now replaced it. Lead azide is not the most powerful azide, but is more stable and less dangerous to handle than some of the other ones. Cadmium Azide, for example, is more powerful than Lead Azide but is unsuitable as an initiating agent because it is difficult to prepare and is soluble in water

Marshall (Ref 13, p 158) gives the effectiveness of various azides and fulminates as initiators. No 1 is the most effective and No 11 is the least effective:

1) Cd Azide 2) Cd Fulminate 3) Ag Azide 4) Ag Fulminate 5) Lead Azide 6) Cuprous Azide 7) Cuprous Fulminate 8) Mercurous Azide 9) Mercuric Fulminate 10) Tellurium Azide 11) Tellurium Fulminate

For the preparation and properties of initiating agents, look under the individual compounds

Refs: 1) Commission des Substances Explosives, MP 12, 134-55 (1903-04) 1a) L. Wöhler & O. Matter, SS 2, 181, 203, 244 & 265 (1907) 2) L. Wöhler & F. Martin, SS 12, 242-43 (1914) 3) A. Stettbacher, SS 12, 341, 355, 381 & 391 (1914) 4) R. Escales & A. Stettbacher, "Initial Explosivstoffe", Leipzig (1917) 5) Marshall 2 (1917), 506-13 6) C.A. Taylor & W.H. Rinkenbach, JFrankInst 196, 551 (1923) 7) C.A. Taylor & W.H. Rinkenbach, Army Ordnance 5, 463 (1924) 8) L. Wöhler, SS 20, 145 & 165 (1925); SS 21, 1, 35, 55, 97 & 121 (1926) 9) L. Wöhler et al, SS 22, 95 & 135 (1928) 10) B. Cserneczky, SS 23, 169 (1929) 11) A. Stettbacher, SS 23, 383-88 (1929) 12) A. Heinemann, Nitrocellulose 1, 196 (1930) (A review of initiating expls) 13) Marshall 3 (1932), 158-62 14) Stettbacher (1933), 324 15) R. Wallbaum, SS 34, 126, 161 & 197 (1939) & CA 33, 7569

(1939) 16) H. Muraour, MAF **18**, 895 (1939) & CA **34**, 4905 (1940) 17) Davis (1943), 400-58 (under Primers) 18) L.V.R. Clark, USP 2326008 & 2325742 (1943) & CA **38**, 488-90 (1944) 19) R. Schmitt, SS **38**, 133 (1943) & CA **38**, 2822 (1944) 20) K.K. Andreev, DR Acad Sci (Russia) **44**, 18 (1944) & CA **39**, 813 (1945) 21) Pérez Ara (1945), 557 & 647 22) C. Francais, FrPat 856366 (1946) & CA **42**, 2774 (1948) 23) Stettbacher (1948), 95 24) Bowden & Yoffe (1952) 25) Bowden & Yoffe (1958) 26) Baum, Stanyukovitch & Shekhter (1959) 27) W.H. Rinkenbach in Kirk & Othmer, Vol **8** (1965), 583-93 (Initial Detonating Agents) 28) B.A. Bydal, "Percussion Primer Mixes", Ordnance, Vol **LVI**, No 309, 230-33 (Nov-Dec 1971) (A review of the history of initiating explosives from their discovery early in the seventeenth century up to the development of today's safer noncorrosive, nonmercuric mixes) 29) O.E. Sheffield & W.R. Tomlinson Jr, "Properties of Explosives of Military Interest", AMCP **706-177** (Jan 1971) 30) Anon, "Principles of Explosive Behavior", AMCP **706-180** (April 1972)

INITIATION

In its strictest sense *Initiation* is the generation of initial conditions that lead to stable detonation. However, it is common usage also to refer to the first stages of deflagration and explosion as initiation. Thus it is often difficult to differentiate between "initiation" and "ignition." It is generally accepted that initiation is a thermal process which requires an external stimulus (except for "spontaneous" ignition) to get it started. Regardless of the nature of this external stimulus, a necessary condition for initiation is that heat generated in the explosive (that is "initiated") exceed all heat losses by the explosive. Since heat generation (chemical decomposition) increases exponentially with rising temperature, but heat losses are roughly proportional to temperature to the first power, any stimulus that generates a high enough temperature in an explosive is apt to "initiate" that explosive. Conversely, an explosive in which exothermic reaction is readily started by a variety of external stimuli, is said to

be a "sensitive" explosive. Thus the ease of initiation is closely connected with *explosive sensitivity*, but it must be emphasized that "explosive sensitivity" depends not only on ease of initiation but also on the ease of growth and *propagation* of whatever process was "initiated." It is entirely possible that highly localized regions of an explosive are "initiated" but the processes in these regions die out without propagating

Because initiation is such a fundamental part of explosion and detonation phenomena various aspects of initiation have already been described in previous volumes and in this volume of the Encyclopedia. Particularly pertinent are the articles on *Deflagration*, Vol **3**, pp D38-40; *Detonation* (and Explosion), *Initiation and Propagation*, Vol **4**, pp D402-419; *Hot Spots & Ignition* in this Vol

In what follows we will give brief definitions or descriptions (whenever necessary) of various modes of initiation of condensed explosives, ie, various external stimuli that produce initiation, and provide references to Encyclopedia articles where these modes of initiation are discussed in detail

Initiation by Booster. See below under *Initiation by Primers*

Initiation by Bullet Impact is a special case of *Initiation by Projectile Impact*. See *Bullet Tests* in Vol **2**, pp B332-340 and Vol **4**, p D153; also under *Projectile Impact* below

Initiation by Electric Fields. Silver Azide can be initiated by DC fields of ca 70v (min field strength for explosion ca 250v/cm) at extremely low current flow (Bowden & Yoffe "Fast Reactions in Solids Acad Press (1958) p 101). Maycock & Grabenstein [Science **152**, 508 (1966) & CA **65**, 562 (1966)] have postulated that piezoelectric effects generated by compressing explosive crystals may generate sufficiently large electric fields to initiate these crystals

Initiation by Electron Beams. According to Bowden & Yoffe ("Fast Reactions in Solids" Acad Press, 1958, p 114) the initiation of lead & silver azides by an electron beam is at least in part due to bulk heating of the

explosives by the beam. Pulsed electron beams have been used to initiate explosives and study their shock properties (J.H. Shea et al, ONR Symp Det (1970) p 351). See also *Electrons & Neutrons Action on Explosives* in Vol 5, p E77

Initiation by Electrostatic Discharge. This is described in detail under *Electricity; Extraneous Hazards Associated With It* in Vol 5, pp E36-54. See also *Initiation by Sparks*

Initiation by Exploding Bridge-Wire is generally considered to be special case of *Initiation by Shock*. For details see *Exploding Bridge-Wire Initiation* in Vol 6, pp E355-56 and under *Exploding Bridge-Wire (EBW) Detonators* in Vol 4, pp D 807-810 and *Electrical Explosion* in Vol 5, p E23. An additional reference is T.J. Tucker, Proc Symp on Behavior & Utilization of Explosives in Engineering Design (1972), pp 179-182

Initiation by Fission Fragments. All attempts to initiate explosives by nuclear fission fragments such as α -particles, protons, Ar or Hg ions, γ -rays, X-rays, mesons and pions have resulted in failures [Bowden & Yoffe quoted above, & J. Cerny & J.V.R. Kaufman, JChemPhys 40 (6), 1736 (1964)]

Initiation by Flame. Various aspects of this process were described under *Burning and Combustion*, Vol 2, pp B343-346; *Dead-Pressed Explosives*, Vol 3, p D20; *Ignition* in this Vol; *Thermal Explosion* in a future Vol

Initiation by Friction. See *Friction Sensitivity Tests* in Vol 6, p F204-L and *Hot Spots & Impact* in this Vol

Initiation (of Condensed Explosives) by Gas Detonations does not involve the same phenomena as *Initiation by Primers or Boosters*. The pressures generated in gas detonations are too low to produce sufficiently intense shocks in condensed explosives for shock phenomena to play a major role in the initiation of the latter. Even the energetic $C_2H_2 + O_2$ detonation produces a detonation pressure of only ca 43 atm for an initial gas pressure of 1 atm. The max shock

pressure produced by reflecting the oxy-acetylene detonation wave is only ca 0.2 to 0.3 kbars. Thus gas detonations initiate condensed explosives (if at all) by some direct heat transfer process. In oxy-acetylene detonations, the equilibrium temperature (CJ temp) is quite high $\sim 4500^\circ K$

The writer (unpublished results) was able to initiate Lead Azide pellets of ca 2.5 g/cc density with oxy-acetylene detonations. However ca 1.2 g/cc PETN pellet could not be initiated under these conditions. Gordeev et al [Nauchn-Tekhn Probl Goreniya; Vzryva (1965) p 12 & CA 64 1894 (1966)] succeeded in initiating liquid mixtures of tetranitromethane (TNM) and benzene with stoichiometric methane-oxygen detonations. For 1.5 vol parts of TNM & 1 vol p of benz the initial pressure, P_0 , of the detonating gas mixture had to be greater than 2 atm to initiate the liquid. Initiation delays decreased as P_0 increased; delays were 350, 10 & ~ 0 μ sec for P_0 of 2, 12 & 24 atm. For 4:1 by vol TNM/benz initiation of the liquid was observed for $P_0 > 0.7$ atm. At $P_0 \sim 0.7$ atm the initiation delay for this liquid mixture was ~ 70 μ sec

Initiation by Heat. See *Thermal Explosion and Ignition & Hot Spots* in this Vol

Initiation by Hot Fragments is probably the primary initiation mechanism in the so-called *Halved Cartridge Gap Test* (see Vol 1, p XV) and in other systems in which initiation occurs by transmission across an air gap from a *donor* to an *acceptor* charge. The hot fragments are products and reacting material thrown off by the donor; see also *Detonation by Influence* in Vol 4, p 397-R

Initiation by Hot Wire is the usual method of initiation in *Electro-Explosive Devices* such as electric blasting caps, electric detonators and squibs. In general this method is only applicable to the initiation of primary explosives (unless very special conditions are used). Various aspects of *Hot-wire Initiation* are described under *Ignition* in this Vol; *Detonators, Igniters, Primers and Other Initiating Devices* in Vol 4, pp D737-742, D806-807, D846-850 & D854-856 and *Electro-Explosive Devices* in Vol 5, pp E63-68. Addit-

ional references are: 1) F. Mauger "Initiation of an Explosion by Hot Wire," ARDE Report (B) 9/60, Aug 1960 2) H.S. Leopold, ONR Symp Det (1970) p 339 3) T.J. Tucker, Proc Symp on Behavior & Utilization of Explosives in Engineering Design (1972) pp 175-179

Initiation by Heat. See *Thermal Explosion* in a future volume and *Hot Spots & Ignition* in this Vol

Initiation by Impact is described in detail in this Vol under *Impact*. Tests in which initiation may occur as a result of dropping an explosive device are described under *Drop Tests* in Vol 5, pp D1549-1554

Initiation by Influence usually called *Sympathetic Initiation*, is the initiation of an explosive charge by the detonation of a nearby charge separated from the first charge by an inert medium; see *Detonation by Influence* in Vol 4, pp 395-398 and also *Initiation by Hot Fragments & Initiation by Shock*

Initiation by Ionizing Radiation. See *Initiation by Fission Fragments*

Initiation by LASER. See *Initiation by Light* in this Vol

Initiation by Light. See *Light, Initiation by* in this Vol

Initiation by Photochemical Effects. See *Initiation by Light*

Initiation by Precursor is a phenomenon encountered in low velocity detonations, LVD, in liquid explosives. It depends primarily on cavitation of the liquid by the shock traveling in the container ahead of the shock in the liquid. For a description of this effect, see *Low Velocity Detonation* in this Vol

Initiation by Primers (and Boosters) is the standard method of initiating secondary explosives. Thus *hot wires* (or other means) are used to initiate the primer charge (Lead Azide, Mercuric Fulminate etc) explosive whose detonation then initiates the *main charge* of PETN,

RDX etc. For "insensitive" explosives such as TNT, ANFO etc an intermediate *booster charge* (PETN, RDX, Tetryl, NG Dynamites etc) may be necessary between the primer charge and the main charge. For details, see *Minimum Priming Charges* in Vol 8; *Booster* in Vol 2, pp 243-246; *Contact Detonation Sensitivity Test* in Vol 4, pp D186-190; and the added reference of C. H. Johansson & T. Sjölin, ONR SympDet (1965) p 435

Initiation by Projectile Impact is a complicated process which depends on a combination of shock initiation, impact initiation and hot fragment initiation effects. For fast projectile impact, shock initiation effects are predominant. With slow projectiles the initiation resembles *Impact Initiation*. Further complications are introduced if the impacting projectiles are hot; a special case where the explosive is part of the projectile is the so-called Susan Test—see *Barrier Tests & Their Comparison with Shooting Tests* in Vol 4, pp D145-147 and *Detonation (and Explosion) Experimental Procedures* in Vol 4, pp 333-335

Initiation by Radio Frequency (RF) Radiation. RF radiation, ie, radio wave & radar transmitters can, under certain circumstances, initiate electro-explosive devices. This topic will be discussed under *Radio Frequency Radiation, Effects on Explosives*. Also see articles on *Electromagnetic Compatibility & Electromagnetic Field Hazard, Simulated* in Vol 5, pp E70-71 and *Electric Blasting Caps and RF Energy* in Vol 5, p E25-L

Initiation by Shock will be described in detail under *Shock Sensitivity*. Some of the tests for determining the shock sensitivity of explosives have already been given under *Detonation (and Explosion) Experimental Procedures* in Vol 4, pp D318-321, pp D322-331 & D344. Some preliminary discussion of shock initiation is also given in Vol 4, pp D520-522

Initiation by Sparks. Primary explosives, Black Powder & possibly some dynamites can be initiated by sparks of a non-electrical nature such as those caused by metal-on-stone friction etc. Manufacturers of dynamite use non-sparking tools in their plants. This is probably

a carry-over from the days when Black Powder was an important commercial explosive. Initiation by non-electric sparks is obviously a special case of initiation by heat

Initiation, Spontaneous. This is really a misnomer. What it refers to is the self-heating of an explosive as a result of autocatalytic decomposition eventually leading to a thermal explosion. "Spontaneous" initiation may also occur during crystal growth eg in Lead Azide; see *Detonation (and Explosion), Spontaneous* in Vol 4, pp D561-563

Written by J. ROTH

Innesco. Some Italian percussion fuses of WWII consisted of two parts—the "spoletta" and the "innesco." The innesco was a detonator holder without which the fuse could not operate

Ref: Ordnance Sergeant, August 1943

Inorganic High Energy Oxidizers. Title of a book by E. W. Lawless & I. C. Smith, published by Decker, NY (1968) and of the paper by W. E. Batty in *ChemInd* (London) **1969** (35), 1231-33; CA **72**, 12354/w (1970). The paper is review of the book which emphasizes F-containing oxidizers

INOSITOL AND DERIVATIVES

Inositol or Hexahydrohexamethylene. 1,2,3,4,5,6-Cyclohexanehexol, Mesoinositol (Inosite, Cyclohexanehexanol); $C_6H_6(OH)_6$, mw 180.16, d 1.524 at 15°/4° for the dihydrate, 1.752 anhydrous, mp (anh) 200-225°. White crystals, usually obtained from seeds of various plants, such as barley, peas and beans. Soluble in w, insol in abs alc & eth

It is a cyclic hexahydric alcohol, which is optically inactive. Exists also in two optical modifications:

d-Inositol: mp 247°. Colorless crystals; may be prep'd by heating its monomethyl ether, *pinite*, $C_6H_6(OH)_5(OCH_3)$ [described in Beilstein, **6**, 1193 & (587)] with hydriodic acid. Pinite occurs in resins and leaves of numerous plants, for example, senna leaves and the Madagascar rubber plant

l-Inositol: mp 238°. Colorless crystals; may be prep'd by heating 75 parts of its monomethyl

ether, *quebrachitol*, with 100 parts of hydriodic acid (d 1.70), placing the mixture in a long-neck flask provided with a tube for conducting gas away. After one hour of heating at 130-140° the temperature is raised to about 150° and heating is continued for an additional 3 hours. The mixture is then poured into a beaker and allowed to crystallize. The crystals are ground, washed with alcohol and ether, dissolved in water and filtered through activated charcoal and concentrated to a syrupy consistency. A mixture of alcohol 90% and ether 10% is then added in order to precipitate inositol. The resulting crystals are washed with alcohol and ether and dried. W. deC. Crater proposed nitrating the optically active inositols in order to prepare the explosive hexanitrate (see below)

Refs: 1) Beil **6**, 1192-6, (587-8) & [1157-9]

2) W. deC. Crater, USP 1850225 & CA **26**, 2867 (1932) 3) A. Pérez Ara (1945), p 345

4) Hackh's Chem Dict (1944), p 442

Inositol Hexanitrate (IH), $C_6H_6(ONO_2)_6$, mw 450.16, N 18.67%, OB to $CO_2 + 10.7%$, d 1.41 pressed at 3,000 psi; mp 120-122° (dec), bp ignites at 195°. Colorless plates or prisms (from hot alcohol). May be prep'd by nitrating water-free inositol with a mixture of 1 vol conc HNO_3 and 2 vols of conc H_2SO_4 . The resulting crude hexanitrate is dissolved in boiling alcohol and crystallized on cooling. The inositol trinitrate, which is formed as a by-product of nitration, remains in alcoholic solution and does not contaminate the hexanitrate. IH is insol in water; v sol in methanol and ethanol, acetone, ether and conc H_2SO_4

It is an explosive, comparable in impact sensitivity to MF and more brisant than tetryl, as determined by the sand test (52g of sand crushed compared with 47.7g for tetryl or 109% of tetryl). Its thermal stability is low (Ref 4) and for this reason is not suitable for military purposes, but can be used as a base charge in commercial blasting caps (Ref 3)

When dropped on a heated plate, IH flashes but does not explode, although it may be detonated by a commercial blasting cap

Crater (Ref 2) prepared hexanitrate of optically active d- and l-inositols by nitrating

20p of these with 100 parts of mixed nitric-sulfuric acid at about 7°(45°F). The resulting products had nitrogen contents about 18.3%, as compared with 18.67% theoretical. They are explosives with properties resembling those of inactive inositol hexanitrate. (The dextro-product is a solid, while the levo-product is a liquid). They are better gelatinizers than NG or NC and have been recommended as ingredients of double-base smokeless powder. They can also be used in dynamites or other commercial explosive mixtures in combination with NG or aromatic nitrocompounds. Crater has also claimed the use of IH in non-headache dynamites (Ref 5)

The same inventor proposed to nitrate a mixture of 20p inositol and 80p of glycerin with the same mixed acid as used for nitrating glycerin. The resulting product is fairly stable, giving a 12-minute KI test at 82.2°; nitrogen content 18.4% (Ref 2)

An interesting property of IH is that it can be detonated by the flash of a match-head (eg Ba-nitrate/Mg powder/Pb-hypophosphite). Because of this Crater (Ref 3) patented its use as a base charge in electric blasting caps containing either a MF/KClO₃ initiating charge or a match-head. It can also be used in fuse-type blasting caps if a match-type ignition composition is placed over a prepd charge of IH (Ref 3)

Ficherouille & Kovache (Ref 6) propose a method of preparing IH that is essentially similar to the one described above. They do, however, suggest the addition of 85p of lactose to 15p of wet IH before drying as they consider the drying of pure IH (without 85 of inert material) to be dangerous

They find IH to be more impact-sensitive than **Hexamethylenetriperoxydiamine** and very sensitive to friction. IH explodes violently when placed on a sheet of paper when one of the corners of the paper is ignited and its flame reaches the IH

Refs: 1) Beil 6, 1197 2) W. deC. Crater, USP 1850225 & CA 26, 2867 (1932) 3) Ibid, USP 1951595 & CA 28, 3590 (1934) 4) J.D. Hopper, PATR 857 (1937) "Investigation of IH as a Military Explosive" 5) W. deC. Crater, USP 2340304 (1944) & CA 38, 4134 (1944) 6) H. Ficherouille & A. Kovache, MP 32, 133 (1950) & CA 48, 4454 (1954) 7) Nothing pertinent found in CA 1957-1971

Inspection of Ammunition and of Explosives.

The process of examination of explosives etc, usually of a visual, physical, chemical or ballistic nature are performed by specially assigned persons, called Inspectors. The idea of this inspection is to determine the quality of the product from the point of view of the specifications pertaining to it

Inspections may be divided into Initial, and Periodic or Subsequent Inspections

For more info regarding regulations & procedures connected with the inspection and testing of expls for the Government, see the following Refs

Refs: 1) Anon, "Ammunition Inspection Guide, War Dept Tech Manual **TM9-1904** (1944), 940 pp 2) Dept of Defense Military Standard, "Explosive: Sampling, Inspection and Testing", **MIL-STD-650** (Aug 1962) 3) Dept of Defense Military Standard, "Pyrotechnics: Sampling, Inspection and Testing", **MIL-STD-1234** (March 1967) 4) Dept of Defense Military Standard, "Propellants, Solid: Sampling, Examination and Testing", **MIL-STD-286B** (Dec 1967) & Notice 2 (June 1971) 5) US Army Materiel Command Regulation, "Safety Manual", **AMCR 385-100** (April 1970), p 26-3 (High Explosives)

Instantaneous Fuse. This fuse, burning at the rate of 100 to 300 feet per second, was formerly much used in blasting operations where a number of charges had to be fired "simultaneously." It has now been replaced by detonating fuses and electric detonators

Instantaneous fuse was made by wrapping several strands of quick match in waterproof tape. The fuse was fired by means of a percussion cap in a special pistol

The term is sometimes erroneously applied to Cordeau Détonant or Primacord

Ref: Marshall 2 (1917) p 540

Instantaneous Photography. See *High-Speed Photography* in this Vol and *Cameras, High-Speed Photographic* in Vol 2, pp C13-19

Instrumentation and Instrumental Methods of Analysis (see also next topic). The principle purposes of instrumentation in the chemical industry are to measure and control physical changes and chemical reactions. Instrumental methods of analysis concern the application of

various instruments to the solution of specific problems of analytical chemistry. Under the title come spectroscopy, polarography, X-rays, photometry, superionics, various electronic devices, such as oscillographs etc

Each of these subjects is mentioned under separate headings. References on instrumentation run into the thousands. In the opinion of Dr. R. H. Müller, there should be a distinct subject known as *analytical instrumentation*, which should be concerned with a study of all known physical phenomenon for their possible use in analytical chemistry. General references on this subject are given below

Refs: 1) M. F. Behar, *Manual of Instrumentation*, Instrument Publishing Co, Pittsburgh (1932) 2) R. H. Müller, *IEC (Anal Ed)*, **11**, (1939) (Review on photoelectric methods in chemical analysis, including 239 refs) 2a) R. H. Müller, *Ibid*, **13**, 667-754 (1942) (A review on instrumental methods of analysis) (313 refs) 3) L.A. McColl, *Fundamental Theory of Servomechanisms*, Van Nostrand, NY (1945) 4) D.P. Eckman, *Principles of Industrial Process Control*, J Wiley, NY (1945) 5) H.W. Bode, *Network Analysis and Feedback Amplifier Design*, Van Nostrand, NY (1945) 6) Greenwood and Collaborators, "Electronic Instruments," vol **21**, MIT Radiation Laboratory Series, McGraw Hill, NY (1948) 7) R.H. Müller, *AnalChem* **20**, 389 (1948) (*Instrumental methods of analysis*) 8) R.H. Müller & J.J. Lingame, *AnalChem* **20**, 795 (1948) 9) A.L. Chaplin, *Instruments* **21**, 532-40 (1948) 10) H.M. Schmitt, *Automatic Chemical Process Control*, Minneapolis-Honeywell Regulator Co, Phila (1949) 11) R.H. Müller, *AnalChem* **21**, 108-115 (1949) (*Instrumentation*; 12 refs are included) 12) A. Camp & L. Slater, *ChemEng* **57**, No 9, 108-111 (1950) 13) D.M. Considine & S.D. Ross, *Chem Engrg Prog* **46**, 518-22 (1950) 14) D.A. Smith & J. Procopi, *Instrumentation* **4**, 32-34 (1950) 15) J.A. Parker, *Instrumentation* **5**, 4-7 (1950) 16) R. Rosenthal, *Instruments* **23**, 664-69 (1950) 17) E.F. Pollard et al, *IEC* **42**, 748-52 (1950) 18) M.F. Behar, Ed, *The Handbook of Measurement and Control*, The Instrument Pub Co, Pittsburgh (1951) 19) R.E. Kirk & D.F. Othmer, Eds, *Encyclopedia of Chemical Technology*, Interscience, NY, v **7** (1951) pp 908-926; J-Procopi, *Instrumentation* (11 refs) 20) R.H. Müller, *Analytical Chemistry*, "Instrumentation"; Short

article, each month 21) H.H. Willard et al, *Instrumental Methods of Analysis*, Van Nostrand, NY (1951) 22) D.F. Boltz, *Selected Topics in Modern Instrumental Analysis*, Prentice Hall, NY (1952) 23) W.G. Holzbock, *Instruments for Measurements and Control*, Reinhold, NY (1955) 24) E.B. Pierson, *Technology of Instrumentation*, Van Nostrand, Princeton, NJ (1957) 25) P. Delahay, *Instrumental Analysis*, Macmillan, NY (1957) 26) H.H. Willard et al, *Instrumental Methods of Analysis*, Van Nostrand, NY (1958)

Instrumentation for Studying Explosives. See under individual items, eg, *Cameras*, *High-Speed* in Vol **2**, pp C13-19; *Chronographs* in Vol **3**, pp C305-319; *Impact Machines* under *Impact* in this Vol; *Pressure Transducers* in a future Vol etc. Three good general references on this subject are:

1) *NOLR 1111* (1952), Chapt 9 2) Cook (1958) pp 22-43 3) *AMCP 706-180*, Chapt 5

Intensive Incendiary Agent (See also *Incendiary Warfare* in this Vol) is one that is merely ignited (not detonated) and burns in one compact mass

Ordinary thermite and magnesium belong to this class. They burn long and intensively but their action is confined to a small area. This is sometimes preferred when dealing with objects of low combustibility. The disadvantage of intensive agents lies in the fact that when they fall on objects which are not ignitable, no damage is done even if ignitable objects are located only a few feet away

Ref: G.J. Fisher, "Incendiary Warfare," p 32, McGraw Hill (1946)

Interferometers, Applications to the Study of Explosion and Propulsion Phenomena. Two monochromatic light beams arriving out-of-phase at some surface will produce a "fringe" illumination pattern on that surface. This phenomenon is called *interference*. If the light beams are in phase the illumination intensity is the sum of the individual intensities, but if they are half-a-wavelength out of phase, the illumination intensity decreases and becomes zero if the individual light beams are of equal intensity. In-between there are gradations

of reinforcement and cancellation depending on how much the two light beams are out-of-phase (Ref 15)

Interferometers are instruments for measuring displacement (distance) by utilizing light interference phenomena. We will illustrate the operation of interferometers by describing a method of measuring the velocity of a specimen (with a reflecting surface), propelled by a detonating explosive charge (free-surface velocity), by using a *Laser Interferometer*

A laser interferometer is shown schematically in Fig 1. The parameter measured is the free surface velocity of the specimen material. The principle of operation is as follows. Light from the single frequency gas laser is focused on the

surface of the target by means of a lens L1. The reflected light is recollimated by L2, and then split by a beam splitter B1. Half the light traverses the delay leg and is recombined with the undelayed half at beam splitter B2. The photomultiplier then records a signal whose brightness depends on the relative phases of the two beams. Since the delay leg is fixed and the wavelength of the input light is a function of free surface velocity (Doppler shift), the number of fringes recorded at the photomultiplier is related to the free surface velocity. The relationship can be derived as follows (Ref 17). The Doppler shift is given by

$$\Delta\lambda(t) = -\left(\frac{2\lambda}{c}\right)u(t) \quad (1)$$

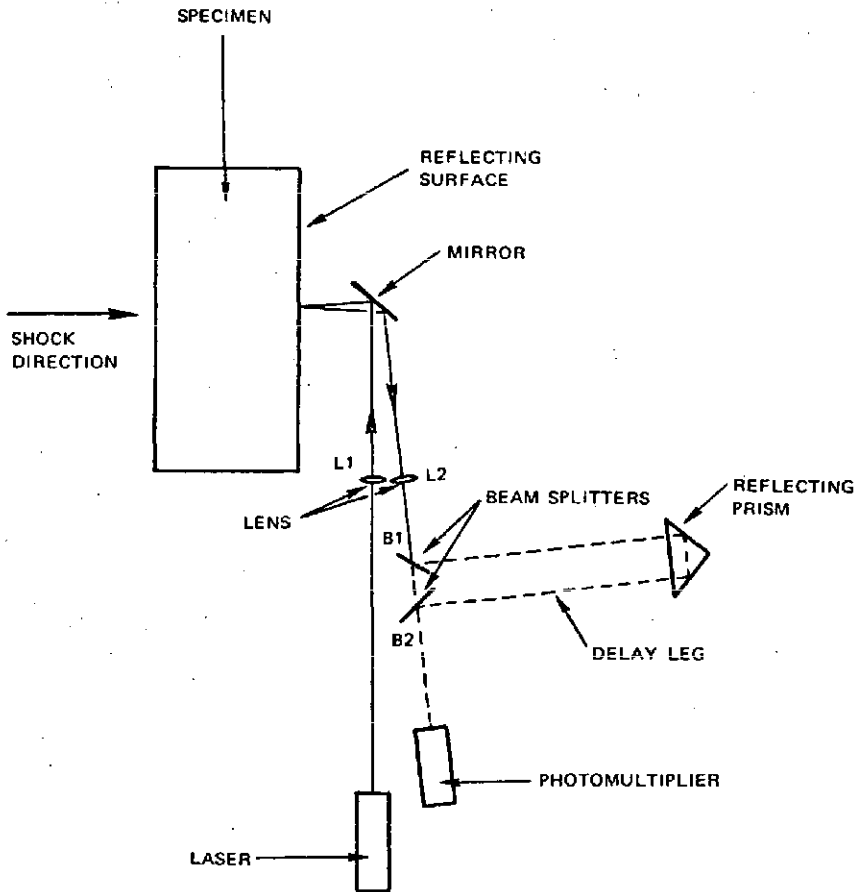

Fig 1. Laser Interferometer System (The velocity of the reflecting surface is related to the number of fringes observed by the photomultiplier)

where λ is the laser wavelength, c the speed of light, and $u(t)$ is the speed of the reflecting surface at time t . The delay lag length $N\lambda$ is

$$N\lambda = c\tau \quad (2)$$

where τ is the time for light to traverse the delay leg. Differentiating Eq (2) gives

$$\Delta N(t) = -\left(\frac{c\tau}{\lambda^2}\right) \Delta\lambda(t) \quad (3)$$

and substituting for $\Delta\lambda$ in Eq (1) from Eq (3) gives

$$u(t) = \left(\frac{\lambda}{2\tau}\right) \Delta N(t) \quad (4)$$

The number of fringes ΔN as a function of time are thus related to the reflecting surfaces velocity by a constant $\lambda/(2\tau)$

The major advantages of the laser interferometer over previous free surface systems are the high time resolution and the high surface velocity capability. The limitations in rise time are limited by the capability of the photomultiplier or oscilloscope recording system. The bandwidth of each system is typically 600 MHz or a response time of ≈ 1 nsec (Ref 13)

Many other interferometers have been described in the literature (see references). Among these are the Fresnel, Fabry & Pérot, Jamin, Rayleigh, Michelson and Mach-Zehnder interferometers. Some application of interferometers are given below

E. Mach and his son L. Mach were the first to apply an interferometer to ballistics (Refs 3 & 4). They modified the Jamin Interferometer and used it to determine the densities of air near a projectile. A schematic arrangement of their apparatus is given in Ref 4, p 274, fig 105 and in Ref 10, p 1360. Zehnder (Ref 2) modified Mach's apparatus and the so-called *Mach-Zehnder* apparatus is still used

Bergdoit (Ref 12) used the Mach-Zehnder interferometer and a short duration light source with a rotating mirror camera to obtain interferograms of projectiles and the air flow patterns around them

Ladenburg et al (Ref 10) described the application of the interferometer techniques to the study of faster than sound phenomena. Weimer et al (Ref 11) applied these techniques

to the study of shock waves. Bennett et al (Ref 15) gave the theory of interferometric analysis and described the procedure used by them at Ballistic Research Laboratories, Aberdeen Proving Ground, to study air flow around projectiles in free flight

Bundy et al (Ref 13) measured the velocity and pressure of gases in a rocket flame by determining the small shift in wavelengths of the flame luminosity with a Fabry-Perót interferometer

Refs: 1) E. Mach & L. Mach, Wien Akad Ber (Math-Phys Klasse) **98**, 1318 (1889) 2) L. Zehnder, Zeits f Instrumentenkunde **11**, 275 (1891) 3) L. Mach, Zeits f Instrumentenkunde **12**, 89 (1892) & **14**, 279 (1894) 4) C. Cranz, Lehrbuch der Ballistik, J. Springer, Berlin, v 3, (1927) pp 271-279; Ergänzungsband (1936) pp 173-175 5) H. Schardin, Zeits f Instrumentenkunde **53**, 396 (1933) 5a) M. Tesson, Etude G B Note No 2 (15 April 1940); Service technique des fabrication d'armement, Section ballistique extérieure (Paris, France) 6) W. Kinder, Optik **1**, 413 (1946) 7) J. Winckler et al, Phys Rev **69**, 251 (1946) 8) R. Ladenburg, Phys Rev **71**, 464 (1947) 9) J. Winckler, RevSciInstr **19**, 307 (1948) 10) R. Ladenburg et al, PhysRev **73**, 1359-1377 (1948) 11) D.K. Weimer et al, JApplPhys **20**, 418 (1949) 12) V.E. Bergdoit et al, PhysRev **76**, 879 (1949) 13) F.P. Bundy et al, JAppl Phys **22**, 1069-1077 (1951) 14) C. Candler, Modern Interferometers, Hilger & Watts Ltd, London (1951) 15) F.D. Bennett et al, JAppl Phys **23**, 453-469 (1952) 15a) G.D. Kahl & F.D. Bennett, JApplPhys **23**, 763-767 (1952) 16) F.A. Jenkins & H.E. White, "Fundamentals of Optics," McGraw Hill (1957) 17) L.M. Barker "Fine Structure of Compressive and Release Wave Shapes in Aluminum Measured by the Velocity Interferometer Technique," Symp on High Dynamic Pressure, Paris (1967) 18) AMCP 706-180, pp 5-16 to 5-17

Interior Ballistics. See *Ballistics* in Vol 2, p B7

Intermittent Detonator Devices. An analytical & experimental investigation was conducted to determine the operating characteristics of an intermittent-combustion device employing gaseous detonative combustion. Gaseous propane & air

were used as propellants in the experimental investigation

Results indicated that the intermittent-detonation device was capable of operating on at least two "resonant" spark-energization frequencies – approx 20 & 50 cps. Reaction thrust, noise output, and actual combustion frequency were noticeably greater at resonant conditions than at other operating points

Reloading of the tube with fresh charge occupied most of the cycle time, which limited the operating frequency of the device. This intermittent-detonation device – which consisted of three assemblies: air manifold, fuel injector, and detonation tube – did not appear promising as a thrust producing mechanism because of its low operating frequencies

It was recommended that the investigation of intermittent-detonative combustion should be continued to determine the conditions under which resonant operation occurs. Also the effects of varying the physical characteristics of the detonation device should be determined experimentally

Ref: L.J. Krzycki, "Performance Characteristics of an Intermittent-Detonation Device", **NAVWEPS Rept 7655**, US Ordnance Test Station, China Lake, Calif (June 1962)

Intermittent Illumination. See *Cameras, High Speed* in Vol 2, pp C13-19 & *High-Speed Photography* in this Vol

Internal Ballistics of Barrel Weapons and of Solid Propellant Rockets (Vnutrenniya Ballistika Stvol'nykh Sistem i Porokhovykh Rakët). Title of the book by M. E. Serebriakov, GosNauch – TekhizdatOboronghiz, Moskva (1962), 3rd edition, 703 pp

Internal Energy is the energy contained within a system. It is an extensive property of the system and the increase or decrease in internal energy between two states is independent of the way the change between states is brought about

The First Law of Thermodynamics is usually written in the form $dE = TdS - PdV$ where E, the internal energy, S, the entropy, and V, the volume, are extensive properties of the system, and P, the pressure, and T, the temperature, are

intensive properties of the system. Extensive properties depend on the mass of the system while intensive properties are independent of mass

The internal energy, or rather the change in internal energy is an important variable in *Hydrodynamics*. It occurs in the Rankine-Hugoniot (RH) equation (Vol 4, p D531-R, Eq 8 or p D605-L, Eq 13) and as parameter in various equations of state for detonation products (eg see Vol 4, pp D285-287 or pp D294-295 or p D275)

International Committee Tests. The tests designed by the International Committee for blasting explosives are as follows:

1) *Preliminary Test.* Same as International 75° Test, as described under *Physical Tests* in Vol 1, p XVIII

2) *Falling Weight (Impact) Test.* Ten tests with 0.05 to 0.10g samples, using an apparatus having an anvil 1.27cm(0.5") in diameter, should show that the explosive is less sensitive than Picric Acid (PA)

3) *Friction Test.* A small sample of explosive rubbed in an unglazed porcelain mortar should not show greater sensitivity than PA at room temp

4) *Sensitiveness to Ignition.* The same tests are applied as given under *Ignition Tests* in this Vol. These include: Fuse Test, Red Hot Iron Basin Test, and Red Hot Iron Test

Ref: Marshall (1917), 2, p 437

International Heat Test. See *Physical Tests* in Vol 1, p XVIII

International Regulations. Following is a list of International Regulations and where they may be purchased:

"The International Carriage of Dangerous Goods by Road (ADR)"

"The International Regulations Concerning the Carriage of Dangerous Goods by Rail (RID)" (approx \$6 each)

From: *Her Majesty's Stationary Office, 49 High Holborn, London, WC 1, England*

"International Maritime Dangerous Goods Code", Volumes I, II, and III [approx \$25 per set, Sales No IMCO 1972.9 (E)]

From: *Inter-Governmental Maritime Consulta-*

tive Organization, 101-104 Piccadilly, London, W1V OAE, England

"IATA Restricted Articles Regulations", 16th Edition, (\$6 per copy)

From: *International Air Transport Association, PO Box 315, 1215 Geneva 15 Airport, Switzerland*

"Transport of Dangerous Goods", Volumes I, II, III, and IV (\$7.25 per set)

From: *United Nations, Sales Section, New York, NY 10017, OHM Newsletter, Vol III, No 4, July 1973, Department of Transportation, Office of the Secretary, Washington, DC 20590*
Ref: G. Cohn, *Expls & Pyrots* 7 (1), 1974

Interrupter Burner Test. In studying the effects of burning surface, grain consolidation, inhibitor effectiveness, etc on the intermediate stages of propellant combustion, it is frequently desirable to interrupt the burning process. The Interrupter Burner is a cylindrical combustion chamber with a firing plug at one end and a rupture disc at the other end. The rupture disc is designed to rupture at some pre-selected pressure generated by the burning propellant test sample. This sudden release of pressure extinguishes ("interrupts") the burning of the test sample
Ref: C. deFranco, *PicArnsn Testing Manual* No 2-3 (1951)

Interstate Commerce Commission (ICC) Regulations. The transportation of explosives and other dangerous articles in interstate commerce within the limits and jurisdiction of the United States, is regulated by Federal Law, Act of March 4, 1909, Chapter 321, Sect 232 and 234 (35S 1134) as amended by the Act of March 4, 1921, Chapter 172 (41S 1444-1445)

Violations of this Act are punishable by severe fines and imprisonment

Under authority of the Act quoted above, the ICC has published regulations which can be obtained from them by writing to Dept of Commerce, ICC, Washington, DC

Note: In addition to the regulations issued by the ICC, the regulations of the Bureau of Explosives (for rail shipments) as well as various harbor, state, municipal regulations should also be consulted. This complicates the situation, as the various States, municipalities etc pass laws that apply to the particular location, but there are no universal laws governing the handling,

storage etc of explosives etc. For a summary of labeling and shipping regulations for explosives, see Sax "Dangerous Properties of Industrial Materials," 3rd Edit (1968), pp 309-362

Intraplant Distances. All explosive operating buildings and service magazines must be separated in conformity with the so-called "intraplant quantity-distance tables." If the hazards involved require dividing an operating line into separate buildings, such hazards are great enough to require the use of full intraplant distances between buildings unless effective separate barricades are provided, in which case these distances may be halved

Each state has its own regulations regarding distances. For instance, the table on p 810 of TM 9-1904, gives the "Intraplant Quantity-Distance Table" as prescribed by New Jersey State laws

Intrinsic Pressure. See under *Detonation (and Explosion), Equations of State, Introduction* in Vol 4, p D269-L

Inulin (Alant Starch, Dahlin, Alantin). $(C_6H_{10}O_5)_6$ H_2O , mw 990.86. White, hygroscopic powder or horny amorphous lumps; mp 178° (decomposes beginning at 160°), d 1.35-1.4 at 20°/4°. Sl sol in cold w, sol in hot w; sl sol in alc. May be obtained from the bulbs of *Dahlia variabilis* or other plants. On nitration, it gives an explosive compound
Refs: 1) Beil, not found 2) Fieser & Fieser, "Org Chem," Heath & Co, Boston (1950) p 406 3) *CondChemDict*, 8th Edit (1971), p 471

Inulin Trinitrate. $[C_6H_7O_2(ONO_2)_3]_n$, mw $(297.14)_n$, N 14.14%, OB to CO_2 -24.2%; colorless, amorphous solid; mp softens at 90° and melts at 102°, bp decomposes beginning about 110°. When heated rapidly, it ignites without exploding at 228-230°. First prepd by the nitration of inulin with mixed nitric-sulfuric acid by W. deC. Crater of Hercules Powder Co

When mixed acid contg 48.50% HNO_3 and 51.20% H_2SO_4 is used the resulting nitrate contains about 13.75%N, while nitration with MA contg 20.8% HNO_3 and 62.8% H_2SO_4 gives a 12.80%N

product

Inulin nitrate is insol in w, eth, ethyl and methyl alc, toluene and carbon tetrachloride, but dissolves in acetone, ether & alc mixt, concd H_2SO_4 , ethyl acetate etc. It does not crystallize from solutions but forms a film

Inulin nitrate is compatible with NC, nitrostararch etc

It is a fairly stable explosive, having an impact sensitivity of about 30cm with a 2kg weight

Inulin nitrate was proposed as a base charge in blasting caps, as a sensitizer for ammonium nitrate in dynamites and as an ingredient of smokeless powders

W. deC. Crater gives the following examples of explosives using inulin nitrate primarily as a sensitizer:

Ammonium nitrate dynamite. NH_4NO_3 65, Inulin nitrate (13.75%N) 20, $NaNO_3$ 11, Pulp (such as wood pulp) 4. This dynamite has a rate of detonation of 2310 m/sec, weight per 1¼ stick - 120g; cartridge cont 378 per 100 lb; sensitiveness (gap test) 4"; weight strength 53.5%. It flows and packs easily, is not dusty, does not freeze and does not cause headaches

Base charge. A standard blasting cap shell may be charged with .16g of nitroinulin (13.75%N) pressed under 7840 psi, and provided with a primer charge of 0.3g of 80/20 fulminate-K chlorate mixt. Such a cap was found to be satisfactory for the detonation of explosives

Ref: 1) W. deC. Crater, USP 1992123 (1933) & CA 27, 5190 (1933) 2) No further refs found in CA 1947-1971

Iodamide. NI_3 ; see Nitrogen Iodide under *Iodides* in this Vol

IODATED AND NITRATED PARAFFINS

Some paraffin compounds containing both I and NO_2 groups are explosive, for example:

Iododinitromethane. $CHI(NO_2)_2$; mw 231.96, N 12.07%

Its **potassium salt**, $KCI(NO_2)_2$, mp (explodes violently at 154°); orange-yellow plates. It was first prepd by Villiers (Ref 2). Gotts & Hunter (Ref 4) dissolved 10g of K dinitromethane in 300ml of water containing 4g of KOH (one equivalent), cooled the solution and slowly added powdered iodine (18g) to it with shaking. The solution was evaporated to a small bulk (50ml), which caused the separation of about

163g of crystals. These were dissolved in hot water and then cooled—the pure salt crystallized out

The salt is nearly insol in cold water; sol in hot w. It is a violent explosive

Its **silver salt**, $AgCl(NO_2)_2$, mp (explodes at $109-110^\circ$). Pale yellow glistening leaflets; may be prepd by the action of $AgNO_3$ on an aqueous solution of potassium iododinitromethane. Insol in w (Ref 4)

Di-iododinitromethane. $I_2C(NO_2)_2$; dark-colored, pungent smelling oil. Was obtained on acidifying an ice cold solution of potassium iodonitromethane. It could not be properly examined because it decomposed immediately with the evolution of gas and iodine (Ref 4)

Iodotrinitromethane (Sometimes erroneously called Iodopicrin), $CI(NO_2)_3$, mw 276.95, N 15.17%, OB to CO_2 & I_2 +23.1%, mp $55-58^\circ$, bp 48° at 13mm. Bright yellow leaflets; may be prepd by the action of an ethereal solution of iodine on the silver salt of nitroform

It decomp on storage (Ref 1). Its hydrolysis const is 4×10^{-7} (Ref 5). Insol in w; sol in hot bz, ligroin and alc. No mention of any explosive properties (Refs 1, 3 & 5)

No further mention of explosive props of *iodonitromethanes* were found in the CA Formula Indices 1920-1971

Some interesting work on the decomposition kinetics of $IC(NO_2)_3$ has been reported. In the gas phase this compd decomposes with homogeneous first order kinetics over the temp range of $100-160^\circ$ (Ref 6). The activation energy obtained ($E = 34.4$ kcal/mole, $\log Z = 15.25$) suggests that the primary step is the rupture of the C-N bond followed by a radical (non-chain) reaction (Ref 7). Addn of a large excess of NO, one of the decompn products, increased reaction rate 20-30%, addn of a large excess of NO_2 , another decompn product, lowered the reaction rate 10%. Addn of I_2 , also a decompn product, had no effect on rate (Ref 7)

The strength of the C-I bond is claimed to be 34.8 kcal/mole (Ref 7)

Mass spectrometric studies fully confirmed the previous manometric studies quoted above (Ref 8). In the liq phase the pyrolysis of $IC(NO_2)_3$ at $80-140^\circ$ has the same kinetic as in the gas phase. Replacing a NO_2 group with

F stabilizes the molecule. Thus the kinetic parameters for the decompn of $\text{IC}(\text{NO}_2)_2$ are $E = 39.7$ kcal/mole & $\log Z = 15.7$ over the range $170\text{--}214^\circ$ (Refs 9 & 10)

Mass spectra of positive and negative ions of $\text{IC}(\text{NO}_2)_3$ have been obtained (Ref 11)
 Refs: 1) Beil 1, 79, [45] & [47] 2) Villiers, BullSocChim 43, 332 (1885) 3) A.K. Macbeth & D.D. Pratt, JCS 119, 357 (1921) & CA 15, 1669 (1921) 4) R.A. Gotts & L. Hunter, JChemSoc 125, 442 (1924) & CA 18, 1270 (1924) 5) L. Birckenbach et al, Ber, 62, 206 (1929) & CA 24, 1311 (1929) 6) G.M. Nazin et al, Combust Flame 12 (2) 102 (1968) & CA 69, 4102 (1968) 7) G.M. Nazin et al, DoklAkadNauk 177 (6), 1387 (1967) & CA 69, 26568 (1968) 8) G.M. Nazin et al, IzvAkadNauk, SerKhim (1968) 315 & CA 69, 66758 (1968) 9) G.M. Nazin, Ibid, (1968) 2628 & CA 70, 6738 (1969) 10) G.M. Nazin, Ibid (1968) 2801 & CA 70, 77061 (1969) 11) J.T. Larkins et al, OrgMassSpectrum 5 (3), 265 (1971) & CA 75, 12076 (1971)

Iodates and Periodates. Many inorganic iodates & periodates are known. Although many iodates & periodates are thermally unstable only the ammonium salts appear to be explosive. However iodates and periodates are powerful oxidizing agents and can react vigorously with many reducing agents (Ref 5)

Varhelyi & Kekedy studied the thermal decomposition of iodates & periodates by thermogravimetric methods (Ref 2). They found that there is no similarity in the decomposition of univalent iodates, but most divalent iodates decompose similarly since their decomp temps are similar. The thermal stability (ie their resistance to decomposition into iodates) increases as follows: of the alkali periodates $\text{Li} < \text{Na} < \text{K} < \text{Rb} < \text{Cs}$. The thermal stability of alkaline earth periodates increases in the order $\text{Ca} < \text{Sr} < \text{Ba}$

Ammonium Iodate. NH_4IO_3 ; mw 192.96, N 7.25%, rhombic or monoclinic crystals, d 3.31; sol in w; decomposes on heating

Solymosi et al (Ref 3) studied the thermal decomp & explosion of Ammonium Iodate. They found that the decomposition of ammonium iodate starts at 140°C . The reaction yielded a solid reaction product which according

to analysis, consisted of iodine pentoxide. In the gas phase, iodine, oxygen, nitrogen and nitrogen oxide were found. The reaction occurred without time lag. The course of the curve and the kinetics were independent of whether the reaction was followed by the pressure of the gases formed or by the change in weight of the sample. The decomposition was described, by the unimolecular decay equation from the beginning of the reaction to 85% completion. The value of the activation energy was 66.4 kcal

Explosion of ammonium iodate took place at a temperature of 185°C , ie, very much higher than for the other halates (81°C for NH_4BrO_3 & 90° for NH_4ClO_3). The explosion was preceded by a readily measurable and gradually accelerating decomposition. Contrary to the two other halates, self-heating was not observed before the explosion. The explosion was accompanied by a violet colored flash and produced a temperature increase of only 10°C in the reaction zone. The activation energy of the process leading to explosion was 38.4 kcal

From these measurements it appears that the stability of the compounds does not follow the expected order of chlorate < bromate < iodate. This behavior, however, cannot be regarded to be a characteristic property of ammonium halogenates only, because according to our experiments the same order of stability has been found in case of potassium halates. It is fairly difficult to propose a reliable reaction mechanism merely from kinetic data

Solymosi et al suggest that the rate-controlling step in the thermal explosion of NH_4IO_3 is the rupture of an I—O bond

They also make the statement (no data or refs) that ammonium halates ($-\text{ClO}_3$, $-\text{BrO}_3$ & $-\text{IO}_3$) are impact & friction sensitive. This is in line with the thermochemical calculations and conclusions therefrom made by Shidlovskii (Ref 4) for both NH_4IO_3 & NH_4IO_4

Ammonium Periodate. NH_4IO_4 ; mw 208.96, N 6.7%; tetrag colorless crystals, d 3.06, sol in w. Decomposes on heating

Solymosi et al (Ref 2) imply that NH_4IO_4 is more stable than NH_4IO_3 . However a serious explosion occurred when NH_4IO_4 was scooped from one container to another (Ref 1)

Hydrazinium Iodate. $N_2H_4 \cdot HIO_3$ has been postulated to exist only in cold solutions (Ref 4). In general, hydrazinium salts of oxidizing acids are much less stable than the corresponding ammonium salts

Refs: 1) G.F. Smith, ChemEngNews **29**, 1770 (1951) & CA **46**, 3279 (1951) 2) Cs. Varhelyi & E. Kekedy, Studia UnivBabes-Bolyai (Romania) SerChem No **1**, 11 (1962) & CA **61**, 2698 (1964) 3) F. Solymosi et al, ZPhysikChem (Frankfurt) **48** (3-4), 242 (1966) (in English) & CA **65**, 1442 (1966) 4) A.A. Shidlovskii, ZhFizKhim **39** (9), 2163 (1965) & CA **64**, 516 (1966) 5) Sax (1968) p 837 6) No refs to explosive iodates or periodates found in CA 1947-1971 (other than NH_4 compds) searching under *iodates*, *periodates* & *iodic acid*

IODIDES

Most metals form iodides eg KI, PbI_2 , BiI_3 , SnI_4 etc. The iodides of the transition elements are usually in their lowest oxidation state eg FeI_2 , CoI_2 , MnI_2 , CrI_2 etc. All of these metal iodides are stable and nonexplosive

Iodine forms numerous interhalogen compds, eg IBr, ICl_3 , IF_5 etc but these are not really *iodides* since the iodine in these compds (if they are not covalent) plays the part of a "metal" ion

The only explosive iodide is *Nitrogen Iodide* which is described below

Nitrogen Iodide (also known as Nitrogen Triiodide). NI_3 ; mw 394.77, N 3.55%; black cryst, explodes on heating, sublimates in vac, insol in w, decomp in hot water (Ref 15). Prepd by treating I_2 with concd aq NH_3 , probably via

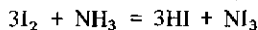

By passing NH_3 over I_2 a series of ammoniated NI_3 compds can be prepd. These lose NH_3 under vac except that the last NH_3 cannot be removed in this manner and the compd thus formed is $NI_3 \cdot NH_3$ (Refs 1, 2 & 3)

Suspensions of NI_3 in NH_3 at -78° give dark ppts with solns contg low concentrations of NH_2^- . The ppt with $AgNH_2$ is $AgNH_2 \cdot NI_3$. It is explosive when dry, but inert to excess $AgNH_2$ & stable in liq NH_3 or in H_2O at 0° . At room temp the H_2O soln decomposes (accelerated by light) to Ag , AgI , NH_3 , & N (Ref 13)

Nitrogen Iodide is an *exceedingly sensitive* explosive when dry. It explodes upon the slightest touch and also upon very mild heating such as in a warm air stream. *It must be stored wet*, preferably under ether (Ref 15). Because of its phenomenal sensitivity NI_3 is not a practical explosive, but by the same token it has been studied rather extensively to determine why it is so sensitive. Since these studies contribute to the understanding of explosion phenomena they are described below

Bowden & Yoffe (Ref 12, p 73) state: "Nitrogen iodide ($NI_3 \cdot NH_3$) is a very unstable material and will explode under the action of very weak shocks. Even at liquid air temperatures, initiation occurs at an energy of 0.6g/cm (Ref 4). The stability of nitrogen iodide under normal conditions depends to a great extent on the presence of ammonia which retards the decomposition of the pure NI_3 (Ref 8). Meerkämper (Ref 9) has found that the sensitivity to impact is also reduced in an ammonia atmosphere. Presumably the ammonia is rapidly adsorbed on the freshly exposed surface of the crystals of nitrogen iodide and prevents the decomposition from spreading"

Nitrogen Iodide & $NI_3 \cdot NH_3$ can also be decomposed and ignited by light (Refs 10 & 11). Light absorption is strong in the visible and weaker (but constant) in the IR (Ref 12, p 104)

Meerkämper (Ref 9) irradiated nitrogen iodide in low-pressure atmospheres of air or ammonia at various temperatures and determined the quantum yield of the decomposition. He finds that this value is not constant but increases to a limiting value as the irradiation is continued. This limiting value depends on the ambient temperature. The results suggest that the decomposition is mainly thermal due to the conversion of the light energy into heat. There is a small (5 to 10%) photochemical effect particularly when the nitrogen iodide is irradiated with blue or red light

When the intensity of the light from the flash-lamp is sufficiently high nitrogen iodide explodes. The amount of light energy required for ignition depends on the temperature (see Figure). Extrapolation of the curve back to zero light energy gives a value of $80^\circ C$ which should be compared with 50° which is the 'dark' ignition temperature

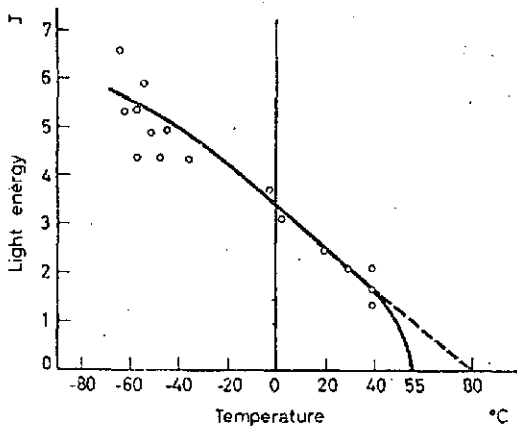

Figure. Relation between the light energy required for ignition (joule) and temperature ($^{\circ}\text{C}$) for nitrogen iodide (Ref 9)

Again quoting Bowden & Yoffe (Ref 8, pp 105-106): "The time at which the explosion occurs relative to the duration and the intensity of the light flash has been determined by means of spark photography. Meerkämper (Ref 9) finds that explosion occurs just before or at the time of maximum intensity of the light flash. This means that only a fraction of the total light energy is used for ignition. This result is similar to that observed for Silver Azide. The light energy, E , passing into the surface layer which is used for ignition is such that

$$Et = \text{const} = 1.35 \times 10^{-6} \text{ Jsec/cm}^2$$

where t is the time between the beginning of the light flash and the beginning of the explosion. For a light flash lasting $200 \mu\text{sec}$, the energy $E \approx 0.023 \text{ J/cm}^2$, and the time $t = 50 \mu\text{sec}$. This time is close to that required for the lamp to reach its maximum intensity

Nitrogen iodide also explodes when it is irradiated with light from a spark discharge in air. A glass plate placed between the spark and the nitrogen iodide sample hinders the passage of the shock wave from the spark. The duration of the spark ($4 \mu\text{F}$, 12kV) is ca $200 \mu\text{sec}$.

The light-time curve for such a spark rises very rapidly and explosion begins $6 \mu\text{sec}$ after the beginning of the light from the spark.

When the discharge is from $0.4 \mu\text{F}$ at 38 kV the time from the beginning of the spark to explosion is $4 \mu\text{sec}$

If a tube filled with Xenon is used instead of the spark in air the explosion begins $3.7 \mu\text{sec}$ after the first appearance of light. This value of $3.7 \mu\text{sec}$ means that ignition takes place ca $0.5 \mu\text{sec}$ after the flash has reached its maximum intensity. Again it is clear that only a small part of the incident light is used for igniting the nitrogen iodide

The results described above, in particular the relation between ignition energy and temperature, suggest a thermal mechanism for the initiation. The light will not be absorbed in a uniform manner in the surface layers. However, a rough estimate of the thickness of the surface layer which is heated to the ignition temperature may be obtained by assuming that the whole of the surface layer is heated to a uniform temperature. If d is the thickness of this surface layer, then

$$d = \frac{E}{A\Delta TgC}$$

where E is the energy absorbed, A the surface area of the nitrogen iodide on which the light falls, ΔT the temperature difference, g the density of the nitrogen iodide and C the specific heat. Experimentally it is found that $E/A = 8 \times 10^{-2} \text{ J/cm}^2$

Since ignition occurs in less than $50 \mu\text{sec}$ for a flash of $200 \mu\text{sec}$ duration, it is assumed that only the energy $E/3A$ is used for ignition

$$\begin{aligned} \frac{E}{3A} &\approx 2.7 \times 10^{-2} \text{ J/cm}^2 \\ &= 6.4 \times 10^{-3} \text{ cal/cm}^2 \end{aligned}$$

For an ignition temperature of 80°C , $\Delta T = 60^{\circ}\text{C}$, $g = 3.5 \text{ g/cm}^3$, and $C = 0.12 \text{ cal/g}^{\circ}\text{C}$, $d = 2.6 \times 10^{-4} \text{ cm}$ or if the ignition temperature is taken as 55°C ,

$$d = 4.4 \times 10^{-4} \text{ cm}$$

This value for the thickness of the hot layer is in agreement with the size of hot spot necessary for initiation by shock.

In view of the assumption made, however, this agreement should not be regarded as providing positive evidence for the thermal theory of initiation

Nitrogen iodide cannot be ignited under concentrated ammonia solutions even with a very strong flash. Under pure water local explosions

do occur, but the explosion is not propagated to the surrounding material. These observations may be explained in terms of the thermal theory. Water prevents the propagation of explosion simply by abstraction of heat. In the case of ammonia solutions, the inhibition is probably due both to cooling and to reaction with hydrogen iodide. The removal of hydrogen iodide prevents the secondary reactions with nitrogen iodide from taking place and so reduces the heat liberated during reaction"

Poole has ignited Nitrogen Iodide by a single α -particle from a radium source (Refs 5 & 14)

Bowden & Yoffe have suggested (Ref 12, pp 127-128 & Ref 14) that the abnormal sensitivity of NI_3 or $\text{NI}_3 \cdot \text{NH}_3$ is due to its being inherently unstable, and that the very slight external stimuli (slight touch, warm air, irradiation etc) primarily act to remove adsorbed NH_3 from the iodide surface.

Apparently this adsorbed NH_3 stabilizes the iodide and its removal causes the iodide to decompose spontaneously

Again we quote Bowden & Yoffe:

"Nitrogen iodide will explode when heated in air at 50°C . The equation representing the decomposition is (Ref 4)



Garner & Latchem (Ref 6) found that when nitrogen iodide ($\text{NI}_3 \cdot \text{NH}_3$) is dried over a layer of P_2O_5 at a pressure of 2×10^{-3} cm Hg, thermal decomposition could be studied at temperatures below 0°C . However, when the pressure fell below 2×10^{-3} cm Hg, explosion of the nitrogen iodide took place at temperatures as low as -11°C . At low pressures Meldrum (Refs 7 & 9) has shown that the equation representing the decomposition is different from that given above,

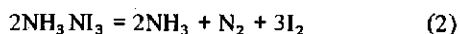

Ammonia and water vapor retard the decomposition of the nitrogen iodide, a pressure of 10^{-3} cm Hg of ammonia being sufficient to stop the reaction

The main effect of gas pressure is to slow down the rate of diffusion of ammonia away from the decomposing surface and so increase the stationary concentration of ammonia at this surface

The activation energy for Reaction (2) is 18-19 kcal/mole. It has been assumed that this is the energy required to remove ammonia from the surface of the solid $\text{NH}_3 \cdot \text{NI}_3$. After removal of the ammonia the NI_3 that is left is unstable and decomposes with the liberation of heat. The explosion then grows from this hot region; the reactions proposed being either

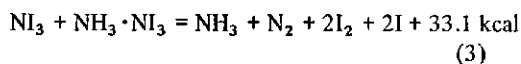

or

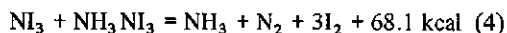

If iodine atoms are produced as in Equation (3) these could react further with ammonia to give ammonium iodide according to the equation (see Equation (1))

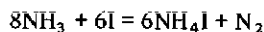

It is clear from the results described above that the presence of ammonia can under certain conditions prevent the explosion of nitrogen iodide when the decomposition is brought about by heat, light, shock, or ionizing radiation

The retarding action of ammonia has also been observed in the decomposition of a number of ammonium salts, eg ammonium perchlorate (NH_4ClO_4) and ammonium nitrate (NH_4NO_3) (Ref 10)"

Refs: 1) F.D. Chattaway, JCS **69**, 1572 (1896) 2) C. Hugot, CR **130**, 505 (1900) 3) F.D. Chattaway & K.J.P. Orton, AmChemJ **24**, 344 (1900) 4) J. Eggert, ZElektrochem **27**, 287 (1921) & CA **16**, 1013 (1922) 5) H.H. Poole, SciProcRoySoc (Dublin) **17**, 93 (1922) & CA **17**, 1583 (1923) 6) W.E. Garner & W.E. Latchem, TransFaradSoc **32**, 567 (1936) 7) F.R. Meldrum, Ibid, **34**, 947 (1938) 8) F.R. Meldrum, ProcRoySoc **A174**, 410 (1940) & CA **34**, 3568 (1940) 9) B. Meerkämper, ZElektrochem, **58**, 387 (1954) & CA **49**, 2194 (1956) 10) L.L. Bircumshaw & B.H. Newman, ProcRoySoc **A227**, 115 (1954) 11) J. Berchtold, ProcRoyPhotographic Soc of Great Britain (1953) p 250 (published 1955) 12) Bowden & Yoffe (1958) 13) J. Jander & E. Schmid, ZAnorguallgemChem **292**, 178 (1957) & CA **52**, 6037 (1958) 14) F.P. Bowden & A.D. Yoffe, Endeavour **21**, 125 (1962) & CA **58**, 1294 (1963) 15) Sax (1968) p 969-R

Iodides in Smoke Compositions. DeMent claims mixts of elements or cmpds consisting of or contg halogens, halide-forming elements or groups, an oxidant & a combustible material, such as iron, produce smokes of a large variety when ignited. More than 370 formulations are described. Suggested uses include military screening & signaling
 Ref: J. deMent, USP 2995526 (1961) & CA 55, 25100 (1961)

Iodine. Iodine added in quantities 1 to 5% to a liquid organic peroxide eliminates the danger of explosion and fires in its use, storage and shipment. Before use of the peroxide, the iodine is removed by an oxidizing agent or other suitable means
 Ref: H.C. Stevens, USP 2415971 (1947) & CA 41, 3114 (1947)

Iodine Azide. See under *Azides, Inorganic* in Vol 1, pp A542-543

Iodine Pentafluoride. The controlled reaction of IF_5 with dimethyl sulfoxide, Me_2SO , was found to be quite violent. Although small scale tests in the cold (0°) proceeded without incident, delayed violent explosions occurred upon scale-up or upon allowing the temp to rise to $10-15^\circ$
 Ref: E.M. Lawless, ChemEngNews 47 (13), 8 & 109 (1969) & CA 71, 40907 (1969)

Iodoazide. See under *Azides, Inorganic* in Vol 1, pp A542-543

Iodosoazidobenzene. See "Benzene and Derivatives" under *Azido Halogen Derivatives of Benzene* in Vol 2, p B44-R

Iodoxyazidobenzene. Ibid

Iodoazidoethane. $N_3CH_2CH_2I$; no explosive props mentioned in Beil 1, (33)

Iodoazoimide. $NI_3 \cdot 2NH_3$. See *Iodides* in this Vol. This name is used by Antelman (JChem-Educ 30, 134 (1953) & CA 47, 5741 (1953)) in describing some spectacular lecture demonstrations of incendiary & explosive reactions

IODOBENZENE AND DERIVATIVES

Iodobenzene or Phenyl Iodide. C_6H_5I ; mw 204.02; pale-yel liq, fr p -31.4° , d 1.832 at 20° , refractive index 1.621 at 20° . It is almost insol in water, but sol in alc, eth & chl. Iodobenzene is readily prepd by reaction of iodine with benzene in the presence of an oxidizing agent, or from benzenediazonium sulfate & potassium iodide

Refs: 1) Beil 5, 215, (118) [167] & [571] 2) Kirk & Othmer II (1966), 864

1-Azido-2-iodobenzene, $C_6H_4N_3I$; mw 245.03, N 17.15%; strong smelling oil, bp $90-91^\circ$ at 0.9 mm Hg, d 1.8893 at 25° , refractive index 1.6631 at 25° ; prepd by diazotizing aniline with NaN_3 . No expl props are reported. The 1-Azido-3-iodo- and 1-Azido-4-iodo-derivs are also known (Ref 2)

Refs: 1) Beil 5, (142) 2) Beil 5, 278 & (143)

Mononitroiodobenzene, $C_6H_4NO_2I$; mw 249.02, N 5.63%. The following isomers are known:

1-Nitro-2-iodobenzene, citron-yel ndls, mp 54° , bp $288-89^\circ$ (sublimes), d 1.9186 at 75° (Ref 1)

1-Nitro-3-iodobenzene, monoclinic crystals, mp $36-38^\circ$, bp 153° at 14 mm Hg, d 1.9131 at 75° (Ref 2)

1-Nitro-4-iodobenzene, dk-yel ndls (from alc), mp 172° , bp 287° at 726 mm Hg, explodes on heating in a tube at 605° (Ref 3)

Refs: 1) Beil 5, 252, (133), [190] & [621] 2) Beil 5, 253, (133), [191] & [622] 3) Beil 5, 253, (133), [191] & [623]

Dinitroiodobenzene, $(O_2N)_2C_6H_3I$; mw 294.03, N 9.53%. Six isomers are known:

1,2-Dinitro-3-iodobenzene, lt-yel ndls (from alc), mp 138° , distills without decomn (Ref 1)

1,2-Dinitro-4-iodobenzene, yel pltlts (from alc), mp 74.5° (Ref 2)

1,3-Dinitro-2-iodobenzene, orn-yel tablets (from alc), mp 113.7° (Ref 3)

1,3-Dinitro-4-iodobenzene, yel crystals (from alc or benzene), mp $88.5-90^\circ$ (Ref 4)

1,3-Dinitro-5-iodobenzene, golden-yel plates (from 60% alc), mp 99° (Ref 5)

1,4-Dinitro-2-iodobenzene, lt-yel prisms (from alc & eth) or almost colorless ndls (from alc), mp 117.4° (Ref 6)

Other props & methods of prepn are given in the Refs

Refs: Beil 5, 270 2) Beil 5, 270 & [202]
3) Beil 5, 270 & (139) 4) Beil 5, 270,
[202] & {641} 5) Beil 5, [202] 6) Beil
5, (139)

1,3,5-Trinitro-2-iodobenzene or Picryl Iodide, $(O_2N)_3C_6H_2I$; mw 339.02, N 12.39%; golden-yellow tetragonal ndls, mp 164-65°, d 2.285 at 22.5°; was first prepd from 2-chloro-1,3,5-trinitrobenzene & KI in the presence of alc.

Other props & methods of prepn are given in the Refs. No expl props are reported

Ref: Beil 5, 275, [207] & {647}

Iodochlorobenzene HCl salt or p-chloro

Phenyl iodide hydrochloride, $(ClC_6H_4I)HCl$,

yellow needles (from chl f); sol in chl f, glac HAc & benzene; sl sol in eth & petr eth; decomp slowly in stoppered dark vessel -

rapidly in sunlight. Decomp suddenly between 110° & 136°. Prepd by reacting phenyl iodide (in chl f) with chlorine $C_6H_5ICrO_4$ yel ppt which turns orange-red on drying explodes at 66-67° (no prep given)

Ref: Beil 5, 218

1-Iodo-2-Ethoxy-3 Butene, $CH_2ICOOC_2H_5CHCH_3$; mw 225.96. In the course of prepn by Petrov's method (Ref 1), the reaction can violently explode under certain undefined conditions. Ref 2 relates that several runs on a 0.16M scale were completed without incident. However, during a 1M run, the reaction exploded while ethanol was being distilled under sl vac at 35°. Controlled attempts to determine the cause were unsuccessful

Refs: 1) A.A. Petrov. ZhurObshchelKhim (JGenChem) 19, 1046-62 (1949) & CA 44, 1003 (1950) 2) J. Trent & P.G. Gassman, C&EN 44, No 43, 7 (1966)

IODOMETHANE AND DERIVATIVES

Iodomethane or Methyl iodide, CH_3I , mw 141.95; colorl liq, mp -66.1°, bp 42.5°, d 2.279; sol in alc or eth; sl sol in w. Prepd by reacting MeOH with NaI in the presence of sulfuric acid. Not explosive

Refs: 1) Beil 5, 69, (17), [35] & {93}.

2) CondChemDict (1971), p 576

Diodomethane or Methyleneiodide, CH_2I_2 , mw 267.87; colorl liq or leaflets at 0°, mp 5-6°, bp 180° (decomp), d 3.325; sol in alc or eth; sl sol in w. Prepd by reacting methylene chloride with NaI. Not explosive by itself but if mixed with K or K-Na alloys it explodes on shock
Refs: 1) Beil 1, 71, (18), [37] & [38]
2) CondChemDict (1971), p 573

Iodoform or Triiodomethane, CHI_3 ; mw 393.78; yellow leaflets, mp 115°, bp 260° (decomp), d 4.08; sol in w, alc, eth & chl f. Prepd by heating acetone (or methanol) with iodine in the presence of alkali. There is considerable confusion in the literature whether iodoform is an explosive. Beilstein (Ref 1), Sax (Ref 2), and CA 1947-1971 do not mention any explosive properties. Ref 3 states that iodoform decomps violently at 400°F. Friction makes a mixt of CHI_3+AgNO_3 decomp explosively (Ref 1)

Refs: 1) Beil 5, 73, (18), (19), [38], [102] & <97 > 2) Sax (1968), 840-R 3) CondChem-Dict (1971), 473-L

Iodonitromethane, CH_2INO_2 ; mw 186.9, N 7.50%; prepd by reacting methyl iodide in eth with $AgNO_2$ & a trace of iodine. Its Na salt, $NaCH(I)NO_2$, white powder, explodes on heating

Ref: Beil 1, 79 & {115}

Iododinitromethane, $CHI(NO_2)_2$, mw 231.9, N 12.1%. Its K-salt, prepd by slowly adding iodine to K-dinitromethane in aq KOH, orange-yellow platelets (from w); explodes violently at 154°. The Ag-salt, pale yellow leaflets, insol in w, explodes at 104-106°

Ref: Beil 1, 79 & [45]

Iodotrinitromethane or Iodopicrin, $CI(NO_2)_3$; mw 277.0, N 15.2%; no explosive props mentioned for it or its salts

Ref: Beil 1, 79 & [47]

2-Iodo-2-nitro-1,3-indandione,

$C_6H_4 \begin{matrix} CO \\ > \\ CO \end{matrix} CHI(NO_2)$; mw 317.05, N 4.42%,

OB -80.7%, mp 128°. Vanag & Lipman (Ref 2) warn that an explosion might take place when idonitroindandione is prepd by heating iodine with the silver salt of 2-nitro-1,3-indandione in a sealed tube at 130°. The silver salt of 2-nitro-1,3-indandione decomposes explosively at 239°

Refs: 1) Beil 7, 694, (375) & [632] (describes its parent compound 1,3-indandione 2) G.Ya.

Vanag & M.M. Lipman, Doklady Akad Nauk **68**, 693-6 (1949) & CA **44**, 1947 (1950)

Iodonitrophenols

The *2-Iodo-4,6-dinitrophenol*, $C_6H_3N_2O_5I$; mw 310.02, N 9.04%; mp 106-107° has been prepd (Ref 8). No explosive props are mentioned.

Other Iodo-dinitrophenol isomers are described in Beil; none is explosive:

4-Iodo-2,3-dinitrophenol (Ref 1)

5-Iodo-2,4-dinitrophenol (Ref 2)

6-Iodo-2,4-dinitrophenol (Ref 3)

4-Iodo-2,5-dinitrophenol (Ref 4)

3-Iodo-2,6-dinitrophenol (Ref 5)

The *3-Iodo-2,4,6-trinitrophenol* or *3-Iodopicric Acid*, $C_6H_2N_3O_7I$; mw 355.02, N 11.84%; is also known; mp 197°. It is prepd by nitrating iodophenol with mixed acid. No explosive props are mentioned for it or its salts (Refs 6 & 7)

Refs: 1) Beil **6**, 263 2) Beil **6**, [252]

3) Beil **6**, 263, (129) & [252] 4) Beil **6**,

263 & [252] 5) Beil **6**, 264 & [252]

6) Beil **6**, [283] 7) H.H. Hodgson & F.H.

Moore, JCS **1927**, 630 & CA **21**, 1974 (1927)

8) D.B. Murphy et al, JACS **75**, 4289 (1953) & CA **48**, 12075 (1954)

IODOSO COMPOUNDS

These are substances of the type $ArIO$. Apparently only aryl iodoso compds are known since no alkyl iodoso compds were found in the literature. Vibration spectra of several $ArIO$ compds are given in Ref 2. Individual explosive iodoso compds are described below. No other refs to explosive iodoso compds were found in CA 1947-1971

Iodosobenzene, C_6H_5IO ; mw 220.02; yel, amorphous pdr; sl sol in hot water & alc; almost insol in eth, acet, benzene, petr eth & chl. It explodes on heating to 210°, and explodes in the presence of concd nitric acid. Iodosobenzene was prepd by oxidation of iodobenzene with ozone

Refs: 1) Beil **5**, 217, (118), [166] & [575]

2) C. Furlani & G. Sartori, AnnChim (Rome) **47**, 124 (1957) & CA **51**, 8533 (1957)

Azidoiodosobenzene, $N_3C_6H_4IO$; mw 261.03, N 16.10%. Three isomers are known:

1-Azido-2-iodosobenzene, known in the form of its salts, some of which are very unstable (Ref 1)
1-Azido-3-iodosobenzene, yel amorphous mass, explodes at 125°. Its Formate explodes at 78° (Ref 2)

1-Azido-4-iodosobenzene, explodes on heating to 130° or in the presence of concd nitric or sulfuric acid. Its Chromate salt explodes by friction or by heating to 71°. Its Formate salt explodes at 85° (Ref 2)

Other props & methods of prepn are given in the Refs. It is claimed as a fusehead constituent by Ingram (Ref 3)

Refs: 1) Beil **5**, (142) 2) Beil **5**, (143)

3) L.K. Ingram, USP 2241406 (1941) & CA **35**, 5318 (1941)

Mononitroiodosobenzene, $O_2NC_6H_4IO$; mw 265.02, N 5.17%. Three isomers are known:

1-Nitro-2-iodosobenzene, orn colored prisms (from chl), mp - decomp at 100°. Its salts are unstable on heating (Ref 1)

1-Nitro-3-iodosobenzene, yel solid, mp, decomp on heating at low temp. Its Chromium salt, $O_2NC_6H_4ICrI_4$, orn pdr, explodes on heating to 95° (Ref 2)

1-Nitro-4-iodosobenzene, solid, mp - explodes at 82-83° (Ref 3). Its salts are unstable on heating

Other props & methods of prepn are given in the Refs

Refs: 1) Beil **5**, 252 2) Beil **5**, 253 & [622]

3) Beil **5**, 254, [191] & [624] 4) L.K. Ingram, USP 2241406 (1941) & CA **35**, 5318 (1941)

Dinitroiodosobenzene, $(O_2N)_2C_6H_3IO$, and *Trinitroiodosobenzene*, $(O_2N)_3C_6H_2IO$, derivatives not found in Beil

1-Iodoso-2-chlorobenzene, ClC_6H_4IO ; mw 254.5, white-yellow powder, v sl sol in eth, chl, benz or petr eth; somewhat sol in w. Explodes mildly at 83-85°. Prepd by passing chlorine into o-chloriodobenzene and then treating with dil NaOH. The *3-chloro isomer*, bright yellow needles, decomp at 100° & the *4-chloro isomer*, bright yellow amorphous mass, decomp at 116-117°
Ref: Beil **5**, 220 & 221

1-Iodoso-3-iodobenzene, $\text{IC}_6\text{H}_4\text{IO}$; mw 345.9, bright yellow amorphous powder; insol in usual org solvents; explodes mildly at 124° on rapid heating; on slow heating it melts (decomp) at 207° . Prepd by passing chlorine thru a chl soln of m-diiodobenzene
Ref: Beil 5, 225–226

1,3-Di-iodosobenzene, $\text{OIC}_6\text{H}_4\text{IO}$; mw 361.9, bright yellow amorphous powder, almost insol in all solvents; explodes around 108° . Prepd by passing chlorine thru a glac HAc soln of m-diiodobenzene
Ref: Beil 5, 226

m-Iodosotoluene, $\text{CH}_3\text{C}_6\text{H}_4\text{IO}$; mw 234.0, amorphous yellow powder, sol in cold glac HAc. Decomp at $180\text{--}85^\circ$; explodes at $206\text{--}07^\circ$. Prepd by passing chlorine thru a soln of m-iodosotoluene in chl. The ortho & para isomers decompose with gas evolution at $170\text{--}75^\circ$ & $175\text{--}78^\circ$, respectively, but no mention is made of their exploding
Ref: Beil 5, 310, 311 & 313

4-Iodoso-3-nitrotoluene, $\text{O}_2\text{NC}_6\text{H}_4(\text{CH}_3)\text{IO}$; mw 280.12, N 5.03%, red powder; explodes mildly at 129° . Prepd by passing chlorine thru a chl of 4-iodo-2-nitrotoluene and neutralizing with dil NaOH. The **Chromate salt**, $[\text{O}_2\text{NC}_6\text{H}_3(\text{CH}_3)\text{I}(\text{OH})_2]_2\text{CrO}_4$, red-orange crystals, explodes at 94° . The **Formic acid salt**, $\text{O}_2\text{NC}_6\text{H}_3(\text{CH}_3)\text{I}(\text{CH}_2\text{O})_2$, orange-colored powder, explodes mildly at 72° . The **Acetic acid salt**, $\text{O}_2\text{NC}_6\text{H}_3(\text{CH}_3)\text{I}(\text{C}_2\text{H}_3\text{O}_2)_2$, bright yellow needles, explodes at 200°
Ref: Beil 5, 337

2-Iodoso-4-nitrotoluene, O NC H (CH)IO , insol powder; explodes at $180\text{--}81$. Prepd as above from 2-iodo-4-nitrotoluene
Ref: Beil , 338

4-Iodoso-1-propylbenzene, $\text{CH}_3\text{CH}_2\text{CH}_2\text{C}_6\text{H}_4\text{IO}$; mw 262.0; decomp on storage; explodes at 105° . Prepd by passing chlorine thru a soln of 4-iodo-1-propylbenzene in chl & petr eth and then treating with a dil NaOH soln. Its **Perchlorate salt**, $\text{C}_9\text{H}_{11}\text{I}(\text{OH})\text{ClO}_4$ explodes at 73° and also explodes spontaneously on storage. The **Chromate**

salt also explodes spontaneously
Ref: Beil 5, 392

Iodotoluenes and Derivatives

Iodotoluene, $\text{CH}_3\text{C}_6\text{H}_4\text{I}$, is a stable non-explosive compd; so are its mononitro derivatives. Higher nitro derivs or azido derivs were not found in Beil
Ref: Beil 5, 310 & 337

IDOXY COMPOUNDS

As in the case of *iodoso* compds, the only *iodoxy* compds reported in the literature are ArIO_2 & *not* AlkIO_2 . Vibration spectra of several ArIO_2 compds are given in Ref 2. Individual explosive *iodoxy compds* are described below. No other refs to explosive *iodoxy compds* were found in CA 1947–1971

Iodoxybenzene, $\text{C}_6\text{H}_5\text{IO}_2$; mw 236.02; ndls (from benz), mp – explodes at $236\text{--}37^\circ$; almost insol in chl, acet & benz; v sl sol in petr eth; sl sol in hot water & glac acet acid. It can be prepd by oxidation of iodobenzene with various agents. Iodoxybenzene explodes in the presence of concd H_2SO_4 or phosphorus pentachloride. The **Perchlorate salt** is expl
Refs: 1) Beil 5, 218, (118), [167] & {576}
 2) R.L. Datta & J.K. Choudhury, JACS 38, 1079 (1916) & CA 10, 1749 (1916)

Azidoiodoxybenzene, $\text{N}_3\text{C}_6\text{H}_4\text{IO}_2$; mw 277.03, N 15.17%. Three isomers are known:

1-Azido-3-iodoxybenzene, brownish ndls (from glac acet acid), mp – explodes violently on heating to 157° or by friction (Ref 1)

1-Azido-3-iodoxybenzene, brownish ndls, mp – explodes on heating to $175\text{--}80^\circ$; sol in water & glac acetic acid (Ref 2)

1-Azido-4-iodoxybenzene, brn crysts, mp – explodes on heating to 170° , or in contact with concd H_2SO_4 (Ref 3). The **Chromate** of the 1,4 compd is a very dangerous, deep-red material that explodes at 71° or upon being rubbed lightly. Its **Formate** (in the form of plates) explodes at 85° . Its **Nitrate** melts at 102° with decomposition. The *iodoxyazidobenzenes* are claimed by Ingram (Ref 4) to be useful as fusehead ingredients

Other props & methods of prepn are given in the Refs

Refs: 1) Beil 5, (142) 2) Beil 5, (143)
3) M.O. Foster & J.H. Schaeppi, JCS 101, 1359
(1912) & CA 7, 330 (1913) 4) L.K. Ingram,
USP 2241406 (1941) & CA 35, 5318 (1941)

Mononitroiodoxybenzene, $O_2NC_6H_4IO_2$; mw
281.02, N 4.99%. Three isomers are known:

1-Nitro-2-iodoxybenzene, tablets (from glacial
acetic acid), mp – explodes violently at 210° ;
almost insol in eth, pet eth & benz; sl sol in glacial
acet ac, water & alc (Ref 1)

1-Nitro-3-iodoxybenzene, plates (from w), mp –
explodes on heating to $215-18^\circ$ (Ref 2)

1-Nitro-4-iodoxybenzene, wh plates, mp – explodes
at $212-13^\circ$; v sl sol in glacial acet ac (Ref 3)

Methods of prepn & other props are given in
the Refs

Refs: 1) Beil 5, 253 & {622} 2) Beil 5,
253 & {223} 3) Beil 5, 254, [191] & {624}

Dinitroiodoxybenzene, $(O_2N)_2C_6H_3IO_2$; mw
326.02, N 8.59%. Two isomers are found in
Beil

1,3-Dinitro-4-iodoxybenzene, plates or prisms
(from w) or prisms (from aq HNO_3), mp – ex-
plodes on heating to $140-60^\circ$. Can be prepd
by oxidation of 1,3-dinitro-4-iodobenzene (Ref 1)

1,4-Dinitro-2-iodoxybenzene, crystals, mp –
explodes on heating rapidly at 150° ; was prepd
by reaction of HOCl & 1,4-dinitro-2-iodobenzene
in glacial acet ac (Ref 2)

Refs: 1) Beil 5, [202] & {642} 2) Beil 5,
{642}

Trinitroiodoxybenzene, $(O_3N)_3C_6H_2IO_2$, not
found in Beil

1-Iodoxy-2-chlorobenzene, $C_6H_4(Cl)IO_2$;
mw 270.5; needles (from w), explodes at 203° ;
sol in w, alc & glacial HAc. Prepd by heating o-
chloroiodosobenzene in w or alc
Ref: Beil 5, 220

1-Iodoxy-3-chlorobenzene, $ClC_6H_4IO_2$; mw
270.47; colorl crystals, explodes at 233° ; sl sol
in w, alc or glacial HAc. Prepd by heating m-
chloroiodosobenzene in w
Ref: Beil 5, 220

1-Iodoxy-4-chlorobenzene, $ClC_6H_4IO_2$; mw
270.47; colorl crystals, explodes at 243° ; sl

sol in w, alc or glacial HAc. Prepd by heating
p-chloroiodosobenzene in w
Ref: Beil 5, 221

1-Iodoxy-2,5-dichlorobenzene, $Cl_2C_6H_3IO_2$;
mw 304.91, white needles (from hot w). Ex-
plodes mildly at 230° . Prepd by treating 2,5-
Dichloro-1-iodosobenzene with steam
Ref: Beil 5, 222

1-Iodoxy-4-bromobenzene, $BrC_6H_4IO_2$; mw
314.93; leaflets (from glacial HAc), explodes at
 240° ; sl sol in glacial HAc. Prepd by heating
p-bromoiodosobenzene in w
Ref: Beil 5, 224

1-Iodoxy-2,5-dibromobenzene, $Br_2C_6H_3IO_2$; mw
393.38; white amorphous powder, explodes at
 218° ; sl sol in hot w; sol in hot glacial HAc. Prepd
by treating 2,5-dibromo-1-iodosobenzene with steam
Ref: Beil 5, 224

1-Iodoxy-3-iodobenzene, $IC_6H_4IO_2$; mw 361.93;
colorless needles (from boiling w or glacial HAc),
explodes at $216-18^\circ$. Prepd by treating m-
iodoiodosobenzene with steam
Ref: Beil 5, 226

1-Iodoxy-4-iodobenzene, $IC_6H_4IO_2$; mw 361.93;
small needles (from glacial HAc), explodes around
 232° . Prepd by treating p-iodoiodosobenzene
with steam
Ref: Beil 5, 227

1,3-Di-iodoxybenzene, $IO_2C_6H_4IO_2$; mw 393.93;
white tablets, explodes very violently at 261° or
on impact; v sl sol in w or glacial HAc. Prepd by
heating m-diiodosobenzene with steam
Ref: Beil 5, 226

2-Iodoxytoluene, $CH_3C_6H_4IO_2$; mw 250.05;
white crystals, explodes at 210° . Prepd by
heating o-iodosotoluene in w. Its **Hydrofluoride**
salt, $C_7H_7IOF_2$, colorless leaflets, explodes
mildly at 180°

4-iodoxytoluene, $\text{CH}_3\text{C}_6\text{H}_4\text{IO}_2$; mw 250.05; prepd as above from p-iodosotoluene. It melts with decomp at 229°

Ref: R.L. Datta & J.K. Choudhury, *JACS* **38**, 1079 (1916) & *CA* **10**, 1749 (1916)

4-Iodoxy-1,3-dimethylbenzene, also called asym Iodoxy-m-xylene, $(\text{CH}_3)_2\text{C}_6\text{H}_3\text{IO}_2$; mw 264.07; small crystals (from glac HAC) or amorphous powder (from w), explodes at 195° ; sol in hot w or HAC. Prepd by passing chlorine thru a soln of asym iodo-m-xylene in pyridine

Ref: Beil **5**, 376

5-Iodoxy-1,3-dimethylbenzene, also called asym Iodoxy-m-xylene, $(\text{CH}_3)_2\text{C}_6\text{H}_3\text{IO}_2$; mw 264.07; leaflets (from w), explodes at 216° . Prepd by steam distilling asym iodo-m-xylene. Datta & Choudhury claim that both the 4 & 5-Iodoxy-isomers explode at 193° (Ref 2)

Refs: 1) Beil **5**, 377 2) R.L. Datta & J.K. Choudhury, *JACS* **38**, 1079 (1916) & *CA* **10**, 1749 (1916)

4-Iodoxy-1-methyl-2-ethylbenzene, $\text{CH}_3\text{C}_6\text{H}_3(\text{C}_2\text{H}_5)\text{IO}_2$; mw 278.10; white leaflets, explodes at 229° . Prepd by heating 4-Iodoso-1-methyl-2-ethylbenzene in w

Ref: Beil **5**, 396

4-Iodoxy-1-methyl-3-ethylbenzene, $\text{CH}_3\text{C}_6\text{H}_3(\text{C}_2\text{H}_5)\text{IO}_2$; mw 278.10; white leaflets, explodes at 229° . Prepd by treating corresponding methyl-ethyl-iodobenzene with Na hypochlorite soln

Ref: Beil **5**, 396

4-Iodoxy-1-propylbenzene, $\text{CH}_3\text{CH}_2\text{CH}_2\text{C}_6\text{H}_4\text{IO}_2$; mw 278.10; leaflets (from w), explodes at $185-200^\circ$. Prepd by storing corresponding iodoso compd in w

Ref: Beil **5**, 393

5-Iodoxy-1,2,4-trimethylbenzene, $(\text{CH}_3)_3\text{C}_6\text{H}_2\text{IO}_2$; mw 278.10; small needles (from glac HAC), explodes mildly at 212° ; sl sol in chl_f; insol in eth or benz. Prepd by heating the corresponding iodoso compd in w

Ref: Beil **5**, 404

2-Iodoxy-1,3,5-trimethylbenzene, $(\text{CH}_3)_3\text{C}_6\text{H}_2\text{IO}_2$; mw 278.10; needles (from glac HAC), explodes at 195° ; sl sol in glac HAC or alc. Prepd by heating Iodomesitylene and treating it with steam

Ref: Beil **5**, 409

4-Iodoxy-1-tert-butylbenzene, $(\text{CH}_3)_3\text{CC}_6\text{H}_4\text{IO}_2$; mw 292.12; crystalline, explodes at 201° ; sol in glac HAC; insol in w. Prepd by reacting p-tert-butyl-iodo-chlorobenzene with Na hypochlorite soln

Ref: Beil **5**, 417

4-Iodoxy-1-isoamylbenzene, $(\text{CH}_3)_2\text{CHCH}_2\text{CH}_2\text{C}_6\text{H}_4\text{IO}_2$; mw 306.15; tablets (from w or glac HAC), explodes at $200-03^\circ$.

Prepd by oxidation of p-iodoso-isoamylbenzene with a Na hypochlorite soln

Ref: Beil **5**, 435

Ion Exchange is defined in the Condensed Chemical Dictionary (Ref 31) as:

"A reversible chemical reaction between a solid (ion exchanger) and a fluid (usually a water solution) by means of which ions may be interchanged from one substance to another. The superficial physical structure of the solid is not affected. The customary procedure is to pass the fluid through a bed of the solid, which is granular and porous, and has only a limited capacity for exchange. The process is essentially a batch type in which the ion exchanger, upon nearing depletion, is regenerated by inexpensive brines, carbonate solutions, etc. Ion exchange occurs extensively in soils

Ion exchange resins are synthetic resins containing active groups (usually sulfonic, carboxylic, phenol, or substituted amino groups) that give the resin the property of combining with or exchanging ions between the resin and a solution. Thus a resin with active sulfonic groups can be converted to the sodium form and will then exchange its sodium ions with the calcium ions present in hard water. "Amberlite" resins are of this type

Some specific applications of ion exchange: water softening; milk softening (substitution

of sodium ions for calcium ions in milk); removal of iron from wine (substitution of hydrogen ions); recovery of chromate from plating solutions; uranium from acid solutions; streptomycin from broths; removal of formic acid from formaldehyde solutions; demineralization of sugar solutions; recovery of valuable metals from wastes; recovery of nicotine from tobacco-dryer gases; catalysis of reaction between butyl alcohol and fatty acids; recovery and separation of radioactive isotopes from atomic fission; chromatography; establishment of mass micro standards; in cigarette filters to remove polonium from smoke"

The discovery of the phenomenon of ion exchange is attributed to H.M. Thompson & J.T. Way, British agricultural chemists. They reported in 1848 the exchange of Ca and NH_4 ions in soils. No practical application of this discovery was made, however, until the German chemist R. Gans proposed (in about 1910) to apply the ion exchange principle to water softening. The first successful organic ion exchange materials appeared on the market about 1935, and about the same time I.G. Farben-industrie started a systematic research program

Since that time, the ion exchange industry, using various resins, has expanded enormously. Among the scientists who have contributed to the ion exchange industry, the following may be mentioned; O. Liebknecht & R. Griessbach of Germany, P. Smit of Holland, B.A. Adams & E.H. Holmes of Great Britain, H.L. Tiger, S. Sussman & A. Mindler of the United States and L. Wiklander of Sweden

The ion exchange substances used commercially at present (in particular, ion exchange resins) are ionic solids in which one of the ionic species (either an anion or cation) is a highly cross-linked, polymeric, high molecular weight, non-diffusible ion, whose multivalent charge is balanced by relatively small diffusible ions of the opposite charge. These exchangers constitute a class of electrolytes having properties that are in many respects similar to true solutions of electrolytes

The chief advantage of an ion exchange technique lies in simplicity and rapidity with which various separations or concentrations may be achieved. The application of ion exchange technique in analytical chemistry

includes: concentration of dilute solutions, fractionation of ions having similar analytical properties, removal of interfering ions etc. Chromatographic technique is one of the branches of ion exchange technique. The ion exchange technique has found extensive application in the purification of water for laboratory uses, to replace the more expensive distilled water

Refs: 1) B.A. Adams & E.L. Holmes, *JSCI* **54**, 1-6T (1935) 2) R. Griessbach, *AngewChem* **52**, 215 (1939) 3) H.L. Tiger & S. Sussman, *IEC* **35**, 186 (1943) 4) O. Samuelson, *Studies on Cation Exchange Resins*, Thesis, Hørsal, Sweden (1944) 5) S. Sussman & A.B. Mindler, *ChemInds* **56**, 789 (1945) 6) I.M. Kolthoff & E.B. Sandell, "Textbook of Quantitative Inorganic Analysis," Macmillan, NY (1945), p 116 7) L. Winklander, *Kgl Lantbruks-Högskol*, *Ann* **14**, 1 (1946) (Sweden) 8) Anon, *Resinous Reporter* **9**, No 4, p 1 (July 1948) 9) R. Kumin, *IEC* **40**, 41-45 (1948) (Ion exchange with 123 references) (and in January numbers of succeeding years, under Unit Operations) 10) F.C. Nachod, Ed, *Ion Exchange; Theory and Application*, Academic Press, NY (1949) 11) R. Kunin, *AnalChem* **21**, 87-96 (1949) (Ion exchange in analytical chemistry; 54 references are included) 12) R. Kunin & R.J. Myers, *Ion Exchange Resins*, J Wiley, NY (1950) 13) R. Oda & H. Shimzu, *Ion Exchange Resins*, Gakujutsu Pull Co, Japan (1950) 14) R.E. Kirk & D.F. Othmer, *Encyclopedia of Chemical Technology*, Interscience, NY, v 8 (1952), pp 1-17; R. Kunin, *Ion Exchange*, with 39 references 15) R. Kunin, *IndEngChem* **58** (11), 104 (1966) & *CA* **66**, 12376 (Review of ion exchange technology & theory) 16) P. Miro Plans, *IngQuim (Mex)* **11** (119), 44 (1966) & *CA* **66**, 59134 (1967) (Review in Spanish) 17) R. Kunin, *EncyclIndChemAnal* **2**, 346 (1966) & *CA* **66**, 72047 (1967) (Review with 31 refs) 18) R.M. Wheaton & A.H. Seamster, *Kirk-Othmer EncyclChemTechnol*, 2nd ed, **11**, 871 (1966) & *CA* **67**, 25983 (1967) (60 refs) 19) R. Kunin & R.L. Gustafson, *IndEngChem* **59** (11), 95 (1967) & *CA* **67**, 118546 (1967) (146 refs) 20) S.B. Applebaum, "Demineralization by Ion Exchange: Water Treatment & Chemical Processing of Other Liquids," Academic, NY (1968) & *CA* **69**, 108144 (1968) 21) R.

Kunin & R.L. Gustafson, *IndEngChem* **60** (11) 57 (1968) & *CA* **70**, 5452 (1969) (285 refs)
 22) K. Chandrasekharan, *ChemAgeIndia*, **19** (8), 666 (1968) & *CA* **70**, 39192 (1969) (42 refs)
 23) J.A. Marinsky, Ed, "Ion Exchange," vol 2, Dekker, NY (1969) & *CA* **70**, 91128 (1969)
 24) R. Kunin & R.L. Gustafson, *IndEngChona* **61**, (12), 38 (1969) & *CA* **72**, 68578 (1970) (370 refs)
 25) G.V. Samsonov et al, "Ion Exchange: Sorption of Organic Substances," Leningrad, Nauka (1969) & *CA* **73**, 29355 (1970) (in Russian)
 26) G. Kuehne, *Fortschr Verfahrenstech* 1966-1967, **8**, 545 (1969) (Ger) & *CA* **73**, 38854 (1970) (323 refs)
 27) R. Patterson, "An Introduction to Ion Exchange," London, Hayden (1970) & *CA* **73**, 91824 (1970)
 28) K. Stambert, "Construction-Technological Problems of Ion Exchange Applications," Berlin, Akad-Verlag (1970) & *CA* **74**, 32962 (1971) (in Ger)
 29) K.M. Saldadze, *Plast Massy* **1970**, 282 (Russ) & *CA* **74**, 76873 (1971) (71 refs)
 30) G.V. Samsonov & N.I. Nikitin, Eds, "Ion Exchange & Ion Exchangers," Leningrad, Nauka (1970) (Russ) & *CA* **74**, 103454 (1971)
 31) *CondChemDict*, 8th Edit, (1971), p 474

Ionic Energy in Propulsion. See *Propulsion, Ionic* in future Vol

IONIZATION IN DETONATION AND SHOCK WAVES. See *Detonation (and Explosion); Electrical, Electromagnetic Effects Accompanying It* in Vol 4, pp D258-264; *Detonation, Flash-Across, Heat Pulse and Hyper-Velocity Phenomena* in Vol 4, pp D348-349; *Detonation (and Explosion); Phenomena Accompanying It* in Vol 4, p D471; *Detonation, Plasma In* in Vol 4, pp D471-474; *Detonation Velocity, Influence of Magnetic, Electro Magnetic and Electrical Fields as well as of Electrons on* in Vol 4, pp D668-671; and *Heat Pulse* in this Vol

Since the appearance of Vol 4, relatively little has been published on ionization in detonation waves, or ionization in shocked condensed media. However, there is considerable new information on shock ionization of gases. We discuss these phenomena below

Ionization in a Detonation Wave. Hay et al (Ref 9) obtained high-speed framing camera pictures and time-resolved spectrograms of the

detonation of solid explosives in a high vacuum. The salient feature of these observations is the very high velocity, 20 km/sec, of the leading products emitted from the ends of charges of explosives which contain hydrogen. These authors propose two mechanisms which might account for these high-speed emissions. They obviously favor mechanism 1). We quote:

"1. The mechanism of ambipolar diffusion can be invoked to double the speed of the ionized portion of the cloud. In ambipolar diffusion, a pressure gradient in the plasma at the surface of the explosive will tend to accelerate the electron gas at several thousand times the rate for ions. Any tendency for the electrons to move ahead of the ions, however, is quickly balanced by an electric field caused by the separation of charges. The electrons, being highly mobile in comparison to the ions, will quickly achieve a near equilibrium between the influences of the pressure gradient and electric field. However, the same electric field acts on the ions but in the same direction as the pressure gradient. This subjects the ions to a total force away from the surface double that on a neutral species. An order of magnitude calculation shows that a charge separation of even a tenth of a percent creates an electric field which would produce forces on the charged particles many orders of magnitude greater than the pressure gradient. The difference in arrival times of various species (hydrogen, lithium, sodium) in the pink glow is presumably due to the fact that the same pressure and electric field act on both light and heavy species in the detonation "plasma," accelerating the lightest species the most

2. The mechanism proposed by Johansson and Selbert (Ref 3) which invokes elastic collision between heavy molecules in the detonation products and lighter molecules in the ambient gas. Although this is an attractive hypothesis, it appears doubtful that the lighter molecules actually come from the ambient gas for two reasons: (a) the intensity of the light emitted when these molecules impinge on a surface ought to increase as the number of available molecules increases; however, over a million-fold increase in ambient pressure (10^{-7} to 10^{-1} torr) no obvious increase in luminosity was observed;

(b) velocities of the sodium atoms or ions, which certainly do not originate in the ambient gas, are very nearly as high as those of the hydrogen atoms, molecules or ions"

The use of *ionization pins* or *pin switches* in the measurement of detonation velocity was described in Vol 4, pp D632-638. Their principle of operation is the closure of an electric circuit by the ionization associated with a detonation wave. The latest *pin switch* techniques are described in Ref 11

Shock Ionization in Condensed Media. Dremin et al have studied shock polarization of both polar & nonpolar liquids. They conclude that these polarizations are ionic in nature. We quote from a recent article by Dremin & Yakushev:

"It has been found in studying polarization of liquid dielectrics in shock waves, that liquids involving polar molecules, such as water, acetone, chlorobenzene, bromobenzene, iodobenzene, nitrobenzene, and others (Ref 5) give polarization signals. When shock waves are propagated over nonpolar liquids such as benzene, carbon tetrachloride, etc, no polarization signals appear (Ref 8). In this connection, an assumption arose that with decomposition of nonpolar molecules of a liquid behind the front of a shock wave into polar fragments, a polarization signal may be obtained from propagation of a second reflected shock wave over a shock-compressed substance (Ref 8). Carbon tetrachloride was the liquid used"

On the basis of their results as well as the results of others, Dremin & Yakushev conclude:

"The electrochemical nature of signals observed for all liquids studied is evidence that the electric conductivity arising on shock compression is of an ionic nature. Hamann and coworkers (Refs 1, 2, 6 & 7) came to the same conclusion when studying the conductivity of water, methanol and acetone in shock waves

The persistence of transparency on shock compression of water, methanol and dichlorethane within the range of pressures corresponding to good conductivity (Ref 4) is another evidence in favor of the ionic nature of these liquids under the given conditions"

Refs: 1) H.G. David & S.D. Hamann, *TransFaradSoc*, **55**, 72 (1959) 2) H.G. David, S.D. Hamann, *TransFaradSoc*, **56**, 1043 (1960) 3) C.H. Johans-

son & H.L. Selberg, "Transient High Temperature Gas Layers in Detonation," *Proc 4th IntlConf Ionization Phenomena in Gases*, Uppsala, Aug 17-21, 1959, IVD 1114 (1960 4) Ya. B. Zel'dovich et al, *DoklAkadNauk SSSR*, **138**, 1333 (1961) 5) R.J. Eichelberger & G.E. Hauver, *Les Ondes de Detonation*, Paris, (1962) p 363 6) S.D. Hamann & M. Linton, *TransFaradSoc* **62**, 1, (1966) 7) S.D. Hamann, *Effects of Intense Shock Waves in Advances in High Pressure Research 1*, ed by R.S. Bradley, Academic Press, London & NY (1966) 8) V.V. Yakushev et al, *JETP, Letters*, **7**, 165 (1968) 9) J.E. Hay et al, *5th ONRSympDet* (1970) p 559 10) A.N. Dremin & V.V. Yakushev, *Ibid*, p 399 11) J.P. Sumner, *Proc Symp on Behavior & Utilization of Explosives in Engineering Design*, Albuquerque, NM (1972) p 230

Shock Ionization of Gases. If temperatures behind a shock front are in the range of 15000-20000°K the gas through which the shock is moving will be appreciably ionized. The establishment of ionization equilibrium is the rate-determining step in this process and consequently controls the thickness of the wave front (Ref 6)

The ionization process is quite complex, and to avoid even further complications, the following discussion will be limited entirely to the shock-ionization of monatomic gases. One compelling reason for doing this is that complications due to dissociation (eg of N₂ or more complex polyatomic molecules) are thus avoided. Furthermore for a given driver shock, the highest temperatures, and consequently the greatest likelihood of ionization, occur in monoatomic gases since such gases cannot "soak-up" energy in internal modes, ie, in rotation or vibration. In what follows A represents an atom of gas (Argon by preference since much of what follows is derived from studies of shocked Argon). The main steps in the process are represented by the following *equilibria*:

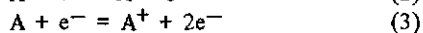
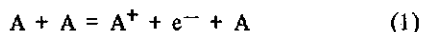

Electron avalanching via (3) is the main process for producing A⁺ ions. However this requires the presence of "priming" electrons which can be

produced by A + A collisions in the shock (step (1)) or photoelectrically by the absorption of sufficiently energetic radiation to photoionize A (step (2)). However, under shock conditions where ionization is observed, the best evidence suggests that steps (1) & (2) cannot provide a sufficient number of "priming" electrons for step (3). This discrepancy is still unresolved (Ref 6). Biberman & Yakubov (Ref 4) have suggested that absorption of resonant radiation from the equilibrium region produces many A atoms that are electronically excited; such atoms are then readily ionized by electron impact and thus lead to electron avalanching.

Equilibrium calculations based on combining the *Saha* equation (in terms of the internal partition functions of A, A⁺ & e⁻) with the conservation conditions for the shock are fairly involved (Ref 1). We chose instead to derive the following set of equations for an idealized case, which, though they overestimate the degree of ionization and underestimate the temperature, point out the shock and gas parameters that control the ionization of monoatomic gases.

Consider a perfect gas of molecular weight M which has been shocked and has attained ionization equilibrium with the fraction of atoms ionized designated by α . For a shock pressure P, much greater than ambient pressure, gas density ρ in the shock and ρ_0 ahead of the shock and a shock velocity U, the conservation conditions lead to:

$$P = \rho_0 U^2 (1 - \rho_0/\rho) = \rho_0 \mu U^2 \quad (1)$$

where $\mu \equiv 1 - \rho_0/\rho$, and

$$\Delta E = \frac{1}{2} P (1/\rho_0 - 1/\rho) = \frac{1}{2} \mu^2 U^2 \quad (2)$$

combining Eq (1) with the perfect gas law gives

$$P = \rho_0 \mu U^2 = \rho (1 + \alpha) RT/M \quad (3)$$

or

$$T = \rho_0 \mu U^2 M / \rho (1 + \alpha) R = \mu (1 - \mu) U^2 M / (1 + \alpha) R \quad (4)$$

If we assume that a negligible amount of energy is used in electronic excitation of the A atoms, then the incident shock energy ΔE is used to ionize some of the A atoms and to heat the mixture of ionized and neutral atoms. This energy balance is expressed by:

$$\Delta E - \Delta I \approx c_v \Delta T \quad (5)$$

where ΔI is the total ionization energy of the

gas and c_v is the const vol heat capacity of the equilibrium gas. From kinetic theory $c_v = 3/2 R/M$, which, combined with Eq (2), leads to:

$$\frac{1}{2} \mu^2 U^2 - \alpha I_1 / M \approx 3/2 (1 + \alpha) R \Delta T / M \quad (6)$$

because at equilibrium there are $(1 - \alpha)$ moles A, α moles A⁺ & α moles e⁻ or a total of $(1 + \alpha)$ moles of "monoatomic" gas. Here I_1 is the first ionization potential of A, ie we are neglecting all but singly ionized species. Since $\Delta T = T - T_0$ and if $T \gg T_0$ ($T \sim 10000$ to $50000^\circ K$ which is much greater than $T_0 = 300^\circ K$), Eq (6) gives,

$$T \approx \mu^2 U^2 M / 3(1 + \alpha) R - 2/3 \alpha I_1 / (1 + \alpha) R \quad (7)$$

and after rearranging, combining terms, & eliminating T via Eq (4):

$$\alpha = \frac{U^2 M}{2 I_1} [\mu^2 - 3(1 - \mu)\mu] = \frac{U^2 M \mu}{2 I_1} [4\mu - 3] \quad (8)$$

and

$$T = \mu (1 - \mu) U^2 M / [1 + U^2 M \mu (4\mu - 3) / 2 I_1] R \quad (9)$$

Eq 8 immediately tells us that the degree of ionization depends strongly on the shock velocity U. For strong shocks $\mu \approx$ constant ≈ 0.9 (see Fig 6 of Ref 2) for all monoatomic or even polyatomic gases. Thus the only important shock parameter is U. Similarly the only important gas parameters are the molecular weight M and the first Ionization potential I_1 .

It is instructive to examine the noble gases in terms of Eqs 8 & 9. In the series He to Xe, M increases and I_1 decreases, thus at a given U and a nearly constant μ , the degree of ionization α is much greater for Xe than for He..

In fact α increases regularly in the series He < Ne < Ar < Kr < Xe. Temperature of the shocked gases also increases in the same manner but not as greatly as α because the additive term in the denominator of Eq 9 increases progressively from He to Xe and tends to counteract the increase in M in this progression.

For strongly shocked Argon (see Table 1), calculations based on Eq 8 give α 's that are 30 to 40% higher than the more accurate (partition function) calculations of Reynolds

Table 1.
Comparison of Approximate and Exact Calculations (Ref 2) for Shocked Argon

U mm/ μ sec	ρ/ρ_0	ρ/ρ_0 (Ref 2)	μ	μ (Ref 2)	α Eq 8	α (Ref 2)	T Eq 9	T (Ref 2)
8	10	9.00	0.900	0.889	0.454	0.322	19000	23100
	9.5		0.895		0.436		20200	
	9.0		0.889		0.410		21500	
	8.5		0.882		0.393		22800	
9	10	9.63	0.900	0.896	0.574	0.417	22200	25500
	9.5		0.895		0.552		23600	
	9.0		0.889		0.518		25200	
10	10.5	10.1	0.905	0.901	0.736	0.523	23800	28350
	10.0		0.900		0.709		25300	
	9.5		0.895		0.681		26900	

& Seely (Ref 2). This is to be expected since we neglected the energy used in electronic excitation of Ar atoms and this neglect shows up as increased ionization. Our calculated temperatures (see Table 1) are about 10% lower than Seely's (Ref 2) if ρ/ρ_0 is the same in both calculations. Presumably this better agreement between temperature and α 's is due to the following compensating effect. Inclusion of electronic excitation would make it appear as an additional negative term in Eq (7) and would tend to reduce T. However, inclusion of electronic excitation makes α smaller. Thus the first right-hand term of Eq (7) becomes larger and the second (negative) term becomes smaller, both of which tend to increase T and counteract the direct effect of including a negative term for electronic excitation

There are no direct measurements of the degree of ionization of strongly shocked noble gases. Thus the validity of the above discussion can only be tested indirectly by comparing computed shock temperatures (which contain

terms in α) with measured shock temperatures

Shock temps and shock velocities in Ar were measured by the writer (Ref 3) & Zatsepin et al (Ref 7). Velocities and temps of shocks in Kr & Xe were also measured by the writer (Ref 5) and shock temps in Xe by Zatsepin et al (Ref 7). The shock velocity of 8.3 mm/ μ sec reported for Ar in contact with Comp B (Ref 3) is incorrect. This is an average velocity of the propagation of intense luminosity and/or ionization which changes very little over at least 10cm travel from the Comp B face except in the region very close to the Comp B. Unfortunately it is the shock velocity in this close-in region that we need since peak temp is achieved within 1 μ sec of the shock entry into the Ar. Our best estimate of U for Ar in the close-in region is ~ 10 mm/ μ sec. The values of U for Comp B driven Kr & Xe, to be used in Table 2, are also estimates for the close-in region. They are quite tentative since they are based on few data

Table 2.
Shock Temperatures of Noble Gases

Gas	U _{obs} (mm/ μ sec)	T _{obs} ($^{\circ}$ K)	(ρ/ρ_0) calc	Uncorrected	Corrected
				T _{calc} ($^{\circ}$ K)	T _{calc} ($^{\circ}$ K)
Ar	~ 10	28500	10.1 (a)	25300 (c)	28700 (d)
Kr	~ 7.6	~ 37500	8.6 (b)	32600 (c)	37600 (d)
Xe	~ 6.8	~ 47500	7.8 (b)	40200	47000 (d)

(a) Ref 2

(b) Assumed to be the same as for Ar (Ref 2) at the corresponding U

(c) According to Eq 9 with α obtained via Eq 8

(d) All α 's arbitrarily reduced by a factor of 1.4

Agreement between experiment and computation is good if one assumes that, as appears to be the case for Ar, all "accurate" α 's are 40% smaller than the corresponding α 's computed via Eq 8. A presumably exact calculation (no details given) by Zatsepin et al (Ref 7) gives a shock temp of $\sim 37000^\circ\text{K}$ (?) for a shock in Xe moving at $U = 6.8 \text{ mm}/\mu\text{sec}$ and $\sim 29000^\circ\text{K}$ for shock in Ar moving at $10 \text{ mm}/\mu\text{sec}$

Written by J.. ROTH

Refs: 1) J.W. Bond, Jr, "The Structure of a Shock Front in Argon," LA-1693, LASL (1954) 2) C.E. Reynolds & L.B. Seely, *Nature* **199** (4891) 341 (1963) & *CA* **59**, 7009 (1963) 3) J. Roth, *JApplPhys* **35** (5), 1429 (1964) 4) L.M. Biberman & I.T. Yakubov, *Soviet Phys-TechPhys (English Transl)* **8**, 1001 (1964) 5) J. Roth, unpublished result (1965) 6) Ya. B. Zel'dovich & Yu. P. Raizer, *Physics of Shock Waves and High Temperature Hydrodynamic Phenomena*, Vol 2, Acad Press (1967) Chapt VII Sect 10-12 7) Yu. A. Zatsepin et al, *ZhEksp-TeorFiz* **54**, 112 (1968) & *Soviet Phys JETP* **27** (1) 63 (1968)

Ions; Action on Explosives. Källmann & Schränkler (Ref 2) claim that Mercuric Fulminate, Azides & even TNT were initiated by the action of H, Ar & Hg ions. This was not substantiated (Ref 3). Nitrogen Iodide is definitely initiated by α -particles (Refs 1 & 4) but it is atypical, see *Iodides* and *Initiation* in this Vol

Refs: 1) H.H. Poole, *SciProcRoySoc (Dublin)* **17**, 93 (1922) 2) H. Källmann & W. Schränkler, *Naturenwissenschaften*, **21**, 379 (1933) & *CA* **27**, 5979 (1933) 3) Bowden & Yoffe (1958) p 113 4) F.P. Bowden & A.D. Yoffe, *Endeavour* **21**, 125 (1962) & *CA* **58**, 1294 (1963)

IPA Composition. Recognizing that the hygroscopicity of Black Powder is due largely to the charcoal, a non-hygroscopic ignitor-type pdr was developed. It was found that substituting Tetranitrocarbazole (See Vol 2, pC48-L) for charcoal results in a compn, designated IPA Composition, which

is only half as hygroscopic as Blk Pdr and can be made only one-fifth as hygroscopic by the use of chemically pure instead of spec grad K nitrate

Ref: S. Livingston, *PATR* **647** (March 1947)

Ipatieff, V.N. (1867-1952). Vladimir Nikolaevich Ipatieff, of Universal Oil Products Co and Northwestern University, was born in Moscow and attended military schools under the czarist regime. His work carried him to a high position in the Russian army and to recognition as one of the outstanding scientists of Russia

Although he had been interested in chemistry since boyhood, his studies in organic chemistry began at 27 when he presented a thesis dealing with the addition of hydrogen bromide to unsaturated hydrocarbons, a reaction which soon led to the proof of structure of isoprene. He studied in both Germany and France and on returning to Russia he presented a thesis on the synthesis of isoprene. His work on decomposition of organic compounds at high temperatures with special catalysts, he began about 1900. His work on the dehydration and dehydrogenation of alcohols and their combination in the preparation of butadiene from alcohol has formed the base for much of the synthetic rubber development in the US. He later developed the first high pressure bomb for catalytic reactions, then found promoters which aided the catalysts in their activity. From these discoveries branched his work in hydrogenation (both organic and inorganic), isomerization, polymerization, condensation, cyclization, alkylation, and related reactions

It was at his brother's home that the Czar had taken refuge and was assassinated at the time of the revolution in Russia. Dr. Ipatieff managed to continue his research under the new regime but this became increasingly difficult and he finally left Russia permanently, abandoning all his financial assets. Through the efforts of Gustav Egloff of Universal Oil Products and Ward Evans of Northwestern University, who arranged for him to carry on work here, he came to the United States in 1931. He was denounced

by the Soviet government for his refusal to return to that country and the honors which had been conferred upon him were withdrawn.

Among his many honors were election to both the American and Russian Academies of Sciences, the Willard Gibbs Medal of the Chicago Section of the ACS, the Berthelot Medal, the Lenin Prize, and honorary doctor's degrees. Out of the income from a trust fund set up by Dr and Mrs Ipatieff the Ipatieff Prize was established several years ago which would encourage work in the field of catalysis and high pressure.

At both the Universal Oil research laboratory and the Ipatieff Catalytic Laboratory at Northwestern (an extension of the original laboratory set up by Ipatieff) Dr Ipatieff was active almost to the time of his death.

Ref: Anon, Chem & Engr News 30, 5300 (1952)

IRECO Chemicals. IRECO Chemicals was organized in Salt Lake City, Utah, in 1962 from a merger of Intermountain Research and Engineering Company and Mesabi Blasting Agents, Inc, for the purpose of commercializing slurry explosives. Slurry explosives were invented by Dr. Melvin A. Cook and H. Earl Farnam, Jr, in 1956 and represent a major breakthrough in explosives technology, the magnitude of which can be compared with dynamite's victory over Black Powder in the 1860's.

Slurry explosives are based upon a system consisting of oxidizing agents and nonexplosive fuel materials. The explosive energy derived from these unique explosives is the result of extremely rapid reduction-oxidation reactions between the fuels and oxidizers upon initiation by a high explosive booster. A slurry explosive can be visualized as a colloidal system which comprises basically two phases, a dispersion phase and a dispersed phase. The fundamental concept which led to the discovery of slurry explosives was that an aqueous oxidizer solution (eg ammonium nitrate) could be used as the dispersion medium of a colloidal system to disperse the required fuel (aluminum) and thereby achieve a multiplicity of beneficial results.

A particularly significant feature of the slurry explosives is that they are easily made water resistant by means of a suitable hydrophilic

colloid which binds the solid particles of the system together and prevents diffusion of water into or out of the products. Other principal advantages of slurry explosives are substantially increased safety, greater overall economy, more favorable fume characteristics, and ease of varying the energy and density to enable custom designing of the explosive for each specific application to ensure optimum energy/cost ratios. These and many other favorable characteristics have enabled slurry explosives to replace conventional explosives in mining, quarrying, and construction operations around the world.

Prior to its merger into IRECO Chemicals, Intermountain Research and Engineering Company (IRECO—founded in 1958) pioneered the early development of slurry explosives under a contract from the Iron Ore Company of Canada (IOCC) who owned the original Cook and Farnam invention.

Although the original slurries had been licensed by IOCC to major explosives manufacturers around the world, progress in the marketplace for the first two years was slow. In December 1959 IRECO conducted a test at the US Steel Pilotac operation on the Mesabi Iron Range in northern Minnesota at the request of IOCC to promote the use of slurry in open-pit blasting. The results were so spectacular that a group of IRECO scientists quickly founded a manufacturing and sales company called Mesabi Blasting Agents, Inc, or MBA (in 1960), obtained a sublicense from IOCC, and began to manufacture and sell slurries on the Mesabi Iron Range. Within a year MBA had successfully promoted the use of slurry explosives in the mining industry.

The first-generation slurries were called Dense Blasting Agents, or "DBA's," and comprised two types: slurries sensitized primarily with coarse "Pelletol" TNT and slurries sensitized with aluminum. Second-generation slurries, designated the *IREGEL 300* series, were introduced in 1969 as a replacement for the DBA's except for *DBA-22M*, the first and only slurry yet to be completely qualified by the US Military.

The *IREGEL 300's* were significantly stronger and more water resistant than their *DBA* counterparts by virtue of lower water content, ensured continuity of aqueous oxidizer-

salt solution phase, and better thickening. In 1971 IRECO achieved another first with their introduction of *IREMITE*, a cap-sensitive series of slurry explosives designed for use in small-diameter bore-holes as a replacement for dynamite. These versatile small-diameter products offer distinct safety, fume and performance advantages and are available in a wide range of diameters, densities, and energies and are sufficiently revolutionary in concept to have the same effect in the small-diameter applications as the *SMS* system (see below) did in large open-pit mining

Yet another economically attractive series of slurries called the *IREGEL 600* series was introduced in the US in late 1972. This series is also being manufactured today in Canada, South Africa and Australia

In order to initiate slurry explosives and other modern blasting agents, IRECO Chemicals developed and patented the *Procore* booster—a booster designed for maximum safety with a cap-sensitive core protected by a noncap-sensitive explosive shell comprising cast TNT or composition B. These boosters are characterized by extremely high detonating pressures. Because the booster requirement, as measured, for example, by the minimum booster (*MB*) required to detonate a blasting agent, varies as the reciprocal of the detonation pressure (ie $MB = K/p_2$), *Procore* boosters are very efficient. For instance, the *MB* with a *Procore* booster is much smaller than the *MB* with a gelatin dynamite or low-density (powder) high explosive. "Quickness" (or absence of a transient build-up of detonation) in a booster is another important factor, which is possessed almost ideally by the original "Pentomex" (cast pentolite) and the present *Procore* boosters. *Procore* boosters are used extensively in blasting operations around the world to initiate all types of modern blasting agents. They are manufactured in a wide variety of sizes and weights to meet individual requirements

One of the most significant events in explosives history has been the development of the IRECO Chemicals Site-Mixed-Slurry (*SMS*) system, commonly referred to as the pump truck system, which is today the safest blasting system known. Nonexplosive raw materials are carried by the pump truck from the storage area to the borehole site where they then become an explosive capable

of being detonated after placement in the borehole. By adjusting the settings on the control panel the pump truck operator can deliver a wide range of explosive strengths and densities to meet individual blasting requirements

The first *SMS* system was established for the Kaiser Steel iron ore operation at Eagle Mountain, California. The first *SMS* system outside North America was established in early 1965 at Phalaborwa, South Africa, for the Phalabora Mining Company. Shortly thereafter the *SMS* system was established in rapid succession for mining operations throughout the world

In 1966 fifty percent of the capital stock of IRECO Chemicals was acquired by the Rio Tinto-Zinc Corporation, Ltd, a worldwide association of mining and related industrial enterprises such as ore processing, smelting, fabricating metals, and the production of chemicals. Since that time IRECO Chemicals has continued to grow and is today the world leader in the research, manufacture and marketing of slurry explosives with operations in important mining centers the world over

Written by M. GARFIELD COOK

Irradiation of Explosives with High Speed Particles was studied by Bowden & Singh. They subjected to irradiation a number of sensitive explosive crystals (such as Pb, Ag & Cd azides, Ag acetylide and nitrogen iodide) by electrons, neutrons, fusion products and X-rays. All these substances were exploded by an intense electron stream but it was shown that this was due to a thermal effect. Fission products exploded nitrogen iodide but in the other substances some changes within the crystals took place but no explosions. The experiments showed that, in general, the activation of a small group of adjacent molecules was not enough to cause explosion

Also see articles on Initiation and on Nitrogen Iodide (under Iodides) in this Vol Refs: 1) F.P. Bowden & K. Singh, *PrRoyS A227*, 23-30 & 33-5 (1954) & *CA 49*, 4991 (1955) 2) Bowden & Yoffe (1958) Chapt VII

Iron Acetylide. See Acetylides and Carbides (Inorganic) in Vol 1, p A76-R

Iron Azide. See List of Inorganic Azides in Vol 1, p A543

Iron Picrate. See Picrates

Iron, Powder for Pyrotechnics. Sidorov et al claim a spark-forming composition for ppg fireworks which forms bright sparks of different colors, containing a thermal mixt & a metal powder, eg (%wt): NH_4ClO_4 55 ± 5 , urotopine 14 ± 2 , iditol 8 ± 2 , metal powder (Fe or steel chips, powdered Al or its alloy with Mg) 23 ± 5 (Ref 2)

The use of iron in smoke screens and in signaling compns is claimed by deMent.
Refs: 1) J. deMent, USP 2995596 (1961) & CA 55, 25100 (1961) 2) A.I. Sidorov et al, USSR P 201179 (1967) & CA 68, 61135 (1968) 3) US Spec MIL-I-12058B (Nov 1969), Iron Powder for Pyrotechnics.

Isano Oil. Isano oil, a conjugated triple-bonded glyceride, when heated sufficiently, reacts exothermically with violence. Its uses & chem reactions are described

Ref: J.A. Kneeland et al, JAmOilChemistsSoc 35, 361 (1958) & CA 52, 15096 (1958)

Isazaurolin. (6-Oximino- Δ^2 -dihydro-1,2,4,5-oxtriazin in Ger). (HO.N):C.NH.NH

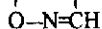

mw 116.08, N 48.27%; mp turns orange ca 85° and puffs off ca $112-113^\circ$ with loud report. Colorless needles which become yellowish on drying and then yellow-orange on storage. Was prepd by Wieland & Hess (Ref 2) by treating methyl azaurolic acid with concd HCl

Dissolves in dil mineral acids (colorless) and in alkalis (orange-red). It is a mild explosive.

Forms salts, as for instance

Hydrochloride. $\text{C}_2\text{H}_4\text{O}_2\text{N}_4 \cdot \text{HCl}$; mp (dec $148-150^\circ$) prisms (from abs alc with small amt of eth); very sol in w; insol in alc

Refs: 1) Beil 27, 783 2) H. Wieland & H. Hess, Ber 42, 4188-89 (1909)

Isoamylamine. See under Amylamine in Vol 1, p A395-R

Isoamylpicrate. See iso-Amylpicrate in Vol 1, p A399-R

Isoamylureidoacetyl Azide. See iso-Amylureidoacetyl Azide in Vol 1, p A399-R

2-Isocyanate Benzoyl Azide. See 2-Azidoformylphenylisocyanate in Vol 1, p A638-R

Isocyanic Acid. See Cyanic Acid in Vol 3, p C582-L

Isobutane. See iso-Butane in Vol 2, p B368-L

Isobutanediol. See iso-Butanediol in Vol 2, p B370-L

Isobutanol. See under Butanol and Derivatives in Vol 2, p B372-R

Isobutyl Alcohol. See under Butanol and Derivatives in Vol 2, p B372-R

Isobutyryl Peroxide. See Di-iso-butyryl Peroxide in Vol 5, p D1201-L

2-Isocyanatobenzoylazide. See 2-Azidoformylphenylisocyanate in Vol 1, p A638-R

Isocyanogen Tetraazide. $(\text{N}_3)_2\text{C}:\text{NN}:\text{C}(\text{N}_3)_2$, mw 220.13, N 89.09%, OB to CO_2 -29.1%, mp 89° . Prepd by reacting tetrabromoisocyanogen, $\text{Br}_2\text{C}:\text{NN}:\text{CBr}_2$, dissolved in Me_2CO with aq NaN_3 . Its use as an initiating explosive is claimed

Ref: C.J. Grundman & W.J. Schnabel, USP 2990412 (1961) & CA 55, 25256 (1961)

Isomelamine. See Cyanuramide in Vol 3, p C589-L

Iso-Me-NENA. Designation of N-(β -Nitroxypentyl)-nitramine or 1-Nitramino-2-propanol Nitrate described in Vol 1, p A253-L

Isomers. Compounds having the same empirical formulas but different molecular arrangement, as well as different chemical and physical properties, are known as isomers

For instance, ortho, meta and para-mono-nitrotoluenes all have the same empirical formula, $C_7H_7NO_2$, but the NO_2 group is attached to different carbons of the benzene ring

Isomers of Trinitrotoluene. Several isomers are known: alpha, beta, gamma, delta, epsilon and zeta (see Trinitrotoluenes, described under Toluene and Its Derivatives)

The most important of these explosive isomers is the alpha-trinitrotoluene, known as TNT. In crude, commercial TNT, 4 to 5% of impurities are present, consisting mainly of a mixture of beta-, or 2,3,4-, and gamma, or 3,4,6-trinitrotoluenes. These impurities may be removed by treating the crude TNT with an aqueous solution of sodium sulfite. According to Davis (Ref 3) the beta- and gamma-isomers react with lead oxide in alcohol to form lead dinitrocresolates, while alpha-TNT remains unaffected under similar conditions
 Refs: 1) M. Copisarow, Chem News 118, 13-14 (1919) & CA 13, 791 (1919) 2) M.M. Kostevitch, Trinitrobenzene & Trinitrotoluene, Paris (1927) 3) Davis (1943) p 147

Isonitramines are compounds having a general formula, $R.N(OH).NO$ or likely

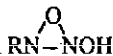

where R stands for a radical, CH_3 , C_6H_5 , $CH_3C_6H_4$ etc. They may be prep'd by treating ketones or nitroparaffins in alcoholic solutions with nitrous oxide (N_2O) in the presence of sodium ethylate

For discussion of the nomenclature of isonitramines see Ref 3

Metallic salts of these compounds were proposed by von Herz to be used in detonators & percussion caps. Lead Methylene diisonitramine is specifically mentioned (Refs 1 & 2)

Refs: 1) E. von Herz, BritP 241892 (1924) & CA 20, 3574 (1926) 2) E. von Herz, USP 1625966 (1927) & CA 21, 2065 (1927) 3) Sidgwick (1937) p 455

Isonitraminoacetic Acid. See Nitrosohydroxy-aminoacetic Acid under Hydroxylamine Derivatives in this Vol

α -Isonitraminoacetoacetic Acid, Ethyl Ester. See 2-(Nitrosohydroxylamino)-3-butanone-1-ic Acid, Ethyl Ester under Hydroxylamine Derivatives in this Vol

α -Isonitraminopropionic Acid. See 2-(Nitrosohydroxylamine)-1-propanoic Acid under Hydroxylamine Derivatives in this Vol

Isöolefin Polymers of molecular wt 50000 to 100000, such as *Isobutylene polymer*, were patented as thickeners for flammable naphtha used in incendiary bomb mixts. Up to 25% may be incorporated. Small amts of metal soaps may replace part of the polymer. Thermit mixts, Na, K and P may also be included in such an incendiary filler
 Ref: H.H. Cooke, E. & J. Holzclaw, USP's 2445311 & 2445312 (1948) & CA 42, 7985 (1948)

Isopicramic Acid. See 2,6-Dinitro-4-aminophenol in Vol 1, p A243-R

Isoprene (2-Methyl-1,3-butadiene) Peroxide, Polymeric. (No formula given). Resinous substance; decomp slightly above 0° . Reported in Ref 2 as a highly explosive substance. May be prep'd by the reaction of isoprene with molecular oxygen

Refs: 1) Beil, not found 2) K. Bodendorf, ArchPharm 271, 1 (1933) & CA 27, 4472 (1933) 3) W. Kern et al, Makromol Chem 3, 223 (1949) & CA 50, 1431 (1956) 4) Tobolsky & Mesrobian (1954) 31 & 178

Isopropyliden-di-cyclohexyliden-triperoxyd. One of the Ger names for the "Acetone Compound" of 1,1'-Bis(hydroperoxycyclohexyl)-peroxide described in Vol 2, p B144-R

Isopurpuric Acid or Picrocyaminic Acid. (or Dicyandinitro-oxy- β -phenylhydroxylamine)

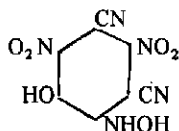

mw 265.14, N 26.42%. It is an unstable compound of dark-yellow color, isolated for the first time by Borsche and Böcker in fairly pure state. It may be prepd by mixing its potassium salt with an ice-cooled aqueous solution of phosphoric acid

The salts of isopurpuric acid are easier to prepare, are more stable and some are explosive, for example:

Potassium Isopurpurate. $C_8H_2O_6N_5K$, mw 303.24, N 23.10%. Brownish-red crystals; may be prepd by adding slowly, with agitation, a solution of 10g of KCN in 40ml of H_2O to 10g of PA dissolved in 170ml of alcohol. The temperature should be kept below 30° . Stirring is continued for a while after completing the addition of KCN and then the mixture is left to stand. After this, the precipitate is filtered off and crystallized from about $1\frac{1}{2}$ l of hot water. The salt is fairly sol in w and easily sol in most organic solvents. It is a violent explosive, very sensitive to impact and friction

It puffs off at 215°

Refs: 1) Beil 15, 61 2) W. Borsche & E. Böcker, Ber 37, 4396 (1904) 3) L. Gody, Traité théorique et pratiques des matières explosives, Namur (Belgium) (1907), p 562 4) Not found in recent CA's

Iso-Trioil. A product resulting from the purification of crude TNT by recrystallization from nitric acid. This process has been used in Europe on a production scale; however, the Sellite purification process was selected for use in the USA. Iso trioil has been found to be a satisfactory substitute for TNT in Dynamite consisting of: RDX 78, TNT 15, cornstarch 5 & polyisobutylene 2% and for DNT in the M-1 Propellant consisting of: NC 84.5, DNT 9.9, dibutylphthalate 4.9 & diphenylamine 1.0%

Ref: J. Cussen, "Utilization of By-Product

Iso-Trioil Resulting from Nitric Acid Purification of Crude TNT", PATR-DB-TR: 16-58 (Jan 1959)

Isotrotyl is a yellow material, mp $57-58^\circ$, containing about 98% of alpha-TNT and its isomers. It is prepd by nitrating the so-called "liquid TNT," containing 16.9-17.4% N with mixed nitric-sulfuric acid. It has been suggested that "isotrotyl" consists of addition compounds of the isomers instead of free isomers. Since the alpha, beta and gamma compounds are practically of the same value as explosives, this low-melting explosive (isotrotyl) was found to be useful as a constituent of blasting explosives, such as Roburite, Bellite etc. It was also used to lower the melting points of other explosives, eg TNX or PA

Ref: 1) M. Copisarow, ChemNews, 118, 13-14 (1919) & CA 13, 791 (1919)

α -**Isoxaloleazide.** See under α -Isoxalolecarboxylic Acid below

α -Isoxazolecarboxylic Acid and Its Explosive Derivatives. $\overline{ON:CHCH:CCO_2H}$; mw 113.07, N 12.39%; pale yel crystals; mp 149° ; bp (loses CO_2 on heating above its mp)

First obtained but not identified by Testoni & Mascareli (Ref 1) from products of reaction between acetylene and fuming nitric acid. Quilico & Freri (Ref 2) prepd it in the same manner and assigned to it the above structural formula

Quilico & Freri (Ref 3) used this acid to prepare the α -isoxazole hydrazide, $\overline{ON:CHCH:CCOHNH_2}$; mw 127.10, N 33.06%, OB to CO_2 -106.8%; mp $141-42^\circ$, which on treatment with $NaNO_2 + HCl$ gave the explosive α -**Isoxazoleazide**, $\overline{ON:CHCH:CCON_3}$; mw 138.09, N 40.58%, OB to CO_2 -73.9%; mp 37° (decomp); bp (explodes violently on heating above its mp) Refs: 1) Testoni & Mascareli, Gazz 32(1), 202 (1902) 2) A. Quilico & M. Freri, Gazz 59, 930-41(1929) & CA 24, 3484 (1930) 3) M. Freri, Gazz 62, 457-63 (1932) & CA 26, 5954 (1932) 4) No further refs found under Isoxazole derivs or Isoxazolecarboxylic acid in CA 1947-1971

Isoxazole Derivatives of Trinitromethane Prepared from Acetylene. In studying the reaction products of nitric acid with acetylene, Quilico isolated an explosive product of yellow color corresponding to the formula $C_4H_2O_7N_6$, mw 246.10, N 34.15%

He assigned to it tentatively the structural formula $\text{ON:CHCH:CN:NC(NO}_2)_3$ and named it α -isoxazoleazotrinitromethane. The compd melts with decompn at 78° , when heated cautiously, but when heated rapidly or struck it explodes with a flame

Refs: 1) Beil 1 {902} 2) A. Quilico, Gazz **62**, 503-18 (1932) & CA **26**, 5953-4 (1932) 3) No other refs found under Isoxazole derivs in CA 1947-1971

4-(3-Isoxazolyl)-3-furazancarboxylic Acid was prepd in complex sequence of reactions by Qualico & Freri (Ref 1). It melts at 133° & decomposes $\sim 190^\circ$

Its Ag salt explodes weakly when heated. (No formulas for the acid or its salt are given) Refs: 1) A. Qualico & M. Freri, Gazz **76**, 3 (1946) & CA **41**, 381 (1947) 2) No further refs found in CA 1947-1971

I_{sp} . Abbreviation for *specific impulse* (sometimes called specific thrust) is the propulsive impulse delivered by a propulsion engine per unit weight of propellant. In the US the units of I_{sp} are lb-sec/lb. It is related to measurable quantities by

$$I_{sp} = [V_e + (P_e - P_a)A_e / \dot{m}_e] / g$$

where the subscripts (e) refer to exit quantities, and the subscript (a) refers to ambient quantities; V = product stream velocity, p = static pressure, A = area, \dot{m} = rate of mass flow & g = gravitational acceleration (Ref 1). Typical values of I_{sp} for "ordinary" systems is 200-270 lb-sec/lb and 270-400 lb-sec/lb for "high-energy" systems (Ref 2). Theoretical calculations of I_{sp} (based on thermodynamics & thermochemistry) are in good agreement with experimental measurements (Ref 3)

Refs: 1) O.E. Lancaster, Edit, "Jet Propulsion Engines," Princeton Univ Press (1959) pp 440-441 2) Ibid, p 453 3) Ibid, pp 464-475 4) Also see articles on *Propulsion*, on *Propellants* & on *Rockets*

IT or IncT. Abbreviation for Incendiary Tracer. See *Incendiary Warfare* in this Vol

ITALIAN EXPLOSIVES AND RELATED ITEMS

Introduction

During WWII, the Italians had several large military explosives and ammunition plants and some of its mining expls plants manufd military expls. They produced materials of good quality and in quantity nearly sufficient to conduct the war:

List of Principal Italian Factories Manufacturing Explosives and Related Items (Obtained thru the courtesy of Dr Omero Vettori, Director of Cheddite Factory, near Aulla (Massa Carrara) (April 1975)

Note: The firms marked with an asterisk are still in production

Section A - Explosives and Propellants

*1) B.P.D. (Bombrini-Parodi-Delfino), now SNIA VISCOSA; factory in Colleferro, near Rome (Production of TNT, Propellants, Hunting Powder and Missiles)

2) ACNA (Aziende Colori Nazionali Affini); factory in Cengio (TNT)

3) SGEM (Società Generale Esplosivi Munizioni); factories in:

a) Carnignano (TNT, Propellants - for cannons and rifles) (destroyed)

*b) Pallerone, near Aulla (Double-Base Propellants) (This factory is now the property of the Italian Army)

c) Villafranca Lunigiana, near Aulla (Propellants for cannons and rifles) (destroyed)

d) Avigliana, near Turin (RDX, PETN, Dynamites and Propellants) (Closed)

e) Bussi e Pratole Peligna (RDX) (destroyed)

4) Unknown Name Firm; factory in Narni (PETN) (This factory is now the property of the Italian Army)

*5) SIPE (Società Italiano, Prodotti Esplosivi); factories in:

*a) Spilamberto, near Modena (NC, PETN, Fuse, Detonating Fuse, Primer & Dynamite)

*b) Galliciano, near Lucca (now called SIPE NOBEL) (Black Powder)

*6) SGEM Factory at Orbetello (now SIPE NOBEL) (Dynamite Detonating Fuse, Industrial Explosives, Blasting Caps, Shell Loading, Detonators)

7) Stacchini, Factory in Saliera Apuana, near Aulla (Black Powder)

8) AFE (Azienda Forniture Esplosivi), Factory in Stazzema, near Viareggio (Black Powder)

*9) Polverificio Benedetto Cocciuti, Factory in Viterbo (Black Powder, Industrial Explosives, Safety Fuse)

*10) Army Factory: Capua (Pirotecnico Esercito) (Caps, Primers, Small Arms Ammunition)

11) Nobel SGEM Factory in Taino, near Varese (Detonators, Blasting Caps, Primers, Fuses, Primary Explosives (now closed))

*12) Army Factory (Spolettificio Torre Annunziata) (Fuze Production)

*13) S.R.C.M. (Società Romana Costruzioni Meccaniche), Factory near Rome (Primary Explosives, Hand Grenades, Caps, Primers)

Section B – Shell Loading Plants:

*1) Army Factories in:

a) Piacenza (exploded in 1940)

b) Noceto, near Parma (Laboratorio Caricamento Proiettili Esercito)

c) Baiano di Spoleto (Laboratorio Caricamento Proiettili Esercito)

*2) Mangiarutti, Factory in Codroipo (Shell Loading, Industrial Explosives, Detonating Fuse)

*3) Ditta Fratelli Rovina, Factory in Spilimbergo (Shell Loading and Unloading)

*4) Ditta Fincati, Factory in Rossano Veneto (Shell Loading and Unloading)

5) Ditta Amelotti, Factory in Rivalta Scrivia (Shell Loading) (Closed)

6) Polverificio Stacchini, Factory in Bagni di Tivoli near Rome (Shell Loading and Loading of Propellants)

*7) B.P.D. (Bombrini-Parodi-Delfino), now SNIA VISCOSA, Factory at Ceccano (Shell Loading)

*8) Sorlini Ing. Antonio, Factory in Ghedi, near Brescia (Shell Loading, Compression of Explosives, Industrial Explosives)

*9) Sorlini Luciano, Factory in Carzago della Rivera (Dynamites, Industrial Explosives, Detonating Fuse, PETN)

10) Ditta Vulcania, Factory in Fascia d'oro, near Brescia (Shell Loading, Industrial Explosives, TNT Purification, Compression of Explosives) (Now closed)

11) Ditta Federico Marzan, Factory in Peschiere del Garda, near Verona (now SAIMA)

(Shell Loading, Shell Manufacture, Mines, Explosives Manufacture) (Now closed)

*12) Ditta Simmel, Factory in Castagnole Paese, near Treviso (Shell Loading, Assembly)

*13) Ditta La Precisa, Factory in Teano, near Naples (Shell Loading, Primary Explosives, Primers, Caps)

*14) Cheddite Italia, Factory in Aulla (Massa Carrara) (Shell Loading, Assembly, Detonating Fuse, Industrial Explosives, such as Cheddites)
Section C – Industrial Explosives

*1) Dinamite S.p.A. (Società per Azione), Factory in Mereto di Tomba, near Udine (Dynamites, DNT, PETN, Industrial Explosives, Detonating Fuse, Blasting Machines)

*2) Pravisani Esplosivi, Factory in Sequals, near Udine (Dynamites and other Industrial Explosives)

*3) SES (Società Esplosivi Siciliana), Factory in Latina (Industrial Explosives)

Section D – Small Arms Ammunition and Weapons

*1) Beretta Armi listed in Catalog

*2) OTO MELARA, Factory in La Spezia (Manufacture of cannons and missiles)

*3) Army Arsenal in Naples, Turin and Piacenza

*4) BREDA MECCANICA BRESCIANA in Brescia (Rifles and Pistols)

*5) Army Factory in Terni (Cannons and other Weapons)

*6) SMI (Società Metallurgica Italiana), Factory in Campotizzoro (Small Arms Ammunition)

7) Leon Beaux (Small Arms Ammunition including 20-mm (Now closed))

*8) Giulio Flocchi Lecco (Small Arms Ammunition)

Italian explosives, ammunition and weapons (small arms and artillery pieces) have always been considered of very good quality. With the exception of T₄ (Cyclonite or RDX) and Tritolita (Cyclotol), which the Italians developed and used before both Great Britain and the USA, there are no high explosives of unusual interest or originality. However, there are several explosives similar to the German Ersatzsprengstoffe (Substitute Explosives), which were developed in Italy due to the shortage of aromatic compounds

In the following pages are listed Italian explosives, some of them obsolete. We are able

to bring the list up to date due to the assistance of Dr Omero Vettori of Aulla (Massa Carrara) and the appearance in 1974 of the monumental work of Dr Camillo Belgrano, "Gli Esplosivi", contg 695 pages. It is the 2nd, greatly enlarged, edition of his 1952 book (Ref 13). The new edition is listed as Ref 31

Alphabetical List of Italian Explosives and Related Items

Acapnia is one of the smokeless propellants, listed in Belgrano (Ref 31, p 581) and by Molina (Ref 1, p 409). See under Polveri da Caccia

Acardite or *asym-Diphenylurea*, described in Vol 1 of Encycl (Ref 24, p A47-R), was developed in Germany under the name of *Akardit*. It has been used, accordg to Belgrano (Ref 31, p 218) as a stabilizer in some Italian smokeless propellants

Accenditori (Lighters) are devices serving to light fuses (micce). In the catalog of Montecatini of 1959, Accenditori "Pirea" Montecatini (p 40) and Accenditori "Dardo" Montecatini (p 41) are described

Accenditori in bacchette (Lighter Rods). Accordg to Belgrano (Ref 31, p 530), it is a fuse of diam 5.5–5.6mm and ca 10cm long filled with a very slow-burning powder contg a finely pulverized mixture of KNO_3 79.00, beech carbon 3.75 & sulfur 17.25%

Accenditori Elettrici (Electric Lighters). A brief description is given in Belgrano (Ref 31, pp 514–15). In catalog of Montecatini of 1959, p 31, are briefly described Accenditori elettrici ritardati (Delay Electric Lighters)

Accenditori Militari (Military Igniters). The following items are described in TM9-1985-6 (1953) (Ref 16):

- a) Chemical Delay Igniter (pp 173–74 with Fig 245)
- b) Time Delay Igniter (Lead Shear Wire) (pp 174–75 with Fig 246)
- c) Friction Delay Igniter–Miccia 40 and 60 (p 175 with Fig 247)
- d) 50-Day Clock (pp 175–76 with Fig 248)

Acido d'argento. See Azotidrato d'argento

Acido azotidrico (Hydrazoic Acid) is briefly described in Ref 31, p 429

Acido nitrico-sulfurico (Nitric-Sulfuric Acid) is described in Ref 31, pp 159–64

ACIDO PICRICO o TRINITROFENOLO

[Picric Acid, abbrd PA or Trinitrophenol (TNPh)], also called in Ital *Melinita o Pertita*, $\text{HO.C}_6\text{H}_2(\text{NO}_2)_3$. Its prepn, props, uses and analytical procedures are described by Belgrano (Ref 17, pp 281–87). Its props are: Density (max) 1.68, Explosion Temperature 310° , Temperature of Explosion 3200° , Heat of Explosion 1040kcal/kg, Volume of gas at 0° & 760mm 675 l/kg, Specific Pressure 8900 atm/kg, Trauzl Test 315cc, Detonation Velocity 7100m/s and Impact Sensitivity with 2kg wt 40cm. Straight PA has been used for loading 100mm, 120mm & 149mm Shells and in composite expls, such as MABT, MAT, MBT, Polvere verde & Victorite (Ref 28, p 318)

Acido di piombo. See Azotidrato di piombo (Lead Azide, abbrd as LA)

Acido stifnico o Trinitroresorcina (Styphnic Acid, abbrd as StA), $(\text{HO})_2\text{C}_6\text{H}(\text{NO}_2)_3$. It is described in Ref 31, pp 453 to 455 and in Ref 28, p 318. Used in the form of its lead salt *Stifnato di piombo* (qv), meaning Lead Styphnate, abbrd LSt

Afocite. A blasting expl compn existing in two formulations: 1) AN (Ammonium Nitrate) 58–62, KN (Potassium Nitrate) 28–31, carbon 7–9 & sulfur 2–3%; 2) AN 58–62, KN 31–38, charcoal 3.5–4.5, sulfur 2–3 & moisture 1.5% (Ref 28, p 318). The 1st formulation is also given by Belgrano (Ref 31, p 340)

Ager (Esplosivi) expls are based on AN (or other inorg nitrates) and aromatic nitro-compounds. Three compns are listed in the catalog of Società Vulcania at Brescia which gives their props & compns with numerical values: *Ager C* – Trauzl test value 320cc & detonation velocity 2800m/s; suitable for use in quarries, with rocks of medium hardness. *Ager D* – Trauzl value 400cc & deton vel 4700m/s; suitable for hard rocks. *Ager E* –

Trauzl value 450cc & deton vel 3823m/s; suitable for work in hard ground. All three expls are nonpermissible (See also Ref 31, p 336)

Albite. A white fusible mixture consisting of AN 60, NGu (Nitroguanidine) 20 & GuN (Guanidine Nitrate) 20%, introduced during WWI by Manuelli & Bernardini and used as bursting chge in some shells (Ref 4, pp 342-44). The compn of Albite used during WWII for loading shells was AN 58.6, NGu 19.1 & GuN 22.3% (Ref 24, Vol 1, p A120-L; Ref 28, p 318 & Ref 31, p 254)

Alfa. Sporting propellant similar to Schultze's smokeless powder (Ref 31, p 581)

Alti esplosive. High Explosives (HE's). See *Esplosivi alti*

Alvisi esplosivi. See *Esplosivi Alvisi*

Amatolo, described in Ref 4, pp 240-41, is similar to Amer or Brit *Amatol* described in Ref 24, Vol 1, pp A158-L to A164-L. Most popular was the mixture "tipo 60/40" (called *Esplosivo 60/40*), which contd AN 60 & TNT 40%. Its deton vel is 6500m/sec, and it was used cast-loaded in shells. Less powerful (deton vel 4500m/s) was "tipo 80/20", which was used press-loaded in sea-mines (Ref 4, p 241). Still less powerful was a 90/10 mixt with deton vel 2500m/s, used in mining operations (Ref 28, p 319 and Ref 31, p 243) (Compare with MNDT, MST and Nougat)

Ammonaftite. Mining expl contg AN 76.7, NG 15.0, Colloid Cotton 0.3 & grain flour 8.0% with 0.5% of yellow ocher incorporated (Ref 31, p 83)

Ammonal, described in Ref 4, pp 237-40, was similar to Austrian, Brit, German, French and Amer Ammonals described in Ref 24, Vol 1, pp A287-L to A292-R. The Ital Army used during WWI the mixture: AN 71-72, Al powder 22 & tar (bitume) 6-7%, under the name *Nitramite* (Ref 4, p 238). Several formulations used during WWII contd AN 46-64, Al 17-22, TNT 15-30 & carbon 3%. Such a compn was known as *Toluol-ammonal* or *T-ammonal*. TNN

(Trinitronaphthalene) was used in some compns in lieu of TNT (Ref 28, p 319 and Ref 31, p 367)

Ammondinamite. See under DYNAMITE

Ammondite. Same as Ammonite No 1

Ammongelatina. See under DYNAMITE

Ammonite No 1. A blasting expl consisting of AN 88, DNT (Dinitrotoluene) 3, NG 3, vegetable flour 5 & DPhA (Diphenylamine) 1% (Ref 28, p 319)

AN-FO (Ammonium Nitrate-Fuel Oil), called in Italy *NA-OC* (Nitrato ammonico-Olio combustibili). Belgrano (Ref 31, pp 318-19) gives a standard compn consisting of "prilled" AN of density 0.70-0.75, 94.4 and combustible oil 5.6%, Trauzl test value 295cc and detonation velocity ca 400m/s

Anigrina lamellare. Single-base smokeless, sporting proplnt with NC completely gelatinized (Ref 31, p 580)

ANS (Esplosivo). Same as ASN

Antifiama (Antiflame or Flame Suppressor) and **Refrigerenti** (Cooling Agents). Belgrano (Ref 31, pp 219-20) lists: vaseline, mineral oils, acardite, NGu (Nitroguanidine), Nitronaphthalene, inorganic chlorides, Amm sulfate, oxalates of Amm, Na & K and K tartrate as cooling agents or flame suppressors for Dynamites

Antigrandine: Esplosivi, Cannoni e Razzi. (Antihail: Explosives, Cannons and Rockets). As bursting charge explosives for antihail projectiles, TNT and some Cheddites were used in Italy. An antihail cannon is illustrated on p 337 of Ref 31, whereas a rocket is on p 626 *Addnl Ref from CA:* L. Peseni, ItalP 518413 (1955) & CA 51, 17170 (1957) (Antihail rockets designed to reach an altitude of 1800m are supplied with BkPdr mixture contg KNO_3 24, charcoal 5 & sulfur 0.65kg)

Antigrisou (Esplosivi) o Esplosivi antigrisutosi (Permissible Explosives). The following are

listed in Ref 31, p 326: *Antigrisou N.0* – AN 80.57, DNN (Dinitronaphthalene) 6.36 & AChI (Ammonium Chloride) 13.02%; *Antigrisou N.2* – AN 81.49, DNN 11.11 & AChI 7.40%; *Antigrisou N.3* – AN 82, TNN (Trinitronaphthalene) 5 & AChI 13%

Requirements for Italian permissible explosives are given by Belgrano (Ref 31, pp 327–29), while tests are described on pp 329–32

Antisanzionite. See ASN

Antonite (Esplosivi). Mining expls manufd by the Società Vulcania at Brescia. Two comps are listed in their catalog of 1960; in Ref 24, Vol 1, p A473-L; and in Ref 31, p 317:

Antonite per cava – for work in quarries – consists of AN & TNT in proportion to make O content 5.9% by weight; Trauzl test value 340cc and deton vel 3400m/s

Antonite per galleria – for work in tunnels – consists of AN & TNT in proportion to make O content 3.08%; Trauzl value 415cc and deton vel 4000m/s

Aquila. A smokeless, sporting proplnt with completely gelatinized NC (Ref 31, p 580)

Ares. A powdery mining expl based on AN & a combustible (Ref 31, p 317)

Aria liquida e Ossigeno liquido (esplosivi).

Liquid Air and Liquid Oxygen Explosives, such as Oxyliquit or LOX have been used in high mountain hydroelectric works by the Ital Corps of Engineers (Genio Militare) (Ref 15, p 38 & Ref 31, p 305)

ARMI PORTATILI MUNIZIONI (Small-Arm Ammunition). The ammunition used during WWII was similar to British and German ammo. The following types are described in TM 9-1985-6 (1953) (Ref 16, pp 65–72): 6.5-mm Ball (p 67, Fig 76); 7.35-mm Ball (p 67, Fig 77); 7.7-mm Ball (p 68, Fig 78); 7.7-mm API (Armor-piercing Incendiary) (Blue Tip) (p 68, Fig 79); 7.7-mm API Incendiary (Green Tip) (p 69, Fig 80); 8-mm Ball (p 69, Fig 81); 8-mm AP (Armor-piercing) (p 70, Fig 82); 12.7-mm Tracer (Red Tip) (p 70, Fig 83); 12.7-mm Incendiary (Blue Tip) (p 71, Fig 84);

12.7-mm APIT (Armor-piercing Incendiary Tracer) (White Tip) (p 72, Fig 85); 12.7-mm HE (High Explosive) (p 72, Fig 86)

In “MUNIZIONAMENTO ITALIANO” (Addnl Ref C) under Cartucce (plural Cartucci) are listed Cartucce Cal 6.5 per Moschetto (Carbine) Mod 91/38; Cartucce Cal 7.35 per Fucile (Rifle) e Moschetto (Carbine) Mod 38; Cartucce Cal 7.65 per Pistola Berretta; Cartucce Cal 8 per Mitragliatrice (Machine Gun) Mod 35 e Breda Mod 37; Cartucce Cal 9 per Mitraflia-trice Mod 38; Cartucce Cal 9 per Pistola auto-matica Berretta Mod 34; Cartucce Cal 10.35 per Pistola Mod 39; Cartucce Cal 13.2 per Mitragliera d’Aereo (Aerial Machine Gun)

Actually *cartucci* are complete rounds of small-arms ammunition, while *cartocci* are complete rounds of artillery ammunition

Armi subacquee (Underwater Weapons). They include: *siluri* (submarine torpedoes), *bombe torpedini di profondità* (depth bombs), *mine subacquee* (underwater mines), etc. Their *teste* (warheads) can have as bursting charge (*carica esplosiva*) *Tritolital* (TNT 60, RDX 20 & Al 20%); *Tritolito* (RDX 40 or 60 incorporated in fused TNT 60 or 40%) or *Torpex* (RDX 44, TNT 38 & Al powder 18%) (Ref 31, p 382)

Artifici da guerra – Military Pyrotechnics. See under PIROTECNIA

ARTIGLIERIA ITALIANA – Italian Artillery

Its history is described in the book of General Carlo Montu (Ref 3). Artillery pieces used during WWI & WWII are described by the late Col J.B. Jarrett in Ref 5a (illustrated)

It would be well to remember that Italian practice is to refer to the caliber in millimeters followed by the tube length in calibers. Thus, 65/17 means a 65-mm bore diam and a tube 17 calibers long

Following Chart is copied in abbreviated form from Ref 5a, p 668

CHART I
Breakdown of Important Data Concerning the Most Used Italian Pieces

<u>Designation</u>	<u>MV</u> (ft sec)	<u>Range</u> (yds)	<u>Ammunition</u>
65/17	1,140	7,100 ±	HE, AP-HEC&BC, Hollow chge
75/13	1,240	9,000	HE, AP-HEC&BC, Shrapnel
75/18, Model 34	1,300	10,300	HE, AP-HEC&BC, Shrapnel, Hol chge
(This piece was found on 3 carriage models, and was also used on the Semovente or S.P. M13/40 tank version)			
75/27, Model 11	1,640	11,100	HE, AP-HEC&BC, Shrapnel, Hol chge
(A modification of this weapon was seen on S.P. carriages)			
75/34	1,650	13,500	HE, AP-HEC&BC, Hollow chge (streamlined shells)
77/28	1,762	7,300	HE, shrapnel and case shot
(Originally Krupp 1896 design)			
100/17, Model 14	1,400	10,100	HE Shrapnel, Hollow chge
105/28	1,880	15,000	HE (several patterns flatbased and streamlined)
149/12, Model 14	1,100	7,500	HE and Shrapnel (several patterns of HE)
149/13, Model 14	1,100	9,600	HE and Shrapnel (several patterns of both)
149/17	1,660	12,500	HE, Shrapnel (several patterns)
149/40 (Modern gun)	2,600	23,900	HE (2 patterns)
152/13 Howitzer	1,300	10,400	HE (several patterns)
152/37	2,270	21,800	HE (several patterns)
210/22	1,870	17,400	HE and an AP (likely anti-concrete)
(Not seen in Africa)			
305/8	1,300	12,000	HE (base fuzed and Shrapnel)
(Skoda mortar 1916 and not seen in Africa)			

Antiaircraft Artillery (AA Guns)

		<u>Vertical</u> <u>Range</u> (feet)	
2-cm Breda	2,755	7,000	HE, SD and AP
2-cm Scotti	2,720	7,000	HE, SD and AP
37/54 Breda	2,620	13,500	HE - time fuzed HE - PD fuzed
75/27 Krupp	1,500		HE and AP
75/46 Ansaldo, Model 34	2,350	27,200	HE and AP
75/50 Skoda	2,690	30,000	HE
75/53 French, Model 30	2,280	31,000	HE
76/40 Ansaldo	2,460	31,000	HE
90/53 Ansaldo	2,500	39,300 (?)	HE and AP

Following addnl info is taken from p 669 of Ref 5a:

CHART II

Antitank (A/T Guns)

47/32	Breda
47/32	Austrian Boehler
47/50	Schneider (French captured)
75/27	Series, using AP, Hollow charge
75/46	AA Dual purpose
90/53	AA Dual purpose
100/17	series, using AP, Hollow charge

Seacoast Guns

57/30	
57/43	
120/21	} Same ammunition
120/25	
120/40	
149/35	
152/32	} Same ammunition
152/50	
280/9	(two versions)
280/10	} Same ammunition
280/11	
280/16	
305/17	
305/50	
381/40	
420/12	

Abbreviations:

AP	= Armor-piercing
A/T	= Antitank
HE	= High Explosive
HEBC	= High Explosive, Ballistic Cap
HEC	= High Explosive, Capped
Hol chge	= Hollow (or Shaped) Charge
PD	= Point Detonating Fuze
SD	= Self-destroying
SP	= Self-propelled

Note: In the opinion of Col G.B. Jarrett, the Italian artillery support to other arms performed poorly during WWII, even though the Italian gunners were usually very brave men. Briefly, their troubles lay in poor design of both carriages and ammunition (Ref 3, pp 663-64) (See also CANNONE)

ASN (Antisanzionite) o Esplosivo ASN (Called **ANS** in Ref 31, p 181). A castable AN expl compn contg DCyDA (Dicyandimide) for lowering the mp of AN. Compn of a filler for ar-

tillery projectiles used during WWI was: AN 65, TNT 20, Na nitrate 10 & DCyDA 5% (Ref 4, p 244)

ASN of Tonegutti, proposed after WWI consisted of AN 70, PETN 20 & DCyDA 10%. It melted at 115° and was suitable for cast-loading shells (Ref 4, p 245 & Ref 24, Vol 1, p A496-L).

ASN of Tonegutti, proposed before WWII, consisted of: AN 60, PETN 20, DCyDA 10 & GuN (Guanidine Nitrate) 10%. It has a low mp (104°) due to the presence of DCyDA & GuN. It was used during WWII for loading Naval shells. When used in underwater ammunition, such as torpedoes, depth charges & sea mines, its efficiency was increased by incorporating some Al powder (Ref 28, p 320 and Ref 31, p 181 under Antisanzionite)

Aster. A smokeless, sporting propint with NC completely gelatinized (Ref 31, p 580)

Astralite 1 e 2 were Ital AN+TNT+NG+woodmeal expls manufd during WWI by the Società Dinamite Nobel, Avigliana (Ref 15, p 32). They were used as fillers for trench mortar shells and hand grenades. The expls were similar to German Astralits listed in Ref 24, Vol 1, pp A497-R & A498-L. Belgrano (Ref 31) lists on p 122 the ballistic mortar strength of *Astralit antigrisou 3^e classe* as 4.75% of Gelatina 92/8 (Sprenggelatine), but gives no compn

Accdg to Ref 28, p 320, Astralites are now used in mining operations

Avigliana 3. See Nitramite

Azotidrato d'argento (Silver Azide—SA) o **Acido d'argento**, AgN₃, is described in Belgrano (Ref 31, pp 449-51). Trauzl value for 2g sample 22.5cc, Detonation Velocity 5700m/sec, Temperature of Explosion 3545° & Detonation Temperature 297° (Ref 31, pp 447 & 451). Small quantities of SA are used in primers (Ref 28, p 318) (See also Ref 24, Vol 1, p A597-R to A601-R)

AZOTIDRATO DI PIOMBO (Lead Azide—LA) o **Acido di piombo**, Pb(N₃)₂, is described by Belgrano (Ref 31, pp 439-49). Its props are: Density (max) 4.79, Explosion Temperature

327°, Temperature of Explosion (Flame Temperature at Explosion) 3350°, Specific Volume 310 l/kg, Heat of Formation -364kcal/kg, Impact Sensitivity with 2kg wt 8cm, Trauzl with 10g sample 115cc and Detonation Velocity 5300 m/sec. It was manufd by Nobel SGEM at Tiana, near Torino and by Bombrini-Parodi-Delfino SA at Colloferro-Roma. LA nearly entirely replaced MF (Mercuric Fulminate) as an initiating detonating agent of priming compns. It can be used alone but is preferable to use it with LSt (Lead Styphnate) which is more sensitive to flame initiation (Ref 28, p 318) (See also Ref 24, Vol 1, pp A545-L to A563-L)

Balistine (Ballistite). A double-base propellant with high NG content was invented in 1887-1888 by A. Nobel. Several formulations were developed later and used in many countries. The varieties used in Italy are listed in Ref 24, Vol 2, pp B8-R & B9-L. *Balistine al 60*, which contd NG 60 & NC 40% with 1-2% stabilizer added, was too erosive for use as a proplnt in guns, but proved to be very suitable for use as a bursting charge in some smaller caliber shells, such as 37/40mm HE and 37/40mm HEAP (High-Explosive Armor-Piercing)

Belgrano (Ref 31,) lists on p 205: *Balistine ordinario* contains NG 50 & CC (Cotone colloidio) 50%; *Balistine a basso titolo* cont NG 42 with CC & other ingredients; *Balistine attenuata* cont NG 25, Pirocollodio 60 & liquid DNT 15%. Every compn contained ca 0.5% DPhA (Diphenylamine) added (See also Ref 4, p 181)

Bassi esplosivi. See *Esplosivi bassi*

Bersaglio. Target

Bicchiere. Projectile's Case or Body. See PROIETTO o PROIETTILE

Blasting Gelatin. See *Gomma A*

BM (Esplosivi Mangiarotti). A series of mining expls manufd by the Società Mangiarotti, Codroipo (Udine). The following formulations are listed in their catalog of 1960:

BM. 1. per galleria - gray powder consisting of TNT, AN & thermit; Trauzl test value 440cc

& deton vel 3550m/sec; used in galleries not contg firedamp

BM. as. per uso a cielo aperto - reddish pdr consisting of AN, with cyclic aliphatic compds & metallic pdrs; Trauzl value 470cc & deton vel 4100m/sec; used in open-cut quarries with rocks of medium hardness

BM. ac. per uso a cielo aperto - brownish-yel pdr consisting of AN & TNT; Trauzl value 450cc & deton vel 3800m/sec; used in open-cut quarries

BM. 57. per uso a cielo aperto - grayish-black pdr based on AN; Trauzl value 370cc & deton vel 2050m/sec; used in open-cut quarries with materials of medium hardness, such as limestone, clay, soil for cement, etc

Super BM. per galleria - green pdr, sl plastic contg aromatic nitrocompounds with org nitrates and plasticizers; Trauzl value 420cc & deton vel 5000m/sec; used for blasting in galleries contg no firedamp

BM. a2 - brown pdr contg AN, TNT & thermit; Trauzl value 440cc & deton vel 3000m/sec; used in open-cut quarries with soft & medium hard rocks; also in agriculture, such as for destruction of tree stumps, etc

Super BM. Cava - gray pdr of density 1.20; compn not given; Trauzl value 510cc & deton vel 4600m/sec; used in quarries for blasting very hard materials such as granite

BM. 2 per galleria - gray pdr contg inorganic nitrate, org nitrocompounds and Al pdr; Trauzl value 450cc & deton vel 4100m/sec; used in gallerias contg no firedamp

Note: BM is mentioned in Ref 31, p 317 w/o giving compn or props

Boceda. Sporting smokeless proplnt with completely gelatinized NC (Ref 31, p 580)

Bomba atomica is briefly described by Belgrano (Ref 31, pp 519-20). General description is given by C.G. Dunkle in Ref 24, Vol 1, pp A499-L to A500-L. Historical development is discussed on p A500-L, under "Atomic (or Nuclear) Energy"

BOMBA (plural Bombe) - Bomb (Bombs), Conventional

Italian bombs of WWII are described in OP 1668 (Ref 8, pp 1-27) and in TM 9-

1985-6/TO 39B-1A-8 (Ref 16, pp 1-27). They were constructed of more than one piece, being assembled by screws or rivets, or welded. They were usually filled thru the base, which was closed by a base plate, attached by screws or rivets. The bombs were generally constructed of sheet steel but in some cases aluminum alloy was used. Demolition bombs were usually constructed of mild steel, while armor-piercing bombs (AP) were made of hardened steel. The anti-personnel (A/P) bombs differed from demolition bombs in construction; in one type (Type F) the filling was enclosed in a sheet container, on the outside of which a steel strip was wound spirally, while in another type (Type Mtr) the filling was contained in a sheet-steel case which was enclosed in a larger container. The space between the two containers was filled with steel fragments

The majority of bombs contained tail fuzes but quite a number contained nose fuzes. Some medium and large bombs, eg, 100, 250, 500, 800 and 1000 kg, contained both tail and nose fuzes

The principal bomb filling was cast Tritolo (TNT); however, quite a few bombs were filled with Amatol; and, in the case of shaped-charge bombs, with a mixture of T₄ (RDX) 60, TNT 38 & wax 2%

The bombs were either galvanized or painted to protect them from corrosion. The following colors were used to identify different types:

Type of Bomb	Color of	
	Body	Nose
Fragmentation (F)	Blue	Red
High Explosive (HE)	Grey	Red
Anti-personnel (A/P)	Black or Blue	Red
Incendiary (IB)	Reddish-brown	Red
Gas (G)	Bright Yellow	Red
Practice	Grey	Grey

Following are Italian terms for bombs and for some grenades:

Bomba a mano	Hand grenade
Bomba a mano contro i carri armati	Anti-tank grenade
Bomba a mano dirompente	Fragmentation grenade
Bomba antisommergibile; (bomba da getto; bomba di profondità o bomba torpedine)	Depth bomb or depth charge
Bomba da demolizioni	Demolition bomb
Bomba da tromboncino	Rifle grenade
Bomba dirompente	Fragmentation bomb
Bomba fumogena	Smoke bomb
Bomba incendiaria	Incendiary bomb
Bomba leggiera	Illuminating bomb
Bomba luminosa	Flash bomb
Bomba perforante	Armor-piercing bomb
Granata bomba	Demolition bomb
Bomba da esercitazione	Practice bomb

Table

**Listing Names, Dimensions, Explosive Charges and
Fuzes Used in Italian Bombs of WWII**

American Designation of Bombs	Italian Designation of Bombs	Overall Length (inches)	Maximum Diameter (inches)	Type of Filling	Weight of Filling (kg)	Total Weight (kg)	Fuze
2 kg A/P	F	6.0	4.5	TNT	0.380	1.72	Tail, Type K
2 kg A/P	Mtr	6.0	4.5	TNT	0.220	1.87	Tail, Type K
3 kg A/P	Mtr	12.1	8.2	TNT	0.17	3	Nose, Type M
4 kg A/P	Manzolini (Thermos)	12.3	7.3	TNT	0.67	3.68	Manzolini Types I & II
12 kg A/P	F	32.4	17.3	TNT	1.93	12.20	Nose, Type F
12 kg A/P	Mtr	3.5	3.5	TNT	1.90	12.88	Nose, Type J
14 kg Frag	I	22.1	4.2	TNT	2	14	Nose, Type I
14 kg Frag	II	22.1	4.2	TNT	2	14	Nose, Type I
24 kg GPHE	—	30.5	6.4	TNT	12	24	Tail, Type N-1
40 kg GPHE	—	32.3	9.0	TNT	Unknown	40	Tail, Type N-3
50 kg GPHE	—	40.5	9.9	Amatol	29.20	59.31	Tail, Type C or Y
100 kg GPHE	—	51.3	10.7	TNT	50.6	100 (appr)	Tail, Type C or Y
100 kg GPHE	—	51.3	10.7	Amatol	49.5	100 (appr)	Tail, Type C or Y
250 kg GPHE	—	73.8	17.6	TNT	125.7	259.1	Nose, Type A and Tail, Type O
500 kg GPHE	—	96.6	18.0	TNT	216	508	Nose, Type A and Tail, Type O
800 kg GPHE	—	127.8	18.0	Unknown	357	821.6	Nose, Type A and Tail, Type O
1000 kg GPHE	—	140.0	20.5	TNT	Unknown	1000 (appr)	Nose Fuze Only
500 kg GPHE	—	93.7	18.1	TNT	247.0	Unknown	Nose and Tail Fuzes
Time Bomb	—	—	—	—	—	—	—
15 kg SAP	—	31.0	4.7	TNT	5.2	15.5	Tail, Type N
31 kg SAP	—	31.7	6.4	TNT	10.5	31.0 (appr)	Tail, Type N-2
100 kg SAP	—	50.5	9.9	Amatol	27.3	109.0	Tail Fuze, Type C-1 or Y-1
104 kg SAP	—	43.0	10.0	TNT	30 (appr)	104.0	Tail, Type C
12 kg Sm	—	47.0	5.2	Sm compn	—	28	Nose Fuze
0.5 kg Inc	IP	6.1	2.75	Cotton wicks soaked in gasoline	—	0.5 (appr)	Tail, Type K
0.5 kg Inc	IT	5.1	2.5	Thermite	—	0.5 (appr)	Tail, Type K
0.5 kg Inc	FI	4.9	2.5	Phosph	—	0.5 (appr)	Tail, Type K
1 kg Inc	I & II	6.1	2.7	Mg powd Thermite	0.084 0.473	1 (appr)	Tail, Type K

(Continued)

Table (Italian Bombs) (Continuation)

American Designation of Bombs	Italian Designation of Bombs	Overall Length (inches)	Maximum Diameter (inches)	Type of Filling	Weight of Filling (kg)	Total Weight (kg)	Fuze
2 kg Inc	I	12.2	2.7	Thermite Oil	0.321 0.339	2.12	Tail, Type K
2 kg Inc	II	12.2	2.7	Mg, HgO & MNB	Unknown	Unknown	Tail, Type K
20 kg Inc	—	34.0	6.3	Thermite	10.58	20.17	Tail, Type E
70 kg Inc	—	47.2	9.9	Thermite	36.6	74.5	Tail, Type E
100 kg Spec (Combination A/P bomb & bomb container)	—	532.0	10.7	TNT	Unknown	113.0 or 82.1	Nose, Type X & Tail, Type Z
15 kg Gas	—	31.0	4.7	DPhClAr TNT (burster)	3.65 1.7	16	Tail Fuze
25 kg Gas	Furretta	32.7	6.3	Lacrym	10.0	25	Tail, Type K
40 kg Gas	(C40 P)	32.3	9.9	DPhClAr Burster	6.5 13.0	47	Tail Fuze
40 kg Gas	(C40 P)	32.3	9.9	Mustard Burster	14.7 0.18	40.6	Tail Fuze
55 kg Gas	—	32.3	9.8	Phosgene Burster	20 18	55	Unknown
100 kg Gas	(C100 P)	50.2	10.7	DPhClAr Burster	14.3 28.7	101.9	Tail Fuze
250 kg Gas	—	Unknown	18.0	Mustard	214	264 (appr)	Nose Fuze
500 kg Gas	(500T)	96.6	18.0	DPhClAr	210	298	Nose, Type T
5 kg Vento -Marker(a)	—	17.4	5.2	Sm or Inc	Unknown	5.2	Nose, Type S
160 kg A/S	(CS)	69.8	13.3	TNT	99	176	Nose & Tail Fuzes
160 kg HE	—	62.4	12.6	TNT	Unknown	163.5	Nose Fuze
3 kg AA	(CV)	13.5	3.2	Amatol	0.40	3.0	Nose, Type I
20 kg AA	(CV)	30.7	5.5	Unknown	Unknown	Unknown	Nose, Type I
3.5 kg HoC	—	18.8	6.0	RDX 60 TNT 38 Wax 2	22	3.5 (appr)	Tail Fuze
5 kg HoC	—	Unknown	Unknown	Unknown	Unknown	Unknown	Tail Fuze
25 kg HoC	—	Unknown	Unknown	Unknown	Unknown	Unknown	Tail Fuze
50 kg HoC	—	Unknown	Unknown	Unknown	Unknown	Unknown	Tail Fuze
100 kg HoC	—	Unknown	Unknown	Unknown	Unknown	Unknown	Tail Fuze
Bomb Container (b)	—	5'6"	11	AP or Inc	Unknown	23 (empty)	—
Parachute Flare	Martellona	36.9	4.0 (appr)	Mg (powder)	Unknown	Unknown	Nose, Type L
Parachute Flare (cardboard)	—	12.5	1.45	Unknown	Unknown	Unknown	Friction Igniter for Nose

Abbreviations: **AA** Antiaircraft; **AP** Armor-piercing; **A/P** Antipersonnel; **appr** approximately; **A/S** Antisubmarine; **C, CS and CV** Italian designations for bombs; **Compn** Composition; **Design** Designation; **diam** diameter; **DpHClAr** Diphenylchloroarsine; **F** Ital designation (See note c); **Frag** Fragmentation; **GP** General purpose; **GPHE** General purpose high explosive; **HE** High Explosive; **HoC** Hollow (shaped) charge; **Inc** Incendiary; **Lacrym** Lacrymator; **MNB** Mononitrobenzene; **Mtr** Italian designation (see note d); **Phosph** Phosphorus; **SAP** Semi-armor-piercing; **Sm** Smoke; **Spec** Special

Notes:

- a) The Vento Marker was used in conjunction with chemical bombs to indicate the force and direction of the wind at ground level. Two fillings were used, a smoke filling in the daytime and an incendiary filling for use at night
- b) The Bomb Container was a bomb-shaped hollow body of sheet metal, holding 8 columns of A/P or incendiary bombs
- c) "F" Bomb consisted of a thin steel cylinder surrounded by a tightly coiled spring of rectangular cross section. The object of the spring was to provide shrapnel effect. In fragmentation, the bomb usually broke into pieces about 1" x 0.2" x 0.18"
- d) "Mtr" Bomb consisted of two cylinders of sheet metal. The inner cylinder contained the explosives, and the outer cylinder was threaded at the top to take a screwed circular cover. Between the two cylinders were small steel pellets embedded in concrete

Bomb Fuzes – Spolette per bombe

Italian Bomb Fuzes used during WWII were mechanically operated, except for Time Fuzes (Spolette a tempo) used in 500-kg Time Bomb. Most of the fuzes functioned on impact. Normally the fuzes were made of brass, steel or Al and were coated with shellac or varnish to prevent corrosion. Both nose and tail fuzes were used

Technical Manual TM 9-1985-6 (Ref 16) lists twelve types of MINF (Mechanical Impact Nose Fuzes) (pp 29–39); nineteen MITF (Mechanical Impact Tail Fuzes) (pp 40–49 & 54–55); three MTNF (Mechanical Time Nose Fuzes) (pp 49–50); one ETNF (Electrical Time Nose

Fuze) (p 51); one CLDNF (Clockwork Long-Delay Nose Fuze) (p 52); one CLDTF (Clockwork Long-Delay Tail Fuze) (p 53); one Tail Fuze for Hollow Charge Bomb (p 56); one Hydrostatic Tail Fuze—"Grand Daddy" (p 57); one MINF—"Orphan" (p 58); and one Mechanical Anti-Disturbance Fuze—"Manzolini" (pp 59–60)

Italian terms for Fuzes are given under Spoletta (plural Spolette)

Booster Charge. See Carica di rinforzo

Borani – Propellenti liquidi per razzi (Liquid Rocket Propellants) consist of liquid hydrogen with boron or other light element, such as beryllium (Ref 31, p 129)

BOSSOLO (plural **Bossoli**). Accdg to the "Military Dictionary", listed here as AddnlRef A, it can be translated as *Cartridge Case, Shell Case or Shrapnel*. This signifies that the term bossolo has several meanings and the same conclusion can be drawn after reading the following:

Belgrano (Ref 31, p 611) describes only **bassoli da caccia** which are cardboard or plastic *cartridge cases* used in sporting (hunting) ammunition

Accdg to "MUNIZIONAMENTO ITALIANO", listed as AddnlRef C, **bossoli** for small arms' ammunition are cartridge cases, usually made of brass, provided with percussion primers at their base. These bossoli serve as containers for propelling charges (*cariche di lancio*). In case of fixed or semi-fixed artillery ammunition, such as for *granata perforante* (armor-piercing shell), bossolo is a brass tube located inside a *cartridge case* and attached at its perforated base to a percussion primer. The bossolo is loaded thru its upper open end with an easily ignitable mixture, usually Black Powder (*polvere nera*, abbrd as **p.n.**), which serves to ignite on striking the percussion primer with a trigger, the propelling charge (*carica di lancio*) in the cartridge case. This type of bossolo may be called a **Powder Tube** or an *Igniter Tube* (Compare with *Igniter Tubes* described in Ref 24, Vol 1, p A385-L and in Vol 2, p C75-R) (See also under **CARTOCCIO**)

Burster Charge. See Carica di scoppio

C (Polvere). A smokeless propellant with NC of 12.5% N completely gelatinized with ether-alcohol (Ref 31, p 580). Do not confuse with *Miscela C* (qv)

C-2 (Polvere) o Cordite Italiana. A double-base proplnt manufd by Società Dinamite Nobel at Avigliana for use during WWI and WWII. Its compn as given in Ref 31, p 210 is NC 70.5, NG 23.5, vaseline 5.0 & Na bicarbonate 1% (See also Ref 4, p 179)

C-12 (Polvere). Ital solventless proplnt: NC 68.0, NG 25.0, Centralite 5.0, vaseline 1.0, Na bicarbonate 0.5 & Amm oxalate 0.5% (Ref 4, p 183)

CG-13 (Polvere). See Polvere CG-13

CG-14 (Polvere). See Polvere CG-14

Cadinite. A mining expl consisting of Na nitrate 56, NG 26, sulfur 10 & carbon (or a celluloic material) 8% (Ref 8, p 321)

Cannel (Polvere). See Polvere Cannel

CANNELLO (plural **Cannelli**). Accdg to Military Dictionary (AddnlRef A), it is not a *Cannon Primer*, but it is rather a *Projectile Primer*.

The following types exist:

Cannello elettrico – Electric Primer

Cannello a frizione – Friction Primer

Cannello fulminante – Igniter

Cannello fulminante a strappo – Pull Igniter

Cannello fulminante a pressione – Push Igniter

Cannello a percussione – Percussion Primer

Accdg to AddnlRef C, the *cannello* is a part of the *colpo completo* (Complete Round of Ammunition)

CANNONE (plural **Cannoni**). Accdg to Military Dictionary (AddnlRef A), it can be translated as Cannon, Gun or Piece (of Artillery)

They may be subdivided into:

Cannone ad anima liscia – Smoothbored Cannon

Cannone ad avancarica – Muzzle-loading Gun

Cannone antiaerea – Antiaircraft Gun

Cannone anticarro – Antitank Gun

Cannone a retrocarica – Breech-loading Cannon

Cannone a tiro rapido – Rapid-fire Gun

Cannone automatico – Automatic Gun

Cannone contro i carri armati – Antiarmored Vehicle Gun

Cannone da campagna – Field Gun; Field Piece

Cannone da carro armato – Armored Vehicle Gun; Tank Gun

Cannone da costa – Coast Artillery Gun

Cannone da esercitazione – Drill Gun

Cannone da montagna – Mountain Gun

Cannone d'assedio – Siege Gun

Cannone di grosso calibro – Heavy Gun

Cannone di piccolo calibro – Light Gun

Cannone di torre corazzata – Turret Gun

Cannone fuori bord – Out-board Gun (Avn)

Cannone per fanteria – Infantry Gun

Cannone rigato – Rifled Gun

Cannone seudato – Shielded Gun

CAPSULA (plural **Capsule**). Capsule or Percussion Cap

Capsula detonante – Blasting Cap or Detonator

Capsule incendive ad accensine elettrica –

Electric Igniter Cap consisted, accdg to Piantanida (Ref 4, p 196), of a mixture of Guncotton (dry) 50, $KClO_3$ 25 & Sb_2S_3 25%, which surrounded the Pt-Ir wire, connected to two electrodes

Capsule incendive a percussione – Percussion

Caps for igniting propellant charges consisted, accdg to Piantanida (Ref 4, pp 194–95), of mixtures of MF, $KClO_3$, Sb_2S_3 , glass powder & gumlac. Less expensive mixture contd $KClO_3$, Sb_2S_3 & gumlac or $KClO_3$, $Pb(SCN)_2$ & Pb ferrocyanide. Numerical values and other compns are listed on pp 195–196. These mixtures are probably obsolete

CARICA (plural **Cariche**) – Charge

Carica cave o Carica ad effetti concentrati –

Hollow or Shaped Charge. In the Catalog of the Società Mangirotti, Codroipo (Udine), published in 1960 are described on p B5 compressed charges of TNT (Tritolo). They are in the shape of inverse funnels with inside cavity to create the Munroe-Neumann Effect action on detonation initiated by a cap. The bottom diameters of chges are 60 & 75mm and their weights are 80, 100, 120, 160, 230, 300 & 360g. Their intended uses are demolition of

large blocks of stone & punching holes thru steel plates

A brief, general description of *cariche cavi* (including an illustration; Fig 77) is given by Belgrano (Ref 31, pp 267-69)

Carica d'inflamazione — Igniting Charge

Carica d'innescamento — Priming or Initiating Charge. Their compositions are listed under *Composizioni (o Miscele) innescanti*

Carica di lancio — Propelling Charge. See under **ESPLOSIVI DA GUERRA**. Accdg to AddnlRef C; it is a part of the *colpo completo* (qv)

Carico di polvere nera — Black Powder Charge

Carica posteriore — Base Charge

Carica preparata — Prepared Charge with Container; Cartridge

Carica di rinforzo — Booster Charge. See under **ESPLOSIVI DA GUERRA**

Carica di scoppio — Bursting Charge. See under **ESPLOSIVI DA GUERRA**

Carlsoniti. Perchlorate based expls, such as
a) $KClO_4$ 85 & vaseline 15% and
b) $KClO_4$ 88 & DN Benzene 12% (Ref 31, pp 362-63)

CARTOCCI (singular **Cartoccio**) (Propellant Containers or Cartridge Cases). The description given in "MUNIZIONAMENTO ITALIANO" (AddnlRef C) is incomprehensible without

illustrations, and for this reason we are including here two Figs from the article of Col Jarrett, listed here as Ref 5a. The 1st Fig is **cartoccio a bossolo** (Cartridge with Igniter Tube), while the 2nd Fig is **cartoccio a sacchetto** (Cartridge Bag). The illustrations in Jarrett's article include *cartocci a bossolo* for 75mm Shell and also for 105/28, 100/17 and 149/13 Shells

In **TM 9-1985-6** (1953), listed here as Ref 16 are described and illustrated under *Cartridge Cases*, without including Italian names, the cases for several weapons. Their *igniter charges* range from 10 to 50g of Black Powder

Cartridge Cases for the following weapons are described and illustrated: 75/13-mm Mountain Gun (p 123, Fig 185); 75/18-mm Mountain Howitzer (p 124, Fig 186); 75/27-mm Field Gun (pp 124-25, Fig 187); 75/32-mm Light Field Gun (p 125, Fig 188); 77/28-mm Field Gun (p 126, Fig 189); 100/17-mm Light Field Howitzer (p 126, Fig 190); 105/14-mm Light Field Howitzer (p 127, Fig 191); 105/28-mm (p 127, Fig 192); 149/13-mm Heavy Field Howitzer (p 128, Fig 193); 149/13-mm Field Howitzer (p 129, Fig 194); 152/37-mm Gun (p 130, Fig 195); 380/15-mm Heavy Howitzer (p 131, Fig 196)

CARTOCCI GRANATA. Under the title, "MUNIZIONAMENTO ITALIANO" (Addnl-Ref C) are listed complete rounds (*colpi completi*) for weapons caliber 20-mm and larger, which for small arms, the corresponding rounds are listed as *cartucce* under *armi portatili*

For example *Cartocci Granata per Mitragliera* (Machine Gun) *da 20-mm Mod 35* consists of *bossolo e cannelo* (Cartridge Case with Primer), *carica di lancio* (Propelling Charge), *bicchiere* (Projectile Body), *carica di scoppio* (Bursting Charge) and *spoletta* (Fuze). *Bossolo* is of brass and is filled with *polvere FC 4*. *Bicchiere* is of steel with copper bands and filled with TNT or flegmatized RDX or PETN

Other *cartocci granata* described in Addnl-Ref C are:

Cartocci Granata per Mitragliera da 37/54, Mod 39

Cartocci Granata per Cannone da 47/32

Cartocci Granata per Obici (Howitzers) da 75/13, Mod 32

Cartocci Granata da 75/27 per Cannone, Mod 32

Cartocci Granata per Cannone da 76/40-45, Mod 36

CARTOCCIO A BOSSOLO
SCALA 1/2

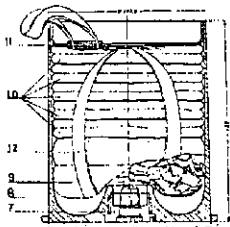

Cartridge with Igniter Tube

CARTOCCI A SACCHETTO
PER CANNONE DA 75/13
SCALA 1/6

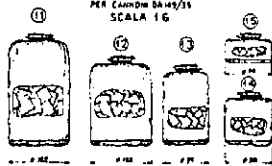

Cartridge Bag

Cartocci Granata per Cannone de 90/53
 Cartocci Granata per Obice da 100/17, Mod 14-50
 Cartocci Granata per Obice da 100/22
 Cartocci Granata per Cannone da 105/28, Mod 32
 Cortocci Granata per Obice da 149/19, Mod 32
 Cartocci Granata per Cannone da 149/40, Mod 35
 Colpi completi (Complete Rounds) per Obice da 210/22

Colpi completi per Mortaio da 81-mm

Colpi completi per Mortaio da 120-mm

Cartridges from 6.5mm to 12.7mm, incl, are listed under *Armi Portatili, Munizioni* (Small-Arms Ammunition), while artillery cartridges of caliber 37mm and higher are listed in MUNIZIONAMENTO ITALIANO as *cartocci granata* and described in TM 9-1985-6 (1953) (Ref 16). From Ref 16, we are listing here:

37/40-mm HE (p 73, Fig 87); 37/40-mm HE/AP (p 73, Fig 88); 37/45-mm AP (p 74, Fig 89); 37/54-mm AA (p 74, Fig 90); 40/39-mm AA (p 75, Fig 91); 47/32-mm HE, M35 (p 75, Fig 92); 47/32-mm AP, M35 (With Cap) (p 76, Fig 93); 47/32-mm AP, M35 (Without Cap) (p 76, Fig 94); 47/32-mm AP, M39 (p 77, Fig 95); 47/32-mm EP (Hollow Charge) (p 77, Fig 96); 47/32-mm EPS (Hollow Charge) (p 78, Fig 97); 57/43-mm AP (Without Cap) (p 78, Fig 98); 57/43-mm AP (With Cap) (p 79, Fig 99); 65/17-mm HE (p 79, Fig 100); 65/17-mm AP (p 80, Fig 101); 65/17-mm EP (Hollow Charge) (p 80, Fig 102); 65/17-mm EPS (Hollow Charge) (p 81, Fig 103); 70/17-mm HE (p 81, Fig 104); 75-mm HE (p 82, Fig 105); 75/13-mm HE (Light Case) (p 82, Fig 106); 75/13-mm HE, M32 (p 83, Fig 107); 75/27-mm HE, M32 (p 83, Fig 108); 75/32-mm HE (p 84, Fig 109); 75/46-mm HE, M34 (p 84, Fig 110); 75/46-mm HE, M36 (p 85, Fig 111); 75/32-mm ADE-HE (p 85, Fig 112); 75-mm AA (p 86, Fig 113); 75-mm AP (p 86, Fig 114); 75/27-mm AP (p 87, Fig 115); 75/32-mm AP (p 87, Fig 116); 75-mm EP (Hollow Charge) (p 88, Fig 117); 75-mm EPS (Hollow Charge) (p 88, Fig 118); 75/13-mm EP (Hollow Charge) (p 89, Fig 119); 75-mm EPS, M42 (Hollow Charge) (p 89, Fig 120); 75-mm Incendiary (F/C) and (F1/C) (p 90, Fig 121); 76/40-45-mm HE (p 90, Fig 122); 76/40-45-mm HE, M36 (p 91, Fig 123); 77-mm HE (Short) (p 91, Fig 124); 77-mm HE (Long) (p 92, Fig 125); 77-mm AA (p 92, Fig 126); 90/42-53-mm HE (p 93,

Fig 127); 90-mm AA (p 93, Fig 128); 90/53-mm AP (p 94, Fig 129); 100-mm HE (p 94, Fig 130); 100/17-mm HE, M32 (p 95, Fig 131); 100-mm ADE-HE (p 95, Fig 132); 100/17-mm ADE-HE (p 96, Fig 133); 100-mm EP (Hollow Charge) (p 96, Fig 134); 100-mm EPS (Hollow Charge) (p 97, Fig 135); 105/28-mm HE (p 97, Fig 136); 105/28-mm HE, M32 (p 98, Fig 137); 105/28-mm ADE, M32 (p 98, Fig 138); 105-mm AP (p 99, Fig 139); 105/25-mm EP (Hollow Charge) (p 99, Fig 140); 105-mm Hollow Charge, M43 (p 100, Fig 141); 120/21-mm HE (p 100, Fig 142); 120/21-mm HE (Cast Steel) (p 101, Fig 143); 120/25-mm HE (Short) (p 101, Fig 144); 120/25-mm HE (Long) (p 102, Fig 145); 120/25-mm HE (Cast Steel) (p 102, Fig 146); 120/40-mm HE (Cast Steel) (p 103, Fig 147); 120/40-mm HE (Base Fused) (p 103, Fig 148); 120/45-mm HE (p 104, Fig 149); 149/12-mm HE (Short) (p 104, Fig 150); 149/12-mm HE (p 105, Fig 151); 149/12-13-mm HE (Light) (p 105, Fig 152); 149/13-mm HE (p 106, Fig 153); 49/35-mm HE, M32 (p 106, Fig 154); 149/35-mm HE, M32/38 (p 107, Fig 155); 149/12-13-mm HE (Cast Steel) (p 107, Fig 156); 149/13-35-mm HE (One-Piece) (p 108, Fig 157); 149/35-mm HE (British) (p 108, Fig 158); 149/35-mm ADE, M32 (p 109, Fig 159); 149/40-mm ADE-HE, M35 (p 109, Fig 160); 152-mm HE (p 110, Fig 161); 152/13-mm HE (Short) (p 110, Fig 162); 152/13-mm HE (Long) (p 111, Fig 163); 152/37-mm HE (p 111, Fig 164); 152/45-50-mm HE (Base-Fused) (p 112, Fig 165); 152/32-45-mm HE (Base-Fused) (p 112, Fig 166); 152/37-mm AP (p 113, Fig 167); 210-mm HE (p 113, Fig 168); 210-mm HE (Cast Steel) (p 114, Fig 169); 210-mm HE (Bomba) (p 114, Fig 170); 210/22-mm HE, M35 (p 115, Fig 171); 260/9-mm HE (p 115, Fig 172); 260/9-mm HE (Cast Steel) (p 116, Fig 173); 305-mm HE (Short) (p 116, Fig 174); 305-mm HE (Long) (p 117, Fig 175); 305-mm HE (Light-Case Long and Short) (p 117, Fig 176); 305-mm HE (British) (Long and Short) (p 118, Fig 177); 305/17-mm HE (p 118, Fig 178); 305/17-mm HE (Heavy) (p 119, Fig 179); 305/17-mm HE (Cast-Steel) (p 119, Fig 180); 305/17-mm HE (One-Piece) (p 120, Fig 181); 380/15-mm HE (Base-Fused) (p 120, Fig 182); 420-mm HE (Short and Long) (p 121, Fig 183); 240 and 400-mm HE (Bomba) - for use in Mortar (p 122, Fig 184)

Abbreviations: **AA** – Antiaircraft; **ADE-HE** – HE Projectile provided with booster system “Detonatore AD Alto Esplosivo”; **AP** – Armor-Piercing (Perforanti); **API** – Armor-Piercing-Incendiary; **EP** – Hollow Charge with Base Fuze; **EPS** – Hollow Charge incorporating a nose fuze with a long flash tube leading to the center of expl charge; **HE** – High Explosive (Alto esplosivo); **I** – Incendiary (Incendario)

Cartoccio a bossolo. Cartridge Case (for Fixed or Semi-Fixed) Rounds (See Illustration under **CARTOCCIO**)

Cartoccio a sacchetto – Cartridge Bag (for Separate-Loading Rounds) (See Illustration under **CARTOCCIO**)

Cartridge Case. See **CARTOCCIO** and under **Bossolo**

CARTUCCIA. Cartridge (plural *Cartucce*). The following items are listed in Military Dictionary (Addnl Ref A):

Cartuccia a capsula centrale. Center Fire Cartridge

Cartuccia a pallottola perforante. Armor-Piercing Cartridge

Cartuccia a pallottola tracciante. Tracer Cartridge

Cartuccia da caccia. Sporting Cartridge (Ref 31, pp 595 & 619)

Cartuccia di lancia. Propellant Cartridge

Cartuccia “Magnum”. Cartridge “Magnum”. Several varieties are described in Ref 31, pp 594–95

Small-arms Cartridges are listed here under *Armi portatili munizioni*, while Artillery Cartridges, which are actually complete rounds (*colpi completi*) are listed under **CARTOCCI GRANATA**

Cava D
Cava I
Cava extra 2 } Italian explosives listed in Ref 31,
p 317 without giving their compns

Centraliti (Centralites), invented in 1906 in Germany, have been used, accdg to Belgrano (Ref 31, p 218), in Italy as stabilizer for NC–NG proplnts. Description of Centralites is given in Ref 24, Vol 2, pp C126ff. Centralites have also been used in some Italian single-base proplnts,

such as *Polvere per mitragliatrice FIAT mod 35*, described here under Nitrocellulose a solvente volatile and in Ref 31, p 204

CG Polvere. See *Polvere CG*

CHEDDITE. Cheddite (plural *Chedditi*) o *Esplosivi Street*. Cheddites, invented in 1897 by E. Street of England, have been patented since 1898 in many countries. Accdg to Dr Omero Vettori of Aulla (Massa Carrara), a subsidiary of the French firm located in Chedde, Haute Savoie, established in 1901 at Salviano, near Livorno, Italy, a plant which is likely to be one of those belonging to the Società Italiana Esplosivo Cheddite with the main office at Torino. This Company, which is now a subsidiary of the S.A. Suisse d’Explosifs, Liestal, near Basel, Switzerland, has also plants located at Torano (Carrara), Borgofranco (Ivrèa) and Cinzano Torinese. Cheddites are expl compns based on chlorates or perchlorates of Amm, K or Na. Other ingredients are combustibles and binder. A detailed description of Cheddites is given in Ref 24, Vol 2, pp C155 to C164

Accdg to Dr Omero Vettori (private communications of 1962 & 1963), the plant of Società Italiana Esplosivo Cheddite at Salviano manufd at that time: Cheddite OS Extra, Cheddite O Extra, Cheddite O Extra B, Plastigel I and Plastigel II. Their compns and props are given in Table 4, p C159 of Ref 24, Vol 2. There is also listed Cheddite gelatina

In the book of Belgrano (Ref 31, pp 355–60) are described chlorate and perchlorate Cheddites

Accdg to Ref 28, p 321, Cheddites are too sensitive to mechanical action to be used as bursting charges in shells, but they can be used for loading land mines (See also Cremonite, Esplosivo 86/14, Esplosivo P, Esplosivo S, Manlianite, Polvere cannel and Romite)

Ciclonite o **Ciclotrimetilentrinitroammia.** See **T₄** and in Belgrano (Ref 31, pp 255–59)

Ciclotetrametilentrinitroammia. Same as **Octogene** o **HMX**. It is described in Belgrano (Ref 31, pp 259–60)

Ciclotol. See **Tritolite**

Cloramite. A mining expl manufd after WWI by the Dinamificio di Orbetello, Italy, utilizing scrap military propellants, consisted of Balistite (or Cordite) 64, Amm Perchlorate 20, Na nitrate 15 & K dichromate 1% (Ref 14, Vol 3, p C329-R & Ref 28, p 321)

Colpo completo (Shot or Complete Round of Artillery Ammunition). Accdg to "MUNIZIONAMENTO ITALIANO" (AddnlRef C), the *colpo completo* consists of: *il proietto* (Projectile); *la carica di lancio* (Propelling Charge); *il cannelo* [Projectile (or Fuze) Primer] and *la spoletta* (Fuze)

In our opinion, to these must be added *il bossolo* (Igniter for Propelling Charge)

Commercial (or Industrial) Explosives of Non-permissible Type are listed in Ref 24, Vol 3, pp C438-R to C440-R. Some of them are also listed here in alphabetical order

Commercial (or Industrial) Explosives of Permissible Type are listed in Ref 24, Vol 3, pp C451-L & C454-L. Some of them are also listed here in alphabetical order

Complete Round of Ammunition. See Colpo completo

Composizioni (o Miscela) fumogene (Smoke Compositions). See under PIROTECNIA o ARTIFICI DA GUERRA and in Belgrano (Ref 31, p 630)

Composizioni illuminanti (Illuminating Compositions). See under PIROTECNIA o ARTIFICI DA GUERRA and in Belgrano (Ref 31, pp 629-30)

Composizioni (o Miscela) incendiarie (Incendiary Mixtures). Not found in the books of Molina (Ref 1), Piantanida (Ref 4), Caprio (Ref 11), Belgrano (Ref 13), Giorgio (Ref 26) and Belgrano (Ref 31), but found in the book of Giua (Ref 19, pp 412-14)

Giua, after giving a general description of incendiaries (including Napalm) used during WWII in aerial bombs, lists on p 414 the following incendiaries patented in Italy after WWII: a) *Termite*, ItalP 448101 (1949) of Ministero della Difesa Aeronautica and in CA 45, 1770

(1951) (Also Ref 31, p 640) consisted of Al 17, celluloid 20, susquiossido di ferro (Fe_2O_3) 43, Ba peroxide (BaO_2) 11.5, Na silicate (Na_2SiO_3) 6.5 and a substance which regulates the duration of combustion (such as bitumen, resin or tar) 2%. The mixture could be heated to 100° and compressed to 5000-6000 atm, w/o danger of expln

b) *Miscela incendiaria Tonegutti*, ItalP 446010 (1949) of Ministero della Difesa Marina e M. Tonegutti and CA 45, 1770 (1951), consisted of K chlorate 50, AN 20, Cu sulfate 10 & Mg (or Al) powder 20%

Another Italian Patent listed in CA is:

c) Bombrini Parodi-Delfino, ItalP 430931 (1948) & CA 43, 8682 (1949): TNT (PETN or RDX) 15-60, oxidizers (such as chlorates, nitrates, oxides, perchlorates or peroxides) 20-40 & finely pulverized metals (such as Al, Mg, Zn or Fe) 20-40%

Composizioni (o Miscela) innescenti (Initiating Compositions) or **Composizioni primari** (Primary Compositions). The following formulations were found in some Italian ammunition captured during WWII and examined at Picatinny Arsenal: a) KClO_3 43, Sb_2S_3 24, MF (Mercuric Fulminate) 24 & abrasive 9%; used in some cartridge cases, such as the 47-mm APRN (Armor-piercing Round Nose) shell b) KClO_3 44, Sb_2S_3 48, MF 6 & abrasive 2%; used as a primer in fuzes of some bombs and in 47-mm APRN shell c) LA (Lead Azide) 55, LSt (Lead Styphnate) 44 & binder 1%; used as the upper charge in detonators with base charge of T_4 (RDX) in some shells (Ref 28, p 322)

The following typical Italian military initiating compns are listed in Belgrano (Ref 31): a) MF 15-40, KClO_3 20-50, gelatine 0.5-2, Sb_2S_3 30-35 & Si carbide 10-20% (p 423) b) MF 13.7, KClO_3 41.5, gelatine 0.7, Sb_2S_3 33.4 & powdered glass 10.7% (p 423) c) MF 38, PETN 15, Sb_2S_3 39, KClO_3 7 & $\text{K}_2\text{Cr}_2\text{O}_7$ 1% (p 425) d) MF 38, PETN 15, Sb_2S_3 40, $\text{K}_2\text{Cr}_2\text{O}_7$ 2 & $\text{Ba}(\text{NO}_3)_2$ 5%. Gave the best results (p 425) e) *Miscela innescenti inossidabili a base di stifenato di piombo e tetrazene* - LSt 25-55, Tetracene 1.2-5, $\text{Ba}(\text{NO}_3)_2$ 25-45, PbO_2 5-10, Sb_2S_3 0-10, CaSi_2 3-15 & glass powdered 0-5% (p 484)

- f) Miscele innescenti inossidabili, found in capsule tipo "Sinoxid" Italiane - LSt 35-40, Tetracene 1-3, $\text{Ba}(\text{NO}_3)_2$ 35-40, Sb_2S_3 10-15, CaSi_2 3-5 & PbO_2 3-4%. Some mixts contd ca 2% of carborundum (p 484)
- g) Miscele inossidabili. Eight formulations contg Ba nitrate, LSt, Tetracene & Sb sulfide are listed on p 485
- h) Miscele inossidabili, such as 1) LA 5, $\text{Pb}(\text{SCN})_2$ 25, KClO_3 55 & Sb_2S_3 15%
2) LA 25, KClO_3 35, Sb_2S_3 35 & SiC 5%
3) LSt 35, Sb_2S_3 5, $\text{Ba}(\text{NO}_3)_2$ 40 & CaSi_2 20% (Ref 31, p 487)
- i) Miscele di innesco non corrosive contenenti fosforo rosso (Noncorrosive Mixtures Containing Red Phosphorus) developed betw 1950 & 1960 at the Olin Mathieson Chemical Corp and probably tried in Italy. We are listing two examples - Red P 25, PETN 5 & $\text{Ba}(\text{NO}_3)_2$ 70% 2) Red P 17, LSt 25, PETN 5 & $\text{Ba}(\text{NO}_3)_2$ 53% (Ref 31, p 488)
- j) Mixtures contg chlorate or perchlorate of thallium developed in 1958-59 by the Manufacture générale des munitions, France, were probably tried in Italy. Three formulations are listed in Ref 31, p 489
- k) Noncorrosive mixts contg nitrate of thallium or/and cesium, developed in 1959 by the Manufacture générale des munitions. Two formulations are listed in Ref 31, p 489
- l) Noncorrosive mixts contg LSt, Tetracene with added 0.1 to 5% "Aerogel", developed in 1957 by the Olin Mathieson Chemical Corp and probably tried in Italy. Several formulations are listed in Ref 31, p 490
- m) Mixtures contg thiocyanate of lead or mercury developed in France and probably tried in Italy. Five formulations are listed in Ref 31, p 491
- Giorgio (Ref 26, p 163) lists several mixtures, among them Cu (Pb or Hg) thiocyanate 30-40, K chlorate 50-55, Sb sulfide 0-10 & powdered glass 0-5%

Composizioni (o Miscele) a luci colorate (Colored Lights Compositions). See under PIROTECNIA o ARTIFICI DA GUERRA and in Belgrano (Ref 31, p 627)

Composizioni di scoppio (Bursting Charge Compositions). See Esplosivi di scoppio

Composizioni (o Miscele) per traccianti (Tracer Compositions). See under PIROTECNIA o ARTIFICI DA GUERRA

Cordite Italiana. See C_2 (Polvere)

Cotone collodio. (Collodion Cotton, abbrd as CC). See under Nitrocellulose

Cotone fulminante. (Guncotton, abbrd as GC). See Fulmicotone under Nitrocellulose

Cremonite. A Cheddite-type expl mixture proposed in 1902 by U. Alvisi - Amm Perchlorate 48.85 & Amm Picrate 51.15% (Molina, Ref 1, p 200)

Cresilite. Mixture of TN-m-Cr (Trinitrometa-cresole) 60 & PA (Picric Acid) 40%, used in Italy for loading large-caliber shells. It was developed in France under the name of *Crésyllite No 2* (Ref 28, p 323 & Ref 31, p 292) (See also Ecrasite)

Demolition Charges. Accdg to OrdnSergeant (Ref 4a, p 18), Italian military demolition expls of WWII were plastic, such as the one consisting of RDX 67.2, NG 16.3, Al 12.2 & wax 4.1% (adds to 99.8%). It was of gray color and the charge shaped like a pancake, ball or hollow cylinder. Another charge consisted of RDX, NG & wax and was of yellow color. The 3rd chge was light-brown in color and consisted of RDX with a desensitizing agent. Mg shavings (1-3 oz per 1 lb of HE) were added to all above demolition chges to increase their incendiary effect

Demolition Fuse, Instantaneous is described under Fuse (Miccia)

Detonatori. See under INNECAMENTO

DINAMITI (Dynamites)

Accdg to Giua (Ref 19, pp 338-45), Italian Dynamites may be subdivided into: I, *Dinamiti a base inerti* (Dynamites with inert base) and II, *Dinamiti a base attiva* (Dynamites with Active Base)

I. *Dinamiti a base inerti* may be subdivided into:

- a) *Tipo I* – Nitroglicerina (NG) 70–75 & kieselguhr 30–25%
- b) *Tipo II* – NG 50 & kieselguhr 50%
- c) *Dinamite nera* (Black Dynamite) – NG 45–55 & coke 55–45%
- d) *Dinamite al carbonie di legno* (Charcoal Dynamite) – NG 90 & charcoal 10%
- e) *Dinamite rossa* (Red Dynamite) – NG 68 & tripoli 32%
- f) *Wetter-dinamite* (Permissible Dynamite) – NG 35–40, kieselguhr 14–10 & Mg sulfate 32–50%
- II. *Dinamiti a base attiva* may be subdivided into:
- g) *Gelatina gomma o Gelatina esplodente* (Blasting Gelatin) – NG 92–93 & CC (Collodion Cotton) 8–7%
- h) *Gelatina esplosiva da guerra* (Military Blasting Gelatin) – NG 86.4, CC 9.6 & camphor 4.0% (Suitable for use as bursting charge)
- i) *Gelatina dinamite* (Gelatin Dynamite or Gelatin) – NG 67–86, CC 3–5.5, KN (Potassium Nitrate) 5–25 & woodflour 2–10%
- j) *Ammon dinamite* (Gelatina 65%) – NG 63, CC 2, AN 30 & woodflour 5%
- k) *Gelatina dinamite incongelabile o antigelo* (Nonfreezing Gelatin Dynamite) – NG 20–55, CC 1–2, Nitrotoluenes 8–21, SN (Sodium Nitrate) with AN 25–60 & cereal flour 1–8%
- l) *Gelatina 40%* – NG 40, drip oil [liq DNT (Dinitrotoluene)] 10, SN 44 & cereal flour 6%
- m) *Ammon-gelatina I* – NG (gelatinized with CC) 40, AN 45, SN 5 & woodflour 10%
- n) *Ammon-gelatina II* – NG (gelatinized with CC) 20, AN 75 & woodflour 5%
- o) *Gelatina Vender o Dinamite incongelabile, Vender* (Gelatin of Vender or Nonfreezing Dynamite of Vender). A series of expls invented by Venzio Vender and manufd before WWII at the Dinamitificio di Cengio. They were based on NG mixed with 10–30% of Dinitromonoformin or Dinitromonoacetin and other usual ingredients of Dynamites. It was claimed that these expls remained plastic at temps as low as -20°C
- p) *Dinamite No 1, Non-gelatinizzate* – NG 70–74 & woodflour 30–26%
- q) *Dinamite No 2, Non-gelatinizzate* – NG 35–48, SN and/or PN 52–39 & cereal flour 12–17%
- r) *Unknown Name Dynamite* – NG 20–25,

AN 20–25, SN and/or KN 30–35 & charcoal 20%

Some Dynamites were used by Italians during WWII as demolition charges

Dynamites and other expls permitted for use in gaseous and/or dusty coal mines are “Esplosivi antigrisoutosi”, “Esplosivi ammissibili” or “Esplosivi di sicurezza” (Ref 28, p 324)

Belgrano (Ref 31, p 170– lists on Table 26 the following Dynamites as the principal expls used in Italy: **GDI, GDII, GD2, GDM, GEO, Gomma A and Gomma B**. All of them are listed, including their properties, under **ESPLOSIVI DA MINA** in Table I. In addition to these, Dynamite **GEOM** is listed there
AddnlRef: L. Avogadro (of Montecatini, Avigliana, Torino), *AnnChim(Roma)* **49**, 352–57 (1959) & *CA* **53**, 15567 (1959) (Sensitization of Dynamite Gelatin by 1–5% of inert substances of high or moderate hardness such as pumice, quartz, Al_2O_3 , hematite, pyrite, etc can raise deton velocity to as high as 6800 m/sec)

Dinamon. Accdg to Belgrano, 1st Edn (1952) (Ref 13, p 163), Dinamon consisted of AN 69, KClO_4 8, TNT 20 & Al 3%. It was listed in Ref 24, Vol 3, p C440-L

Dinamon 1B. Accdg to Belgrano, 2nd Edn (1974) (Ref 31, p 171), it is a mining expl contg NG 3–6%, the rest being AN, TNT, woodmeal and some other ingredients

Echos or Escho. Accdg to Molina (Ref 1, p 342), Esplosivo Echos – AN 75, Si (95% pure) 16, Al pdr 2 & dried horse dung (called “Ipposino”) 7% – was used by the Italians for military purposes. Silicon can be replaced by ferrosilicon. Belgrano (Ref 31) lists it as Echo on p 316 but erroneously gives AN content as 25 instead of 75%

Ecrasite. This name is derived from *Ekrasit*, an Austrian military expl developed in 1892 and used until 1908 when all of its available supply was blown up in Kiev, Russia. Its compn was kept secret and originally was supposed to be Ammonium Trinitrocresylate. Discussion on this subject is given in Ref 24, Vol 5, pp E8-R & E9-L

Ecrasite 60/40. Same as Cresilite or Cresylite No 2

Esanitrodifenilammina, Exil o p-Dipicrilamina. Hexanitrodiphenylamine, $(O_2N)_3C_6H_2.NH.C_6H_2(NO_2)_3$, described, under Diphenylamine, in Ref 24, Vol 5, pp D1434-Rff. Accdg to Ref 28, p 325 it was used as a HE either alone or in mixts with TNT (See also Ref 1, p 399)

Belgrano (Ref 31, pp 375-77) describes it as **Exil** and states that its mixture with TNT & Al has been used in underwater arms (armi subacquee)

Esanitrosorbite (Hexanitrosorbitol). An expl compd first prepd and examined during WWII in Italy by A. Tetramanzi & N. Arnaldi and reported in Atti della Accademia delle Scienze di Torino, Classe di Scienza Fisiche, Matematiche e Naturali 77, 278-81 (1942) & CA 38, 3841 (1944). This compd, $O_2N.O.CH_2[CH(ONO_2)]_4.CH_2.O.NO_2$, was obtd by nitrating sorbitol of high purity by means of fuming nitric acid below 0° , followed by gradual addn of sulfuric acid at below minus 15° . The product obtd, in 97% yield, was (after crystn from alcohol) in the form of platelets of density 1.58, melting at 55° . Its props are reported as follows: Heat of combustion 1465kcal/kg; Heat of formation 135kcal/mole; Heat of explosion 1500kcal/kg; Detonation Velocity 7230m/sec and Sensitiveness to Impact and Stability - similar to NG. It was not considered a satisfactory replacement for NG as a gelatinizer for NC because of physical changes which occurred in the mixture. Its use for military purposes was not reported (Ref 28, p 325)

Escho. See Echos

Esplosivi alla nitroglicerina. See under DINAMITI

Esplosivi Alvisi. Perchlorate-based, Cheddite type, expls patented by Ugo Alvisi beginning in 1899. They were superior to chlorates-based expls. The following are described by Molina (Ref 1, pp 199-200): *Manlianite, Polvere Cannel, Cremonite and Kratite*

Esplosivi ammissibile. Permissible Explosives. See **Esplosivi antigrisutosi**

Esplosivi alti (High Explosives) o Esplosivi dirompenti (Brisant Explosives). To these belong *Esplosivi da guerra*, such as Tritolo (TNT), Pentrite (PETN), T_4 (RDX), Melinite (PA), Tetrile (Tetryl), etc and *Esplosivi da mina*, such as listed in Tables I & III and under DINAMITI, Items a, b, c, d, e, g, h, i, j, k, l, m, p & q. Also Gelignite, Gomma A, Gomma B, etc

Esplosivi antigrandini (Antihail Explosives). See **Antigrandini: Esplosivi, Cannone e Razzi**

Esplosivi antigrisutosi o Esplosivi ammissibili (Antifiredamp Explosives or Permissible Explosives). See under **Esplosivi da mina**, Tables II & IV and under **DINAMITI**, Item f. Also Grisounite and Grisoutina

Esplosivi bassi (Low Explosives). To these belong weak **Esplosivi da mina** (such as **Esplosivi antigrisutosi**), **DINAMITI** with low NG content and **Esplosivi di lancio o Esplosivi propellenti**

Esplosivi deflagranti. See **Esplosivi di lancio**

ESPLOSIVI DA GUERRA o ESPLOSIVI MILITARI. To these belong: *Esplosivi innescenti o primari* (Initiating or Priming Explosives); *Esplosivi di lancio o Propellenti* (Propellants); *Esplosivi di rinforzo* (Booster Explosives) and *Esplosivi di scoppio* (Bursting Explosives). They are described separately below

Esplosivi innescenti o primari. (Initiating or Primary Explosives).

Under this title Belgrano (Ref 31, pp 405ff) describes:

a) *Innescenti primari* (Priming Explosives), which include **Fulminato di mercurio (MF)** (pp 406-428); **Fulminato organico, CHO.CNOH** (p 428); **Fulminato di argento (AgF)** (pp 428-429); **Azotidrati (Azides)**, which includes **Acido azotidrico, HN_3 (Hydrazoic Acid)** (p 429); **Azotidrato di sodio, NaN_3 (SA)** (pp 430-38); **Azotidrato di piombo, PbN_6 (LA)** (pp 438-49); **Azotidrato d'argento, AgN_3** (pp 449-51); **Azotidrato di ammonio, NH_4N_3** (p 451);

Acido stiftico or Trinitroresorcina, $(HO)_2C_6H(NO_2)_3$ (pp 453–55); Dinitroresorcina, $(HO)_2C_6H_2(NO_2)_2$ (p 456); Stifnato di piombo (Lead Styphnate) (LSt) (pp 456–63); Guanilnitrosoammina o Tetrazene (Tetracene), $C_2H_8N_{10}O$ (p 464–67); Solfocianato di piombo (Lead Thiocyanate), $Pb(CNS)_2$ (pp 467–68); Diazodinitrofenolo o DDNP, $C_6H_2N_4O_5$ (pp 471–74); Trinitrofloroglucinato di piombo, $Pb(C_6HN_3O_9Pb)$ (p 475–76); Nitrato di diazobenzene, $C_6H_5.N_2.ONO_2$ (pp 476–77); Solfuro di azoto, N_4S_4 (pp 477–78); Esametilen-triperossidiammina o HMDT, $C_6H_{12}N_2O_6$ (pp 478–79); Cianurazide, $C_3N_3(N_3)_3$ (pp 481–82); Acido diazotriazolcarbonico,

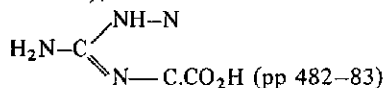

Principal Italian Initiating Compositions (or Mixtures) are described under Composizioni (o Miscela) innescenti

Explosivi da lancio, Explosivi deflagranti o Propellenti (Propellants).

To these belong the following items described in Belgrano (Ref 31): Polvere nera da guerra (p 342), Balistite (p 205), under Polveri senza

fumo (pp 201ff), C_2 (Polvere) (p 210), and Propellenti per razzi (p 128). They are described here separately. To these must be added Filite (qv), which was not described in Belgrano (See also POLVERI ITALIANI DA LANCIO SENZA FUMO)

ESPLOSIVI (o POLVERI) DA MINA. Mining Explosives

Many Italian Mining Explosives are listed under COMMERCIAL OR INDUSTRIAL EXPLOSIVES in Ref 24, Vol 3, on pp C438-R to C440-R (*Nonpermissible Explosives*) and on pp C451-L & R and C454-L (*Permissible Explosives*). Some of them are listed in this section

Belgrano (1952) (Ref 13) lists in Tables on pp 280ff 164 formulations, while in the new edn of Belgrano (1974) (Ref 31) there are listed in Tables 53 to 62 incl, 259 Mining Explosives, some of them French. The tables give, besides comps, the following properties: Trauzl (Lead Block Expansion), Distanza colpo (Gap), and Velocità detonazione (Detonation Velocity) values

The tables which follow list expls selected from Belgrano's books

TABLE I
ESPLOSIVI DA MINA GELATINOSI CON NITROGLICERINA
(Mining Explosives with Nitroglycerol)

Composition (%) and Some Properties	1	2	3	4	5	6	7	8	9	Gomma		
	GDII	GD2		GDI	GDIM	GEOM			GEO	B	A	GDM
Nitroglycerin	43.2	48.3	7.0	60.0	38.0	57.0	71.0	40.75	77.5	82.5	92	38.0
Collod Cotton	2.3	2.7	0.8	3.5	2.3	3.5	5.0	1.5	5.0	5.5	8	2.3
Am Nitrate	—	—	—	—	50.9	29.0	—	17.0	—	—	—	50.4
Am Perchlorate	—	—	44.0	—	—	—	—	—	—	—	—	—
Woodflour	7.0	5.8	1.0	5.2	—	3.5	5.0	—	5.0	3.0	—	—
Dinitrotoluene	—	—	10.0	—	—	—	—	—	—	—	—	—
Trinitrotoluene	—	—	5.0	—	—	—	—	—	—	—	—	—
Na Nitrate	45.5	42.7	32.2	30.5	6.0	7.0	—	—	12.0	8.5	—	6.0
K Nitrate	—	—	—	—	—	—	18.5	—	—	—	—	—
Ca Silicide	—	—	—	—	—	—	—	—	—	—	—	—
Oil	—	—	—	—	2.0	—	—	—	—	—	—	2.5
PETN	—	—	—	—	—	—	—	40.75	—	—	—	—
Ocher, red (Hematite)	—	—	—	0.3	0.5	—	0.5	—	—	—	—	0.5
Ocher, yellow (Limonite)	1.0	—	—	—	—	—	—	—	—	—	—	—
Na Carbonate	1.0	0.5	—	0.5	—	—	—	—	0.5	0.5	—	—
Ca Carbonate	—	—	—	—	0.3	—	added	—	—	—	—	0.3
							0.3					
Trauzl Test, cc	340	355	430	440	475	500	505	525	540	560	630	475
Gap Test, cm	14	15	6	20	21	23	26	25	29	30	35	—
Veloc of deton, m/sec	5000	5200	4700	6000	5900	5400	5900	7000	6700	6900	7200	—

TABLE II
ESPLOSIVI DA MINA POLVERULENTI CON NITROGLICERINA
(Pulverulent Mining Explosives with Nitroglycerol)

Composition (%) and Some Properties	1	2	3	4	5	6	7	8	9	10	11	12
Nitroglycerin	14.0	11.0	10.0	4.0	4.0	8.0	12.4	12.76	4.0	12.0	11.7	9.0
Dinitrotoluene	-	-	-	1.5	-	0.5	0.3	-	-	-	-	-
Trinitrotoluene	-	-	-	-	-	-	-	-	10.0	0.3	-	20.0
Collodion Cotton	0.3	-	0.25	1.5	0.1	0.5	0.3	0.24	-	-	0.3	0.3
Woodflour	-	6.0	-	-	-	-	-	-	-	-	-	-
Cereal flour	-	-	-	-	-	5.0	-	-	-	3.0	-	-
Am Picrate	65.7	51.0	89.75	82.0	89.4	81.0	79.0	83.0	76.0	77.7	76.0	70.7
Na Nitrate	-	-	-	-	-	-	-	-	-	-	-	-
K Nitrate	-	-	-	-	-	-	-	-	-	-	-	-
Dinitronaphthalene	-	10.0	-	-	-	-	8.0	4.0	10.0	-	10.0	-
K Perchlorate	-	-	-	-	-	-	-	-	-	-	-	-
Na Chloride	20.0	22.0	-	11.0	-	-	-	-	-	-	-	-
T4 (RDX)	-	-	-	-	6.5	-	-	-	-	-	-	-
Oil	-	-	-	-	-	-	-	-	-	2.0	2.0	-
Ca Silicide	-	-	-	-	-	5.0	-	-	-	5.0	-	-
Trauzl Test, cc	270	265	300	305	320	375	390	390	400	420	430	450
Gap Test, cm	2	5	20	3	12	6	3	4	11	1	1	6
Veloc of deton, m/sec	2120	2300	2038	1710	2500	3200	2715	3200	2348	2960	2350	2912
Uses	C&SM	C&SM	C&SM	CM	G&OM	C&SM	C&SM	C&SM	OM	OM	OM	G&OM

Abbreviations: CM - Coal Mines G&OM - Galleries & Open Mines
C&SM - Coal & Sulfur Mines OM - Open Mines Only

Note: Composition No 3 is called **Grisoutina**

TABLE III
ESPLOSIVI DA MINA POLVERULENTI SENZA NITROGLICERINA
(Pulverulent Mining Explosives Without Nitroglycerol)

Composition (%) and Some Properties	1	2	3	4	5	6	7	8	9	10	11	12	13	14
Am Nitrate	85.5	77.0	40.0	78.0	82.0	80.0	79.5	70.0	84.5	90.0	-	79.0	70.0	63.0
Dinitronaphthalene	-	-	-	-	-	-	-	5.0	10.0	-	-	-	-	-
Dinitrotoluene	-	-	-	-	1.0	-	-	-	-	-	-	-	-	-
Trinitrotoluene	4.5	15.0	-	16.0	14.0	20.0	10.0	10.0	-	8.0	90.0	-	-	-
Am Perchlorate	-	-	25.0	-	-	-	-	-	-	-	-	-	-	-
K Perchlorate	-	-	-	-	-	-	-	-	-	-	-	-	-	-
K Nitrate	-	-	29.0	-	-	-	-	-	-	-	-	-	-	-
Woodflour	10.0	6.5	4.0	-	3.0	-	2.5	-	-	2.0	-	1.0	-	3.0
Oil	-	-	2.0	-	-	-	-	-	-	-	-	-	-	-
Paraffin	-	-	-	-	-	-	-	-	-	-	-	-	-	-
Na Nitrate	-	-	-	4.5	-	-	8.0	15.0	-	-	-	-	-	13.0
K Bichromate	-	-	-	-	-	-	-	-	4.5	-	-	-	-	-
Carbon (pulverized)	-	1.5	-	-	-	-	-	-	1.0	-	-	-	-	-
Charcoal (pulverized)	-	-	-	-	-	-	-	-	-	-	-	-	-	-
PETN or RDX	-	-	-	-	-	-	-	-	-	-	10.0	20.0	30.0	21.0
Ca Carbonate	-	-	-	1.0	-	-	-	-	-	-	-	-	-	-
Ocher (Hematite)	-	-	-	0.5	-	-	-	-	-	-	-	-	-	-
Trauzl Test, cc	330	330	350	400	420	430	450	360	395	375	400	425	450	480
Gap Test, cm	1	2	3	6	6	7	7	2	3	1	4	5	3	6
Veloc of Deton, m/sec	1900	2300	2400	3600	3700	4300	3500	1600	3100	2300	7000	2850	2100	3000

TABLE IV
 ESPLOSIVI DA MINA CON RESIDUATI DI POLVERI DI LANCIO
 (Mining Explosives Containing Surplus Propellants)

Composition (%) and Some Properties	1	2	3	4	5	6	7	8	9	10	11	12
Ballistite	45	12	—	60	10	10	10	—	50	—	—	—
Polvere B	—	—	—	—	—	—	—	—	—	15	—	—
Polvere C	—	—	54	—	—	—	—	50	—	—	54	50
Polvere Dupont	—	—	—	—	—	—	—	—	—	10	20	40
TNT	—	10	—	—	10	—	4	10	10	10	—	10
Am Nitrate	55	64	—	—	70	80	55	—	—	60	—	—
K Nitrate	—	—	—	40	—	—	5	40	40	—	—	—
Na Nitrate	—	9	26	—	—	—	20	—	—	—	26	—
Am Chlorate	—	—	20	—	—	—	—	—	—	—	—	—
K Perchlorate	—	—	—	—	5.5	10	5	—	—	—	—	—
Woodflour	—	—	—	—	4.5	—	1	—	—	—	—	—
Ca Silicide	—	5	—	—	—	—	—	—	—	5	—	—
Trauzl Test, cc	430	425	445	315	320	330	350	350	375	410	435	435
Gap Test, cm	—	1	7	—	4	4	1	1	1	1	3	4
Veloc of Deton, m/sec	—	—	—	—	3300	3200	1350	1500	1320	2500	2328	2900

Note: After WWII considerable amounts of left-over propellants (both of American & Italian origin) were left unused in Italy. Some of these propellants were used to prepare mining explosives. The usual procedure was to grind a propellant to pass a sieve with 16 openings per sq cm (US Std Sieve No 12) and to mix it with an oxidizer and other ingredients ground to pass a sieve with 20 openings per sq cm (US Std Sieve No 14)

Black Powder is still used in mining and its compn: K nitrate 60–72, carbon 14–21 & sulfur 13–18% is listed in Belgrano (Ref 31, p 342) as *Polvere nera da mina*

Addnl Refs from CA:

A) S. Custodero, ItalP 522944 (1955) & CA 53, 3698 (1959) [Synthetic resin-base expls are prepd by incorporation of oxidizers into a liquid polymer which is then solidified by addn of a suitable catalyst. Thus, to 20% of a mixt contg 100 parts "Araldit D" and 9–10ps "951" (an alipahitic polyamine), 80% NaClO₃ was added with slow stirring to obtain a homogeneous paste. After it was shaped into the desired form by means of a press, it hardened on standing for 14 hours]

B) A. Simoncini, ItalP 515805 (1955) & CA 52, 15910 (1958) [Tannin contg expl mixts and flammable powders are prepd in the following examples: 1) Powdered 76 parts KClO₃, mixed with 24 parts powd chestnut wood extract (I) (as a paste), dried and ground; 2) Powd 38 pts KNO₃ mixed with 16ps (I) and another

38ps KNO₃ mixed with 8ps powd S, moistened, dried and ground]

C) T. Seguiti, IndMineraria (Roma) 16 (6), 289–98 (1965) & CA 64, 7960 (1966) (Explosive mixts contg AN and combustible oil for general mining uses is described in detail)

D) T. Seguiti, IndMineraria (Roma) 16 (8), 413–22 (1965) & CA 64, 7960–61 (1966) (Explosive mixts contg AN and combustible oil for underground uses are described in detail)

Explosivi di rinforzo (Booster Explosives).

The following expls have been used: Acido picrico (Ref 31, p 281); T₄ (RDX) (Ref 31, p 263); Pentrite (PETN) (Ref 31, p 176) and Tetrylite o Tetryl (Tetryl) (Ref 31, p 272)

Illustration of an Italian Booster is given in Ref 16, Fig 38 on p 28

Explosivi di scoppio (Bursting Explosives or Fillers).

Following are the principal High Explosives (Explosivi alti) used as fillers of projectiles, by

themselves, or in compns: Amatolo (TNT 60 & AN 40%) (Ref 31, p 246); Ammonal (Ref 31, p 367); ANS o ASN (Ref 31, p 181); Exil (Hexanitrodiphenylamine) (Ref 31, p 275); Octogene o HMX (Ciclotetrametilentetranitroammina) (Ref 31, p 259); Pentrite o Tetranitropentaeritrite (PETN) (Ref 31, pp 176ff); Pentrite paraffina, 90/10 (Ref 31, p 182); Pentoliti (PETN 20-80 & TNT 80-20%) (Ref 31, p 182); T₄, Esogene o Trimetilentrinitroammina (RDX, Cyclonite or Hexogen) (Ref 31, pp 255ff); Tetryl (Tetryl 75 & TNT 25%) (Ref 31, p 246); Trilite, Tritolo o Trinitrotoluene (Ref 31, p 233); Tritolital (TNT 60, RDX 20 & Al 20%) (Ref 31, p 263); Tritolite (RDX 60, TNT 39 & beeswax 1%) (Ref 31, p 246) and Xilite o Trinitrometaxilolo (Ref 31, pp 248-49) (See also the book of E. Brandimarte, "Cariche di Scoppio", Ref 29)

The following Bursting Explosives patented in Italy after WWII are listed in CA:

a) Montecatini Società Generale, ItalP 433633 (1948) & CA 44, 1709 (1950) [Cast expl prep'd by incorporating RDX (or PETN) 75 with Nitroisobutylglycerol Triacetate 25% at 80°]

b) Polverifici Giovanni Stacchini SA, ItalPats 433636 (1948); 445206 (1949); 445601, 445602 & 445603 (1949) and CA 44, 1709 (1950); 45, 1770 & 3160 (1951) [Compns of RDX (or PETN) 5-65, TNT 30-90 with powdered metal (such as Si, B, Mg, Cu, Fe, Al or Zn) 5-30%]

c) Direzione Superiore del Servizio Tecnico di Artiglieria a Roma, ItalP 450103 (1949) & CA 44, 11098 (1950) (RDX 86-92 mixed with castor oil 8-14% and pressed in the form of beads)

d) Bombrini-Parodi-Delfino S.p.A., FrP 1424216 (1966) (Ital) & CA 65, 10420 (1966) [Plastic explosives of high power suitable as bursting chges can be prep'd as follows: Into molds or bomb bodies are introduced a granulated mixt of NC and HE's, followed by the addn of a solvent contg a nitrate ester, a stabilizer, a plasticizer and sometimes an accelerating agent. The compn. of the final expl may be: NC 5-36, nitrate ester 33-40, HE 20-60, plasticizer 1.5-2.5, stabilizer 0.5-0.6 and accelerating agent 0.4-0.5 part. The granulated compn is prep'd by mixing the NC, the HE, a plasticizer (diethylphthalate) and a stabilizer (Centralite)

with a NC solvent (acetone). The paste obt'd is impregnated in the mold with NG and the DETPh in a solvent, centrifuged, and gelled at 50°]

e) E. Ravelli, ItalP 648270 (1962) & CA 65, 5440 (1965) [Explosives of high density suitable for loading projs are obt'd by mixing T₄ (RDX) and/or Pentrite (PETN) with high density nitrates. For example, compressed mixt of PETN 25 with Pb(NO₃)₂ 75% gave a loading d 2.5 to 2.7; mixt of PETN 29 with Ba(NO₃)₂ 71% or PETN 24, Ba(NO₃)₂ 74 & Zn stearate 2% gave d 2.2-2.3

Esposivi "slurry", developed after WWII in US, were not manuf'd, nor used as of 1974 when the book of Belgrano was published (Ref 31, p 320)

Esposivo 60/40. Amatol contg 60% AN & 40% TNT. See under Amatolo

Esposivo 86/14. Cheddite-type expl consisting of Amm Perchlorate 86 & paraffin 14% (Ref 4, p 230)

Esposivo ASN. See ASN o Antisanzionite

Esposivo FNP. See FNP (Esposivo)

Esposivo MABT. See MABT

Esposivo MAT. See MAT (Picratol)

Esposivo MBT. See MBT (Esposivo)

Esposivo MNDT. See Siperite

Esposivo MST. See Nougat

Esposivo "P". Blasting expl consisting of Amm Perchlorate 61, Na nitrate 30, paraffin 8 & vaseline 1% (Ref 4, p 230). A similar expl, called *Esposivo speciale P* consisted of Amm Perchlorate 53, Na Nitrate 35 & paraffin 12% (Ref 28, p 331). It is called in Ref 1, p 202 *Cheddite speciale P*

Esposivo plastico. A plastic expl suitable for military use consists of RDX 85-89, petrolatum 12-10, plastic binder (Tioplasto molle) 0.5-2 & glycerophthalic acid 0.5-1%. Its Al-contg

modification was: RDX 64-75, petrolatum 10-12, Al powder 25-10, plastic binder 0.5-2 & glycerophthalic acid 0.5-1%

Ref: Dynamite Nobel SA, Milano, ItalP 427535 (1947) & 439931 (1948); CA 43, 4768 (1949) & 44, 6130 (1950) (See also "T₄ plastico")

Esplosivo "S". Cheddite-type blasting expl consisting of NaChlorate 90, paraffin 7 & vaseline 3% (Ref 1, p 205 & Ref 28, p 331)

Esplosivo S20. Military expl consisting of AN 79, TNT 20 & woodflour 1%. It was manufd at Società Stacchini. Its props are similar to those of French *Explosif du type N n^oU*, which consisted of AN 78.7 & TNT 21.3%. Their props are listed on p 332 of Ref 28. See also L. Médard & A. LeRoux, MP 34, 201 (1952)

Esplosivo speciale P. See under Esplosivo P

Exil. See Esanitrodifenilammina

Exogene o Trimetilentrinitroammina (RDX)
See T₄

F₂. A single-base smokeless proplnt listed by Belgrano without giving its compn (Ref 31, p 581)

FB (Polvere). See Polvere FB

FC 4 (Polvere). See Polvere FC 4

Filite. Ballistite proplnt consisting of NC 50 & NG 50% with 0.5-1% aniline added as stabilizer. It was manufd in the form of cords. Not used now because it badly corrodes gun barrels (Ref 24, Vol 6, p F24-R). Not listed by Belgrano

FNP (Esplosivo). High Explosive compn consisting of AN 75, PETN 20 & wax 5%. Was used during WWII press-loaded in some projectiles (Ref 28, p 332)

Fulmicotone (Guncotton). See under Nitro-cellulose

Fulminato d'argento. Silver Fulminate, AgCNO, is described by Belgrano (Ref 31, pp 428-29). It was used in small quantities by the Marina Italiana for special detonators (p 429) (See also Ref 24, Vol 6, pp F223-R to F224-R and Ref 28, p 332)

Fulminato di mercurio. Mercuric Fulminate, Hg(CNO)₂, is described in Belgrano (Ref 31, pp 406-27). It was manufd, accdg to Dr Omero Vettori, during WWII by the Nobel Società Generale di Esplosivi e Munizioni at Tiana and by the Società Anonima Bombrini-Parodi-Delfino at Colloferro-Roma. It has been used in admixture with KClO₃ & Sb₂S₃ with or without powdered glass. Some post WWII formulations are listed here under Composizioni innescenti and in Belgrano, p 423. See also Ref 24, Vol 6, pp F217-L to F230-R and Ref 28, p 333

Fuochi artificiali. See under PIROTECNIA o ARTIFIZI DA GUERRA

Fuse (Miccia). Most important fuses are:

Miccia a lenta combustione - Slow Fuse, such as Safety Fuse. The core of Italian fuse consisted of K nitrate 60, beech charcoal 25, hemp charcoal 5 & Fe oxide 10% (Ref 31, p 523). Other formulations are BkPdrs, such as K nitrate 70 or 77, S 12 or 10 & carbon 18 or 13% (Ref 31, p 524)

Miccia detonante - Detonating Cord or Cordeau. These may have cores of compressed PA (Picric Acid) - deton vel 5000m/s; core of TNT - deton vel 4500m/s; fuse of PETN prepd by a special method and MF (Mercuric Fulminate) fuse prepd by a special method (Ref 31, p 528)

In OrdnSergeant (Ref 4a, p 18) is described a WWII *Instantaneous Fuse for Initiation of Demolition Charges* which contd a core of MF 79.4 with wax 20.6%. When initiated by a cap, the fuse functioned at the rate of about 20000ft/s (6100m/s). If initiated by flame it will burn but its use as slow burning fuse was not recommended

GD1, GD11, GD2 and GDIM. Mining Explosives. Their compns and props are listed under Esplosivi da Mina in Table I

Gelatina 40%. See item 1, under DINAMITI

Gelatina 65%. See Ammon dynamite, item j, under DINAMITI

Gelatina 92/8. Same as Gomma A

Gelatina da guerra. Accdg to Piantanida (Ref 4, p 257), it consisted of NG 86, CC (Colloid Cotton) 10 & camphor 4%

Gelatina dinamite. See item i, under DINAMITI

Gelatina dinamite incongelabile. See item k, under DINAMITI

Gelatina esplodente o Gelatina gomma. See item g, under DINAMITI

Gelatina esplosiva da guerra. See item h, under DINAMITI

Gelatina gomma. See Gelatina esplodente, item g, under DINAMITI

Gelatina P₁. Gelatinous expl used during WWII: DNT 17, CC (Collodion Cotton) 0.5, Amm perchlorate 36, Na nitrate 25, TNT 3.3 & PETN 18% (Adds to 99.8%). Trauzl value 460cc & gap 0cm (Belgrano, Ref 31, p 232)

Gelatina P₂. Gelatinous expl used during WWII: DNT 22.5, CC 0.5, Amm perchlorate 36, Na nitrate 25 & TNT 3.75% (adds to 87.75%); Trauzl value 400c & gap 0cm (Ref 31, p 232)

Gelatina P₃. Gelatinous expl used during WWII: DNT 17, CC 0.5, Amm nitrate 42, K perchlorate 16.5, Na nitrate 18 & TNT 6%; Trauzl value 350cc & gap 0cm (Ref 31, p 232)

Gelatina Vender. See item o, under DINAMITI

Gelatinizzanti (Gelatinizers). Belgrano (Ref 31, pp 218-19) lists: Centralites, phthalides, alkyl-phthalates (such as ethyl & butyl), diphenyl-urethane and ethylphenylurethane

Geligniti. Blasting expls originating in England. The formulation given by Molina (Ref 1, p 291) is NG 59, CC 4, K nitrate 29 & woodflour 8%. Another weaker formulation called *Gelignite d'ammonio* contd NG 29.3, CC 0.7 & Amm nitrate 70%. The stronger formulation was used by Italians as a bursting chge in some Land Mines (Ref 28, p 334)

GEO and GEOM. Mining Explosives. Their compns and props are given in Table I, under ESPLOSIVI DA GUERRA

Gomma A and Gomma B. See Table I, under ESPLOSIVI DA GUERRA

Gomme incongelabili. Accdg to Molina (Ref 1, p 303), these gelatinous, nonfreezing expls were manufd after WWI by the Dinamificio di Orbetello. Their compns were: NG 72 to 65, CC 6 to 5, TNT 7 to 8 & Amm nitrate 15 to 22%

GRANATA (Grenade). Although this term is also applied by the Italians to a *shell* (like German Granate), it is preferred to use the term *proietile* for shell or projectile, as it is in Munitzionamento ITALIANO (AddnlRef C). We are applying the term granata to Hand Grenade (*Granata a mano*) and Mortar Grenade (*Granata a mortaio*), but Italians did not use Rifle Grenade (*Granata da fucile*) during WWII (See also CARTOCCI GRANATA and under Hand and Mortar Grenades)

Grisou (Esplosivi). See Antigrisou (Esplosivi)

Grisoudinamite. Permissible expl contg AN 88, NG 10, CC 0.5 & woodflour 1.5% (Ref 31, p 326)

Grisounite contd 95.5% AN & 4.5% TNN (Trinitronaphthalene) (Ref 31, p 326)

Grisounite gomma contd 70% AN, 29.5% NG & 0.5% CC (Ref 31, p 326)

Grisounite roccia or Rock Grisonite: AN 91.5 & TNN 8.5% (Ref 31, p 326)

Grisoutina. See item 3, in Table II, under ESPLOSIVI DA MINA

Grisoutina all' contd 11.76% NG, 0.24% CC & 88.00% AN (Ref 31, p 324)

Grisoutina all: 13.2% NG, 0.52% CC & 86.55% AN (adds to 100.27%) (Ref 31, p 324)

Grisoutiti o Dinamiti senza fiamma (Flameless Dynamites). They are described by Molina (Ref 1, pp 296ff). One example is given by Belgrano on p 326 of Ref 31: NG 44, NC 12 & MgSO₄.7H₂O 44%. The sulfate served as a cooling agent for the gases of expln

Guanammon. An experimental castable expl mixture of AN 85 & dicyandiamide 15% (Ref 4, p 244)

Hand and Mortar Grenade (Granata a mano e Granata da mortaio). Italian HE-A/P (high-expl-antipersonnel) grenades used during WWII were almost totally of the "offensive" type. Although the loading factor was usually low, the grenade bodies were not adapted for maximum fragmentation. The antitank (A/T) hand grenades were adaptations of the A/P grenades with an addnl charge. There was no evidence of the use of shaped charges in A/T grenades. Likewise, chemical grenades were made of adapted A/P grenades. No rifle grenades were used, but instead there was used a small mortar, serving as a grenade projector. The grenades were of the impact type, being provided with an "all-ways" fuze which armed in flight

The following types are described in TM 9-1985-6 (1953) (Ref 16): Breda Hand Grenades M35, M40 & M42 (pp 155-56, Fig 226); Hand Grenade OTO, M35 (pp 155-157, Fig 227); Hand Grenade SRCM, M35 (p 158, Fig 228); PCR Grenade (p 158, Fig 229); "L" Type A/T Hand Grenade (p 160, Fig 230); Breda Mortar Grenade (pp 160-61, Fig 231); Incendiary Bottle Grenade (p 162, Fig 232); Smoke Hand Grenades (p 162, no Fig); Breda Drill Grenade (p 162, Fig 233); and SRCM Practice Grenade (p 163, Fig 234)

Hexocire (Esplosivi). RDX-Beeswax Explosives. The following formulations are listed in Belgrano (Ref 31, p 264): Hexocire 95/5, Hexocire grafitata 98/2/1 and 95/5/0.5

Hexocire-Aluminum. RDX 80, beeswax 5 & Al 15%; deton vel 8350m/sec (Ref 31, p 264)

Hexogene o T₄. RDX or Cyclonite. Deton vel 8520m/sec at d 1.71 (Ref 31, p 264)

Hexogene-Nylon, 95/5. Deton vel 8600m/sec at d 1.73 (Ref 31, p 264)

Hexaliti. RDX/TNT Explosives, such as 30/70, 50/50, 60/40, 70/30, 80/20 & 90/10. Their deton vels are betw 7240 & 8200m/sec at d 1.6 (Ref 31, p 264)

High Explosives (HE's). See Esplosivi alti

Idrazina o Diammide, H₂N.NH₂, Hydrazine. See Belgrano (Ref 31, pp 127-28) and in this Vol of Encycl, p H190-L

Idrazina nitrato, N₂H₄.HNO₃. Hydrazine Nitrate (Ref 31, p 128) and in this Vol of Encycl, p H 196-R

Idroliti. Ammonium nitrate expls contg water, which serves to lower mp of AN. They were manufd by the Società Dinamite Nobel at Avigliana. The example cited by Piantanida (Ref 4, p 246) contd AN 70, Hexogene (T₄) 20, paraffin 3 & water 7%. This expl was insensitive to shock (Ref 28, p 334)

Igniter Composition for Propellants, reported in OrdnSergeant (Ref 4a, p 17), was BkPdr of compn K nitrate 74.4, charcoal 16.5 & S 9.1%. It was initiated by a primer cap contg MF 28.4, KClO₃ 34.4, Sb₂S₃ 35.6 & ground glass 1.6%

Igniters, Military. See Accenditori militari

Imperialite. Blasting expl consisting of AN 85-90 & Al scales 15-10%. Its inventor Imperiali was killed in a violent expln during mixing of ingredients (Ref 28, p 334 & Ref 31, p 316)

Incendiarie (Miscela). See Composizioni (o Miscela) Incendiarie

INNESCAMENTO (Priming or Initiating of Explosion)

Under this title, Belgrano (Ref 31, p 499ff) describes the following items:

- a) Capsule da mina ordinarie o Detonatori normali (Blasting Caps or Ordinary Detonators) (pp 501-505)
- b) Principali prove da eseguirsi sui detonatori (Principal Tests of Performance of Detonators) (pp 505-507)
- c) Detonatori secondari (Compound Detonators) (p 507)
- d) Detonatori o Inneschi elettrici (Electric Detonators or Primers) (pp 508-510)
- e) Esplositori per l'accensione dei detonatori elettrici (Exploders for Igniting Electric Detonators) (pp 511-514)

f) Accenditori elettrici (Electric Igniters) (pp 514-515)

g) Principal Types of Detonators and Their Characteristics are listed in Table 73, pp 516-17. Twelve types are Italian, the rest are W. German, Austrian, USA and French

Giorgio (Ref 26), under the title "Mezzi d'innescio di uso militare" (Initiating Devices for Military Use), describes the following items:

Detonatori comuni (Ordinary Detonators) (pp 192-94); Detonatori elettrici instantanei (Instant Electric Detonators) (pp 195-98); Detonatori elettrici a ritardo ordinario (Electric Detonators with Ordinary Delay) (pp 198-99); Detonatori elettrici a microritardo (Electric Detonators with Micro Delay) (pp 199-200); Miccia a lenta combustione (Slow Fuse) (pp 189-92); Miccia detonante (Detonating Fuse) (pp 200-202); Miccia a rapida combustione (p 202); Cordone di accensione, called in US Igniter Cord and in Italy **Pirofis** (pp 202-203)

Accdg to OrdnSergeant (Ref 4a, p 18), Italian Detonators of WWII contd as a primary charge a mixt of LSt (Lead Styphnate), LA (Lead Azide) and, as a secondary (base) charge, PETN (Pentaerythritol Trinitrate)

Addnl Ref from CA:

E. Brandimarte, RivAeronaut, Astronaut-Missil 47 (1), 75-97 (1971) & CA 74, 119 (1971) [Discussion on types of detonators, including metal filaments, is given. Some detonation parameters for T₄ (RDX), Tritolo (TNT), NG, MeNO₃ and Tritolite (TDX-TNT mixt) are included]

Kratiti e Nitrokratiti. Series of expl mixtures developed by U. Alvisi, which consisted of Ammonium Perchlorate with NG and/or NC (Ref 1, p 200 & Ref 31, p 363)

Land Mines. See under Mines and Traps

Luci colorate (Miscela). See Composizioni (o Miscela) a luci colorate in Belgrano (Ref 31, p 627) and under PIROTECNIA o ARTIFICI DA GUERRA

M4, M6, M8 Polveri al nitrometriolo. See under Polvere al nitrometriolo

MABT. High Explosive compn consisting of PA, TNT & DNPhenol. Can be prepd by mixing MAT with MBT. Used as bursting charge (Ref 11, Vol 2, p 119)

Manlianite. A Cheddite-type expl consisting of Amm Perchlorate 72, carbon 14.7 & sulfur 13.3%. It was proposed by U. Alvisi (Ref 1, p 199)

MAT (Picratol). A castable HE mixture of PA 60 & TNT 40%. It is a yel-buff solid which on heating becomes plastic at 55° and melts at 85°. Its props are: Ballistic Strength 103% TNT; Brisance by Sand Test 44g sand crushed vs 43g for TNT; Explosion Temperature 240-280° in 5sec; Impact Sensitivity with 2kg Weight 13 inches vs 14 inches for TNT; Rifle Bullet Sensitivity, 10% detonations from impact of a .30 cal bullet fired at a distance of 90 feet; Stability, stable in storage; Velocity of Detonation 7100m/sec at density 1.62 vs 6900m/sec for TNT. Used for cast-loading medium caliber shells (Ref 11, Vol 2, p 111 & Ref 28, p 335)

MBT (Esplosivo). A castable HE mixture of PA 60 & DNPhenol 40%. It is a yel solid which becomes plastic at 68° and melts at 77°. It is less brisant and less powerful than TNT and requires a strong initiator for detonation; used for loading medium caliber shells. Its mixture with MAT is known as MABT (Ref 11, Vol 2, p 119 & Ref 28, p 336) [Comp with French DD (Explosif) and Japanese Chaōyaku]

Melinita (Picric Acid), described here as Acido picrico

Metriolo (Nitrometriolo) o Nitropentaglicerina, H₃C.C(CH₂ONO₂)₃, (Metriol Trinitrate, MtrTN). A slightly turbid, heavy explosive oil developed before WWII by the SA Bombrini Parodi-Delfino (BPD) and manufd at the Colloferro-Roma Plant. It was obt'd in 92% yield by nitrating trimethylolmethane in a batch process using mixed nitric-sulfuric acid of zero water. The process is similar to that used for prepn of NG, except that high ratios of acids are used. A detailed description of prepn is

given in PATR 2510 (1958), p Ger 113-L

Metriol Trinitrate has been used in smokeless propellant, such as in *Polvere BPD* described by Caprio (Ref 11, Vol 2, p 154). By itself, MtrTN does not gelatinize NC unless at temps of at least 110°. However, when ca 8% of acetylmetriolo (triacetate of metriol), $H_3C.C(CH_2.OCH_3)_3$, is added, gelatinization takes place at 80°. The cool *Polvere BPD* described by Caprio (Ref 11, Vol 1, p 156) contd: MtrTN 59, NC 33, acetylmetriol 5.5 & Centralite 2.5%

Advantages of MtrTN are low volatility, low calorific value (which means less erosion of gun barrels) and a good degree of flashlessness. The Italian Navy was greatly impressed by the considerably reduced flash in "Metriolo propellenti" (Ref 28, p 336)

Mezze d'innescio (Initiating Devices). See under INNESCAMENTO

Mezze d'innescio di uso militare (Initiating Devices for Military Use). See under INNESCAMENTO

Miccia (Fuse). See under INNESCAMENTO

Mines and Traps. Italian antipersonnel (A/P) land mines of WWII were operated by pressure or trip wires. They were often difficult to detect, especially those operated by pressure in which only a portion of the lid or igniter appeared above the ground. Bakelite and wood were used in the construction of some mines to prevent detection by magnetic instruments

Anti-tank (A/T) mines varied in appearance, being tubular, rectangular, or circular in shape. Some were made of bakelite or wood

Improvised mines seem to have been the Italian specialty in the field. They used the majority of such mines in Abyssinia, since the supply of standard mines was apparently limited. Most of these mines were of wooden construction and used blocks of TNT for the bursting charge. Sometimes shells and shrapnel were used for mines

The following items are described in TM 9-1985-6 (1953) (Ref 16): Picket A/P Mine (p 165, no Fig); B-4 A/P Mine (pp 165-66, Fig 236); Bakelite and Wooden A/P 1-lb Mine (p 166 & p 237); Ratchet Mine (Railroad Mine) (p 167, Fig 238); Railway Mine (pp 167-68,

Fig 239); Wooden Box A/T Mine (p 168, Fig 240); Four-Igniter A/T Mine (pp 168-69, Fig 241); A/T Mine B-2 (pp 169-70, Fig 242); A/T Mines V-3 and V-5 (p 170, Fig 243); Pignione Type I & II Bakelite A/T Mine (pp 171-72, Fig 244)

Note: Although the title of the Section includes the word "Traps", no description of such item is given

Miscela C o PE. A plastic expl consisting of RDX and a plasticizer; *Miscela C₂* - RDX, CC & plasticizer is water-resistant; *Miscela C₃* - RDX, Tetryl, CC & plasticizer; *Miscela C₄* - Plastic expl consisting of RDX 91 with Polyisobutylene & other ingredients (Ref 31, p 263)

Miscuglio nitrico-solfurico per nitrazione. (Mixture of nitric-sulfuric Acids for Nitration). As an example, Belgrano (Ref 31) describes on pp 159-162, prepn and analysis of acids used in nitration of glycerol

MNDT. See Siperit

MST. See Nougat

MTX. A mixture of French origin: Melinite (PA) 55, TNT 35 & Xilite (TN-meta-Xylene) 10% (Ref 31, p 249)

NAC. See *Polvere NAC*

NA-OC (Nitrato ammonico-olio combustibile). See AN-FO

Nitram X. One of the mining expls, listed in Ref 31, p 171

Nitramite o Avigliana 3. An Ammonal-type expl mixture consisting of AN 71-72, Al 22 & bitumen pitch (or paraffin) 6-7%. Used as a bursting charge in all types of ammunition (Ref 4, p 238; Ref 28, p 337 & Ref 31, p 316)

Nitrato ammonico o Nitrato d'ammonio (Ammonium Nitrate, abbrd as AN). It is described in Ref 31, p 306-16. Used in a wide variety of military and commercial expls, such as: Afocite, Albite, Amatolo, Ammonal, Ammonite No 1, ANS or ASN, Astralite, Cremonite, Dinamiti,

Dinamon, Echos or Escho, Esplosivi da guerra, Esplosivi da mina, Esplosivo S20, FNP Esplosivo, Gelignite, Gomma, Idrolita, Imperialite, MST or Nougat, PAN, PANA, PNP, Polvere "Cannel", Romite, Sabulite, Schneiderite, Siperite, Solfite, Umbrite, Vibrite, Virite and others (Ref 28, p 337)

Nitre X Galleria. One of the mining expls listed by Belgrano (Ref 31, p 171) without giving its composition

NITROCELLULOSE o NITROCOTONE. There are three Italian basic types for use in *Polveri senza fumo* (Smokeless Propellants):

A. **Cotone collodio** (Collodion Cotton), which contains 11.2 to 12.3% N

B. **Pirocollodio** (Pyrocotton), which contains 12.5 to 12.7% N

C. **Fulmicotone o Cotone fulminante.** (Guncotton, abbrd as GC), which contains 13.2 to 13.4% N (Ref 31, p 188)

All NC's may be divided into the following groups:

a) *Nitrocellulose a solvente volatile* (NC used with ether-alcohol solvent) is usually Pirocollodio. As an example of its use is the Polvere per mitragliatrice FIAT mod 35 (Propellant for machine gun FIAT, Mod 35), which consists of NC 97, Centralite 2 & DPhA (Diphenylamine) 1% (Ref 31, p 203)

b) *Nitrocellulose a solvente fisso* (NC used with fixed solvent) is usually Cotone collodio of N content ca 12% and Pirocollodio. As a fixed solvent, NG or its mixture with NGc (Nitroglycol) is used. *Polveri NAC* (qv) is an example of using Cotone collodio and *Balistite attenuata* (qv) is an example of using Pirocollodio (Ref 31, pp 205-06). Other examples of proplnts using NC with fixed solvents are *Polveri FB, FC*, al nitrodiglicol, al nitrometriolo, and al trinitroanisolo are listed in Ref 31, pp 208-10 and also here under *Polveri*

c) *Nitrocellulose a solvente misto* (NC used with mixed solvent) is usually a mixture of Pirocollodio & Fulmicotone. Mixtures of NG with ether-alcohol or with acetone are used as solvents. Examples of these propellants are *Polvere C₂* and *Solenite ordinaria* (Ref 31, p 212)

Nitrocrafiti. See under *Kratiti* and in Ref 31, p 363

Nitrodiglicole, Nitroeterolo o Dinitrodietilenglicol (Diethyleneglycol Dinitrate, abbrd as DEGDN), $O_2NO.CH_2.O.CH_2.ONO_2$, is described in Belgrano (Ref 31, pp 136-39).

Colorl expl liq used as a component of proplnt, and composite expls. The Italian Army Specification Requirements listed in the pamphlet "Capitolato Tecnico Generale per la Fornitura di Esplosivi Propellenti", MD Esercito (1951), CTF 28, are as follows: N content 14.10%, alkalinity (as % Na_2CO_3) 0.0023; and stability by 120° German test, 30 mins for red coloration of indicator paper (Ref 28, p 337)

Two composite expls contg DEGDN are listed in Ref 31, pp 139-40: a) *Explosivo da mina* - DEGDN 36.5, CC 1.5, PETN 10.0, AN 28.0 & Na nitrate 24.0% 6) *Explosivo plastico* - DEGDN 32 & RDX 68%, experimentally used by Ital Genio Militare (Corps of Engineers)

Two *Polveri al nitrodiglicol* are listed in Ref 31, p 208: a) A 860cal/g-DEGDN 68, Nitroacetylcellulose 30 & Centralite 2% b) A 730cal/g-DEGDN 27.0, Nitroacetylcellulose 63.5, acetylcellulose 5.0 & Centralite 5%

Nitrogelatina. Same as *Gelatina dinamite*, described as item i, under *DINAMITI*

NITROGLICERINA, Trinitroglicerina o Olio esplosivo (Nitroglycerol, abbrd as NG),

$(O_2NO)H_2C.CH(ONO_2).CH_2(ONO_2)$. An oily expl liquid first prepd by Ascanio Sobrero in Univ of Torino, Italy. A detailed description of its prepn, props., analysis and uses is given by Belgrano (Ref 31, pp 140ff)

The Italian Army Specification Requirements as of 1951 were as follows: Titolo d'azoto (N content) 18.36%; Reazione (Reaction) neutral to phenolphthalein; and Stabilita al saggio Abel a 80°C (Stability by Abel Test at 80°C), 14 minutes (Ref 28, p 338)

Used in many military and commercial expls and proplnts, such as *Balistite* & other double-base proplnts, *Dinamiti*, *Explosivi da mina*, *Gelignite*, *Gomma*, *Pentrite* & others

Nitroglicol o Dinitroglicol [Ethyleneglycol Dinitrate (EGDN) or Nitroglycol (NGc)], $O_2NO.H_2C.CH_2.ONO_2$. An oily expl liquid, first prepd in 1870 by Henry. Its prepn, props and analysis are described by Belgrano (Ref 31, pp 133-36)

Used in many countries as an additive to NG to prevent its freezing. Such expls are known as Dinamiti and Gelatine incongelabili

Nitroguanidina (Nitroguanidine, abbrd as NGu), $H_2N.C(:NH).NH.NO_2$, wh ndls, mp 246-47°, first prepd in 1874 by Jouselin. Its prepn, props, uses and analysis are described by Belgrano (Ref 31, pp 251 to 254). NGu has been used as a component of military and commercial expls and as a cooling agent for smokeless proplnts. Four mining expls contg 15 to 28% are listed in Ref 31, p 253 and in Ref 28, p 338. Expl compns *Albite* and *Umprite* were used during WWII as bursting charges (Ref 28, p 338)

Nitrometriolo (Metriol Trinitrate). See under Metriolo

Nitronaftiti. Accdg to Piantanida (Ref 4, p 236), they are mixts of RDX 75-80 with MN-Naphthalene 25-20% manufd by the SA Dinamite Nobel at Avigliana. The mixt softens at 75-80° but does not melt; is press-loaded, while soft, in ammunition (Ref 28, p 339)

Accdg to Belgrano (Ref 31, p 26), Nitronaftiti are plastic mixts of RDX & DNNaphthalene, fusing at 70-80°. They are more powerful than TNT

Nobelite Galleria. A mining expl consisting of NC 37, $KClO_4$ 34, $NaNO_3$ 24, DNT 3 & mineral oil 2%; temp of expln 2800°C; burns in air at ca 130° (Ref 31, p 362)

Nougat o MST (Esplosivo). An Amatol-type expl consisting of AN 49, TNT 44 & DNNaphthalene 7% (Ref 11, Vol 2, p 93 & Ref 31, p 297). It has been used cast-loaded in the following shells: 120/21mm HE, 120/21mm HE (cast steel); 149/35mm HE, 149/35mm HE (one piece); 210mm HE (bomba), 305/17mm HE (cast steel) and 305/17mm HE (one piece) (Ref 28, p 339)

NTP. A military expl mixture consisting of AN 77, RDX 20 & paraffin 3%; deton vel 5850m/sec at d 1.62 (Ref 11, Vol 2, p 114 & Ref 31, p 266)

NX. Mixture of AN 77 & Xilite (TN-m-xylene) 23% (Ref 31, p 249)

Obice. Howitzer

Olio da combustione. Fuel Oil

Olio esplosivo. One of the names for NG (Nitroglycerol)

Olio di sgocciolamento (Drip Oil in the USA and Tröpföl in Germany). A crude, commercial, black, oily substance resulting from the two-stage nitration of toluene in the manuf of TNT. Its main constituents are isomers of DNT with small quantities of isomers of TNT and some other aromatic nitrocompounds. It has been used as an antifreeze addn to Dynamites, such as in Dinamiti incongelabili; in some AN expls and as a gelatinizer of NC used in some proplnts. Due to the fact that its composition is variable, and it contains some sulfuric acid derivatives, its use in military expls is not recommended

Another way to utilize "drip oil" is to separate it from purified DNT, and nitrate the oil to TNT, thus making the manuf in three stages. The resulting product is nearly as powerful as TNT but of inferior stability (Ref 28, p 339)

A typical commercial explosive is given on p 340 of Ref 28: Olio di sgocciolamento 16, TNT 7, AN 45, Na nitrate 15 K perchlorate 16.5 & CC 0.5%

Ossonite. A liquid, Sprengel-type expl, prepd *in situ* by mixing ca 58 parts of PA (or 28 pts of MNB) with concd nitric acid, just before use (Ref 31, p 379). Accdg to Ref 28, p 340, some liquid N peroxide is also added to PA and nitric acid

Oxiliquite. It is one of the *esplosivi all'aria liquida* (Liquid Air Explosive) prepd *in situ* by pouring liquid air (or liquid oxygen) into a mixture of 3 parts of carbon, impregnated with 2 parts of petroleum (Ref 31, p 305)

Oxilite. A liquid air expl prepd *in situ* by pouring liquid air (or liquid oxygen) into a mixture of fossil flour, previously impregnated with petroleum (Ref 31, p 305)

NOTE: Accdg to Belgrano both mixts (Oxilite & Oxilite) have been used in high mountains for construction of hydroelectric plants, for construction of the Sempione tunnel and for work by Genio Militare (Corps of Engineers) (Ref 31, p 305)

P₁, P₂ & P₃. See Gelatina P₁, P₂ & P₃

PA (American). Abbrn for Picric Acid

PA (Italian). Mixtures of Pentrite (PETN) with Acetato di pentaeritrite (Pentaerythritol Tetranitrate or PETA in proportions of 65/35 & 75/25. They were developed by BPD (Bombrini-Parodi-Delfino SA, Colloferro-Roma). They melt at 85–88°, have the same power as TNT and are fairly insensitive to shock. PA mixts were proposed for cast-loading shells, but were seldom used because PA is more expensive than TNT. Accdg to Piantanida (Ref 4, p 232), PA was also used in compressed form as a secondary chge in detonators. See also Ref 28, p 340 & Ref 31, p 182)

Palla – Solid Shot; Ball

Palla dum dum – Dumdum Bullet

Palle – Ball Ammunition

PALLOTTOLA – Bullet; Rifle Bullet; Shot

Pallottola esplodente – Explosive Bullet; Dumdum Bullet

Pallottola perforante – Armor-piercing Bullet

Pallottola a revestimento d'acciaio – Steel-jacketed Bullet

Pallottola traccianti – Tracer Bullet

PAN. Mixture of PETN 42, PETA 23 & AN 35% developed by BPD for press-loading ammunition (Ref 4, p 232; Ref 28, p 340 & Ref 31, p 182)

PANA. HE mixt of PETN 32, PETA 24, AN 35 and Al powder 9% developed by BPD for press-loading ammunition. It is more powerful than Ammonal, but also more expensive (Ref 4, p 232; Ref 28, p 340 & Ref 31, p 182)

PE (Amer). Abbrn for Pentaerythritol

PE (Italian). Designation of *Miscela C* (qv). Do not confuse with C (Polvere)

Pentaerythritol Tetranitrate (PETN). See PENTRITE

Pentolite. See Pentritolo and Pentrol

Pentriniti. Powerful mixts of PETN 80–85 & NG 20–15% invented in 1929 by the late Dr A. Stettbacher of Switzerland. They are described by E. Piantanida in MAF 14, 458 (1935). Belgrano (Ref 31) gives on p 182 its compn but does not list its props

PENTRITE o Tetranitrato di Pentaeritrite (Pentaerythritol Tetranitrate, abbrd as PETN), $C(CH_2ONO_2)_4$. Its prepn, props, uses and analysis are described by Belgrano (Ref 31, p 176–183)

Its props given on p 181 of Ref 31 are as follows: Density (max) 1.62, Explosion Temperature 195°, Flame Temperature on Explosion (Temperature Developed on Explosion) 3600°, Heat of Explosion 1400kcal/kg, Specific Pressure 10500atm/kg, Volume of Gas at 0° & 760mm 780 l/kg, Trauzl Test 500cc, Impact Sensitivity with 2kg Weight 30cm and Detonation Velocity 8400m/sec. Giua (Ref 19) gave some slightly different values, such as: Explosion Temperature 190°, Flame Temperature 4050°, Trauzl Test 540cc and Impact Sensitivity with 2kg Wt 38cm (listed also on p 258 of Ref 31)

Straight, compressed, PETN was used during WWII as a bursting charge in small caliber shells (such as 20mm) and as a booster or base chge in detonators. PETN, phlegmatized by 8–10% wax (or paraffin) and dyed blue, was used as bursting charge in shells larger than 20mm and as demolition charges (Ref 28, p 341)

PETN was also used in composite expls, such as ASN, Esplosivi da guerra, Esplosivi da mina, FNP Esplosivo, Idrolita, Nitronaftita, PA, PAN, PANA, Pentriniti, Pentritolo, Pentrol, PNP Esplosivo, Unknown Name Explosives and others

Pentritolo o Pentrol (Pentolite). Mixtures of PETN & TNT in various proportions. Accdg to Caprio (Ref 11, Vol 2, p 115), mixts of TNT with PETN 40–60% were used under the name of Pentrol, by the Genio Militare (Corps of Engineers) in demolition charges. Accdg to Ref 28, pp 341–42, mixts of PETN 50–80 and TNT 50–20% were used as early as 1934 as bursting charges in land mines, demolition charges, and in some underwater ammunition, such as depth charges. Some Pentritols were dyed red and some of them further phlegmatized by immersing in molten paraffin or by incorporating some MNT (Mononitrotoluene) in the mixture. Accdg to Belgrano (Ref 31, p 182), mixts with 40–60% PETN, called Pentrol, have been used in granate (shells or grenades), razzi (rockets), proiettili anticarro (A/T projectiles) or for cariche cave (shaped charges)

Pertite. See ACIDO PICRICO

PETN. See Pentrite

Picramide. See Trinitroanilino

Picrato ammonico o Picrato di ammonio (Ammonium Picrate or AP), $(\text{O}_2\text{N})_3\text{C}_6\text{H}_2\cdot\text{ONH}_4$. Its prepn and props are in Belgrano (Ref 31, pp 288–89). Straight AP has been used in the US, under the name *Explosive D*, while in Italy it was used in composite expls *Cremonite* (qv) & *Picratol*

Picratol. Mixture of Ammonium Picrate 52 & TNT 48% listed in Belgrano (Ref 31, p 246) as for use in semi-armor piercing projectiles. Its power by Trauzl test is 380cc vs 285cc for TNT

Piombite. Accdg to Caprio (Ref 11, Vol 2, p 96) and Belgrano (Ref 31, p 351), it is an expl mixture consisting of Lead nitrate 76, Trinitronaphthalene 16, Calcium silicide 5 & vaseline 3%. Trauzl Test value 155cc vs 285cc for TNT. It was used in mining expls

Accdg to Molina (Ref 1, p 358), the following Piombite was used during WWI as a bursting charge in cast-iron shells of medium caliber: Pb nitrate 75, Ca silicide 16, Pb carbonate (basic) 6.5, TNNaphthalene 1.5 & vaseline oil 1% (See also Ref 28, p 342)

Pirocollodio. See under Nitrocellulose

PIROTECNIA o ARTIFIZI DA GUERRA

(Military Pyrotechnics). Colonel and now General Attilio Izzo in "Pirotechnia e Guochi Artificiali" (Pyrotechnics and Fireworks), listed as Ref 12, describes various Italian military pyrotechnic devices and gives on pp 204–238 numerous compositions. More recent book is that of Dr Camillo Belgrano (Ref 31) who on pp 623–35 lists, under the title "Pirotecnia", many compns

A. Composizioni a luce gialla per stelle (Compns for yellow light stars) a) NaNO_3 74, S 8 & Al 18% b) KNO_3 14, NaHCO_3 5, pulverin (meal powder) 23 & shellac 6% (Izzo, p 204)

B. Comp a luce gialla per segnalazioni (Compns for yellow light signals) a) NaNO_3 55.5 & polyvinyl chloride 44.5% b) KNO_3 62.5, NaNO_3 10.5, S 23 & charcoal 4% (Izzo, p 204)

C. Comp a luce gialla per torre (Yel light compn for torches) KClO_4 18, Na oxalate 9, $\text{Ba}(\text{NO}_3)_2$ 60, S 4 & shellac 9% (Izzo, p 205)

D. Comp a luce rossa per stelle (Compns for red light stars) a) KClO_3 40, $\text{Sr}(\text{NO}_3)_2$ 40, charcoal 6, lampblack 6 & tar 8% b) KClO_3 60, $\text{Sr}(\text{NO}_3)_2$ 25 & shellac 15% (Izzo, p 207)

E. Comp a luce rossa per segnalazioni (Compns for red light signals) a) KClO_3 30, $\text{Sr}(\text{NO}_3)_2$ 44, S 18, charcoal 2 & Sb_2S_3 6% b) KClO_4 54, $\text{Sr}(\text{NO}_3)_2$ 36 & shellac 10% (Izzo, p 207)

F. Composizioni per traccianti (Tracer Compns). In the book of Izzo (Ref 12, pp 210, 213 & 235) are listed a) Red (rosso) -colored tracer – SrO_2 40, Mg (powder) 40 & Sr oxalate 20% b) Green (verde) tracer – BaO_2 72.5, Mg 15; Ba oxalate 5 & gumlac 7.5% c) Yellow (giallo) tracer – KNO_3 50, red arsenic 30 & sulfur 20%

In the book of Belgrano (Ref 31, p 633) are listed under the title traccianti a) Red tracer – Sr nitrate 69, Mg 25 & binder 6%; b) Green tracer – Ba nitrate 55, Mg 35 & binder 10%; c) Tracer – KClO_3 58, SrCO_3 22 & shellac 20%

A typical Italian tracer compn examined during WWII at Picatinny Arsenal contd Ba nitrate 63.0, Mg pdr 34.3 & binder-fuel 2.7%. It was used in 47-mm AP (Armor-piercing) Shell (Ref 28, p 322)

G. Comp a luce verde per stelle (Compns for green light stars) a) KClO_3 30, $\text{Ba}(\text{NO}_3)_2$ 53, shellac 15 & lampblack 2%; b) $\text{Ba}(\text{NO}_3)_2$ 70, shellac 17 & milk sugar 13% (Izzo, p 211)

H. Comp a luce verde per segnalazioni (Compn

for green light signals) KClO_3 31, $\text{Ba}(\text{NO}_3)_2$ 52, S 10 & charcoal 6% (Izzo, p 211)

I. *Comp a luce verde per traccianti* (Green light tracer compn) BaO_2 72.5, Ba oxalate 5, Mg 15 & gumlac 7.5% (Izzo, p 213)

J. *Comp a luce azzurra per stelle* (Compn for blue light star) a) KClO_3 70, ammoniacal Cu sulfate 15 & shellac 15%; b) KClO_3 50, Paris green 20, $\text{Ba}(\text{NO}_3)_2$ 17, shellac 10 & gum arabic or dextrin 3% (Izzo, p 213)

K. *Comp a luce azzurra per segnalazioni* (Compns for blue light signals) a) KClO_3 54.5, ammoniacal Cu sulfate 27.5 & charcoal 18%; b) KClO_3 53, ammoniacal Cu nitrate 26, S 5 & charcoal 16% (Izzo, p 214)

L. *Comp a luce violetta per stelle* (Compn for violet light star) KClO_3 58.5, $\text{Sr}(\text{ClO}_3)_2$ 14.5, CuCO_3 10, gumlac 7 & S 10% (Izzo, p 215)

M. *Comp a luce bianche per stelle* (Compns for white light star) a) KNO_3 65, S 19 & Sb_2S_3 16%; b) KNO_3 59, S 30 & pulverin (meal powder) 11%; c) KNO_3 60, charcoal 8, pulverin 8, iron filings (paraffined) 16 & gum arabic or dextrin 8% (p 216) and d) KClO_4 61, Al 31 & lycopodium powder 8% (p 218)

M₁. *Comp per stelle* (Star compns). Belgrano, pp 632–33 lists the following compns: a) NaNO_3 74, S 8 & Al 18%; b) NaNO_3 56, S 21, charcoal 14, Na bicarbonate 4.5 & SrSO_4 4.5% and c) Ba nitrate 50, KClO_3 35 & gumlac 15%

N. *Comp a luce bianche per segnalazioni* (Compn for white light signals) a) KNO_3 52, S 22, pulverin 22 & Sb_2S_3 4%; b) KNO_3 61, S 19, pulverin 5 & Sb_2S_3 15% (Izzo, p 218)

O. *Comp per miscela sibilanti* (Compns for whistling mixtures) a) K picrate 70 & NaNO_3 30%; b) Gallic acid 50 & KClO_3 50% (Izzo, p 226)

P. *Composizione per fumata grigia* (Compn for gray smoke) KNO_3 50, lampblack 12.5, charcoal 12.5, colophony 12.5 & As_2S_2 12.5%. The mixt is packed in cylinders 10cm in diam and 25cm long. For its initiation, a mixture of KNO_3 66, S 13, pulverin 11 & Sb_2S_3 11% is used (Izzo, p 231)

Q. *Composizioni per miscela fumogene a fumo bianco* (Compn for mixt producing white smoke). Formula used by Italians during WWI: NaNO_3 25, mineral oil 15, sawdust 50 & water 10%. It was initiated by a mixture of NaNO_3 47.5, KNO_3 5 & sawdust 47.5% (Izzo, p 233). Belgrano, p 631 gave CCl_4 50, Zn dust 25, ZnO 20 &

fossil meal 5%

R. *Miscela all'esacloroetano* (Mixtures with hexachloroethane). There are two mixts proposed by Izzo and three mixts by the Società ACNA. They contd 45 to 52.5 hexachloroethane, 25 to 31.5 Zn dust, 0 to 2.0% ZnO and some other ingredients (Izzo, p 234). Belgrano, p 631, gives HClEt 50, Zn 25, ZnO 20 & fossil meal 5%

S. *Composizione a tetracloroetano* (Compn with tetrachloroethane): TeClEt 40, ZnO 20, Zn dust 15, Ca silicide 15 & NaClO_3 10% (Izzo, p 234)

T. *Composizioni per miscela fumogene colorate* (Compns for colored smoke mixts). Good results were claimed to be obt'd with the following: Coloring substance (dye) 36, KClO_3 28, milk sugar 28, sulfur 4 & Amm chloride 4% (Izzo, p 231)

U. *Composizioni a fumo giallo* (Compns for yellow colored smoke) a) KNO_3 27, As_2S_2 27, S 27 & Sb_2S_3 19%; b) Realgar (As_2S_2) 30, S 20 & KNO_3 50%; used in traces for rockets; c) Chrysoidine 30, Auramine (yellow) 10, KClO_3 35 & milk sugar 25% (Izzo, p 235). Belgrano, p 632, gave Chrysoidine 9–30, Auramine yellow 34–10, KClO_3 33–35 & lattosio (milk sugar) 24–25%

V. *Composizione a fumo arancione* (Compn for orange-colored smoke) Chrysoidine 45, KClO_3 25, milk sugar 30 & mineral coal flour 5% (Izzo, p 235). Belgrano, p 632, gives HClE 20, Auramine 14, Red of p-Nitroaniline 23,

KClO_3 25, MgCO_3 4 & lattosio (milk sugar) 14%

W. *Composizioni a fumo rosso* (Red smoke compns) a) Red of para-Nitroaniline 60, KClO_3 20 & milk sugar 20%; b) Red of p-Nitroaniline 26, Rhodamine B 53 & KClO_3 21% (Izzo, p 236). Belgrano, p 631, gives Rhodamine 70, KClO_3 15 & milk sugar 25%; also HClE 30, Rhodamine 34, KClO_3 18, milk sugar 14 & MgCO_3 4%

X. *Composizioni a fumo verde* (Green smoke compns) a) Auramine yellow O 15, Indigo 26, KClO_3 33 & milk sugar 26%; b) Auramine yellow O 10, Indigo 20, KClO_3 30, milk sugar 20 & malachite green oxalate 20% (Izzo, p 236). Belgrano, p 632, gives HClE 31, Green of Malachite 35, KClO_3 16, milk sugar 14 & MgCO_3 4%

Y. *Composizione a fumo azzurro* (Blue smoke compn). Formulation of Izzo: Indigo 50, KClO_3 30 & milk sugar 20% (Izzo, p 236). Belgrano, p 632, gives Indigo 40–50, KClO_3 25–30, milk

sugar 15–20 & Methylene Blue 20 or 0%

Z. *Composizioni a fumo nero* (Black smoke compns) a) Hexachloroethane 50, anthracene 15, naphthalene 15 & Mg powder 20% (Izzo, p 236 & Belgrano, p 631); b) HCIE 65, anthracene 6, α -naphthol 17 & Al powder 12%. They were used in Italian smoke bombs (bomba fumogena) initiated by a mixture of KNO_3 61, S 17.5, As_2S_2 17.5 & gum arabic or dextrin 4% (Izzo, p 236) and c) KClO_3 31, naphthalene 11, red P 11 & tar 47%; d) KClO 45, naphthalene 40 & charcoal 15% (Izzo, p 237)

Z₁. *Composizione a fumo viola* (Violet smoke compn) 1-methylaminonitroquinone 18, 1,4-diamino-2,3-dihydroanthraquinone 26, KClO_3 30.2, S 11.8 & Na bicarbonate 14% (Belgrano, p 632)

Accdg to Gen Izzo (Ref 12, p 200), the principal Italian factories manufg pyrotechnic compns and items were, as of 1950, as follows: Polverifici Stacchini di Roma, la ditta Camocini di Como, la Mugnaioni, la Società ACNA, etc

The following Italian Military Pyrotechnic smoke compns used in colored smoke signal devices for air-to-air liaison were described by J. Goldenson & C.E. Danner in Chem & Engrg News 26, 1976–78 (1948):

Red – KClO 26, lactose 27, Sudan IV 27, Rhodamine B 14, Auramine 5 & sucrose 1%

Yellow – KClO_3 30, "Auramine O" 65 & kieselguhr 5%

Green – KClO_3 27, lactose 25, dimethylaminoazobenzene 21 & 1,4-di-p-toluidinoanthraquinone 27%

Black – KClO_3 60, naphthalene 20 & α -MN-Naphthalene 20% (Ref 28, pp 342–43)

Following is addnl information given in the book of Belgrano (Ref 31)

I. *Miscela a luci colorate* (p 627), calcd in parts: a) White – KNO_3 70, pulverin 30, S 30 & Sb_2S_3 5 pts; b) Red – Sr nitrate 45, KClO_3 30, S 18, Sb_2S_3 6 & carbon 2 pts; c) Green – KNO_3 50, KClO_3 30 & S 10 pts; d) Yellow – KNO_3 60, NaNO_3 10, S 22 & carbon 4 pts; e) Violet – KClO_3 42, Sr nitrate 18, S 30, calomel 5 & CuCO_3 5 pts and f) Blue – KClO_3 50, Cu nitrate 25, carbon 15 & S 5 pts

II. *Miscela illuminanti compresse* (Ref 31, pp 629–30)

a) Mg 43, Na nitrate 47 & binder (laminac) 10%. For its initiation use 75 pts of above

mixture with 25 pts of Black Powder. When compressed at 150 atm, its luminosity is 600000 candles

b) Mg 55, Na nitrate 33, Laminac 6 & Ba stearate 6%; luminosity 600000 candles

c) Mg 35, Al 5, Ba nitrate 52, Na oxalate 5.5 & oil 2.5%; luminosity 540000 candles

III. *Miscela innescante per fumogeni* (Initiating mixture for smoke compns) KNO_3 61, red arsenic 17.5, S 17.5 & gum arabic 4% (Ref 31, p 632)

PNP Esplosivo. A HE consisting of PETN 20, AN 77, & wax 3% has been used press-loaded as a bursting charge in various projectiles (Ref 26, p 160 & Ref 31, p 182)

PNT. Belgrano (Ref 31) lists it on p 267 without giving its compn

Polvere alla ftalide – centralite. See Polvere FC

Polvere alla nitrocellulose. See Polvere NAC

Polvere BPD (Belgrano-Parodi-Delfino Powder). See under Metriolo (Nitrometriolo)

Polvere bruna o Polvere cioccolata (Brown Powder or Chocolate Powder) contd KNO_3 79, incompletely carbonized wood as powder 18 & sulfur 3%; used in some cannons prior to the invention of smokeless propnts (Ref 1, p 147–8 & Ref 28, p 345)

Polvere C. Same as Cordite Italiana

Polvere C₂. See C₂ (Polvere)

Polvere C-12. See C-12 (Polvere)

Polvere "Cannel". A Cheddite-type expl contg Amm Perchlorate 80 & Cannel coal from Scotland 20% was proposed in 1900 by U. Alvisi as a blasting expl (Ref 1, p 200)

Polvere CG-13. A Ballistite-type expl contg NG 25, NC (N 12.5%) 60 & DNT (solid) 15% (Ref 11, Vol 2, p 139 and Ref 31, p 210)

Polvere CG-14. A Ballistite-type expl contg NG 25, NC (N 12.5%) 60, DNT (solid) 10 & Centralite 5% (Ref 4, p 183 and Ref 31, p 210)

Polvere FB o Polvere allo ftalato di butilo.

There are 860 and 960 calorie-types, which contd, respectively: NG 32 & 31, NC (12% N) 57 & 61, butyl phthalate 9 & 5.5 and Centralite 2 & 2.5%; used in rapid-fire cannons (Ref 11, Vol 2, p 148 & Ref 31, pp 206 & 208)

Polvere FC o Polvere alla ftalide-centralite.

There are 860 & 960 calorie-types, which contd, respectively: NG 28 & 32, NC (12% N) 64 & 62.5, phthalide, $C_6H_4.CH_2.O.CO$ 4 & 3.5, Centralite 3 & 1.5 and vaseline 1 & 0.5%; used in rapid-fire cannons (Ref 11, Vol 2, p 148 & Ref 31, p 206)

Polvere per mitragliatrice FIAT mod 35 e cal 8 (Propellant for Machinegun FIAT, Mod 35, Cal 8). See "Polvere italiana per cartucce cal 8, per mitragliatrici", under POLVERI DA LANCIO SENZA FUMO, item A. Polveri alla sola nitrocellulosa o Polveri a una base

Polvere NAC o Polvere alla nitroacetilcellulosa (Propellant with Nitroacetylcellulose). There are 860 & 960 calorie-types, which contd, respectively: NG 27 & 32, Nitroacetylcellulose (N 11.2%) 66 & 63, Centralite 7 & 4 and DPhA 0 & 1%; used in cal 20 & 37mm cannons (Ref 11, p 147 & Ref 31, p 206)

POLVERE NERA (Black Powder) o Polvere da fuoco (Fire Powder) (Abbreviated as BkPdr)

The latest Italian book describing Black Powder is that of Belgrano (Ref 31, pp 341-50).

Black Powders are subdivided into three types:

- 1) *Polvere da guerra* (Military Type) KNO_3 74-75, carbon 15-16 & sulfur 10%
- 2) *Polvere da caccia* (Hunting or Sporting Type) KNO_3 75-78, carbon 12-15 & sulfur 9-12%
- 3) *Polvere da mina* (Mining or Blasting Type) KNO_3 60-72, carbon 14-21 & sulfur 13-18%

The following average props of BkPdr are listed by Belgrano on p 349: Density (max) 1.7; Temperature of Explosive Decomposition 300° ; Temperature of Explosion 2700° ; Heat of Explosion 740cal/g, Specific Pressure 3250 atm/kg; Volume of Gas Developed on Explosion, calcd at STP 325 liters/kg; Trauzl Test value 30-40cc; Impact Sensitivity with 2kg Weight 70cm; and Velocity of Detonation 1400m/sec (See also Ref 28, p 345)

The principal Italian uses of Military BkPdrs are as igniters in percussion primers. For example, the Igniter of the 105/28mm cartridge case contd 25-30g of BkPdr & ca 5g of lead foil, serving as a decoppering agent (Ref 28, p 345)

Polvere al nitrodiglicol (Propellant with DEGcDN). Two types are described in Belgrano (Ref 31, p 208), 860 cal & 730 cal of compns, respectively: DEGcDN 68 & 27, Nitroacetylcellulose 30 & 63.5, acetylcellulose 0 & 5 and Centralite 2 & 4.5%

Polvere al nitrometriolo (Metriol Trinitrate Propellant). Three types are described in Belgrano (Ref 31, p 210), *M4*, *M6* & *M8* with compns, respectively: Metriol Trinitrate 55.5, 57.5 & 59%; NC 40, 36 & 33%; acetylmetriol 2.5, 4.5 & 5.9%; and Centralite 2, 2 & 2.5%

Polvere al trinitroanisolo—Stabilite. Two formulations are listed in Belgrano (Ref 31, p 210):
a) TNAns (Trinitroanisole) 40 & NC 60%
b) TNAns 34, NC 60, NG 5 & water 1%

Polvere verde (Green Powder). A Cheddite-type expl: KNO_3 66.7, PA 19.0 & $K_4Fe(CN)_6$ 14.3%; was used in blasting operations (Ref 28, p 346). Belgrano (Ref 31, p 356) lists this expl, but gives for KNO_3 39%, which is evidently in error

POLVERI DA LANCIO SENZA FUMO (Smokeless Propellants) o Polveri colloidali (See also Esplosivi da lancio o Deflagranti).

Giorgio (Ref 26, pp 204-08) subdivides them as follows:

A. Polveri alla sola nitrocellulosa a solvente volatile o Polveri a una base (Single Base Propellants with Volatile Solvent). To these belong a proplnt listed by Giorgio, p 205 as *Polvere italiana per cartucce cal 8 per mitragliatrice*, which contd: NC (12.8% N) 97, Centralite 2 & DPhA (Diphenylamine) 1%. It is in the form of tubes 0.75-.01 x 2mm, graphited. The same proplnt is listed by Belgrano (Ref 31, p 204) as "Polvere per mitragliatrice FIAT mod 35 e cal 8" (Propellant for Machinegun FIAT Mod 35, Caliber 8)

B. Polveri a doppia base (con NGL) [Double-Base Propellants with NG (Nitroglycerol)] are divided into:

a) *Polveri a doppia base senza solvente volatile* (Double-Base Propellants Without Volatile Solvent), called by Belgrano *Polveri a solvente fisso* (Propellants with Fixed Solvent). To these belong *Balistite normale o ordinaria* (with 50% NG); *Balistite a basso titolo* (with 42% NG) (Ref 26, p 205); *Polvere FB, Polvere FC & Polvere NAC* (Ref 31, p 206)

b) *Polveri a doppia base con solvente volatile* (Double-Base Propellants With Volatile Solvent), called by Belgrano (Ref 31, p 211) *Polveri a solvente misto* (Propellants with Mixed Solvent). To these belong *Polvere C₂* [described here as *C₂* (Polvere)], also known as *Cordite italiana* and *Solenite (qv)* (Ref 26, p 206)

C. Polveri a piu' componenti (Propellants with Several Components). Giorgio (Ref 26) lists on p 207 among them some propellants which are listed by Belgrano on p 206 under *Polveri a solvente fisso*. One of them, *Polvere alla Centralite*, listed by Giorgio on p 207, was not found in Belgrano. Its compn is NG 24, NC 69 & *Centralite I 7%*

Under the title "La preparazione delle polveri colloidal", Giorgio described on pp 209-10 the prepn of single-base and double-base propnlts

Under the title "Fabricazione delle polveri a solvente fisso", Belgrano described on pp 206-07 methods of prepn of double-base propnlts with fixed solvent

Under the title "Analisi sulle polveri di lancio", Belgrano described on pp 213-14 analytical procedures used for single-base and double-base propnlts contg as stabilizers DPhA, *Centralite*, etc

Polveri senza fumo. See POLVERI DA LANCIO SENZA FUMO

PRIETTO o PROIETTILE (Projectile)

Accdg to "MUNIZIONAMENTO ITALIANO" (Addnl Ref C), the terms *proietto* o *proiettile* are used referring to any heavy object which is fired from a gun and produces a destructive effect at a distance. This object may be solid (like an AP Bullet) or hollow (like HE Projectile) loaded with a bursting charge expl (carica di scoppio) which is detonated by an initiation train

Accdg to TM 9-1985-6 (1953) (Ref 16, p 61), Italian projs used during WWII were very

similar to British, French and Japanese. Most field equipment was semi-fixed, with the smaller caliber and AA (Antiaircraft) guns using fixed ammunition. When the semi-fixed type of ammunition was used, the propellant charge was divided into a number of parts which were enclosed in silk bags. Igniters of BkPdr were also included. The complete charge was enclosed in the cartridge case and closed by means of a cardboard cup. In the base of the cases were fitted percussion primers of standard design

In guns using bag ammunition, an igniter which had an extension piece was fitted into the vent hole. For initiation of propellant charges, the types of tubes used were friction, percussion, and electric percussion

The Italians designated their projectiles by the caliber, the specific equipment in which they were used and the model numbers of the projectiles. In most cases the model number indicated the year in which the item was designed

Accdg to MUNIZIONAMENTO ITALIANO (Addnl Ref C), *Proiettili Italiani* may be divided into: *Proiettili di piccoli calibri* (Small caliber projectiles, inclusive to 100-mm); *Proiettili di medi calibri* (Medium caliber projectile, from 102 to 210-mm) and *Proiettili di grosso calibri* (Large caliber projectiles, above 210-mm)

Projectiles may be classified also accdg to their effect on the target (*bersaglio*), as follows:

a) *Proiettili ad azione esplosiva*. Projs filled with HE's, which when initiated by the fuze blow up either during flight or on reaching the target (*Granate mine, Granate bombe, Granate torpedini and Granate scoppianti*) (Mine-, Bomb-, Torpedo- and Explosive Shells)

b) *Proiettili ad azione proiettiva* (Antipersonnel or Projecting Shells), which on bursting scatter splinters or pellets over more or less wide range and are designed to hit personnel or equipment. They may be called antipersonnel or fragmentation (*Granate ordinarie, Granate di ghisa acciai-osa, Granate dirompenti o a tempo e Granate a frattura prestabilita*) (Ordinary-, Steel-pig-, Demolition-, Time- or Predetermined Time Burst Shells)

c) *Proiettili speciali* (Special Shells). These include *incendiari* (Incendiary), *fumogeni* (Smoke), *nebbiogeni* (fog), *illuminanti* (Illuminating) e *proiettili carichi di aggressivi chimici* (CW Shells)

d) *Proiettili perforanti* (Armor-Piercing Pro-

jectiles, abbrd AP). They contain a small expl charge encased in specially treated steel. Used against tanks, ships and fortifications

e) *Proiettili semiperforanti* (Semi-penetrating Shells) contain a larger expl chge and, in addn to penetrating effect, they have an expl effect
 f) *Scatola a mitraglia* (Case Shot or Canister) consists of sheetmetal cylinders contg pellets cemented by resinous or similar binder. Used in close-range combat

g) Hollow (Shaped) Charge Projectiles (*Cariche cava*) are not described in AddnlRef C

There were also inert projectiles used for training purposes

Italian WWII projectiles are described and illustrated under "ITALIAN PROJECTILES AND CASES" in TM 9-1985-6 (1953) (Ref 16) and in "MUNIZIONAMENTO ITALIANO (AddnlRef C), also as complete rounds. We are describing rounds for small arms under *Armi portatili, munizioni*, while artillery ammunition is described and illustrated under *CARTOCCI GRANATA*, where many Hollow Charge (*Carica cava*) Shells are listed

PROJECTILE FUZES (Spolette per proiettili).

Accdg to *MUNIZIONAMENTO ITALIANO* (AddnlRef C), projectile fuzes may be divided by their location into *spolette anteriori* (Nose Fuzes) and *spolette posteriori* (Base Fuzes); and in terms of operation into *istantenee* (Instantaneous), *ordinarie* (Regular) and *ritardate* (Delay)

A number of fuzes used before WWII are known, but it is preferable to list here fuzes of WWII, which are described and illustrated in TM 9-1985-6 (1953) (Ref 16). The fuzes are divided into:

- a) Nose Percussion Fuzes (Field Equipment), *spolette percussioni*
- b) Nose Percussion Fuzes (Naval and Coastal Defense)
- c) Time Fuzes (Field Equipment), *spoletta a tempo* – Combustion Type and *spoletta meccanica a tempo* – Mechanical Type
- d) Time Fuze (Naval and Coastal Defense). *OT* – Nose Time Combustion Type and *OMT* – Nose Mechanical Time Type
- e) Time and Percussion Fuze *ADE*

Following are the fuzes described in Ref 5a: Percussion Nose Fuze for 65/17 HE Projectile

(p 134, Fig 201); Percussion Nose Fuzes M10 (Guerritore) PC and M (Guerritore) MEGC (p 135, Fig 202); Percussion Nose Fuze 1, M35 (p 136, Fig 203); Percussion Nose Fuze 1, M38 (p 137, Fig 204); Percussion Nose Fuze 1, M32/38 (p 137, Fig 205); Percussion Nose Fuze M40 with Detonator M40-Ordinary (p 138, Fig 206); Ditto – Instantaneous (p 138, Fig 207); Percussion Nose Fuze for 37/40 AP (p 139, Fig 208); Percussion Nose Fuze M39 (p 140, Fig 209); Percussion Nose Fuze OK BO SC 41 (p 141, Fig 210); Percussion Nose Fuze M16 (OK 25912) (p 141, Fig 211); Percussion Nose Fuze O BO 34/37 (p 142, Fig 212); Percussion Nose Fuze for 37/54 HE Shell (p 143, Fig 213); Nose Time Fuze M900/14 (p 144, Fig 214); Nose Time Fuze OT 32 (p 145, Fig 215); Time and Percussion Nose Fuze ADE M99 (p 146, Fig 216); Nose Time Fuze M06/17 (p 147, Fig 217); Time and Percussion Nose Fuzes ADE M06 (p 147, Fig 218); Time and Percussion Nose Fuze ADE M12 (p 148, Fig 219); Time and Percussion Nose Fuze ADE M36 (p 149, Fig 220); Time and Percussion Nose Fuze ADE M32 (p 150, Fig 221); Nose Time Fuze OT 33 (p 151, Fig 222); Mechanical Time Nose Fuze M36 (p 152, Fig 223); Base Fuze for 47/32 AP (p 153, Fig 224); Base Fuze for 100/17 Hollow Charge (*Carica cava*) (pp 153–54, Fig 225)

Propellenti (Propellants). See *Esplosivi da lancio*

Propellenti per razzi (Rocket Propellants). A brief description is given by Belgrano (Ref 31, pp 128–29). They are divided into *liquidi e solidi*. Liquids are divided into *monopropellenti* and *bipropellenti*, and monopropellenti are subdivided into three groups:

- 1) Those contg in its molecule both combustible and oxidizer, such as nitromethane, nitroethane, ethyl nitrate, NG, etc
- 2) Compounds which easily undergo exothermic decompn, such as hydrazine, acetylene, ethylene, etc
- 3) Synthetic mixtures of oxidizers with combustibles

Propellants used during WWII were usually liquid bipropellants, consisting of gasoline, aromatic amines and alcohol as combustibles with oxidants, such as liquid oxygen, hydrogen

peroxide or fuming nitric acid

Among *solid rocket propellants*, Belgrano mentions the mixtures of Na Nitrate & Amm Picrate with thermoplastic resin of urea-aldehyde type

Belgrano also mentions liquid propellant mixtures of hydrogen with light substances such as boranes of lithium or beryllium

It is not shown by Belgrano which of the above propellants were used by Italians

Addnl Refs from CA:

A. M. Pallotta of Bombrini-Parodi-Delfino S.p.A. (Società per Azioni), ItalP 640004 (1962) & CA 58, 11163 (1963) [Inhibition of Solid NC-NG base Rocket Propellants and/or sticking them to their container can be achieved by a mixt compatible with the ingredients of the propellant, eg, 2-Nitrodiphenylamine - it consists of a substance having ≥ 1 reactive HS groups, another having ≥ 1 unsatd monomers with 1 or 2 double bonds, and a substance or a combination of substances which promotes the copolymerization. The adhesion is stable betw -30° & $+50^\circ$. For example, a NC-NG based propellant contg 2-NDPhA and plasticizers was centered in a container of steel or Al. In the empty space, a mixt of 100 parts by wt of a polysulfide, $\text{HS}(\text{C}_2\text{H}_4\text{OCH}_2\text{OC}_2\text{H}_4)_{23}(\text{C}_2\text{H}_4\text{OCH}_2\text{OC}_2\text{H}_4\text{SH})$, 64 ps Me methacrylate, 20 ps TiO_2 , 1 p vinyl acetate, and 2 ps acrylonitrile was introduced. To this, 6 ps cumenehydroperoxide and 0.4 p diphenylguanidine were added. In <3 hours at RT, complete polymerization followed resulting in perfect inhibition and sticking of the grains]

B) R.M. Corelli (Univ Roma), Missili 4 (4), 13-24 (1962) & CA 60, 15672 (1964) [Development of high-energy chemical propellants which were classified into two groups: 1st group, consisting of liquid, solid, and hybrid (liquid, solid or lithergolic) propellants, is based on oxidn-redn reactions; 2nd group, based on the metastability of the substance, is the so-called free-radical group of high-energy fuels, primarily H, O, N, NH_3 , Me and Et. The liq propellants include O_2 , O_3 , F, boranes, dimethylhydrazine, and derivs of F & B. The solid propellants include thermoplastics (such as polyvinyl chloride), & polyethylene; the thermosetting compds (such as polyurethane, epoxy & polyester resins); and elastometers (such as polyisobutylene & Thiokol).

The free-radical group of fuels offers specific impulses much higher than conventional propellants, but handling problems appear to be insurmountable]

C) G. Partel, RivIng 15 (10), 969-76 (1965) & CA 64, 14015 (1966) (Nitric oxide, NO, tested in 28 expts as an oxidant in rocket propellants appeared to be unsuitable for that purpose, because it required a long reaction time inside the rocket engine. However, it could be used as regulator, when nitric acid is the oxidant)

D) D. Perfumo (of Bombrini-Parodi-Delfino S.p.A.), ItalP 696714 (1965) & CA 65, 16784 (1966) [In the manuf of solid rocket propellants of the extruded type, the action of plasticizers on the primary propellant is accelerated by the addn of small amts of N-alkylformamides (such as HCONMe_2). Processing temps can be low and primary plasticizers (such as alkylphthalates) can be omitted. In a typical prepn a propellant contg NC 61.5, NG 4, Nitroglycol 3, Amm Perchlorate 30.5 & Ethylcentralite 1%, was treated with a liq contg NG 62, NGc 34, Ethylcentralite 1, and HCONMe_2 3%]

E) Mario Giaccio (Univ of Pescara) Quad Merceol 7 (1), 63-87 (1968) & CA 71, 146 (1969) [Historical notes on solid propellants for rockets, from Chinese craftsmen to large-scale industry are given. Modern propellants (fuels and oxidizers) are included and future developments are discussed]

F) G.B. Guarise & G.A. Menin (Univ of Padova), AttiMemAccadPatarinaSciLettArti 1967-1968 (Pub 1969) 80 (Pt 2), 399-415 [Chem & mech characteristics of oxygen gas-JP-4 propellant mixts were detd in an exptl rocket engine. Details of expts and results, such as specific impulse & thrust limit are given]

Randite. A Cheddite-type expl contg KClO_3 42, MNBenzene 15 & MnO_2 43% (Ref 31, p 356)

Razzi (Rockets). No description is given by Belgrano except for *razzo antigradino* (Anti-hail Rocket). Its outside view is on p 626

RDX. See T₄

Romite. A Cheddite-type expl used for loading land mines: KClO_3 39, AN 49 & naphthalene or paraffin 12% (Ref 28, p 346 & Ref 31, p 356)

Sabuliti. Originally Sabulite, developed in Belgium and used as permissible (SPG) Dynamite, contd AN 54, K nitrate 22, TNT 6, Amm chloride 13 & Ca silicide 5%. The Italians modified it to AN 78, TNT 8 & Ca silicide 14% for use during WWI as a bursting charge in some ammunition (Ref 1, p 342). Then they replaced TNT (probably due to its shortage) by TNN (Trinitronaphthalene) and developed, accdg to Piantanida (Ref 4, p 246), the following compns for use as bursting charges: a) *Sabulite normale* - AN 60, Na nitrate 18, TNN 8 & Ca silicide 14% and b) *Sabulite extra* - AN 65, TNN 10 & Ca silicide 25%

All these compns are listed in Ref 28, p 346 and, in addition, there is *Sabulite 18* which contd AN 42, Na nitrate 40 & TNN 18%

Belgrano (Ref 31) stated on p 329 that Sabulite is a Belgian expl type SPG (*sécurité-grisou-poussière*), while on p 316 he stated that Sabulite consists of AN, Ca silicide & TNT with a Trauzl value of 255cc (See also Piantanida, Ref 4, p 246)

Saggio (Test), plural Saggi. The following stability tests are described in Belgrano (Ref 31): Saggio Abel (pp 64-7); Saggio Angeli (p 67) and Saggio di Bergmann-Junk o Saggio Tedesco (p 199)

Schneiderite. An expl mixture of AN 87.4 & DNN (Dinitronaphthalene) which originated in France and used during WWI as a bursting charge. It was adopted in Italy and in Russia. It was also used as a demolition charge. Its mixture with TNT is known as Esplosivo MST, described here as Nougat (Ref 4, p 241; Ref 28, p 346 & Ref 31, p 316)

Sebomite. A Cheddite-type expl: KClO_3 90, MNT 5 & tallow (sego) 5% (Ref 1, p 194)

Securite. A Dynamite which used to be manufd at Dinamificio di Segni: NG 52 & 30 and NC 48 & 70% (Ref 1, p 298). Belgrano (Ref 31, p 317) lists another *Securite* consisting of AN & m-DNBz (meta-Dinitrobenzene)

Sedulite. A Cheddite-type expl: KClO_3 85, MnO_2 5 & vaseline or paraffin 10% (Ref 1, p 198)

Seismic Explosives. See under Tutamite

Selenite Italiana. NG 36.0, Guncotton 30.5, Collodion Cotton 30.5 & mineral oil 3.0% (Ref 4, p 180)

Sevanite A. An expl mixt of French origin consisting of Amm Perchlorate 31, PETN 48, DNT 18 & Al 3%; density 1.55 & deton vel 5000m/sec (Ref 31, p 363)

Sevanite B. Amm Perchlorate 42, PETN 42 & DNT 16%; density 1.50 & deton vel 4500 m/sec (Ref 31, p 363)

Siperite o MNDT (Esplosivo). Accdg to Molina (Ref 1, p 342), Siperite was an expl compn consisting of AN 82-87 & DNN 18-13 parts, to which 20ps of TNN was added. Piantanida (Ref 4, p 242) gives: AN 72.8, TNT 16.7 & DNN 10.5%. Belgrano (Ref 31, p 297) gives its compn as AN 73, DNN 10 & TNT 17%. Accdg to Ref 28, p 347, it was used as a bursting charge for some projectiles

Small-Arms Ammunition. See ARMI PORTATILI MUNIZIONI

Solenite italiana o ordinaria. Accdg to Piantanida (Ref 4, p 180), it consisted of NG 36.0, fulmicotone 30.5, cotone collodio 30.5 & olio minerale 3%. Same compn is given by Belgrano (Ref 31, p 212) except that he lists pirocollodio instead of cotone collodio. It was used as a rifle proplnt for Fucile Mod 91 & Mannlicher (See also in this Vol of Encycl, p H152-R)

Solfite. Mixture of AN 83-88 & sulfur 17-12% proposed in 1930 by Dr Pannoncini. It is listed in Ref 28, p 347 and in Ref 31, p 317. Its use is not indicated

Solfocianato di piombo (Lead Thiocyanate), $\text{Pb}(\text{CNS})_2$, is described by Belgrano (Ref 31, pp 467-68). It was used in some initiating mixtures such as KClO_3 50-55, $\text{Pb}(\text{CNS})_2$ ca 25, Sb_2S_3 15-18 & $\text{Pb}(\text{N}_3)_2$ ca 5%

Solfuro di antimonio (Antimony Sulfide), Sb_2S_3 , has been used in many initiating mixtures contg

MF (Mercuric Fulminate) with KClO_3 , such as listed in two tables on p 423 of Belgrano (Ref 31)

Spoletta (plural **Spolette**). Fuze (Fuzes). See under Bomb Fuzes and under PROJECTILE FUZES

Stifnato di piombo (Lead Styphnate, abbrd as LSt) o **Trinitroresorcinato di piombo**,

$\text{C}_6\text{H}(\text{NO}_2)_3\text{O}_2\text{Pb}$ is described in Belgrano (Ref 31, pp 456-64). It has been manufd by the Società Nobel and used as an igniting charge for LA (Lead Azide) in detonators and as an ingredient in priming compns (Ref 28, p 350)

T₄, Esogene o Ciclotrimetilentrinitroamina (RDX, Cyclotrimethylenetrinitramine, Hexogene or Cyclonite). Its prepn, props and analytical procedures are described by Belgrano (Ref 31, pp 255-59)

Its props listed in Ref 31, p 259 are Density (max) 1.69, Explosion Temperature 230° , Flame Temperature at Explosion (Temperature of Explosion) 3380° , Heat of Explosion 1390kcal/kg, Volume of gas at 0° & 760mm 890 l/kg, Impact Sensitivity with 2kg Weight 30cm, Detonation Velocity 8400m/sec, and Trauzl Test Value 470cc. Giua (Ref 19) gave some slightly different values, such as Density (max) 1.70, Explosion Temperature 290° , Volume of Gas at 0° & 760mm 908 l/kg, Impact Sensitivity with 2kg Wt 42cm, Detonation Velocity 8380 m/sec and Trauzl Test 520cc (listed also on p 258 of Ref 31)

T_4 by itself is too sensitive to be used as a bursting charge in projectiles, but it is suitable for use in detonators & in blasting caps. When so used, T_4 is dissolved in cold acetone and precipitated by adding cold water to the soln. After filtering, the T_4 is dried in an aluminum-jacketed rotating drum thru which air preheated to 125° is driven. Then the dry particles are coated with 1% graphite to facilitate their press-loading in detonators

In a slightly desensitized form, as for example 95/5- T_4 /wax or paraffin, it is used as a booster charge in ammunition (Ref 28, p 348). Belgrano (Ref 31, p 261) calls such expl T_4 *flemmatizzato* and says that it is colored pink (rosa) in Italy. Other flemmatizzanti listed by Belgrano are NGu, DNT, mineral oil, castor oil, acetanilide, MNN

and synthetic resins

Mixtures of RDX with TNT, called *Tritoliti o Hexoliti* (qv), and with TNT & Al, called *Tritolital* (qv), are used as bursting charges. Other mixts contg RDX are Hexocire, Hexocire-Aluminum, Hexogene-Nylon and Idroliti are listed here

A mixture consisting of AN 73.4, RDX 22 & wax 4.6% was used, accdg to Ref 28, p 348, during WWII, as a bursting chge for some armor-piercing long-nose shells. A similar mixture called *NTP* (qv) is listed in Ref 31, p 266, as one of the *Miscela belliche polverulente a base di T₄*

Addnl Refs from CA:

A) Firm Rag. G. Mangiarotti, ItalP 528927 (1955) & CA 53, 3598 (1959) [Purification of a mixture of T_4 (RDX) and Tritolo (TNT) can be achieved by dissolving it at 45° in acetone, cooling to 25° and, after decantation, filtration, centrifugation and treatment with C or decolorizing earth, crystallizing in a vertical crystallizer. The crystals of T_4 which separate are continuously filtered out and TNT is separated from the mother liquor by pouring it into water or by evaporating the solvent]

B) G. Dini & G. Manfredi, ItalP 558782 (1957) & CA 53, 22956 (1959) [Details of conventional method of prepn of T_4 (Cyclonite or RDX) from hexamethylenetetramine (treatment with excess nitric acid), are claimed which make it possible to recover this excess directly in high concn]

T₄ plastico (Plastic RDX). One such is RDX 89 & vaseline 11%. By adding 10-20% of Al powder, the *T₄ plastico con alluminio* is obtd Ref 31, p 262)

In Ref 28, p 348, is listed a mixture contg RDX 78.5, DEGDN (with 0.3-0.4% of Colloid Cotton) 17.5 & vaseline 3%. This mixt is known as "Italian" and supersedes the so-called "American" mixture consisting of RDX 89 & petrolatum 11%, which is listed under *Esplosivo plastico*. The Italian mixt was used in land mines and in antitank bombs

Other RDX plastic expls are *Miscela C*, *Miscela C₃* and *Miscela C₄*. They are listed here and in Ref 31, p 263

T-Ammonal or Toluolammonal. See under Ammonal

Termite (Thermite). See under *Composizioni (o Miscela) Incendiarie* and in Belgrano (Ref 31, p 640) and Giua (Ref 19, p 414)

Tetralite. See TETRILE

Tetranitroanilina (Tetranitroaniline or TeNA). It is described in Belgrano (Ref 31, pp 271-72). Used in cryst form in some detonators and in mixts with TNT, TNN & DNBz

Tetranitropentaeritrite. See PENTRITE

Tetrazene o Guanilnitrosoammia (Tetracene or Guanyl nitrosoammine) is described by Belgrano (Ref 31, pp 464-67). Used in *Composizioni (o Miscela) innescenti*, items e, f, g and l

TETRILE, Tetranitrometilanelina, Trinitrofenilmetilnitroammia o Tetralite (Tetryl, Amer and CE, British). It is described in Belgrano (Ref 31, pp 272-75). He lists its uses in Gt-Britain and the USA but says nothing about its uses in Italy. In Ref 28, p 349 it is stated that it is used as a component of some expl mixtures, as with TNT, such as Tetrytol

Tetrytol (Tetrytol). Accdg to Belgrano (Ref 31, p 246), the mixture used in Italy consisted of Tetryl 75 & TNT 25% and was colored yellow. It was used for cast-loading in demolition charges

Tipo I and II Dinamite. See under DINAMITE

Titan. One of Ital mining expls. It is listed without giving its compn by Belgrano (Ref 31, p 317)

TNT. See TRITOLO

Tolite. See Tritolo

Tolulammonal. See under Ammonal

Torpex. Accdg to Belgrano (Ref 31, p 265), it is a mixt consisting of RDX 44, TNT 38 & Al powder 18%. Trauzl Test value is 490cc. It was used for loading warheads of torpedoes, depth bombs & sea mines

Tovex (Esplosivi "slurry"). Expl mixts contg

AN, Na nitrate, TNT, with or w/o Al and ca 15% of water were developed in the USA after WWII. Four formulations of Tovex are listed by Belgrano (Ref 31, p 322), who states on p 320 that slurry expls are not yet manufd, nor used in Italy

Tracianti (Tracers). See under PIROTECNIA

Trialen 105. An expl mixture similar to Torpex and Tritolital. It contd TNT 50, RDX 25 & Al 25%. Used in torpedoes and other underwater ordnance (Ref 28, p 349)

Trilite. See TRITOLO

Trinitroanilina o Picramide (TNA) is an explosive equal in power to PA (Picric Acid). Its props are described in Belgrano (Ref 31, pp 270-71) but uses are not indicated

Trinitroanisolo (TNAns) is described in Belgrano (Ref 31, pp 300-02). It was not produced in Italy industrially but studies were made in regard to its use for mining purposes. One of such mixts consisted of AN 80 & TNAns 20%. Incorporation of TNT in this mixt increased its brisance. It was used during WWII for military purposes by Japan, Germany & France (Ref 28, p 350)

Trinitrocresolo (TNCrs). Its isomer, *Trinitrometacresolo* (Trinitro-m-methylphenol) is described in Belgrano (Ref 31, pp 291-92). Was used in Italy in mixture: TNCrs 60 & PA 40%, under the name *Gesilite* (qv), for military purposes

Trinitrofenilmetilnitroammia. See Tetryl

Trinitrofenolo. See ACIDO PICRICO

Trinitrofloroglucinato di piombo (Trinitrofloroglucinate of Lead or Trinitro-1,3,5-trihydroxynate of Lead) is described in Belgrano (Ref 31, pp 475-76). Used in initiating compns and is considered by Belgrano to be better than LSt (Lead Styphnate)

Trinitroglicerina. See NITROGLICERINA

Trinitrometacresolo. See under Trinitrocresolo

Trinitrometaxilolo. See Xilito

Trinitronaftalina (TNN) is described in Belgrano (Ref 31, pp 298–99). It was used during WWI in mixture with TNT called *Tritrinal* (qv); also in some “esplosivi di sicurezza” (Safety Explosives) such as TNN 27, AN 27 & Na nitrate 58% (See also *Sabuliti*)

The higher deriv, *Tetranitronaftalina* (TeNN) has not been used on account of difficulty of manuf (Ref 31, p 299)

Trinitroresorcina. See Acido stiftico

Trinitroresorcinato di piombo. See Stifnato di piombo (Lead Styphnate, abbrd LSt)

Trinitrotolueno. See Tritolo

Triperossido di esametilentetramina o Esametilen-triperossidiammina. Italian names for Hexamethylenetriperoxidodiamine (HMTD) which is described in this Vol of Encycl, p H83-L. Belgrano (Ref 31) describes it on pp 478–79 without indicating its uses in Italy

Tritolital. Accdg to Ref 28, p 351 & Ref 31, p 263, it is a castable explosive used during WWII by Italians and Germans for loading underwater weapons, such as torpedoes, depth charges & sea mines. It consisted of TNT 60, RDX 20 & Al 20%. Its Trauzl test value is 400cc, deton vel 7400m/sec and brisance by Ital steel plate test (prova della piastra di acciaio) 21mm

Tritolite o Ciclotol. Accdg to Ref 28, p 351, it is a castable mixt of TNT 50 & RDX 50% proposed in 1930 by M. Tonegutti for loading underwater weapons, such as torpedoes, sea mines & depth charges. Its props are accdg to Ref 31, p 265: cast density 1.65, Trauzl value 460cc, deton vel 6900m/sec and brisance by Ital steel plate test 23mm. The compn was changed during WWII to TNT 60 & RDX 40%. Its props are cast density 1.62, Trauzl value 440cc, deton vel 6600m/sec and brisance 21mm, but the 50/50 formulation, being stronger, was used for loading aerial bombs and antitank shells (Ref 31, p 265)

The formulation RDX 60, TNT 39 & wax 1% is similar to Amer *Composition B*, which contd

1% paraffin (instead of wax). Its props are Trauzl test value 470cc and deton vel 6950m/sec. Was used in aerial bombs, armor-piercing shells, torpedoes and mines (Ref 31, p265)

Accdg to Ref 28, p 351, the following mixts were used during WWII for loading shaped charge shells and mines:

a) 50/50–RDX/TNT; b) 60/38/2–RDX/TNT/Wax (dyed red); c) 25/50/25–RDX/TNT/Al (Trialen 105) and d) 20/60/20–RDX/TNT/Al

The simplest method to prepare blends of RDX & TNT is to dissolve them in acetone and precipitate the powder by adding cold water

TRITOLO (*Trotile, Trilite, Tolite, Trinolo o Trinitrotoluolo*) (TNT or Trinitrotoluene). It is described in Belgrano (Ref 31, pp 233–47). TNT is manufd in Italy in two grades: 1) A.P. (alto punto) with solidification (setting) point above 80° and 2) B.P. (basso punto) solidifying between 77 & 78°

The following values for props of TNT are listed in Ref 31, p 241: Density (max) 1.58, Explosion Temperature 240°, Flame Temperature at Explosion 2800°, Heat of Explosion 980kcal/kg, Detonation Velocity at d 1.5 6700m/sec, Volume of Gas at 0° & 760mm 680liters/kg, Specific Pressure 8100atm/kg, Trauzl Test Value 285cc and Impact Sensitivity with 2kg Weight 90cm. Giua (Ref 19) gave some slightly different values such as density (max) 1.59, Explosion Temperature 295°, Volume of Gas 690liters/kg, Trauzl Test 310cc & Impact Sensitivity at 2kg Wt 60cm (listed also on p 258 of Ref 31)

Accdg to Ref 31, p 236, the grade of TNT solidifying above 80° was used straight in detonators and in some projectiles, while the lower grade (77–78°) was used in mixtures such as Amatol

Accdg to Ref 28, p 352, straight TNT has been used by the Italians to a much lesser extent than by the Americans or British. Pressed TNT is used as a booster in some bombs and as a main filler for some demolition charges. Granular TNT is used as the bursting chge of hand grenades, mortar shells and in mines. Cast TNT is used as a bursting charge in some bombs, 2 to 1000kg in weight, and for artillery shells, 57 to 420mm

TNT has also been used extensively in compo-

site expls, such as Amatol, Ammonal, Dinamon, Esplosivi da guerra, Esplosivi da mina, Esplosivo S20, Gomma incongelabile, MABT, MAT, MST o Nougat, Pentritolo, Pentrol, Picratol, Siperite or MNDT, Tetritol, Trialen 105, Tritolital, Tritolite, Tritonal and Tritrinal

Analytical procedures and tests used in Italy are described in Ref 31, pp 243-45

Tritonal. Composite explosive consisting of TNT 80 & Al powder 20%; Trauzl Test Value 350cc; used for cast-loading light case under-water ammunition (Ref 31, p 246)

Tritrinal of WWI. Composite expl of 1 part TNN (Trinitronaphthalene) and 2 parts TNT; used during WWI for cast-loading some ammunition (Ref 31, p 299)

Trotil. See Tritolo

Tutamite. One of the Italian "Esplosivi per prospezioni geosismiche" (Explosives for Geoseismic Prospecting) is listed by Belgrano (Ref 31, p 334) together with other Italian seismic expls *Sismite* and *Geo-Mon A*, without giving their compositions

Tutamite is also listed in Catalog of Montecatini SGIMC, Milano (1959), p 30. Its props are given but no compn

Geo-Mon A is listed in the same catalog, p 19 with props but no compn. Other Esplosivi per prospezioni geosismiche listed in Montecatini catalog are *Geo-Din A* and *Geo-Din B* (p 17)

In catalog of Vulcania SPA, Brescia, are listed three seismic expls: 1) *Vulcania DB*, based on TNT & nitric salts; Trauzl value 320cc, Deton Vel 2600m/sec at d 1.1 and Impact Test with 2kg Wt > 90cm; 2) *Vulcania DBS*, based on TNT, RDX & AN; Trauzl value 370cc, Deton Vel 5600m/sec at d 1.25 and Impact with 2kg Wt > 90cm; 3) *Sismite A*, based on TNT, Tetritol and nitrates; Trauzl value 400cc, Deton Vel 5000m/sec at d 1.4 & Impact Test 70cm

[Italian catalogs were obt'd thru the courtesy of Dr Omero Vettori of Aulla (Massa Carrara)]

Umbrite. Two formulations are listed by Belgrano (Ref 31, p 254): Umbrite A - NGu 48.4, AN 37.3 & ferrosilicon 14.3%; Trauzl value 260cc and Umbrite B - NGu 45.1, AN

41.4 & ferrosilicon 13.5%; Trauzl value 340cc. Accdg to Ref 28, p 352 they were used as bursting chges in some projectiles

Universal Italiana. Accdg to Belgrano (Ref 31, p 580), it is one of the *polveri da caccia* [Hunting (Sporting) Propellants], which was based on completely gelatinized NC. Molina (Ref 1, p 412) gives its compn as NC 80-82, DNT 12-10, DEDPhU (Diethylidiphenylurea) 4-4, vaseline 3-3 & volatiles 1-1%

UNKNOWN NAME EXPLOSIVES.

The following expls are extracted from Chemical Abstracts, A.M. Tonegutti, FrP 833720 (1938) & CA 33, 3590 (1939):

- A castable bursting type expl - AN 70, PETN 20 & cyanoguanidine 10%
- A press-loaded expl for use as a bursting chge for 47mm AP Shells - AN 73.4, RDX 22 & wax 4.6%
- A press-loaded expl for use as a booster in ammunition - RDX 95 & wax (dyed red) 5%
- A castable expl for use as a bursting chge in 500-kg bomb - PETN 65 & PETA (Pentaerythritol Tetraacetate) 35%. It is comparable to TNT in sensitivity to shock, but is about 25% less brisant

VE₄. One of the mining expls manuf'd by Vulcania SPA, Brescia, which is based on aromatic nitroderivatives and AN. Its Trauzl test value is 335cc & Deton Vel 3550m/sec at d 1.02. Suitable for use in quarries with rock not too hard (Vulcania Catalog of 1960, p not indicated)

Belgrano (Ref 31) lists VE₄ on p 317 without giving its composition

Vibrite. Blasting expl contg AN 78, TNNaphthalene 8 & Ca silicide 14% (Ref 1, p 342 & Ref 28, p 353) (Compare with Sabulite)

Victorite. Cheddite-type expl consisting of KClO₃ 40.0, PA 53.2, K (Na or Ba) nitrate 4.8 & carbon 2% (Ref 28, p 353)

Virite. Black Powder-type expl consisting of K nitrate 33-38, AN 35-40, sulfur 4-5, carbon 10-12 & Amm oxalate 9-12% (Ref 28, p 353 & Ref 31, p 340)

Vulcania DB and DBS. Seismic prospecting expls listed here under Tutamite

Vulcanite P. A mining expl suitable for blasting tunnels thru hard rock. It is based on inorg nitrates, nitroaromatic compds and nitric diethers. Its Trauzl test value is 515cc, Deton Vel 5100m/sec at d 1.15 & Impact with 2kg Wt 80cm [Catalog of Vulcania SPA, Brescia (1960)]

Vulcanite PR. A mining expl suitable for tunnel work thru hard rock. It is based on inorg nitrates & nitroaromatic compds. Its Trauzl value is 510cc, Deton Vel 5600m/sec at d 1.15 & Impact 70cm [Catalog of Vulcania SPA, Brescia (1960)]

Vulcan Powder. It is listed in Belgrano (Ref 31, p 339) as contg NG 30.0, Na nitrate 52.5, carbon 10.5 & S 7.0% without indicating which country used it

Xilite o Trinitrometaxilolo (TNX or Trinitro-m-dimethylbenzene). It is very briefly described in Belgrano (Ref 31, pp 248-49). It was used during WWI in mixtures with AN, such as in NX, contg AN 77 & xilite 23%. Another mixture was MTX which contd PA 55, TNT 35 & xilite 10%

References for Italian Explosives, Ammunition and Weapons:

1) R. Molina, "Esplosivi e Modo di Fabricarli", Hoepli, Milano (1930) 2) M. Giua, "Lezioni di Esplosivi", 2 Vols, Rattero, Torino (1932-33) 3) General Carlo Montu, "Storia dell' Artiglieria Italiana", Vol 1 (1935) [Reviewed in MAF 14, 557 (1935)] 4) E. Piantanida, "Chimica degli Esplosivi e dei Gas de Guerra", Regia, Accademia Navale, Livorno (1940) 4a) Lt Col G.B. Jarrett, Ordnance Sergeant, Aug 1943, p 18 5) Anon, "Data on Foreign Explosives", US Chemical Warfare Service Field Lab Memo 4-6-2 (1944), US Office of Technical Services PB Report 11544 5a) Lt Col G.B. Jarrett, "Italian Artillery", Field Artillery Journal 35, 663-71 (1945) 6) J.D. Parsons, "Visit to Italian Explosives Factories", PB Rept 12663 (1945) 7) Anon, "Explosives and Demolitions", US War Department Manual FM 5-25 (1945), pp 136ff (Italian Explosives) 8) Anon, "Italian and French Explosives", US

Navy Dept Bur Ordn OPNAV 1668 (1946), pp 1-27 9) A. Mangini, "Quaderni di Chimica Industriale 14; Esplosivi", Patron, Bologna (1947), pp 147-235 10) Col A.D. Merriman, "Italian Bombs and Fuzes", British Ministry of Supply Monograph 17-805 (1948) 11) C. Caprio, "Corso di Esplosivi", Scuola Salesiana Libro, Roma, Vol 1 (1948) & Vol 2 (1949) 12) A. Izzo, "Pirotecnia e Fuochi Artificiali", Hoepli, Milano (1950) 13) C. Belgrano, "Gli Esplosivi", Hoepli, Milano (1952) 14) Ministero, de la Difesa Marina, Editore, "Guida per l'Esecuzione delle Prove Pratiche o della Analisi sugli Esplosivi", Roma (1952) 15) A. Izzo, "Manuale del Minatore Esplosivista" (Fochino), Hoepli, Milano (1953) 16) Anon, "Italian and French Explosive Ordnance", US Dept of the Army TechManual TM 9-1985-6 (1953), pp 1 to 176 17) G. Castelfranchi & P. Malatesta, "Lezioni di Chimica di Guerra", Part 1: "Esplosivi", Pt 2: "Aggressivi Chimice", Edit Studium, Roma (1954), 640pp 18) B.T. Fedoroff et al, "Italian Explosives and Ammunition", Picatinny Arsenal Mnauscript, Unpublished (1955) 19) Michele Giua & Maria Luisa Marchino, "Esplosivi", pp 1-497 in "Trattato di Chimica Industriale", 6 (1°) UTET, Torino (1959) 20) Major T.H. Reynolds, "The Munitions Industry, Bombrini-Parodi-Delfino", US Military Intelligence Report R-720-59 (1959) 21) P.B. Tweed, "Report on Trip to Europe During May 1960", Picatinny Arsenal Technical Memorandum Report ORDEB-TE9-28 (1960) 22) R.P. Antonelli, "Encyclopedia of Explosives", OTIA, Ordnance Liaison Group, Durham, North Carolina (1960), pp 150-51 (Italian Terms) 23) W.H.B. Smith & J.E. Smith, "Small Arms of the World", Stackpole, Harrisburg, Pennsylvania (1960), pp 476-97 (Italy) 24) B.T. Fedoroff & O.E. Sheffield, "Encyclopedia of Explosives and Related Items", Picatinny Arsenal Technical Report PATR 2700, Vol 1 (1960); Vol 2 (1962); Vol 3 (1966); Vol 4 (1969); Vol 5 (1972) and Vol 6 (1974) (Pages indicated under each item) 25) L. di G. Pirola, "Esplosivi", Collezione Legale Pirola No 1187, Milano (1962) 26) C. Giorgio, "Tecnica degli Esplosivi", Vol 1, Del Bianco, Udine (1964) 27) E. Brandimarte, "Teoria dell'Esplosione ed Esplosivi di Scoppio", Accademia Navale, Livorno (1965) 28) O.E.

Sheffield, "Handbook of Foreign Explosives", US Army Materiel Command Intelligence Document **FSTC 381-5042** (1965), pp 318 to 359
 29) E. Brandimarte, Editor, "Le Cariche di Scoppio" (Bursting Charges), Accademia Navale, Livorno (1966) (Theoretical discussion dealing with shapes of bursting charges) 30) M. Busco, "Ottica Geometrica degli Esplosivi", Vol 1 (1973) (Obtainable from author at Via Quatro Venti 247, Roma) 31) Camillo Belgrano, "Gli Esplosivi", 2nd Ed, Arti Grafiche Fiulane, Udine (1974). Introduction by General Attilio Izzo 32) Dr Omero Vettore, Aulla (Massa Carrara); private communications on Italian explosives during the years 1972-75

Additional References:

- A) US War Department "Military Dictionary", **TM 30-2569**, English-Italian and Italian-English, Washington, DC (1943)
 B) "Military Italian-Russian Dictionary", GosizdatInostr i NazionSlovarey, Moscow (1953)
 C) "MUNIZIONAMENTO ITALIANO" (1941) Sent by Dr Omero Vettori, Aulla (MC) in May, 1973
 D) Picatinny Arsenal Technical Reports (PATR) on examination of Italian Ammunition picked up at the front or captured:
 a) C.G. Scheibner, **PATR 903** (1938) (Cal .50 Expl Shell)
 b) A.B. Schilling, **1241** (1943) [47-mm AP, HE (LN) CRA]
 c) Ibid, **1258** (1943) [47-mm AP, HE (MB) CRA]
 d) R.M. Dennis, **1315** (1943) [47-mm HE (Tritolo) CRA]
 e) A.B. Schilling, **1327** (1943) (Stick-Type Land Mine)
 f) R.M. Dennis, **1332** (1944) (37-mm LE Shell CRA)
 g) Ibid, **1344** (1944) (81-mm HE Mortar Shell CRA)
 h) A.B. Schilling, **1348** (1944) (Variable Pressure Land Mine)
 i) Ibid, **1349** (1944) (20-mm AP, HE Shell Complete Round)
 j) Ibid, **1362** (1944) (81-mm HC, HE Mortar Shell CRA)
 k) Ibid, **1381** (1944) (Pressure Igniter and Demolition Block)
 l) F.G. Haverlack, **1515** (1945) (120/45-mm HE Shell)

- m) A.B. Schilling, **1539** (1945) (Offensive Hand Grenade)
 n) F.G. Haverlack, **1549** (1945) (149/13-mm HE Shell)
 o) A.B. Schilling, **PAMR 105** (1956) (Hand and Smoke Grenades with Friction Type Igniter)
 E) J.D. Parsons, "Visit to Italian Explosives Factories" (1945) (US Office of Technical Services, PB Rept **12663**)
 F) Anon, "Allied and Enemy Explosives", Aberdeen Proving Ground, Maryland (1946)
 G) R. Denti, "Dizionario Tecnico, Italiano-Inglese, Inglese-Italiano", Hoepli, Milano (1958)

Abbreviations: CRA - Complete Round of Ammunition; AP, HE, LN - Armor-Piercing, High Explosive, Long Nose; MB - Monoblock; HC - High Capacity; LE - Low Explosive

Italian Catalogs, furnished thru the courtesy of Dr Omero Vettori of Aulla (Massa Carrara):

I) Catalog of "Esplosivi ed Accessori da Mina", Montecatinni SGIMC, Milano (1959). Described are the properties and uses of mining expls designated as **Gomma A**, **Gomma Agel**, **Gomma B.M.**, **G.E.O.M.**, **G.D. 1° M.T.**, **G.D. 1° M.B.**, **G.D.S.**, **Gelignite S.A.**, **Semigel A**, **Dinamon 1°**, **Dinamon S**, **Cava M**, **Grisoutina 13.20%**, **Grisoutina 10%**, **Tionite**, **Geo-Din A**, **Geo-Din B**, **Geo-Mon A** and **Tutamite**. No compositions are given. Also are described initiating devices, nonelectric and electric

II) Catalog of "Esplosivi Mangiarotti", Codroipo (Udine) (1960). Described are the properties, uses and testing of mining explosives designated as **BM.1**, **BM.as**, **BM.ac**, **BM.57**, **Super BM**, **BM.a2**, **Super BM.Cava**, **BM.2 per Galleria**.

Comps are given without numerical values
 III) Catalog of "Vulcania SPA. Polveri per Mina, Caccia, Agricoltura, Difesa", Brescia (1960).

Described are the properties and uses of mining expls: **Antonites**, **Alger C**, **Alger D**, **Alger E**, **VE₄**, **Vulcania D.B.**, **Vulcania D.B.S.**, **Vulcanite P**, **Vulcanite PR** and **Sismite A**. Comps are given without numerical values

IV) Catalog of "Sorlini Esplosivi SPA, Brescia (1961). Described are properties and uses of mining expls: **Martia Alpha**, **Martia Beta**, **Martia Gamma**, **Martia Delta 45**, **Martia Eta S**. No compositions are given

V) Catalog of SMI (Società Metallurgica Italiana) SpA "Catalogo Munizionamento Militare". At their plant near Campo Tizzoro (Province of Pistoia) the Co manufs Small Arms Cartridges, while at Fornaci di Barga (Prov of Lucca) Artillery Cartridges are manufd. The Co also manufs steel cartridges for Recoilless Rifles (Bossoli Acciaio per Cannoni Senza Rinculo), Percussion & Electric Primers (Cannelli a Percussione ed Elettrici) and other metallic items

VI) Professor L. Musciarelli, "Storia delle Armi" (History of Weapons) which includes History of Beretta Factory and Catalog of Pistols, Rifles & Shotguns. Published by Fabbrica d'Armi Pietro Beretta, Milano

Ivory Nut (Corajo, Coroso or Vegetable Ivory). A hard white substance obtained from the tagud nut, such as *Phytelephas Macrocarpa* or negro palm, which grows in Ecuador

It is composed of cellulosic bodies and other hydrocarbons

In powdered form, it is used as a "fuel" component of dynamites and other blasting explosives. According to Marshall (Ref 1), such material should not contain more than 5% of moisture and 3% ash; its solubility in 95% alcohol should not exceed 3%

Ivory nut meal used in US dynamites is usually either fine (No 1), which has about 5% remaining on No 20 sieve and 30% passing No 100 sieve, or coarse (No 2) with 5% remaining on No 10 and 5% passing No 60. The percentage of ash in both cases is below 5% and moisture below 10%. Absorption value: 30-35%

for the fine and 25% for the coarse. Densities are 0.80 to 0.90 for No 1 and 0.5 to 0.7 for No 2. Oxygen balance to CO_2 is about -115% for the dried material

Refs: 1) J. Patterson, JCS 1923, 1139 & CA 17, 2566 (1923) 2) Marshall 3 (1932), p 230 3) Hackh's (1944), pp 256 & 460; (1972), 178 & 364

Ivory Nut, Nitrated. No specs or procedures for nitration were found. Its use in the following Dynamite compn is claimed by Stine (Ref 1): NG 35, NC 1, Nitrated ivory nut 5, NaNO_3 52 and Woodmead 7 parts. The nitrated ivory nut is insol in NG and its use as a substitute for an equal amt of NC produces an explosive which is more easily detonated

Nitrated Ivory Nut is also claimed (Ref 2) as an explosive by itself or a constituent of primary or secondary charges containing other explosives, such as MF, LA, TNT etc

Refs: 1) C.M. Stine, USP 1143330 (1915) & CA 9, 2313 (1915) 2) E. Marks, BritP 124303 (1919) & CA 14, 2713 (1920)

Izod Test. See Charpy and Izod Tests in Vol 2, p C154-L

Izzo, A. Author of Manual del minatore esplosivista. Milan: u Hoepli (1953) 189pp. Reviewed in Chem & Ind 71, 1173 (1954) & CA 48, 11062 (1954)

J

J (Poudre de chasse): A French smokeless sporting propellant invented by Bruneau and manufactured before WWI. It contained NC 83 & ammonium bichromate 17%. It replaced poudre pyroxylé type S
Refs: 1) Daniel (1902), p 385 2) Pascal (1930), p 228

Jablonsky's Propellant. Two samples of propellant powder were submitted by Dr Frans Jablonsky for tests as to suitability for use in small arms ammo. The powder was stated to contain NC recovered from scrap moving picture film & other chemicals intended to increase the oxygen content. Chem analysis showed the samples to have the following composition:

Composition, %	Sample No 1	Sample No 2
Nitrocellulose	76.26	74.08
Ammonium Picrate	13.82	10.89
Potassium Chlorate	5.40	7.75
Camphor	3.46	3.54
Ethyl Acetate	0.86	3.74
Red org material	0.20	—

Tests showed the propellants to be of relatively low stability, unduly volatile & hygroscopic. Ballistic tests gave results indicating the propellants to have less ballistic potential than Pyrocellulose, and to deposit unburned residue in the rifle barrel. The propellants, represented by the two samples, were considered to be of little promise for use in military ammo

Ref: A.J. Phillips, "Study of Propellant Powder Submitted by Dr Frans Jablonsky", **PATR 796** (Jan 1937)

Jacket. A cylinder of steel covering & strengthening the breech end of a gun or howitzer tube. It also refers to the water jacket on some machine guns

Ref: OrdTechTerm (1962), p 168-L

Jacket, Bullet. A metal shell surrounding a metal core, the combination comprising a bullet for small arms. The jacket is either composed of, or coated with, a relatively soft metal, such as gilding metal, which engages the rifling in the bore, causing rotation of the bullet
Ref: OrdTechTerm (1962), p 168-L

Jacket, Coolant. The metal enclosure that consists of an inner wall (liner) and an outer metal wall (outer case), with a coolant passage between them, occasionally held apart by spacers or coolant helices. Term also applied to the double metal walls of a regeneratively-cooled thrust-chamber assembly

The main component of a modern liquid-propellant rocket thrust-chamber assembly is called the coolant jacket. There are many jacket designs but, in nearly all cases, the jacket structure extends thru the throat region as well as the combustion chamber

Ref: J.W. Herrick & E. Burgess, "Rocket Encyclopedia Illustrated", Aero Publ, Los Angeles, Calif (1959), p 240

Jacketed Projectile. In order to take advantage of the increased striking energy made possible by the use of a smaller caliber, higher vel, perforating missile, designers have made use of the principle of the subprojectile as shown in the Fig. Here the jacket around the smaller tungsten

IDEALIZED PROJECTILE TYPES

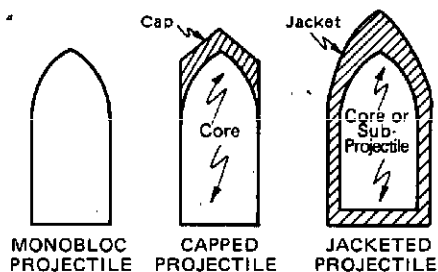

carbide core, or subprojectile enables the missile to derive full benefit of the propellant powder gases. Further, since the jacket or carrier is made of Al, the lighter over-all wt of the complete projectile coupled with the use of high potential propellants results in a higher muzzle vel. Unfortunately, the decrease in over-all wt, while helping to give greater muzzle vel, also results in a lower ballistic coefficient and, therefore, a higher rate of loss of the muzzle vel. Since the jacket is rigidly attached to the core and does not fall off until contact with the target, the HVAP (hypervelocity armor-piercing)

is also known as the composite rigid or compo-rigid type

Ref: *ArmamentEngrg* (1954), pp 208-09

Jacqué Stability Test. Jacqué, director of the Spanish plant Cantabrica at Guldácana, near Bilbao, proposed a test for NC which was simple, rapid, and did not require complicated apparatus. It is not advisable to use this test when it is known in advance that the NC is of low stability
Procedure. A NC sample of 2-3g, previously dried in a loosely covered weighing dish or crystallizer to constant wt, is transferred to an oven maintained at 130-40° and left there for 2 hrs. It is cooled in a vacuum desiccator and reweighed. The sample is again heated at 140° and weighed at intervals of ½-2 hrs until it decomposes, as indicated by an abnormal loss of wt. After termination of the test, it is advisable to wash the NC with distilled water, add a few drops of 0.1N KMnO₄ soln and determine the amt of HNO₃, either by the nitron or diphenylamine method

A somewhat analogous test is described by Sy [(*JACS* 25, 549 (1903))] and by Berkhout [*SS* 17, 33 (1922)]. See also Heat Tests in Vol 1 of *Encycl*, p XV

Refs: 1) M. Jacqué, *SS* 1, 395 (1906) & *CA* 2, 1346 (1908) 2) Reilly (1938), p 85

Jahnite Powders. Austrian mining expls patented by Jahn many years ago. They contained NaNO₃ 70-75, sulfur 12-10, lignite 17-10, KClO₃ 0.4-2, Na Picrate 0-3, PA 0.3-0 & NaCO₃ 0.3-0%

Refs: 1) Cundill (1889) in *MP* 6, 19 (1893)
2) Daniel (1902), 387-88

Jalnias Powders. The following compns for
Cannon Powder - KNO₃ 75, Na Picrate 3, sulfur 10, coal 10 & KClO₃ 2% and
Rifle Powder - KNO₃ 15, Na Picrate 8, sulfur 10, coal 15 & KClO₃ 2% are found in Ref
Ref: Pérez Ara (1945), p 223

JANAF. Abbr for Joint Army-Navy-Air Force (often pronounced as one word)
Ref: *OrdTechTerm* (1962), p 168-L

Janite. A large grain, black blasting powder impregnated with NG. It was used to a limited extent for excavation work on the Isthmus of Corinth in Greece

Ref: Daniel (1902), p 386

JANNAF. Abbr for Joint Army-Navy-NASA-Air Force (often pronounced as one word) established in 1969. Its activities are described in Ref

Ref: *Expls & Pyrots* 6 (2), 1973

Jannopoulos Test. A stability test for expls which is a modification of Abel's Test (See Vol 1 of *Encycl*, p A2-L) and of Guttman's Test (See Vol 6 of *Encycl*, p G196-L). The finely ground sample is previously warmed to 35-38° for four days before testing. The test is not applicable to double-base proplnts contg NG
Ref: Reilly (1938), p 78

Janovsky Test. Color reactions produced by treating aromatic nitro compds with hot & cold alcoholic NaOH or KOH and acetic NaOH solns. A table of color reactions of some nitro compds is given in Ref 2. See *Janovsky's Reagent* under COLOR REACTIONS and COLOR REAGENTS in Vol 3 of *Encycl*, p C405-R

Refs: 1) J.V. Janovsky, *Ber* 24, 971 (1891)
2) G.D. Parks & A.C. Farthing, *JChemSoc* 1948, 1278

JAPANESE EXPLOSIVES, AMMUNITION AND WEAPONS

Accdg to Ref 5, p 360, the Japanese used during WWII a greater variety of HE's (High Expls) and ammunition than other nations at the time (except probably the Germans and Italians). This was due to a shortage of raw materials necessary for the manuf of the best expls. Although they used many standard HE's (such as TNT, Picric Acid, PETN, RDX and Tetryl), every other available expl substance was also used as an ingredient of expl compns. Among these substances may be mentioned the following: TNAns (Trinitroanisole), TNPhT (Trinitrophenetole), HNDPhA (Hexanitrodiphenylamine), GuN (Guanidine Nitrate), DNN (Dinitronaphtha-

lene), DNBz (Dinitrobenzene), AP (Ammonium Picrate), as well as a number of commercial expls, particularly Dynamites. As nonexplosive ingredients, the materials used included: inorganic nitrates, chlorates & perchlorates; aluminum, silicon carbide, ferrosilicon, petroleum, woodpulp, powdered coal & charcoal, tars, waxes, oils and their mixtures

The Japanese Initiating Agents were similar to those used by the Germans, except that Tetracene was not used and fewer mixts were employed in ammunition. MF (Mercuric Fulminate) was used in many primary mixts, while LA (Lead Azide) was used in fewer mixts. It does not appear that LSt (Lead Styphnate) was used in compns contg nonexpl ingredients. As a base ingredient of detonators, PETN was mainly used and to a lesser extent, Tetryl

As to Japanese ammunition itself, one can point out the great variety of improvised devices, such as Mines & Depth Charges made from wooden boxes, burlap bags with rubber lining, & oil drums; Grenades made of pottery, glass & gas pipes; Booby Traps made of tin cans; and Bangalore Torpedoes made of bamboo tubes

Accdg to Refs 2 & 3, the Japanese Explosive Ordnance used during WWII was subdivided into those used for the Army (*Rikugun*) and those for the Navy (*Kaigun*)

System of Designation

1. Type Number. Item of Ordnance, as well as most other items of military equipment, were given a type number indicating the year the article was finally adopted for service use. Until the reign of the present Emperor (Showa era, started in 1926), items were designated by the year of the era. Now, however, the year of the Japanese Empire (Japanese year 2600 corresponds to our 1940) could be used. For items introduced up to the year 2600, the last two numbers are used in the designation. Thus Type 99 means that the item was adopted in 2599 (our 1939). The year 2600 may be represented as Type 100 or Type 0, while the years 2601, 2602, etc are represented as Type 1, Type 2, etc

2. Exptl Ordn items were marked with the year of the Showa era during which the experiment was authorized

3. Ordn items authorized in the eras preceding the Showa era: namely, Taisho (1912-1926) and Meiji (1867-1912), were designated by the era

and the year of the era. Type II (Taisho)=1922; Type 41 (Meiji)=1908

4. The term *Model* usually indicated a change in basic design, while the term *Modification* represented minor changes in design or a change in the expl filling

Addnl explanation is given in the introduction to each Section, such as Bombs, Land Mines, Grenades, Projectiles, Rockets, Mortars, Fuzes, Firing Devices and Sabotage Devices

The Japanese explosives and related items are listed alphabetically in the pages which follow

Alphabetical List of Japanese Explosives and Related Items

Aerial Torpedo. Kurai

Akatsuki. An Ammonium Nitrate expl contg: AN 73-75, NG gel 5-6, cellulose 3-5 & other ingredients 14-9%. Detonation Velocity 3490m/s at density 1.0; Detonation Pressure (experimental) 42.3kbar, while the calculated value is 33kbar
Ref: K. Sassa & I. Ito, "Studies of Detonation Pressure Using Aquarium Technique", *Kôgyô-KayakuKyôkaishi* 32, No 6 (Nov-Dec 1971). Engl translation by Mrs Geti Saad of the US-BurMines (1972)

A(ko) or Type A (Explosive). See Otsu-B

Aluminum. See Aruminyumu

Ammonāru - Ammonal. Compn and specific uses are not known (Ref 5, p 361)

Ammonium Chlorate, used in "Brown Powder" of compn: Amm chlorate 51.5, Ba nitrate 34.5, TNNaphthalene with oil 8.2 & woodpulp 5.0% (adds to 99.2%). Found as a booster in bombs for demolition (Ref 1, p 32)

Ammonium Nitrate. See Ammon Shosanen

Ammonium Perchlorate was used in Karito (Army Expl), Kaishikuyaku (Army Expl) and in Type 88 (Navy Expl) & Type 4 (Navy Expl)

Ammonium Picrate. See Picurinsan Ammonia. Used in Type 1 Explosives (Navy Expls)

Ammon Shosanen. Ammonium Nitrate (AN)

Used in a number of commercial and military expl compns, such as: *Akatsuki, Ammonāru, Ammonyaku, Anbeyaku, Angayaku, "E" (Explosive), Keyaki, Kiri Nos 1, 2 & 3, Ko-Shoan Bakuyaku, Shin-Kiri, Shinkyoryoku, Shin-Toku-Shoan, Shoan-Bakuyaku, Shoan Bakuyaku Nos 104 & 201, Shoanyaku, Shobenryaku, Shonayaku, Shotoyaku, Type 4 Mk 2*, and others (Ref 5, p 361)

There have also been conducted research on the use of AN in Composite Propellants for Rocket Engines (Ref 5, p 361)

Ammonyaku. Army expl compn consisting of AN & charcoal. Japanese documents cite it as "substitute powder". It was never recovered by Americans (Ref 1, p 29; Ref 5, p 361 and Ref 6, p 8-3)

AMMUNITION (Danyaku)

Introduction

Ammunition and Weapons used by the Army (*Rikugun*) were in most cases different from those used by the Navy (*Kaigun*). For this reason it is necessary to indicate whether the item was used by the Army or the Navy

Accdg to OPNAV 30-3M (1945) (Ref 1, p 123), **Japanese Army Ammunition of WWII** was divided into the following groups:

- a) Small Arms Ammunition – items smaller than caliber 20-mm
- b) Aircraft Cannon Ammunition – items of caliber 20-mm and over
- c) Medium and Large Caliber Gun Ammunition – items of 20-mm and over
- d) Mortar Ammunition
- e) Fuzes

Under the title "Japanese Ammunition—Explanatory Notes", **TM 9-1985-5** (1953) (Ref 3, p IV), the following information is given:

The *Japanese Army Terminology of WWII* for projectiles conformed fairly well with US custom. The abbrn AP indicated a projectile intended for piercing heavy armor, such as armor plate of thickness equal to or greater than the caliber of the projectile. These projs had a small HE bursting charge. Abbrn AP-HE indicated a solid-nosed proj in general similar to AP but designed for much lighter penetration.

They contd larger HE charges than AP and smaller than standard HE projs

There were "old" and "new" color systems for marking the Army projectiles, and they are briefly explained on pp 266–69 of Ref 3

The following abbrns are used in this Section on AMMUNITION:

AAMG	– Antiaircraft Machine Gun
AC	– Aircraft Cannon
ACMG	– Aircraft Machine
Ammo	– Ammunition
AP	– Armor-Piercing
AP-HE	– Armor-Piercing—High Explosive
API	– Armor-Piercing Incendiary
APT	– Armor-Piercing Tracer
ATk	– Anti-Tank
BkPdr	– Black Powder
HE	– High Explosive
HEAT	– High-Explosive Antitank (Shaped Charge)
HEI	– High-Explosive Incendiary
HEIT	– High-Explosive Incendiary Tracer
HET	– High-Explosive Tracer
HMG	– Heavy Machine Gun
How	– Howitzer
I or Incend	– Incendiary
IT	– Incendiary Tracer
LMG	– Light Machine Gun
MG	– Machine Gun
MK	– Mark
Mod	– Modification (or Modified)
Proj	– Projectile
Proplnt	– Propellant
SD	– Self-Destroying
Tk	– Tank
WP	– White Phosphorus

Ammunition, Army (Danyaku Rikugun)

Accdg to **TM 9-1985-5** (1953) (Ref 3, p 265), such ammunition and weapons were generally copies of German and French designs or were developed following their customs. In comparison with items used by other countries in the years preceding WWII, the Japanese ammo and weapons appear to be outmoded. This is particularly true in considering Small Arms (*Shōkahei*) because there is little evidence that they were standardized. The weapon used prior to 1930 was 6.5mm, but shortly thereafter it was superseded by cal 7.7mm, but the change was not complete and many 6.5mm

items were used during WWII

The foreign influence in design was particularly evident after 1939 when Aircraft Cannons (*Kōkūki taihō*) of German and Italian design were copied. The largest Aircraft Cannon devised was 120mm, but nothing larger than 57mm was ever put in service use

Most Infantry Artillery Weapons (*Hōheihō*) were characterized by their immobility, as very few of them were designed for rapid motor transport. The standard Field Piece (*Yahō*) was 75mm, although 105mm and 150mm were frequently encountered

One outstanding characteristic of Japanese armament was the large variety of type and sizes of Mortars (*Kyūhō*) in use. They were used not only as Infantry (*Hohei*) support weapons but also as Artillery Pieces (*Hō*). They ranged in size from the 50-mm Grenade Discharger (*Tekidantō*) to the 320-mm "Spigot" Mortar ("Spigot" *Kyūhō*)

The standard Antiaircraft Gun (*Kōshahō*) was a 75-mm Gun, but there was also an 88-mm AA Gun which was one of their most effective weapons and a 105-mm AA Gun. The Japanese also designed a 150-mm AA Gun for the defense of the home islands, but this was used only in the last few months of WWII

The newest trend in research and development in ammunition was along the line of Rockets (*Roketto*). Very few types were used during the war, but there were many experimental models of Antitank (*Taisensha*) and Artillery (*Hōhei*) Rockets, ranging in size from 75mm to 60cm

Research was also conducted on Smooth-bore (*Kakkō no*) and Recoilless (*Hihandō*) Weapons (*Mu-Handō*), but none of them was developed during the war beyond the experimental stage

The following Items of *Japanese Army Ammunition* are described, including illustrations, in TM 9-1985-5 (1953) (Ref 3, pages indicated under each item):

- Type 38 6.5-mm Ammo for Rifle, Carbine and Light MG; used single-base graphited proplnt (pp 270-71)
- Type 99 7.7-mm (Rimless) and Type 92 7.7-mm (Semi-rimmed) for MG's (pp 274-75)
- 7.92-mm Aircraft MG Ammo (p 277)
- 8-mm Pistol and 9-mm Pistol Ammo (pp 277-78)

-12.7-mm AC Cannon Proj contd PETN & Incend chge (pp 278-79)

-Type 97 & Type 98 20-mm Ammo contd single-base proplnt; no info about filling of proj. Used in A/Tk and AA-A/Tk Guns (p 280)

-20-mm HE Tracer, Type 98 HET and Type 100 HET Projectiles contd RDX and Tracer compn (pp 281-82)

-20-mm HE Incendiary and 20-mm HEI (Ma 201) Projs contd RDX or PETN and Incendiary (pp 282-84)

-20-mm HEIT Ammo for use in Ho-1 & Ho-3 AC Cannons. Its proj contd RDX, Incendiary & Tracer (p 284)

-Type 100 Mod 2 20-mm IT, SD Ammo for use in Type 98 AC-A/Tk Gun. Its proj contd Incend and Tracer compns but there is no HE except in Booster (p 285)

-20-mm APT Ammo for Type 97 A/Tk, Type 98 AA-A/Tk, Ho-1 & Ho-3 Guns. Its proj contd 7.0g of Tracer compn (pp 285-86)

-Ho-5 20-mm AP Ammo for use in Army AC Machine Gun. Its proj was solid steel shot and proplnt consisted of graphited cylindrical grains of single-base pdr (p 286)

-Type 2 and Type 2 Mod 20-mm HEI Ammo. The projs contd Cyclonite and Incend compn (p 287)

-Type 4 20-mm HEI (Ma 202) Ammo. Its proj contd PETN and Incend compn contg Ba nitrate, Al pdr, Mg pdr & wax (pp 287-88)

-Type 2 20-mm APT Ammo. Its proj contd 7.0g of Tracer compn (pp 288-89)

-37-mm HEI Ammo for use in Ho-203 AC Cannon. Its proj contd Cyclonite & Incend compn; proplnt consists of 59.8g of flat 4-mm squares poured loosely into brass case and sealed in with cardboard disc (pp 289-90)

-37-mm HEI Ammo for use in Ho-204 AC Cannon. Its proj contd Cyclonite/Wax and Incend compn; proplnt - 75.1g of the same type as above (pp 290-91)

-37-mm Army Ammunition for eight A/Tk and Tk Guns listed on pp 293-97 used the same type of projs filled with PA (Picric Acid), but different cartridge cases. They were for the following guns:

Type 11th Year Infantry Gun - 1.85oz of graphited proplnt in the form of flakes; they were poured into the case and sealed with a cardboard disc (pp 293-95)

Type 94 Tank Gun – 2.7oz of graphited proplnt in the form of rectangular flakes (pp 293 & 295)

Type 94 A/Tk, Type 98 Tank and Type 100 Tank Guns – 4.3oz of graphited proplnt in the form of unitubular grains contd in a silk bag (pp 293 & 295)

Type 97 A/Tk Gun – 5.0oz of graphited proplnt in the form of short, cylindrical grains contd in a silk bag (p 293)

–Type 94 37-mm HE Ammo had the proplnt as above and the forward 1/3 of the proj cavity filled with PA, while the after 2/3 of the cavity filled with cast TNT. Used in all 37-mm Guns (p 295)

–Type 94 37-mm AP-HE Ammo had the proplnt as above and the proj filled with PA; used in many A/Tk & Tank Guns (p 295)

–Type 1 37-mm HE Ammo had the proplnt as above and the proj filled with PA; used in Type 1 Tank & A/Tk Guns and also in Type 94 A/T Gun (p 296)

–Ho 301 40-mm HE Ammo for use in Ho-301 40-mm AC Cannon; had proj filled with TNT, contg in forward part a pellet of PA. The proplnt chge (0.4oz) consisted of small greenish-gray, square flakes (ca 1mm in size) enclosed in a silk bag (pp 296–97)

–Type 1 47-mm HE Ammo for use in Type 1 A/Tk and Type 1 Tank Guns. The filling (87g) of its proj consisted of two preformed paper-wrapped blocks taped together and wrapped. The forward block consisted of two pellets of PA – a ring pellet around the gaine and a solid pellet behind the gaine. The after block was one cast piece of TNT. Its proplnt chge (398g) consisted of single-perforated cylindrical grains of a graphited double-base smokeless proplnt contg NC 60.0, NG 34.5, EtCentralite 3.0 & Diphenylformamide 2.5% (pp 297–98)

–Type 1 47-mm AP Ammo for use in Type 1 A/Tk and Tank Guns. Its proj contd 18g of 90/10–RDX/paraffin and a Tracer compn. Used 398g of the same double-base proplnt as in HE Ammo (p 299)

–Type 90 5.7-cm (57-mm) HE Ammo for Type 90 and Type 97 Tank Guns. Its steel proj was filled with 250g of TNT and its proplnt was 113g of Mk 1 square grain (med) (p 300)

–Type 90 5.7-cm (57-mm) Ammo with Substitute Cast Iron Projectile was used in Type 90 and Type 97 Tank Guns. The proj was filled

with Black Powder and its proplnt was the same as in above HE Ammo (p 301)

–Type 92 5.7-cm (57-mm) AP Ammo was used in Type 90 & Type 97 Tank Guns. Its proj contd two sections of expl, individually wrapped in paper; upper section was pressed PA/Wax, while lower section was cast TNT. Proplnt was Mk 1 square grain (med) (p 302)

–Ho-401 5.7-cm (57-mm) Ammo for use in Ho-401 AC Cannon; no data are given for its proplnt and for filling of proj (p 303)

–Type 92 7-cm (70-mm) HE Ammo for use in Type 92 Infantry Gun (Howitzer). Its proj contd 590g of cast TNT (or pressed RDX/AN mixture). Proplnt (50g) was in square flakes contd in four pads made by sewing portions of the proplnt betw two dark blue silk discs. The sections were not uniform in size, holding 5.4, 8.9, 16.8 & 18.7g of proplnt each. The 5th disc, light blue in color, contd 3.1g of BkPdr serving as an ignition chge. The cartridge cases were of two designs; the newer type designated “B” (OTSU) was one-piece and slipped off the proj to change the proplnt chge; an older design, presumably “A” had a threaded base which could be unscrewed to vary the chge (pp 304–05)
Note: Its variety for use in Type 94 Tank Gun is shown on p 308

–Type 92 7-cm (70-mm) Ammo with Substitute Projectile for use in Type 92 Infantry Gun (Howitzer). Its proj was filled with BkPdr and its proplnt arrangement was the same as in 7-cm HE Ammo (p 305)

–Type 3 7-cm (70-mm) Hollow Charge Ammo for use in Type 92 Infantry Gun (Howitzer) as an A/Tk weapon. Its proj contd a Ho chge of cast TNT/RDX mixture wrapped in varnished paper; proplnt – same as in Type 92 7-cm HE Ammo (pp 305–06)

–Type 95 7-cm (70-mm) Illuminating Ammo for use in Type 92 Infantry Gun (Howitzer). Filling of proj consisted of ejection chge (BkPdr) and Illuminating chge, probably consisting of mixt of Mg & Al pdrs with Ba nitrate; proplnt – same as in Type 92 7-cm HE Ammo (pp 306–07)

Type 95 7-cm (70-mm) AP Ammo for use in Type 94 Tank Gun contains proj filled with 170g of preformed, paper wrapped HE’s: Ōshiyaku (qv) in forward portion and TNT in rear portion; proplnt was 120g of 5-mm square grain (medium) (p 309)

7-cm (75-mm) Army Ammunition. There were ten or more 75-mm (designated as 7-cm) guns in use. Although the weapons varied considerably in design, length of bore, and employment, the bore diam was held constant to 75-mm and the projs were designed to be interchangeable for numerous guns. In this case identical projs could be assembled with different sizes of cartridge cases and propnt charges to fit the various weapons

Ammunition for Navy guns designated "8-cm" have a bore diam 3 inches (76.2mm) and are not interchangeable with Army ammunition

Following are the 75-mm Army guns belonging to this group, as listed on p 311:

Type 41 Mountain (Regimental)

Type 94 Mountain Gun

Type 38 Field Gun

Type 41 Cavalry Gun

Type 38 Improved Field Gun

Type 95 Field Gun

Type 11 Year Field or AA Gun

Type 90 Field Gun

Type 1 Self-Propelled Gun

Type 88 Field Gun

Type 88 Field or AA (Special) Gun

Propellant cases for these guns are illustrated on pp 312-15 and complete rounds are listed in Table on pp 316-17

Following projectiles were used in the above guns:

7-cm (75-mm) HE-AA Proj filled with Ōnayaku (qv) was used in Type 11-Year Field AA Gun (p 318)

Type 90 7-cm (75-mm) HE-AA Long-Pointed Proj was filled with cast TNT (standard) and as alternate, PA. Used in Type 11-Year & Type 88 Guns (pp 319-20)

Type 90 7-cm (75-mm) HE, Long Pointed Projectile was filled with cast TNT (standard) or Heineiyaku (qv) as alternate. Used in Type 38 Field Gun Group (four weapons), Type 88 Field AA (Special) Gun, Type 90 Field Gun and Type 94 Mountain Gun (p 321)

Type 94 7-cm (75-mm) HE Proj was filled with TNT, while Angayaku and Heineiyaku were used as alternates; used in the same guns as above (pp 321-22)

7-cm (75-mm) Design "A" HE Proj contd 625g of Ōnayaku (qv); was used in Type 41 and Type 94 Mountain Guns and in Type 38

Field Gun Group (p 323)

7-cm (75-mm) Design "B" HE Proj contd Ōnayaku filling and was used in the same guns as above (p 324)

Type 98 Modified 7-cm (75-mm) HE Proj was filled with cast TNT and used in Type 41 Mountain Gun and Type 38 Field Gun Group (pp 325-26)

Type 90 7-cm (75-mm) HE Semisteel Proj was filled with cast TNT; was used in Types 41, 94, 38 & 90 Guns (pp 326-27)

Type 97 7-cm (75-mm) HE Semisteel Proj was filled with cast TNT; used in Type 41 Mountain Gun (pp 327-28)

Type 90 "A" 7-cm (75-mm) Substitute Proj was filled with BkPdr; used in Types 41, 94, 38 & 90 Guns (p 328)

Type 2 7-cm (75-mm) Hollow-Charge Proj contd 500g of cast 60/40-TNT/RDX wrapped in varnished paper; used in Type 94 and Type 41 Mountain Guns (pp 328-29)

Type 95 7-cm (75-mm) AP-HE Proj contd 460g of Ōnayaku; used in Types 41, 38, 90, 94 & 88 Guns (pp 330-31)

Type 1 7-cm (75-mm) AP Proj contd 53g of 90/10-RDX/Paraffin, coated with graphite and packed in an Al foil wrapper; used in Types 94, 41, 90 & 38 Guns (pp 331-32)

Type 38 7-cm (75-mm) Shrapnel Proj contd 100g of BkPdr as bursting chge together with lead balls; used in Types 41, 98, 38 & 90 Guns (pp 332-33)

Type 90 7-cm (75-mm) Shrapnel Proj contd 100g of BkPdr as bursting chge and ca 272 lead balls; used in the same Guns as above (pp 333-34)

7-cm (75-mm) Smoke (WP) Proj contd BkPdr as bursting chge and WP as chemical agent; no data for weapons (p 335)

Type 90 7-cm (75-mm) Smoke (WP) Proj contd 100g of Ōnayaku as bursting chge and 700g WP; used in Types 41, 94, 38 & 90 Guns. Its screening capacity was 20 meters high & wide and duration 1-2 minutes (pp 336-37)

Type 90 7-cm (75-mm) Incendiary Proj contd 20g of BkPdr as expelling chge and 530g as incendiary chge; used in the same guns as above (p 337)

Type 90 7-cm (75-mm) Illuminating Proj contd BkPdr as expelling chge and 250g of illuminating chge (probably a mixture of Al, Mg & Ba nitrate); used in the same guns as above (pp 338-39)

Type 11-Year 7-cm (75-mm) Target Proj contd folded parachute and shrouds in cardboard cylinder. After propelling the proj, the parachute became ejected by a small chge of expl, located in Time Fuze. Then the descending parachute and shrouds served as targets for AA practice; used in Type 11-Year AA Gun and in Type 88 Field AA Gun (p 339)

7-cm (75-mm) Liquid Incendiary Proj contd 40g of granular PA in paper container as bursting chge and soln of WP in CS₂ (300g) with rubber pellets (320g); used in Types 41, 94, 38 & 90 Guns (pp 339-40)

7-cm (75-mm) Vomit-Gas Proj contd 460g of 70/30-TNT/Naphthalene as bursting chge and 170g of Diphenylcyanarsine as liquid chemical agent; used in Type 41 Regimental or Mountain Gun (p 341)

Type 100 8-cm (88-mm) HE-AA Ammo with Long-Pointed Proj which was filled with 900g of TNT; was propelled by 2330g of No 16 cylindrical proplnt; used in Type 99 AA Gun (pp 342-43)

9-cm (90-mm) HE Ammo with Proj filled with 590g of crude TNT; used in an antiquated weapon classified as mortar; no info about proplnt used (p 343)

9-cm (90-mm) HE Ammo with Semisteel Proj which is filled with 650g of TNT; used in the same type of weapon as above; no info about proplnt used (pp 343-44)

Army 10-cm (105-mm) Ammunition

There were three 105-mm Howitzers and four 105-mm Guns, which are designated 10-cm by the Japanese. The projs were in most cases interchangeable. All weapons used semifixed ammo except the Type 14-Year AA Gun which used fixed ammo (p 344)

Following list (extracted from p 346) gives types and weights of propellant charges used in 105-mm Weapons:

Type 14-Year Howitzer - 430g in 3 increments of Mk 1 square grain or Mk 3 strip

Type 91 Howitzer - 1135g in 4 increments of Mk 2 square grain

Type 14-Year Improved Howitzer - 692g in 3 increments of Mk 2 square grain

Type 92 Gun - 4000g in 2 increments of Mark 3 strip

Type 14-Year Gun - 2535g in 2 increments of Mark 3 strip

Type 38 Gun - 1740g in 1 increment of Mk 2 strip

Type 14-Year AA Gun - 3075g in 1 increment of Mk 3 strip

Illustrations for cartridge cases used in the above weapons are on pp 347 to 350 and following are the projectiles used in 105-mm weapons:

Type 91 10-cm (105-mm) HE Proj is filled with 2300g of cast TNT; used in Type 91 How and Types 38, 92 & 14-Year Field Guns (p 351)

Type 91 10-cm (105-mm) HE, Long-Pointed Nose Proj was filled with cast TNT and "White Composition" of AN, RDX & GuN; used in Type 91 How, Types 38, 92 & 14-Year Field Guns and 14-Year AA Gun (with fixed Ammo) (pp 352-53)

12-cm (120-mm) Shrapnel Ammo with Proj contg BkPdr as ejecting chge and 539 lead balls packed in a rosin matrix. The proplnt was in two increments each encased in a silk bag with a small igniter chge sewed to the bottom of each; the 1st increment was NC in 5/16" square flakes, while the 2nd was NC in 1/16" square flakes; used in Type 38 How (pp 353-54)

12-cm (120-mm) AP-HE Ammo with Proj filled with PA; used the same proplnt and in the same weapon as for shrapnel ammo (pp 354-55)

15-cm (150-mm) Army Ammunition

There were three 150-mm Howitzers and four 150-mm Guns, which varied greatly in design from a very short-range How to long-range Field Guns. The projs were not as interchangeable as in 75-mm & 105-mm weapons. Usually there was one type of proj for use in Hows and another type for the Guns. All the weapons used semifixed ammo with the exception of Type 88 Gun which used a bag charge

Following list (extracted from p 357) gives types and weights of proplnt chges used in 150-mm Weapons:

Type 4-Year How - 2260g in 5 increments of Mk 2 square grain

Type 38 How - 825g in 2 increments of Mk 1 square grains

Type 96 How - 2930g in 5 increments of Mk 2 square grains

Type 45 Gun
Type 7-Year Gun } 16650g in 3 increments
Type 90 Gun } of Mk 5 strip

Type 89 Gun - 9700g in 2 increments of Mk 4 strip

Illustrations of cartridge cases used 150-mm wea-

pons are given on pp 358–61 and the following projectiles used in these weapons:

Type 92 15-cm (150-mm) HE Proj was filled with Angayaku (qv); used in Type 4-Year, Type 96 & Type 38 Hows (p 362)

Type 93 15-cm (150-mm) HE Proj was filled with cast TNT; used in Type 89, Type 45, Type 7-Year and Type 90 Guns (p 363)

Type 92 15-cm (150-mm) HE, Long-Pointed Proj was filled with cast TNT; used in Type 4-Year, Type 96 & Type 38 Hows (p 364)

Type 93 15-cm (150-mm) HE, Long-Pointed Proj was filled with cast TNT; used in Type 89, Type 45, Type 7-Year & Type 90 Guns (p 365)

Type 95 15-cm (150-mm) AP-HE Proj was filled with two preformed blocks of high grade TNT; used in Type 4-Year, Type 38 & Type 96 Hows and in Type 45, Type 7-Year, Type 90 & Type 89 (bag chge) Guns (p 366)

15-cm (150-mm) AP-HE Proj was filled with PA in two preformed, paper-wrapped bags; used in the same guns and Hows as above (p 367)

Type 13 15-cm (150-mm) Smoke (WP) Proj contd PA as bursting chge and WP cast in a brass cylinder which, surrounded by wax, was fitted below PA chge; used in Type 4-Year, Type 96 & Type 38 Hows (pp 367–68)

30-cm (305-mm) AP-HE Proj; no data for its filling (p 369)

30-cm (305-mm) AP-HE Proj; no data for its filling (p 370)

Army Rockets (Ref 3, pp 371–72) – See under **ROCKETS**

Army Mortars (Ref 3, pp 372–90) – See under **MORTARS**

Army Projectile Fuzes (Ref 3, pp 391–426) – See under **FUZES**

Ammunition, Navy (*Danyaku Kaigun*)

Accdg to Ref 1, p 170, **Japanese Navy Ammunition** of WWII was divided into the following groups:

- a) Small Arms Ammunition – items caliber 7.7-mm, 7.9-mm, 13-mm and 13.2-mm
- b) Aircraft Cannon Ammunition – items caliber 20-mm and 30-mm
- c) Antiaircraft “Automatic Weapons” Ammunition – items caliber 25-mm and 40-mm
- d) Large Caliber Ammunition – items of caliber 5-cm (50-mm) and over

Under the title “Japanese Ammunition—Explanatory Notes”, TM 9-1985-5 (1953)

(Ref 3, p IV), the following information is given:

The *Japanese Navy Terminology* of WWII for projectiles was highly irregular and cumbersome. Complete and accurate identification of proj required identification of the gun, descriptive nomenclature of the proj, and mark (or type) and modification number. For this reason an arbitrary system of nomenclature is used in TM 9-1985-5 (Ref 3). All Navy projs with a relatively heavy HE charge (including light AP types) are designated *TSUJODAN*, which may be translated either “Ordinary Projectile” or “Common Projectile”. In TM 9-1985-5, the term “Common” is reserved for light penetrating type of projectile (solid nose, base fuzed), while for projs having point-detonating fuzes, the US designation HE is used

Color system of marking projectiles for all sizes over 40-mm is explained on pp 427–31 of Ref 3, and projs of 40-mm and below on pp 432–33

The following Items of *Japanese Navy Ammunition* are described, including the illustrations, in TM 9-1985-5 (1953) (Ref 3, pages indicated under each Item):

7.7-mm Aircraft Machine Gun Ammunition with Ball AP, Incend, Tracer & HE Projectiles; no data for proplnt; used in Type 92 & Type 97 ACMG’s and in Type 92 AAMG (pp 434–35)
13-mm ACMG Ammunition with Tracer, HE (PETN)T and Incend (WP) Projs; no data for proplnt; used in Type 2 ACMG (pp 436–37)
13.2-mm AC and AAMG Ammo with Tracer, AP & HE(PETN) Incend (WP) Projs; no data for proplnt; used in Type 3 ACMG & Type 93 AAMG (pp 438-39)

Naval 20-mm Ammunition was divided into the following:

Type 99 20-mm Ammo (p 440) existed as Mk I and Mk II and was copied from the Swiss Oerlikon design. The proplnt consisted of graphited single-base, single-perforated cylindrical grains, 13.6g for Mk I and 21.4g for Mk II. Both Mk’s used the same types of projectiles, which were as follows:
20-mm HE Proj contd as filling 50/50–Pentolite (p 441)
20-mm HEIncend Proj contd as filling TNT and WP (p 442)

20-mm HETracer Proj contd Pentolite and tracer compn (p 443)

20-mm HET, Self-Destroying Proj contd Pentolite and Tracer compn. The proj was similar to the HET type except for its self-destroying feature. This was accomplished by ignition of BkPdr train leading from the tracer thru the hole drilled thru the septum of the proj and HE filling to the base of the gaine (p 444)

20-mm APIncend Proj contd Incend consisting of NC 77.5, Na nitrate 11.3 & Al pdr 11.2% which was loaded at the base. Upon impact the rear end of proj ruptured and the heat generated ignited the Incend compn. There was no fuze (p 444)

20-mm Tracer Proj was loaded with Tracer compn; the proj was called "bag buster" because it was usually the first round to be fired to break the muzzle cover of the gun (p 445)

20-mm Practice Proj contd no filling (p 445)

25-mm Naval Ammunition

The only 25-mm Gun used by the Japanese was Type 96 Model 2 AA-A/Tk Gun. It was multiple-barreled, air-cooled, magazine-fed, automatic weapon. Used different projectiles, but the same propellant which consisted of 120g of single-perforated graphited cylindrical grains of NC (p 446)

The following 25-mm Projectiles were used:

25-mm HE Proj contd 66/34-TNT/Al as std filling or cast TNT or Tetryl as alternates (p 447)

25-mm HEIncend Proj was filled with TNT/Al and WP (p 447)

25-mm HETracer Proj was filled with TNT/Al pellets and Tracer element. As alternate HE pressed or cast Tetryl was used (p 448)

25-mm HET (Self-Destroying) Proj contd TNT/Al pellets with BkPdr core in the lower pellet (p 448)

25-mm APT Proj contd 8.64g Tracer compn (Na nitrate, Mg & Ba peroxide) and 3.52g inert material (dry clay) (p 449)

30-mm Naval Ammunition

Two 30-mm Aircraft Cannons, the Type 2 and Type 5 were used during WWII. They were of Swiss (Oerlikon Co) design. Same proplnt was used in ammo of these guns. It consisted of graphited, single-perforated cylindrical grains of NC. The projectiles used were as follows:

30-mm Type 5 HE Proj was filled with cast Pentolite (p 451)

30-mm Type 2 & Type 5 HEIncend Projs contd 3.56g of Pentolite and 19.94g of WP (p 452)

30-mm Type 5 HETracer Proj contd in upper cavity Pentolite, while Tracer was in lower cavity (p 453)

30-mm Type 5 Tracer Proj contd nothing but Tracer (p 454)

30-mm Practice Proj contd no filling; was used as the first round to clear the gun bore (p 455)

40-mm Naval Ammunition was used in 40-mm Navy's Vickers-Armstrong Guns. Its proplnt consisted of 95.9g cylindrical length of smokeless pdr (p 455) and the following projectiles were used:

40-mm AP Proj contd 23g of cast TNT (p 456)

40-mm HE AA Proj contd 70g of cast TNT (p 457)

40-mm Tracer Proj contd nothing but Tracer compn (p 458)

5-cm (47-mm) Complete Round and Common Projectile. Its proplnt consisted of 67g unperforated, cylindrical, amber-colored sticks of double-base proplnt (5C2 Type 5-Year) enclosed in a compartmented bag of heavy brownish silk, placed in brass or steel cartridge. Its proj was 50g of loose granular BkPdr. Used in Short 5-cm Gun, mounted on wooden-spoked wheels as a field piece (pp 458-59)

8-cm (76.2-mm) (3-inch) Ammunition for use in various 8-cm/40 Guns included:

8-cm (76.2-mm) Complete Round (Semifixed) used 900g of 203C (Type 89) proplnt which consisted of unperforated 1/16-1/32 by 12.75 inches cylindrical sticks of double-base pdr enclosed in heavy paper and placed in brass cartridge (p 460); used one of the following projectiles:

8-cm (Ordinary Mk 2 Mod 2) HE Proj contd 0.71 lb of Shimose (cast PA) in single block sealed in a waxed paper (p 461)

8-cm Shrapnel Proj contd BkPdr as ejecting chge and shrapnel balls (p 462)

8-cm (Ordinary Mk 3 Mod 1) HE Proj contd 0.9 lb of Shimose (cast PA) (p 464)

8-cm AP Type 1 Special Common Proj contd 0.41 lb Type 91 Expl (Trinitroanisole) (p 465)

8-cm Time Practice Proj filled with either smoke compd or spotting dye (p 466)

10-cm (100-mm) (3.9-inch) Complete Round (Fixed) contd 12.7 lb of double-base proplnt

(Type 91 Mk 2) in the form of flat strips (pp 467-68). It was used with:

10-cm (100-mm) HE Proj which contd 3.13 lb of Type 92 Expl (cast TNT). Used in Type 98 10-cm/65 & 10-cm/50 Dual Purpose Guns (p 468)

12-cm (120-mm) (4.7-inch) Complete Round (Fixed) contd 1.1 lb Type 89 Proplnt consisting of unperforated cylindrical stick 1/32 by 6-7 inches of double-base pdr. Used in Short 12-cm Gun, 12 Calibers Long (p 469). Its projectile was: 12-cm/Short HE Proj contd 5.5 lb of Type 91 Expl (Trinitroanisole) (p 470)

12-cm (120-mm) (4.7-inch) Complete Round (Semifixed) contd in brass cartridge 11.88 lb of Type 13 Propellant consisting of unperforated cylindrical sticks of double-base pdr. Used in Type 11-Year 12-cm/45 Gun (Low Angle) with the following projs:

12-cm HE (Ordinary Mk 3) Proj contd 3.61 lb of cast PA (Shimose) (pp 472-73)

12-cm HE (Ordinary Mk 3 Mod 1) Proj contd 3.61 lb of Shimose (p 474)

12-cm HE (Ordinary Mk 4) Proj contd Shimose (p 475)

12-cm Common Projectile contd Shimose (p 476)

12-cm Illuminating Proj contd 0.5 oz of BkPdr as expelling chge and illuminant consisting of Ba nitrate 35.6, K nitrate 10.4, Mg 38.0, wax 13.9, carbon 0.8 & sulfur 1.3%. Compn of first fire compd was: K nitrate 63.2, wax 5.5, glass 6.1 & carbon 13.1%. Illuminant was located in 10 cardboard cylinders arranged in two layers of 5 cylinders, each contg 5.4 oz of illuminant.

The proj was used in Type 11-Year and Type 3-Year 12-cm/45 Guns (pp 477-78)

12-cm (120-mm) (4.7-inch) Complete Round (Fixed) contd in brass cartridge 12.0 lb of Type 13 double-base proplnt in the form of cylindrical sticks. Used in Type 10-Year 12-cm/45 Dual Purpose Gun with the following projs:

12-cm HE (Ordinary Mod 1) Proj contd 3.96 lb Type 91 Expl (pp 481-82)

12-cm HE (Ordinary Mod 2) Proj contd 3.46 lb of Shimose (p 482)

12-cm Incendiary Shrapnel contd 1.19 lb of Shimose and Incendiary charge consisting of WP & 48 steel pellets, total wt 8.55 lbs (pp 482-83)

12.7-cm (127-mm) (5-inch) Complete Round (Fixed) contd in brass cartridge 8.87 lb of Type

13 Double-Base Propellant consisting of graphited unperforated cylindrical sticks 0.079 by 15.75 inches packed in a compartmented bag of heavy silk. Used in Type 88 & Type 89 12.7-cm/40 Dual Purpose Guns with the following projectiles: 12.7-cm HE Proj was filled with 3.94 lb of Shimose (p 485)

12.7-cm Incendiary Shrapnel (Type 3 Ordinary) Proj contd 162g Shimose, 2.3g Tetryl, 0.13g LA, 35g BkPdr and Incendiary charge, which consisted of 43 steel pellets filled with the following compn: Mg pdr 54, Ba dioxide 26, rubber 15, Fe oxide 1.5 & sulfur 3% (adds to 99.5%) (p 486)

14-cm (140-mm) (5.5-inch) Propellant and Powder Tanks.

Under the term "powder tanks" sealed water-proof cylinders were used for storing propellant charges. Two types were recovered by Americans: one was a heavy tank (26.4 lbs) made of cast steel and bronze; the other was of sheet steel and Al (15.4 lbs). Both tanks were well lacquered inside and had the same internal dimensions - 6.2 by 33.4 inches

Propellant chge of 14-cm Bag Ammo consisted of 24.51 lbs of double-base proplnt 37C which consisted of graphited unperforated cylindrical sticks 0.15 by 28 inches, enclosed in a heavy silk bag. Used in 3-Year 40-cm/50 Gun (Low Angle) with the following projectiles:

14-cm HE Proj contd 7.9 lb Shimose (p 489)

14-cm HE (Type 0, Ordinary) Proj contd 6.60 lb Shimose (p 490)

14-cm (Ordinary Mk 1) Common Proj contd 5.94 lb Shimose (p 491)

14-cm (Ordinary Mod 1) Common Capped Proj contd 4.80 lb Shimose (p 492)

14-cm Illuminating Proj contd: primary ejection chge (100g BkPdr), secondary ejection chge (41g BkPdr); initiating pellet, relay train and delay were BkPdr; ignition compd for the illuminant (mixt of K nitrate, Fe oxide, Al, S & wax); illuminant (mixt of Ba nitrate, Mg & wax). Total weight of filling 31 lbs (p 493)

14-cm Smoke Proj was filled presumably with WP (p 494)

14-cm (140-mm) (5.5-inch) Cartridge Case (Semifixed) was of brass and contd 6860g of Type 13 double-base proplnt consisting of graphited unperforated cylindrical sticks 1/8 by 19% inches enclosed in a heavy silk bag. No

projs used with this case are listed (p 495)
15-cm (152-mm) (6-inch) Complete Round (Semifixed) used 18.94 lb 37DC Double-Base Propnt which consisted of graphited unperforated cylindrical sticks 1/8 by 26 inches enclosed in heavy silk bag packed in a brass cartridge. Used in Type 41 (Meiji) 15-cm/40 Gun (Low Angle) with the following projectiles:

15-cm Common (Ordinary Mod 1) Proj contd Shimose (p 497)

15-cm HE (Ordinary Type 0) Proj contd 6.8 lb Shimose (p 498)

15-cm Common (Ordinary Mk 4) Proj contd 5.9 lb Shimose (p 499)

15-cm Incendiary Shrapnel Proj – no data for filling (p 500)

15.5-cm (155-mm) (6.1-inch) Ammunition was used in 15.5-cm Gun (Bag). No data for propnt used but the following projectiles are listed:

15.5-cm HE (Ordinary Type 0) Proj contd 7.5 lb Shimose (p 502)

15.5-cm AP (Type 91) Proj contd 6.84 lb Trinitroanisole (p 503)

15.5-cm Illuminating Proj was filled with the same substance as 14-cm Illuminating Proj (p 504)

20-cm/Short (202-mm) (8-inch) Complete Round (Semifixed) was used in 20-cm Short Gun. Its propnt was double-base 10C3 (Type 89) consisting of unperforated cylindrical sticks 1/32 by 8½–9 inches, enclosed in two compartmented heavy silk bags packed in brass cartridge. The inner bag contd 2.1 lb of propnt, while the outer bag had 2.3 lb. The following projs were used:

20-cm/Short HE (Ordinary Mk 1) Proj contd 28.50 lbs Trinitroanisole in three cast blocks (p 506)

20-cm AP, Type 91 Proj contd 17.38 lb TNAns in a preformed block (p 507)

20-cm HE (Ordinary Type 0) Proj contd 21.34 lb of TNAns (p 508)

36-cm (365-mm) (14-inch) AP Proj used in 36-cm/45 Gun (Bag); probable filling of proj – TNAns (p 510)

40-cm (406-mm) (16-inch) Mk 5 AP Proj was used in 40-cm/45 Gun (Bag); probable filling – Trinitroanisole (p 511)

Note: Under Navy Ammunition are also described Rockets (Ref 3, pp 512–14); Mortars (pp 515–17) and Projectile Fuzes (pp 514–43),

but they are described here separately under corresponding letters in alphabetical order
Refs for AMMUNITION:

1) Anon, "Handbook of Japanese Explosive Ordnance", **OPNAV 30-3M** (1945), pp 123–57 (Army Ammo) & 170–91 (Navy Ammo)

2) Anon, "Japanese Explosive Ordnance", **TM 9-1985-5** (1953) 4) W.H. Tatum IV & E.J. Hoffschmidt, Edts, "Japanese Combat Weapons of World War II", WE Inc, Old Greenwich, Conn, Vol 2 (1968)

Amphibian (Water) Mines. See under MINES

Anbenyaku or Shōbenyaku. HE mixture consisting of AN 55 & Dinitrobenzene 45% used during WWII as bursting chge of some projectiles. The name Shōbenyaku was used at Nanman Arsenal, Manchuria. An exptl mixt by the same name consisted of AN, TNBz & Tetryl

A blasting expl, also called Anbenyaku, consisting of AN 71.7, NG 8.0, Collod Cotton 0.3 and powdered seaweed 20% was proposed in 1948 by T. Watanabe, JapanP 176113 (1948) & CA 45, 4930 (1951) (Ref 5, p 361)

Angayaku. Several HE compns were known. One of them listed in Ref 1, p 27 consisted of AN 75 & RDX 25%. It was cast in TNT surround for filling bombs. The compn listed in Ref 6, p 8-3: RDX 85 & wax 15% was used in AP Projectiles while compn: RDX 41, PETN 50 & wax 8% was used in Machinegun Bullets

In addn to these, the following compns are listed in Ref 5, p 362: a) AN 84 & RDX 16%; b) AN 51, RDX 15 & GuN (Guanidine Nitrate) 34% and c) AN 48, RDX 20 & GuN 32%

All of the above compns were white in color, nontoxic and comparable in performance to Amatols. It was claimed that compns contg GuN had low coefficients of shrinkage and, therefore, could be poured in large casts in a single pour

Another Angayaku compn considered to be similar to Brit & US Torpex consisted of AN 43.2, GuN 28.8, RDX 8.0 & Al powder 20% was manufd at the Sankanoichi Factory of the Tokyo Army Arsenal No 2. It was used to a limited extent in various types of underwater expls (Ref 5, pp 361–62)

As an example of use of Angayaku as a

filler may be cited Type 94 7-cm (75-mm)
HE Proj described and illustrated in Ref 3, p 321

Armored Cars. See under Combat Vehicles

Armor-Piercing High-Explosive (AP-HE) Projectile. Hakoryudan Tekkōdan

Armor-Piercing (AP) Projectile. Hakodan or Tekkōdan

Arsenals (Kōshō or Zōneisho) and Powder Factories (Kayaku seizōsho)

The following Arsenals are listed in Ref 1, p 6: Tokyo, Osaka, Kure, Toyokawa, Yokōsuka, Maizuro and Sasebo. Tokyo and Osaka were the Army Arsenals, while the other five were the Navy Arsenals

The following Arsenals are listed in the book of Tatum & Hoffschmidt, listed here as Ref 7, p 38: Kokura, Tokyo, Nagoya, Heijo, Osaka, Chioda and South Arsenal. In the same book the Tokyo Explosives Plant is listed

ARTILLERY (Hōhei) AND ITS WEAPONS (Hō)

In the book of Tatum and Hoffschmidt (Ref 7), Section 3, pp 80–116, the following weapons are described and illustrated:

37-mm Infantry Gun, Mod 11 (1922) (pp 80–1)

37-mm Gun, Mod 94 (1934) (pp 84–5)

47-mm Antitank Gun, Mod 1 (1941) (pp 84–5)

70-mm Battalion Howitzer, Mod 92 (1932) (pp 86–7)

75-mm Field Gun, Mod 38 (1905) (Improved) (pp 88–9)

75-mm Regimental Gun, Mod 41 (1908) (pp 90–1)

75-mm Antiaircraft Gun, Mod 88 (1928) (p 92)

75-mm Mobile Field AA Gun, Mod 88 (1928) (p 93)

Note: On p 94 are given illustrations of the following Japanese Antiaircraft Cannons:

75-mm Heavy AA Cannon, M88 (1928) – the Standard Army; 76-mm AA Cannon, M3 (1914);

105-mm Army AA Cannon M14 (1925) and

127-mm Twin Mount, Dual-Purpose Cannon, M98 (1929)

Table on p 95 lists "Japanese 75-mm Artillery Ammunition". This includes Models of Projectiles, Their Bursting Charges, Standard Fuzes and Models of Guns:

75-mm Field Gun, Mod 90 (1930) (p 96)

75-mm Mountain (Pack) Gun, Mod 94 (1934) (pp 97–8)

75-mm Field Gun, Mod 95 (1935) (pp 99–100)

8-cm (7.62) High Angle Gun, Type 3 (p 101)

88-mm Antiaircraft Gun, Type 99 (Year ?) (p 104)

105-mm Howitzer, Mod 91 (1931) (pp 103–04)

105-mm Gun, Mod 92 (1932) (pp 105–06)

120-mm, 45 Calibers, Naval Dual Purpose Gun, Type 10 (p 107)

120-mm, 45 Calibers, 11-Year Type Gun (p 108)

140-mm Seacoast Gun, Type 3 (Year ?) (p 109)

Note: Table on p 110 lists "Characteristics of Principal Japanese Weapons":

150-mm Howitzer, Mod 4 (1915) (pp 111–12)

150-mm Howitzer, Mod 96 (1936) (pp 113–14)

300-mm Short Howitzer, Type 7 (Year ?) (p 115)

105-mm Field Gun, Type 14 (Year ?) (p 115a)

(See also Mortar and Rocket)

Artillery Ammunition. See under AMMUNITION

Aruminyūmu. Aluminum. It was used in powdered form in many Japanese Navy comps, such as Otsu B, Type 2, Type 4 & Type 92, listed in Ref 1, pp 32–33. It was also contd in one of the Army expls – Angayaku (qv)

B4 (Incendiary) or Type 2 Navy Explosive.

A light-gray castable mixture of Trinitroanisole 60 to 70 & Al 40 to 30%. The props of the 60/40 mixture were: density 1.90; Brisance by Cu cylinder crusher test 82% (PA=100%); Expln Temp 300°; Impact Sensitivity with 5kg wt 17cm maximum with no explns; Friction Sensitivity with 60kg pressure – no explns; and Power by Ballistic Mortar 64% of PA. It was used in Submarine Gun Incendiary Shells (Ref 5, p 362)

"Baka" Piloted Rocket Bomb. See under BOMBS and in Ref 2, pp 116–18

Bakkan Blasting Cap

Bakubō. Detonator

Bakuchiku. Squib

Bakudan. See BOMB

Bakufun. Detonating Explosive or Exploding Powder. A light-gray to tan pdr consisting of MF (Mercuric Fulminate) 28.8, K chlorate 37.7, Antimony trisulfide 31.5 & abrasive 2%. Accdg to documents, Mks I & III are used in ammunition primers while Mk 2 is used in fuze primers (Ref 1, p 25 & Ref 5, pp 362-63). See also Raibun

Bakuhaki. Exploder; Blasting Machine

Bakuhatsu. Explosion, Blast or Detonation

Bakuhatsu kōryoku. Blast Effect

Bakuhatsu sei. Blasting Gelatin

Bakuhayaku. Detonating Explosive; Brisant Explosive

Bakuhuyō bakudan. General Purpose Bombs; Demolition Bomb

Bakurai. Depth Charge

Bakurai tōshahō. Mine Thrower; Y-Gun

Bakuretsu jūdan. Explosive Bullet

Bakuyaku. Explosive Charge; Powder Charge

Bakuyakyō. Bangalore Torpedo

Balloons, Paper. Ingenious paper balloons were launched in 1944 against the West Coast of the US and Canada. This is described in Vol 2 of Encycl on p B11-L, under "Balloons and Airships and Their Application in War"

Bangalore Torpedo. Bakuyakuto or Hakaitō. See under Demolition Tubes

Barisutaito. Ballistite

Biransei gasu. Blister Gas

Black Powder. Kokushokuyaku (Black Color Explosive) or *Yuenyaku* (Nonsmokeless Powder); **Gunpowder** — *Kayaku*. Black, loose-powdery material consisting of K nitrate, sulfur & charcoal. It was used during WWII for the follow-

ing items: a) Army 20-mm Ammo as a temporary measure; b) Army ejector charges for 70-mm Barrage Mortar, Shrapnel Shells & Pyrotechnics; c) Army Delays & Relays in Bomb & Projectile Fuzes; d) Army Delays and Igniters in Pyrotechnics; e) Navy ejector charges for Illuminating Shells & Pyrotechnics; f) Navy Delays & Relays in Bomb & Projectile Fuzes and g) Navy Delays & Igniters for Pyrotechnics (Ref 1, pp 27, 30 & 33)

Blast. Bakuhatsu

Blasting Cap. Bakkan

Bōgyō. Sabotage

Bōgyo. Defense

Bōgyo jirai. Antitank Mine

Bokūyō kaki. Antiaircraft Weapon

BOMBS (Bakudan) (Excluding Flares and Rocket Bombs)

Introduction

Accdg to TM 9-1985-4 (1953) (Ref 2, p 1), the Japanese Army (Rikugun) and Navy (Kaigun) had during WWII separate Air Forces (Kūgun), each of which employed its own distinct bombs and fuzes (Shinkan). For the most part the Army and Navy bombs and fuzes cannot be used interchangeably. Special adapters have been developed, however, which allowed some flexibility of this rule

Until the reign of the present Emperor (Showa era, which started in 1926), items were designated by the year era. Now, however, the year of the Japanese Empire—2600, which corresponds to our 1940, may be used. For items introduced up to the year 2600, the last two numbers are used in the designation. Thus, Type 99 means the item was adopted in 2599 or our 1939. The year 2600 may be represented as Type 100 or Type 0, and the years 2601, 2602, etc as Types 1, 2, etc

Exptl ordnance items are assigned the type numbers indicating the year of Showa era during which the experiment was standardized

Ordnance items standardized in the eras preceding the Showa era; namely, Taisho (1912—

1926) and Meiji (1867–1912) are designated by the era and the year. Type II (Taisho) = 1922 and Type 41 (Meiji) = 1908

Some items developed for a special purpose were designated by a Mark number. The term Model indicates a change in basic design, while the term Modification represents minor changes in design or a change in explosive

Abbreviations are the same as indicated under AMMUNITION

Bombs, Army (Bakudan Rikugun)

The following Army Bombs are listed in

Ref 2 on pages indicated under items:

Type 92 15-kg HE contd cast PA or TNT (pp 4–5);

Type 99 30-kg HE contd 48/52–RDX/TNT (p 5);

Type 94 50-kg HE, Type 3 100-kg HE, Type 94

Modified HE, Type 1 50-kg HE, Type 1 100-kg

HE, Type 1 250-kg, Type 92 250-kg and Type

92 500-kg HE Bombs were filled with cast PA

(pp 6–9);

Type 3 100-kg and Type 3 250-kg Skipping

Bombs contd paper-wrapped cast PA blocks

sealed with TNT (pp 10–11);

Type 4 100-kg, 250-kg & 500-kg Antishipping

Bomb contd paper-wrapped cast PA blocks

sealed with TNT (pp 12–13);

1-kg and 5-kg Thermite Incendiary Bombs

contd Thermite as main chge and first fire

chge (pp 14–16);

Type 97 12-kg Thermite consisted of a thin

steel body contd two BkPdr chges and three

Thermite filled Mg fire pots (pp 16–18);

Type 97 50-kg and Type 100-kg Incendiary

Bombs consisted of thin-steel body filled with

400-450 rubber bags impregnated with soln of

phosphorus in CS₂. The HE chge in the nose

and central burster tube was PA (pp 18–20);

Type 100 50-kg Smoke Bomb consisted of

thin-steel body filled with FS smoke compn

(chlorosulfonic acid 41, sulfur trioxide 54 &

sulfuric acid 5%). The HE chge in the nose

and in the burster was PA (p 21);

Type 92 Gas Bomb contd 50/50–Lewisite/

Mustard Gas (p 22);

Type 97 15-kg Concrete Bomb was a light sheet

steel cylinder with central exploder tube filled

with cast PA which was surrounded by steel

pellets set in concrete (p 26);

Type 94 10-kg Substitute Bomb consisted of a

thick concrete case surrounding a steel central

tube burster filled with loose BkPdr. The tube

was surrounded by steel pellets set in concrete (p 27);

Type 1 30-kg Substitute Bomb consisted of a

light sheet steel cylinder surrounding a central

steel burster tube contg in forward part BkPdr

chge and after part HE chge. The space betw

the tube and outer casing was filled with steel

pellets set in concrete (pp 27–28);

Type 95 4-kg Practice Bomb housed an ampoule

contg a smoke compn (p 29)

Cluster Bombs: Type 2 1/3-kg, Type 3 1/2-kg

and Type 2 1/2-kg contg TNT 58–60 & RDX

42–40% fillers (pp 29–32). Containers for

these bombs are described on pp 33–36;

1-kg Aircraft Missile consisted of a spherical

compressed paper container from which a 3-

inch high tubular neck of compressed cardboard

projected. A wooden plug at the base of this

neck housed a friction pull igniter. A central

burster chge consisted of granular BkPdr in a

silk bag. Surrounding this were 32 cylindrical

sheet-metal pellets contg a LE (Low Explosive)

chge of K nitrate 55.7, sulfur 16.7, Al 14.6 &

antimony sulfide 13.0%. Each pellet had a

1/2-inch safety fuse which was in contact with

burster chge. For its operation the cord of the

igniter was pulled and the missile was thrown

from the plane. After a short delay the BkPdr

burster chge exploded rupturing the paper body,

scattering the expl pellets and simultaneously

igniting the fuse of the pellets. After a short

delay the pellets were detonated. This missile

was used in air-to-air bombing (pp 36–7 & Fig 31);

50-kg & 100-kg Pamphlet Containers consisted

of cardboard case contg a small burster chge and

paper pamphlets (p 38);

Miscellaneous Army Bombs – Illustrations with-

out description of several bombs are given on pp

39–40

A shorter description, with illustrations, of

Japanese Army Bombs is given in Ref 1, pp

66–80

Bombs, Navy (Bakudan Kaigun)

Introduction

Accdg to Ref 2, p 41, Navy bombs were di-

vided into the following classes: "Land" bombs

specially designed for use against land targets;

"Ordinary" were designed for use against ships.

They included both GP (General Purpose) and

SAP (Semi-Armor-Piercing);

"Special" are designed for special purposes and

each class is indicated by a mark number; "Smoke" were used for concealment purposes; "Practice" were used for practice bombing; "Target-marker bombs were used as target-marking beacons; "Training" bombs were used for training in handling; "Dummy" bombs were used for training and practice bombing .

Individual Navy bombs in these main general classes were given the Type number (such as Type 97) which disclosed the year that the bomb was adopted for service use. In the "land" and "ordinary" classes, the 1st bomb of a given wt class was not assigned a Type number but was merely indicated by the wt number. Subsequent designs of the same wt were assigned Type numbers. Thus there was a No 6 land bomb and a Type 97 No 6 bomb. The No indicated the wt in units of tens of kg. Thus a No 6 bomb weighed 60-kg, a No 25 weighed 250-kg, etc. For "special" bomb the Mk number was given. The term Model usually meant a different design of the bomb in the same general class, while Modification meant a minor change in the design or filling

Type 97 No 6 Land Bomb had a sheet steel body filled with PA or Type 98 Explosive (p 45);

Type 2 No 6 Land Bomb had sheet steel body filled with five 7-kg HE bombs and contd central burster tube filled with HE (pp 46-7); No 25 Land Bomb and Type 96 No 25 Land Bomb had steel body filled with PA or Type 98 Expl (pp 47-9);

No 80 Land Bomb had steel body filled with PA or Type 98 Expl (p 49);

Type 99 No 6 Ordinary Bomb had steel body filled with PA or Type 98 Expl (p 50);

Type 99 No 25, also No 80, Ordinary Bombs Model 1 were filled with Type 91 Expl (pp 50-1 & 53);

Type 2 No 50 Ordinary Bomb Model 1 was filled with Type 98 Expl (p 52);

No 3, No 6 & No 25 Ordinary Bombs Model 2 were filled with PA (pp 54-5);

No 50 Ordinary Bomb Model 2 was filled with Type 98 Expl (p 56);

No 6 Mk 1, Type 1 No 6 Mk 1 and Type 4 No 6 Mk 1 Bombs were filled with mustard gas thickened with methacrylate & polyvinyl alcohol (pp 56-7);

Type 4 No 6 Mk 1 Bomb was designed to be filled with mustard gas or with any suitable CWA (Chemical Warfare Agent) (p 58);

Type 99 No 6 Mk 2, Type 99 No 6 MK 2 Modification 1, Type 1 No 25 Mk 2 Model 1 and Type 1 No 25 Mk 2 Model 1 Modification 1 Bombs were filled with Type 98 Expl (pp 58-63);

Type 99 No 3 Mk 3 Bomb consisted of a sheet metal cylinder contg a canister with 168 WP-filled steel pellets. PA chges were in tail cone and central burster (pp 63-4);

Type 3 No 6 Mk 3 Model 1 Bomb contd three cylindrical steel canisters, each contg 87 WP-filled cylindrical steel pellets; each canister had central exploder filled with Type 98 Expl (pp 64-6);

Type 2 No 25 Mk 3 Model 1 Bomb contd an incendiary chge consisting of Ba nitrate 35.8, Al 13.6, Mg 10.3, Fe oxide & synthetic rubber shavings 13.1%; two igniter chges (Ba nitrate 75.2, Al 24.2 & oil 2%) were located in the nose piece and in the tail cone (pp 66-7);

Type 3 No 25 Mk 4 Modification 1 Bomb was of AP design and contd a small chge of Type 91 Expl used in all Navy AP ammunition (pp 68-9);

Type 99 No 80 Mk 5 Bomb was of forged steel and contd a large chge of Type 91 Expl (pp 69-70)

Type 2 No 8 Mk 5 and No 150 Mk 5 Bombs were of AP design and used small chges of Type 91 Expl (pp 70-1);

Type 98 No 7 Mk 6 Model 1 Bomb contd four Thermite-filled electron fire pots. A central channel filled with quick match ran thru the length of the bomb. A BkPdr chge was located in the circular recess of the nose piece (pp 71-72);

Type 98 No 7 Mk Model 2 Bomb contd a central Thermite core surrounded by a solidified kerosene, petrol, alcohol, soap mixture. A BkPdr burster chge was located in the nose. A copper tube contg quickmatch was located inside Thermite tube (pp 73-4);

Type 1 No 7 Mk 6 Model 3 Modification Bomb consisted of a sheet steel cylindrical body contg 182 cylindrical pellets arranged around a central cardboard tube contg gray igniter mixture (Ba nitrate 75, Al 24.5, oil 0.3 & moisture 0.2%). The pellets (which contd Ba nitrate 35, ferric oxide 28, Al 18 & synthetic rubber shavings

9%) were bound with a string to form rings (pp 74-5);

Type 3 No 25 Mk 8 Model 1 Bomb was of sheet steel contg Type 97 Expl (pp 76-7);

Type 2 No 6 Mk 21 Model 1 Bomb contd BkPdr igniter and 40 one-kg HE(?) hollow chge bombs, arranged vertically in two rows (pp 77-8);

1-kg Hollow Charge Bomb contd Type 98 Expl and Tetryl booster (pp 79-80);

Type 2 No 6 Mk 21 Model 2 Bomb contd 36 one-kg HE(?) bombs arranged vertically in three rows (pp 80-1);

1-kg Antipersonnel Bomb contd Type 97 Expl (pp 82-3);

Type 3 No 6 Mk 23 Model 1 Bomb was of sheet steel contg PA or Type 98 Expl (pp 83-4);

Type 4 No 25 Mk 29 Bomb was cylindrical in shape with a central burster chge of HE(?) surrounded by WP incendiary shrapnel (pp 87-8);

Type 5 No 25 Mk 33 Bomb was designed to detonate upon approach to the earth. It contd the "all-ways action electrical nose fuze" and "atmospheric tail fuze". The bomb contd HE(?) chge surrounded by steel pellets (pp 92-3);

Practice Bombs - three types are described on pp 93-7;

2-kg Window Bomb consisted of sheet metal cylinder filled with 250 paper strips coated on one side by metal foil which were placed around an inner vertical tube contg the delay element and smokeless pdr ejection chge. Empty space betw the strips was filled with iron pyrites. The bomb was thrown by hand from the plane's window (pp 115-16).

A less detailed description of bombs is given in Ref 1, pp 66-80 (Army) and 90-109 (Navy) *Refs for Bombs:* 1) OPNAV 30-3M (1945) 2) TM 9-1985-4 (1953)

Bomb Fuzes. See under FUZES

Booby Traps (Yūgekiteki jirai). See under Mines (Land) and Booby Traps

Booster Charge (Denkabakuyaku). See under Gaine

Breech. Hōbi

Breechloader. Kōsōhō

Brown Powder - *Kasshokuyaku* (Undercarbonized Black Powder). Known only from documents but was never recovered by US investigators. Use unknown (Ref 1, p 30)

Brown Powder (Navy). This name was assigned in Ref 1, p 32 to the mixture: Amm chlorate 51.5, Ba nitrate 34.5, TNN (Trinitronaphthalene) & oil 8.2 & wood pulp 5.0%. Substance dangerous to burn in large quantity. It was found as a booster in preparing bombs for demolition

Buki. Arm, Weapon

Bullet. Dangan

Bunri yakutō. Separate-loading Ammunition

Burst. Haretsu

Burster. Sakuyaku

Bursting Charge. Sakuyaku

Buryoku. Military Force

Caliber. Kōkei

Cannon. Taihō, Kahō, Kanōhō

Cap (explosive). Bakkan

Carbine. Kijū

Carlit. Accdg to a Pamphlet of "The Japan Carlit Co, Ltd", located before WWII at Chiyodaku, Tokyo, *Carlit* was invented in 1917 by O. Carlson and manufd in Japan since 1919. It was an Amm Perchlorate expl contg ferrosilicon & woodmeal. It was used in the same way and for the same purposes as Dynamites. Properties of Carlit are described in the Pamphlet

In Vol 2 of Encycl, p C68 is described a Japanese Army expl *Carlit* or *Karitto* consisting of Amm Perchlorate 66, Si carbide 16, woodpulp 12 & petroleum 6%. The same compn was given for *Karitto* in OPNAV 30-3M (1945), p 29, listed here as Ref 1. Its Navy name was *Type 88 Explosive* (qv) (See also under *Karitto*)

Carriage (Arty). Hōga

Cartridge (Fixed Ammo). Danyakuohō

Cartridge Bag. Yakunō

Cartridge Case. Yakkyō

Cast (Expl Filling). Chūten (bakuhatsumo)

Cast Iron HE Projectile. Chutetsu ryūdan

Cavity (in Projectile). Shinkō

Chakatsuyaku. 2,4,6-Trinitrotoluene (TNT), also called **Sanshōki toruōru** or **Type 92 Explosive (Navy)**, $H_3C.C_6H_2(NO_2)_3$; lt yel to buff expl, d (cryst) 1.65, mp 80.6° ; Brisance by Sand Test — 48.0g sand crushed; Expln Temp — decomp at 475° in 5 secs; Impact Sensitivity, Bur Mines, 2kg wt 100cm+; PicArsn App 14–15 inches; Power — 100% TNT, Rate of Deton 6900m/s at d 1.6. Used by the Japanese Navy straight in some 25 & 40mm Shells, while the Army used it in Grenades, Mines, Demolition Charges and a few Bombs

Also used in the following composite explosives: A(ko), Chanayaku, Chaoyaku, Chauyaku, Nigotanoyaku Mk 2, Otsu-B or Type A, Pentoriru, Seigata (Army) or Type 97H (Navy), Shoanyaku, Shōtoyaku, Tanoyaku, Type 92, Type 97H and others (Ref 1, p 26; Ref 5, p 363 & Ref 8, p 350)

Chakuhatsudan. Percussion Shell

Chakuhatsu ryūsandan. Percussion Shrapnel

Chakuhatsu shinkan. Percussion Fuze, Impact Fuze

Chanayaku. A yel castable composite expl consisting of TNT 70 & DNN (Dinitronaphthalene) 30%. Used for loading some Army Artillery Projs (Ref 1, p 26 & Ref 5, p 364)

Chaoyaku. A lt-yel mixture of PA (Picric Acid) 75 & TNT 25%, which melts below 120° and explodes at below 350° ; brisance and detonation velocity are lower than those for PA and it is less sensitive. Press-loaded (or rarely cast) in some Army Bombs (Ref 1, p 26 & Ref 5, p 364)

Chauyaku. A castable mixture of RDX (Cyclonite) 50 & TNT 50%, corresponding to Amer Cyclotol. Used for loading some Artillery Projectiles. Other RDX/TNT mixtures are listed under Nigotanoyaku Mk 2 (Ref 5, p 364)

Chikkaen (Army) or Chikka namari (Navy). Lead Azide (LA), $Pb(N_3)_2$, creamy white to buff or very light gray pdr; detonates w/o melting at ca 350° ; decompd by acetate soln. Most common initiator for detonators and fuzes, especially where a BkPdr relay is present (Ref 1, p 25 & Ref 5, p 364)

Chitai suru. Delay

Chūjō kayaku. Cordite

Chūkei. Relay

Chūkū no. Hollow

Chūtai kikan. Recoil Mechanism

Chūtai sōchi. Recoil-operated

Coal. Sekitan

Coast Artillery (Weapons). Kaiganhō

Combat. Sentō

Combat Ammunition. Shōkōri danyaku

Combat Vehicles (Sentō jidōsha) and Their Weapons (Heiki). In the book of Tatum & Hoffschmidt (Ref 7, Section 4, pp 117–135) are described and illustrated the following items:

Tankette, Mod 2592 (1932) (pp 116–17)

Tankette, Mod 2594 (1934) (p 118)

Tankette, Mod 2597 (1937) (p 119)

Light Tank, Mod 2593 (1933) (p 120)

Light Tank, Mod 2595 (1935) (p 121)

Medium Tank, Mod 2589A (1929) (p 122)

Medium Tank, Mod 2589B (1929) (p 123)

Medium Tank, Mod 2594 (1934) (pp 124–25)

Medium Tank, Mod 2597 (1937) (Special) (p 126)

Medium Tank, Mod 2597 (1937) (p 127)

Amphibious Tank (p 128)

150-mm Self-Propelled Howitzer (p 129)
 47-mm Tank Gun, Type 1 (1941) (p 130)
 5.7-cm Tank Gun, Mod 97 (p 131)
 Armored Car (Vickers-Crossley, M-25) (p 132)
 Armored Car, Mod 2592 (1932), Naval Type (p 133)
 Armored Car, Mod 2592 (1932), "Osaka" (p 134)
 Armored Car, Mod 2593 (1933), "Sumida" (p 135)
Note: There are also listed: motorcycle, motor-tricycle, scout car, locomotive truck, several trucks, several prime movers, armored car recovery vehicle and two tractors (pp 136-54)

Combat Weapons are described in the book of W.H. Tatum IV & E.J. Hoffschmidt, Editors, entitled: "Second World War COMBAT VEHICLES Japanese", Published by WE Inc, Old Greenwich, Connecticut, Vol 2 (1968), listed as Ref 7 at the end of this Section. Included among others are:

Infantry: Small Arms Weapons, Pistols, Rifles and Machine Guns (pp 39-78)

Artillery: Antitank, Antiaircraft, Light and Heavy Field Guns (pp 79-115a)

Combat Vehicles: Tanks, Self-Propelled Guns, etc (pp 116-54)

Miscellaneous Weapons: Rockets, Mortars, Mines, Grenades, Telescopes and Ammunition (pp 155-92)

Combination Fuze. Fukudo shinkan

Combustion. Nenshō

Combustion Chamber. Nenshōshitsu

Complete Round. Danyakutō (Fixed Ammo)

Component. Kōseibunshi

Cordite. Chūjō kayaku

Cyclonite or RDX. Shouyaku

Cyclotol (50/50-RDX/TNT). Chauyaku

Dagger. Tanken

Dainamaito. Dynamite
 NG (Nitroglycerol) contg composite expls from buff to brown color. Accdg to documents there were diatomaceous earth contg, NC (Nitro-

cellulose) contg - Gelatin Dynamites (See Geogel). "Faint Smoke" Gelatin Dynamite contd borax or salt. Nonfreezing Dynamites contd NGc (Nitroglycol) or Dinitroglycerol. Ammonium Nitrate Dynamites contd AN (such as Akatsuki). There is also Semigelatine Dynamite, such as Enoki No 2 Dynamite (Ref 1, p 29). See paper of K. Sassa & I. Ito in *Kōgyo-KayakuKyōkaishi* 32, No 6 (Nov-Dec 1971) translated by Mrs Geti Saad at the BurMines in 1972

(See also under Additional References at the end of this Section)

Danchaku. Impact (of Projectile)

Dandō. Trajectory

Dandōgaku. Ballistics

Dangan. Projectile, Shell, Bullet

Dantai. Body (of Projectile or Bomb)

Dantei. Base of Projectile

Dantei shinkan. Base Fuze; Tail Fuze

Dantō. Nose of Projectile or Bomb; Point of Projectile

Dantō bakkan. Point Detonating Fuze

Danyaku. Ammunition

Danyakutō. Cartridge; Complete Round

Danyoku. Fin of Bomb

Denkayaku. Booster Charge. See under Gaine

Denki bakkan. Electric Primer

Denki raikan. Electric Cap

Denki tenkagu. Electric Blasting Machine; Exploder

Deflagration. Totsunen; Bakunen

Delay. Chitai suru

Delayed-Action Bomb. Chidō bakudan

Delayed-Action Fuze; Delay Fuze. Chidō shinkan

Delayed-Action Mine. Chidō jirai

DEMOLITION CHARGES (Hakaiyaku) and EQUIPMENT (Sōgu)

Following information is given in Ref 1, pp 28–29 & 233–36 and in Ref 2, pp 30 & 252–55

Japanese equipment consisted of:

A. Safety Fuses and Safety Fuse Igniters.

Several types of fuses with rate of burning of 30, 32 and 45 seconds per foot were used (p 234). The Igniters were: Trigger Type (Fig 381 on p 233); Pull Type (Fig 382 on p 234) and Type 99 Demolition Tube Igniter (p 233)

B. Blasting Caps. Three types of non-electric and four types of electric caps were known (p 234)

C. Detonating Cord, Type 97, described on p 234, contd a core of PETN (Shoeyaku), surrounded by cotton, hemp and waterproof layers. Diameter 1/4 inch and Detonation Velocity 6000m/sec

D. Demolition Explosives consisted of the following:

a) *Plastic Explosive Koshitsu* (qv) (Army) consisted of RDX (Shouyaku) 80 & vegetable oil 20%, made into rolls 4 inches long, weighing 4 oz each. Issued for field use in three rolls packed in a paper package (Ref 1, pp 28 & 234)

b) *Prepared Charges.* Three main (standard) Army demolition blocks, 2x2x1-inch size were used: 1) PA (Shimose bakuyaku); 2) Haishokuyaku (qv) and 3) Nigotangyaku (Tanoyaku) (50/50–TNT/RDX) (pp 28–30 & 234 of Ref 1 and p 230 of Ref 2); 4) Combined Demolition Blocks – two, three or four TNT and PA blocks were provided with a hole to receive the detonator (p 235 of Ref 1); 5) Demolition Cans were rectangular made of zinc. Three sizes are described in Ref 1, p 234: 1-kg Can was filled with cast, wrapped PA; 5-kg Can was

filled with cast, wrapped PA; and 30-kg Can contd 30kg of PA charges, rounded or square
c) *Substitute Army Demolition Explosives.* The following are listed in Ref 1: Entoyaku (qv) (p 28), Ennayaku (qv) (p 28), Dainamaito (qv) (p 29), Shoanbakuyaku (qv) (p 29), Karito (qv) (p 29) and Ammonyaku (qv) (p 29)

E. Demolition Clocks. The following types are described and illustrated in Ref 2, pp 252–55:

- a) Twenty-Four Hour Demolition Clock (p 253; Fig 191, upper)
- b) Type 99 Long-Delay Demolition Clock (p 253; Fig 191, lower)
- c) Seven and One-Half Day Demolition Clock (p 255, no Fig)
- d) Type 92 Seven-Day Demolition Clock (p 255; Fig 192)

F. Demolition Block, shown in Fig 211, p 159 of Ref 1, consisted of a cast-iron cylinder (4½x6 inches or 4¾x4¾ inches) contg blocks of PA. The body was mounted on a stick 21 inches long. When the device was fired from an Army Mortar, two Pull Igniters in the charge ignited a delay train of 7 seconds

DEMOLITION TUBES. Under this title are described in Ref 1, pp 236–37 several demolition items in the form of tubes, such as:

a) *Bangalore Torpedo.* The model described in Ref 1, p 236 looks different from *Model 99 (1939)* described in Ref 2, pp 215–16 and in Ref 7, p 186. This torpedo consisted of a steel tube with shoulders welded to both ends. One end was internally threaded to take the igniter locking collar while the other end was threaded externally to take the pointed nose cover. The igniter system consisted of two pull igniters screwed into an igniter holder which fitted into the igniter locking collar. The rings of the igniters were connected by lines to the lanyard holder. The igniters were simple match compn pull igniters, friction type, with a BkPdr delay of 8 seconds, an initiant, and a base chge of Tetryl. Each torpedo unit had outside diameter of 1-13/32 inches, total length 51 feet, weight 10 lbs, filled with 3 lbs of 36.4/63.6–TNT/RDX as Bursting Charge. To prepare the

torpedo for use, the storage caps were removed from the required number of tubes and were screwed end for end together. Then the pointed nose cover was screwed onto one end, while at the other end the igniter locking collar was screwed into it. After placing the torpedo on the ground or barbed wires, etc, the safety pin of igniter was removed and the firing lanyard pulled sharply (See Fig 162, p 216 of Ref 2 and description and Fig on p 186 of Ref 7)

The bangalores were used primarily for destruction of wire entanglements, but also to clear passages thru mine fields and destroy railroad tracks. They may be rigged as booby traps (Compare with US Models described in Vol. 2 of Encycl, pp B16-B17)

b) *Bamboo Tube*, filled with explosive and fitted with a pull igniter is shown in Fig 386 on p 237 of Ref 1

c) *Finned Bangalore Tube*, shown in Fig 387, p 237 of Ref 1 and in Fig 299, p 376 of Ref 2, was similar to a regular Bangalore, except that it was made of two pieces with fins attached to the after-body. This section was made to fit into the barrel of the Type 98 Projectile Discharger. A combination Instantaneous-Short Delay Nose Fuze was fitted into the tube. Diameter of tube 1-15/16 & length 78-3/8 inches; total weight 17 lbs, 14 oz

d) *Type 99 Demolition Tube* was 44 inches long and weighed 35kg. The fuze was actuated by a pull cord and had 7 seconds delay (Ref 1, p 237)

e) *Obstacle Demolition Tube* was over 35 feet long and weighed 102kg. Its construction was similar to those above but the fuze was actuated by electrical means (Ref 1, p 237)

Denkayaku. Booster Charge. See under GAINÉ

Denki bakkan. Electric Primer

Denki tengaku. Electric Blasting Machine; Exploder

Density. Mitsudo

Density of Loading. Sōten hijū

Depth Bomb; Depth Charge (Bakurai). Accdg to Ref 1, p 61, the depth chges of Japanses Navy, like its mines but unlike its torpedoes, are obsolete in design

The following types were used during WWII: Type 88 Depth Charge was a metallic barrel 30.5 inches long and 17.7 inches in diam. This size was standard for all known depth charges. It was filled with 327 lbs of cast PA (Shimose). It had "filling end" and "pistol end". The hydrostatic pistol was operated by water pressure and could be set to fire at depths of 82 or 148 ft by varying the opposing spring pressure (p 62 of Ref 1);

Type 91 Model 1 Modification 1 Depth Charge was similar to above and contd 220 lbs of Type 88 (qv) Expl. Operated at depths of 82 or 164 ft of water (p 62);

Type 95 Depth Charge (Fig 33) was the regular issue charge until the appearance of the Type 2. It contd 220 lbs of Type 88 Expl. Slow ships dropped the chge to slow down its rate of descent so that the ship could escape the danger area before the chge exploded. The hydrostatic pistol (Fig 34 on p 62) could be set for a depth of 98 ft with parachute or 197 ft w/o one;

Type 95 Mod 1 contd 325 lbs of Type 97 or 98 Expl (p 62);

Type 2 Depth Charge (Fig 35 on p 63) was loaded with 240 lbs of Type 1 Expl. This depth chge and its hydrostatic pistol (Fig 36 on p 63) were almost direct copies of British models. The pistol could be set for depths of 98, 197, 292, 390 and 480 feet (pp 62-3); Type 2 Mod 1 Depth Charge contd 357 lbs of Type 98 Expl or Type 97 as an alternate filling (p 63);

Type 2 Mod 2 Depth Charge was filled with either Type 1 or 4 Expl (p 63);

50 Kilogram Army Depth Charge (Fig 37 on p 64) was 20 inches long, 13 inches in diameter and carried a chge of approx 75 lbs of TNT.

The firing mechanism (instead of hydrostatic pistol) was housed in a well at one end of the case. It was probably used on "suicide boats" (qv); Type 3 120 Kilogram Army Depth Charge (Experimental) was 24½ inches long and 15¼ inches in diameter, filled with 200 lbs of HE (no data). It was fired by a pull igniter instead

of a hydrostatic pistol. The charge (Fig 38 on p 63 of Ref 1) was rigged on Army "suicide crash boats". The charge was also used as a Mine and could be fired electrically by means of Demolition Charges planted beside it (Ref 1, p 223)

Destruction. Hakai

Detonating Cap. Raikan

Detonating Charge; Detonating Explosive. Kibakusai

Detonating Cord. Dōbakusaku

Detonating Fuze. Shinkan; Bakkan

Detonation. Kibaku; Bakuhatu

Detonator. Kibakuyaku

Device. Dōgu, Sōchi, Shikake

Dōbakusaku. Detonating Cord

Dōkaraikan. Nonelectric Cap

Dōkasaku. Safety Fuse; Powder Train

Dōkasen. Explosive Train; Powder Train

Dokuen. Poisonous Smoke

Dokugasu. Poisonous Gas

Double-Base Propellant. See Nitoroguriserin muenyaku under PROPELLANTS

Drill Ammunition. Giseidan

Drill Bomb. Gibakudan

Drop Test. Rakka shiken

Dud. Fuhatsudan

Dumdum Bullet. Damudamu dan

Dummy Ammunition. Renshūyō danyaku

Dummy Projectile. Giseidan

Duralumin. Jurarumin

Dynamite. Dainamaito (qv)

"E" (Explosive). A light-yellow castable expl mixture of Trinitroanisole 60 & AN 40%; cast density 1.60; Power by Ballistic Mortar 108% (PA=100%). No info about its uses (Ref 5, p 364)

Eikadan. Time Shell

Eika shinkan. Time Fuze

Eikōdan. Tracer Bullet

Eikō danyaku. Tracer Ammunition

Ekka. Liquid Fire

Electric Current. Denryū

Electric Firing Device Type 3 for Proximity Fuzing of Bombs is described in Ref 2, pp 188-89 with Fig 137

Electric Primer. Denki bakkan

Electric Wire. Densen

Electron. Denshi

Electron Bomb. Elekutoron shōidan

Emmaku. Smoke Screen

Emmaku hōshaki. Smoke Projector

Enka. Signal Rocket

Enkapikurin. Chloropicrin

Enka shingō. Pyrotechnic Signal

Ennayaku. A light-yellow expl mixture of K chlorate 80, MNT (Mononitrotoluene) 15 & castor oil 5%; extremely sensitive to mechanical action. It was used by the Army as Substitute

Demolition Charge and as Substitute Main Charge for Hand Grenades and Mortars (Ref 1, p 28 & Ref 5, p 364)

Enoki Dynamite No 2. See under *Dainamaito*

Enshūyō bakudan. Practice Bomb

Enshūyō dangan. Practice Shell

Enshūyō jirai. Practice Land Mine

Enshūyō kirai. Practice Sea Mine

Enshūyō tekidan. Practice Grenade

Entai. Trench; Shelter

Entoyaku. A light-yellow expl mixture of K chlorate 80, DNT (Dinitrotoluene) 16 & castor oil 4%; used for the same items as *Ennayaku* (Ref 1, p 28)

Equipment. *Sōgu*

Erosion (of Gun Barrel). *Fushoku*

Exploder. *Bakuhaki*

Explosion. *Haretsu; Bakuatsu*

Explosive. *Bakukatsubutsu; Bakuyaku.* See under individual name: *Akatsuki, Angayaku, Chakatsuyaku,* etc and under "Unknown Name Explosives"

Explosive Bullet. *Bakuretsu shōjūdan*

Explosive Coal, Food Can and Toothpaste. See under *Sabotage Devices*

Explosive Train (in Fuze). *Dōkassen*

Exterior Ballistics. *Tōgai dandōgaku*

Factory. *Kōjō*

Field Gun; Field Piece. *Yasenhō*

Filler. *Sakuyaku*

Finned Bangalore Torpedo. See under *DEMOLITION TUBES*

Fireworks. *Enka*

Firing (Discharge of a Firearm). *Hassha*

Firing Devices. See under *Igniters or Firing Devices*

Firing Pin (Striker). *Gekishin*

Firing Pin of Fuze. *Kakki*

Fixed Ammunition or Fixed Round. *Kanzen yakutō*

Fixed Gun. *Koteijū*

FLARES (Shōmei) and Flare Bombs (Shomeidan)

The following **Japanese Army Flares** (excluding Parachute Types) are described in Ref 1, pp 238-43:

Flares for 50-mm Type 10th Year Flare Discharger (p 238 & Fig 388 on p 239) had heavy cardboard cylindrical bodies, 6-1/8 inches long, filled with various color flare compositions. A proplnt container was attached at the base;

50-mm 10th Year Type "A" Flare (p 238 & Fig 389 on p 239) was a heavy cardboard cylinder 6 1/4 inches long, which contd a filling of an incendiary type which burned with an intense white flame. It was fired from the Type 89 Grenade Discharger. A cylindrical proplnt container was attached at the base;

81-mm Mortar Signal Flare. Its Green Type was a light iron cylindrical case 3 inches in diam & 7-3/8 inches long loaded with green flare compn. Attached to the base was a proplnt container (p 239);

81-mm Mortar Parachute Smoke Flare was similar to above but contd smoke producing compn (p 239);

Flare Signal Cartridges were cardboard cylinders 3 3/4"x1/16" filled with green, red or white flame producing compns. They were fired from the Type 97 Very Pistol (p 239);

Flare Signal Rocket Mk 1 Flare consisted of cardboard cylinder attached to a stick, to the end of which was fixed a 6 1/2 ft length of rope. A pull tape at the base of the rocket case

covered a length of fuse which was lit to fire the rocket (p 240);

Type 93 4-cm Signal Flare was in two types: a) Trailing White Stars and b) Green Comet. They are described on p 240 and illustrated in Fig 391;

Safety Fuse Flare, 3½ inches long and 1¼ inches in diam, was housed in a cylindrical paper container closed at the base with a wooden plug to which a short length of safety fuse was attached. Above the plug were small expelling & ignition chgs which blew the flare and its red paper parachute out of the container. The flare burned for 23 seconds. It could be fired from the 30-mm Rifle Grenade Discharger (p 240 & Fig 392)

The following *Japanese Army Parachute Flares* are described in Ref 1, pp 250-51 and in Ref 2, pp 22-5 with Figs 18, 19 & 20:

Type 90 Small Model Parachute Flare was a sheet-steel cylinder (with conical nose) 26¼ inches long & 2-7/8 inches in diam contg 4 lbs of an Illuminating Compn of Ba chlorate 75.2 & gum 24.8% and a BkPdr ignition chge. The flare burned for 2-2/3 minutes with an intense greenish-white flame. A detailed description is given on pp 22-3 with Fig 18;

Type 1 12-kg Parachute Flare was a sheet steel cylindrical (with conical nose) case 37 inches long & 4-3/16 inches in diam filled with 15 lbs of an illuminant which was ignited by BkPdr chge. Compn of illuminant was as indicated under Illuminants in the text. The Illuminant burned for 1½ to 3 mins with a greenish-white flame. A detailed description is given on pp 24-5 with Fig 19;

Type 3 Parachute Flare was a sheet steel cylindrical (with rounded nose) case 42½ inches long & 6¼ inches in diam filled with 15 lbs of illuminant, such as described in the text under I's and a BkPdr Igniter. A detailed description is given on pp 25-6 with Fig 20

The following *Japanese Navy Flares* (excluding Parachute Types) are described in Ref 1, pp 241-43 and some of them in Ref 2, pp 98-100 and 106-08:

Navy Hand Signal Flare was cardboard tube 12½ inches long filled with a flare mixture and fixed on a wood handle. The flare was ignited by a pull igniter wire which extended down the tube (p 241, Fig 393 of Ref 1);

Illuminating Flare Bomb was of thin iron, conical in shape with a hemispherical nose welded at the bottom. Length 22½ inches, diam at top 6¼ inches. Its filler was ignited by a pull igniter, resulting in a brilliant greenish-yellow light (p 241, Fig 394 of Ref 1);

Type 96 Floating Landing Flare was a sheet metal flare bomb with four sheet metal fins and a brass nose. Total length 16½ inches, diam 5 inches. Its flare mixt filler was ignited by a pull igniter. When dropped from an airplane it floated in water while producing an extremely bright light to signal landing spots during the night (p 241, Fig 395 of Ref 1 and p 98 of Ref 2 with Fig 74);

Navy Ground Signal Flares were cylindrical cardboard containers 3¾ inches long 1¾ inches in diam, filled with red, white or green compns. Used to signal aircraft from the ground (p 242, Fig 396 of Ref 1);

Type 94 Float Flare, called in Ref 2, p 107
Type 94 Float Light, was timplate cylinder, 12 inches long & 2¾ inches in diam, with a hemispherical nose. A lead in the nose and a buoyancy chamber at the base section kept the flare straight in the water. The body had water inlet holes in the nose and the side seated by tear-off strip and a removable end cap. Before dropping from a plane, the tear-strip and end cap were removed to allow the water, after impact, to enter thru the nose inlet holes, thus wetting Ca carbide in the forward end. This generated acetylene gas. Simultaneously, water entered thru the side inlet hole to wet Ca phosphide gas in the after end of the flare, thus generating phosphine. When acetylene passed thru the tail opening, it was ignited by the phosphine which spontaneously inflames on contact with the air (p 242, Fig 397 of Ref 1 and with more detailed illustrations on p 106 of Ref 2);

Type 94 Mod 1 Float Flare was a larger flare than Type 94. Length 20¼ inches & diam 4¾ inches (p 243, Fig 398 of Ref 1);

Type 94 Mod 2 Float Flare was a smaller version of Type 94. Length 9¾ inches & diam 2-3/8 inches (p 243, Fig 399 of Ref 1 and in Ref 2, pp 108-09, Fig 81);

Type 0 Model 1 Float Flare was similar in construction and operation to Type 94. Length 13¾ inches & diam 2-7/8 inches (p 243, Fig

400 of Ref 1 and in Ref 2, pp 108-09, Fig 81); Type 94 Experimental Float Light, described in Ref 2, p 107 and illustrated in Fig 80 of p 106, consisted of tin plate cylinder 21¼ inches long and 4¾ inches in diam. It contd Ca carbide & Ca phosphite. Its operation was exactly the same as the Type 94 Float Flare described above; Navy Flare Ball was a large cardboard sphere 9 inches in diam with a dome top covering a paper-covered BkPdr Fuse and a dome bottom contg BkPdr chge in a celluloid cap. The main container carried a cluster of 12 flares attached to a large green tissue parachute. The flare cluster was bedded in a quantity of cottonseed which filled most of the lower half of the sphere. A pull wire permitted removal of the top dome and allowed access to the BkPdr fuse for ignition (Ref 1, p 247, Fig 409)

The following *Japanese Navy Parachute Flares* are described in Ref 1, pp 251-54 and Ref 2, pp 100-05 with Figs 76, 77, 78 & 79: 5-Kilogram Parachute Flare Model 2 Modification 1 consisted of a light sheet steel cylindrical body 25-1/8 inches long & 3-1/8 inches in diam, contg 5½ lbs of Illuminant (qv under I's), a Pull Igniter and a Parachute. The unit burned for 1½ mins giving brilliant white light. Detailed description is on pp 100-01 with Fig 76 in Ref 2; Type 0 Parachute Flares Model 1 and Model 1 Modification 1, each consisted of sheet steel cylinders 42½ inches long & 6¾ inches in diam, contg 66 lbs of Illuminant, a Fuze and a Parachute. They burned for 3-2/3 mins with a bright white light (Ref 1, p 252, Figs 421 & 422). Detailed description is on pp 102-03 with Fig 77 in Ref 2;

Type 0 Parachute Flares Model 2 and Model 3, Modification 1 consisted of sheet steel cylindrical bodies 35½ & 39½ inches long and 6¾ inches in diam each. Each contd 66 lbs of Illuminant, a Fuze and a Parachute. The flares shed a bright white light during 3-2/3 seconds (Ref 1, p 253, Figs 425 & 426). Detailed description is on pp 103-04 with Fig 78 in Ref 2; Experimental Model 11 Parachute Flares consisted of sheet steel cylindrical bodies 43¼ inches long & 9¼ inches in diam, provided with fins. One of the models had conical nose while the other had ogival nose. Each unit contd 68 lbs of Illuminant, a Fuze and a Parachute. The flare

burned with bright white light during 4-2/3 mins (Ref 1, pp 253-54, Figs 427 & 428). Detailed description is on pp 105 & 107, with Fig 79 in Ref 2;

Type 94 Float Light is described as Type 94 Float Flare in Ref 1, p 242 and also in this Section, under FLARES

Floating Flare (Fuhyō shōmei). See under FLARES

Float Lights, Type 94, Type 94 Experimental, Type 94 Model 2 and Type 0 Model 1, described in Ref 2 on pp 107-09 with Figs 80 & 81 as Float Lights are described here as "Float Flares" under FLARES

Floating Mine (Fuhyō suirai). See under MINE, SEA

Floating Smoke Items. See under "Smoke Floats"

Fosugen. Phosgene

Fragmentation Bomb (Sairetsu tōka bakudan). See under BOMB

Fragmentation Grenade (Sairetsu teryūdan). See under GRENADE

Frangible Grenade. Kaembin

Friction Primer. Monkan

Fuel Oil. Nenryōyu

Fuhatsudan. Dud

Fuhatsu suru. Misfire

Furyū suirai. Drifting Mine

Fuse (Kayōhen or Fyūzo). See under Demolition Equipment

Fuse, Safety. Dōkasaku

Fusetsu kirai. Anchored Mine

Fusetsu suirai. Submarine Mine. See MINE, SEA

FUZES (Shinkan)

Japanese Fuzes are divided into Bomb Fuzes and Projectile Fuzes which, in turn, are subdivided into Army and Navy Fuzes

A. Bomb Fuzes are described in OPNAV 30-3M (1945), listed here as Ref 1, pp 80-88 (Army Bomb Fuzes) and pp 110-21 (Navy Bomb Fuzes). More complete description is given in TM 9-1985-4 (1953), listed here as Ref 3, pp 123-54 (Army Bomb Fuzes) and pp 155-87 (Navy Bomb Fuzes)

Individual fuzes of each service are generally interchangeable for use in bombs of that service, but not interchangeable for use in ordnance of the other service

The following **Army Bomb Fuzes** are listed in Ref 2 on pages indicated below:

Type 93 Instantaneous-Short Delay A-2(a) (pp 123-24)
 Type 12-Year Instantaneous A-2(b) (pp 124-25)
 Type 99 Instantaneous-Short Delay A-2(c) (pp 126-27)
 Type 1 Instantaneous A-2(d) (pp 127-28)
 Type 92 Nose Fuze A-4(a) (p 129)
 Fuzes for Type 3 Bomb A-6(a) and A-6(b) (pp 129-32)
 Fuze for Type 2 Bomb A-7(a) (pp 132-33)
 Type 4 Two-Second Delay Fuzes A-8(a) & A-8(b) (pp 134-36)
 Type 12-Year Tail Fuze B-1(a) (pp 137-38)
 Type 1 15-Second Delay Fuze B-1(b) (pp 138-39)
 Type 92 Tail Fuze B-4(a) (p 140)
 B-4(a) Tail Fuze (p 141)
 Experimental 3.5-Second Delay Fuze B-7(a) (pp 141-43)
 Type 4 Five-Second Delay Fuze B-8(a) (pp 143-44)
 Type 1 Long-Delay Fuze C-3(a) (pp 144-47)
 Aerial-Burst Fuzes D-1(a) & D-1(b) (pp 147-49)
 Type 1 Aerial-Burst D-5(a) & Combination Fuze D-5(b) (pp 149-51)
 Type 1 Antiwithdrawal Fuze E-1(a) (pp 151-53)
 Remote Control Radio Fuze (p 153)

The following are **Navy Bomb Fuzes** described in Ref 2 on pp indicated below:

A-1(a), A-1(b), and A-1(c) Nose Fuzes (pp 154-55)
 Type 97 Mk 2 Nose Fuze Model 2 A-3(a) (pp 156-57)
 Type 1 Nose Fuze Model 2 A-3(b) (pp 157-59)
 Type 2 Nose Initiator A-3(c) (pp 159-60)
 Type 97 Mk 2 Nose Fuze Model 1 A-3(d) (pp 160-62)

Type 3 Nose Initiator A-3(e) (pp 162-63)
 Type 2 No 50 Ordinary Bomb Model 1 Fuze A-3(f) (pp 163-64)
 A-3(g) Bomb Fuze (pp 165-66)
 A-5(a) Nose Fuze (pp 166-67)
 Type 99 No 25 Ordinary Bomb Fuze B-2(a) (pp 168-69)
 Type 99 No 80 Mk 5 Bomb Fuze B-2(b) (pp 169-70)
 Type 15 Tail Fuzes Model 2 & Model 1 B-3(a) & B-3(b) (pp 170-72)
 B-5(b) and B-5(c) Tail Fuzes (pp 172-75)
 Type 97 Rail Initiator B-6(a) (p 176)
 B-9(a) and B-10(a) Tail Fuzes (pp 177-79)
 Type 99 Special Bomb Tail Fuze C-1(a) (pp 179-80)
 Type 99 Special Bomb Nose Fuze C-2(a) (pp 181-82)
 D-2(a), D-2(b) and D-2(c) Aerial Burst Tail Fuzes (pp 182-85)
 D-3(a) Aerial Burst Nose Fuze (pp 186-87)
 Fuze for Type 0 Parachute Flare, Model 1 D-4(a) (pp 187-88)
 Type 3 Electric Firing Device for Proximity Fuzing of Bombs (pp 188-89)
B. Projectile Fuzes are described in OPNAV 30-3M (1945), listed here as Ref 1, pp 166-69 (Army Projectile Fuzes) and pp 191-94 (Navy Projectile Fuzes). More complete description is given in TM 9-1985-5 (1953), listed here as Ref 3, pp 391-426 (Army Projectile Fuzes) and pp 518-43 (Navy Projectile Fuzes)
 The following **Army Projectile Fuzes** are listed in Ref 3 on pp indicated below:
 Type 93, Type 100, Type 2 and Type 2 Modified Small Instantaneous Fuzes (pp 391-94)
 Type 4 Super Detonating Fuze (p 395)
 Ho 301 Impact Fuze (p 396)
 Type 88 Fuzes: Small Instantaneous, Short-Delay and Instantaneous (pp 397-400)
 Types 90, 93 & 100 Instantaneous Short-Delay (pp 401-04)
 Finned Bangalore Torpedo Fuze (pp 404-05)
 Type 98 Interior Fuze (pp 405-06)
 Type 89 Small Time Fuze (pp 406-07)
 Type 89 Powder Time Fuze (pp 408-09)
 Auxiliary Detonating Fuze (pp 409-10)
 Type 3rd & 5th-Year Combination Powder Time and Impact Fuzes (pp 410-12)
 Type 100 Mechanical Time & Impact Fuze (pp 412-13)

Type 2 Combination Powder Time & Impact Fuze (pp 414-15)

Type 94 Small Delay Base Fuze (pp 415-16)

Type 92 Small Short Delay Base Fuze (pp 416-17)

Small Mk 2 & Mk 1 Base Detonating Fuzes (pp 417-19)

Medium Mk 1 Impact Base Fuze (p 420)

Type 88 Small (Howitzer-Mortar) Base Fuze (pp 421-22)

Type 88 Small (Gun) Base Fuze (p 422)

Type 95 Large Mk 2 Mod 1 Base Fuze (pp 423-24)

Type 95 Medium Base Fuze (pp 425-26)

Fuze Cap. Shinkambō

Fuze Detonator. Shinkan no kibakuzai

Fyūzo. Fuse

GAINES (Fukutō) and BOOSTERS (Denkayaku)

Generally speaking *Gaine* is a container (sheath) for a *Booster*. More detailed info about Boosters is given in Vol 2 of Encycl, pp B243-R to B246-R and about Gains in Vol 6, pp G6-L to G7-L

Japanese Gains are divided into *Army Gains* (Ref 1, pp 88-9 and Ref 2, p 190) and *Navy Gains* (Ref 1, pp 121-22 with Table and Ref 2, pp 191-92)

Accdg to Ref 1, p 88 and Ref 2, p 190, Japanese *Army Fuzes* utilized a characteristic type of *Gaine* which differed greatly from that used in Navy Fuzes. Gains used in Army Bombs are shown in Fig 107, p 88 of Ref 1 and in Fig 138 of Ref 2. They were of brass construction and were screwed into the Fuze. There were three Types, of which Types I & II were used in the Nose, while Type II was used in the Tail Fuzes. Types I and III were ignited by the flash from the Primer in the Fuze, while Type II *Gaine* was pierced directly with the firing pin (because it was used in Fuzes having no internal Primer)

Army Boosters were either contained in a brass cup threaded into the Fuze around the *Gaine*, or in a paper cylinder housed in the main expl chge of the Bomb

Accdg to Ref 1, p 25, PA under the name

Oshokayaku was the main Booster Charge, while Tetryl (Meiyaku) and RDX (Shouyaku) were used in Sub-Boosters) (p 26)

Accdg to Ref 1, p 121 and Ref 2, p 191, Japanese *Navy Fuzes* utilized a characteristic *Gaine* which incorporated within itself the entire expl train. The Gains were similar in external appearance but varied in size and internal construction. They were generally made of brass, cadmium plated and lacquered. More recently some Gains were made of steel

A Table listing Navy Gains used during WWII is given in Ref 1, p 121, while on p 122 are given external views of six Gains. PA (Oshokayaku) was used as a main Booster Charge (p 31), Tetryl (Meiyaku) as Sub-booster, and as Auxiliary Booster 70/30 TNAnisole/HNDPhA (H2 Kongo-H2 Mixture), abbr for Type 98 Expl (p 31)

Following Navy Gains are listed and illustrated in Ref 2 on pages indicated:

Type 97 Land Bomb *Gaine* "A" and Type 99 Ordinary Bomb *Gaine* "A"; length 4½ inches, depth 1-3/8 inches. Explosive Train: Primer compn in upper plug; BkPdr delay (0.03 sec) over flash pdr relay in middle plug; Lead Azide detonator over Tetryl in lower plug and PA Booster (p 192 & Fig 140)

Type 97 Land Bomb *Gaine* "B" and Type 99 Ordinary Bomb *Gaine* "C". Same size and Expl Trains, but their delays were 0.2 & 0.1 sec, respectively (p 193, Fig 141)

Type 15 Ordinary Bomb *Gaine*. Same size and Expl Train as above, but its delay was selective from fractional to 1.5 secs (p 194, Fig 142)

Type 92 Land Bomb *Gaine* Modification 2. Same size but it was Instantaneous and its Expl Train was: MF (Mercuric Fulminate) over Tetryl in an inverted copper cup in upper plug; no delay chge; Tetryl pellet in lower plug and PA Booster (p 195, Fig 143)

Type 96 Land Bomb *Gaine*. Same size as above, and Expl Train same as in Types 97, 99 & 15 with delay chge absent (p 196, Fig 144)

Type 4 *Gaine* for Skipping Bomb. Same size as above with Expl Train: Primer compn in upper plug; circular BkPdr Delay Train (10 to 11 secs) and Relay in middle plug; Primer compn over LA Detonator over Tetryl pellet in lower plug; PA Booster (p 197, Fig 145)

Type 1 Mk 2 Bomb *Gaine* "A". Same size and

Train as above, but delay was 3.5 ± 1.0 sec (p 198, Fig 146)

Type 0 Mk 5 Bomb Gaine, length $6\frac{1}{2}$ & depth $1\frac{3}{4}$ inches. Same Expl Train as above but delay was 0.2 sec (p 199, Fig 147)

Electric Bomb Gaine, Instantaneous, length $5\text{-}3/8$ & depth $1\text{-}3/8$ inches. Expl Train: The Electric Blasting Cap fitted into hollowed-out cavity in the PA Booster. Leads from the cap ran up to a female plug which was attached by a special adapter to the standard Gaine body (p 199, Fig 148)

Type 2 Small Model Bomb Gaine Model 1, Instantaneous. Length 3, depth $13/16$ inches. Expl Train: MF cap over Tetryl in upper plug; PA Booster (p 200, Fig 149)

Practice Bomb Gaine, Instantaneous. Length $3\text{-}1/8$, depth $11/16$ inches. Expl Train: MF in upper plug; Tetryl Booster (p 200, Fig 150)
(See also Magazines)

Gasu. Gas, Chemical Agent

Gasubakudan. Gas Bomb

Gasudan. Gas Shell, Chemical Shell

Gasu tekidan. Gas Grenade

Gekishin or Gekkei. Firing Pin

Glide Bomb. Kaku bakudan

Glycerin. Guriserin

Gomu. Rubber

Graphite. Sekiboku

Granel. Hikkake-ikari

GRENADES (Tekidan). There are **Hand Grenades** (Teryūdan), **Rifle Grenades** (Jūyō tekidan) and **Mortar Grenades** (Kyūhō tekidan)

Accdg to Ref 2, p 225, the Japanese Armed Forces developed both before and during WWII a fairly extensive line of Grenades. This type of Ordnance primarily used by ground Forces was developed by the Army, but was also used by the Navy Ground Defense Units. Many Grenades were improvised and some of them, such

as of glass construction were dangerous to use. Rifle (as well as Mortar) Grenades were often modified Hand Grenades.

The following Grenades are described in Refs 1 & 2 on pages indicated under each item:

Type 91 Hand, Mortar or Rifle Grenade had a cast iron cylindrical body $3\frac{3}{4}$ inches long & 2 inches in diam. It had 50 serrated segments and contd 65g of powdered TNT. Its delay was 3 secs (Ref 1, p 195 & Ref 2, p 225 with Fig 169 on p 224)

Type 97 Hand Grenade had a cylindrical, serrated, cast iron or aluminum body, 4 by 2 inches, contg powdered TNT. It was similar to Type 91 except that the base of Type 97 was solid and could not take a propelling charge which is required for conversion to Rifle or Mortar Type. Therefore, it could only be used as a Hand Grenade Delay 4–5 seconds (Ref 1, p 195 & Ref 2, p 226 with Fig 170)

Type 99 Hand Grenade had a cast-steel cylindrical body $3\frac{1}{2}$ by 2 inches with smooth surface, filled with cast PA. Delay 4–5 secs (Ref 2, p 227 with Fig 171). In Ref 1, pp 195–96, this Grenade was subdivided into Type "A" (**Kiska** Type) (Fig 299) and Type "B" (Fig 300)

Type 4 Pottery Hand Grenade had spherical terra cotta body 3 inches in diam with wall $7/16$ inch thick. It contd 3.5 oz of Type 88 Explosive and had 4–5 secs delay (Ref 2, p 228 with Fig 172 & Ref 1, p 197)

Type 23 Pull Type Hand Grenade had a cylindrical cast-steel body $3\frac{1}{2}$ by 2 inches, with five transverse depressions, used instead of serrations. It contd 39.5g of granular TNT and had a $5\frac{1}{2}$ -sec delay (Ref 2, p 229 with Fig 173 & Ref 1, p 196)

Type 98 Stick Hand Grenade had cylindrical, cast steel body, $7\frac{3}{4}$ inches long and $1\text{-}5/16$ inches in diam, with smooth surface. It contd 3 oz of cast PA (Shimose) and had a 4–5-sec delay (Ref 2, p 230 with Fig 174 & Ref 1, p 196)

Type 3 Conical Antitank Hand Grenade, called in Ref 1, p 196, "Type 3 Conical Hand-Thrown Mine", existed in "large" and "small" sizes.

The basic principles of construction were the same in both cases, but variations occurred in measurements, weights and the expl charges. Each Grenade consisted of a cone-shaped expl chge (Type 94 for large and Pentolite for small), a metal cone and a wooden ring base, all contd in a

silk bag. A fuze was inserted and a grass or hemp tail attached to the apex of the chge. The expl chge was cast in the form of a truncated cone, thus making the Grenade Hollow (Shaped)-Charge Type. It was thrown against tanks.

Large type had body 6¾ inches long and diam at the base 4-3/8 inches, while smaller type had 5-7/8 & 4 inches, respectively. Length of the tail was 14 inches (Ref 2, pp 230-32 with Fig 175 and Ref 1, p 196)

Sling Hand Grenade had a cast steel cylindrical body which had a metal ring attached to its tapered wooden base plug covered with reinforcing cloth. Overall length 5-7/8, diam 1-13/16, filling 1 oz of TNT and delay 4 or 5 secs. Its fuze was friction-igniter type located in the nose. Grenade could be thrown either by hand or by a sling attached to the base ring (Ref 2, p 232 with Fig 176 & Ref 1, p 198)

1/2-kg Incendiary Hand or Mortar Grenade had brass cylindrical body, 5.6 inches long & 2.0 inches diam filled with WP (white phosphorus) and fuze. For projecting it from Mortar, Model 89, a steel propellant container was screwed into the base of the body. Delay was 4 to 5 secs. (Ref 2, pp 233-34 with Fig 177)

Incendiary Stick Grenade had light steel cylindrical body with hemispherical ends and wooden handle threaded into the base. Length of body 13.2 inches, diam 2.1 inches and length of handle 5.3 inches. The body was filled with 41 rubber pellets, each impregnated with a soln of WP in carbon disulfide. The pellets were scattered by means of a small central burster chge. It is possible that the Grenade was filled sometimes with a SP smoke filling (Ref 2, pp 234-35 with Fig 178 and Ref 1, p 200)

Molotov Cocktail, called "Frangible Incendiary Grenade" in Ref 1, p 200. Its body consisted of a Japanese beer bottle into the top of which was tightly fitted an "all-way" action fuze. The bottle, 11¾ inches long & 2-1/3 inches in diam was filled with ca 12 oz of an inflammable benzene-type liquid (Ref 2, pp 235-36 with Fig 179)

Phosphorus-Ignited Molotov Cocktail used a bottle 9¾ inches long & 2-1/8 inches diam, which contd 9.5 oz of 15% soln of polymethylmethacrylate in benzene and sealed with a crown type cap. An adjustable rubber harness held a flat circular glass igniter capsule, contg 1 oz

of RP (red phosphorus) to the base. The capsule was well protected in the carton (which held the Grenade) by several layers of cardboard and sawdust. Before launching the bottle, a rip cord was pulled to open the carton and the igniter capsule was secured to the base of the bottle by the rubber harness. When the bottle was thrown with force against a hard target it scattered and the friction betw the pieces of RP caused instant ignition of inflammable material. The viscous nature of the filling prevented undue splashing and insured adherence to the target (Ref 2, pp 236-38 with Fig 180 & Ref 1, p 201)

Hydrocyanic Acid (Seison) Frangible Grenades were round glass bowls, 3.9 inches in diam contg 12.2 fl oz of Cu-stabilized ca 80% strong HCN aq soln which acts as a very strong systemic poison. There were two types differing in minor details (Ref 2, pp 238-39 with Fig 181 & Ref 1, p 201)

Frangible Smoke Grenade consisted of a clear glass flat bottomed round flask 2.6 inches in diam, contg 4.1 oz of titanium and silicon tetrachloride. It was closed with rubber stopper and crown cap. Being thrown against a hard object, the bottle broke, releasing the liquid which in contact with air produced a smoke screen (Ref 1, p 201 with Fig 315 and Ref 2, p 239)

40-mm Hollow-Charge Rifle Grenade was light metal cylinder, 1.58 inches in diam, with a semiconical shaped head. Overall length 7.98 inches. It was made in two parts, threaded together and fitted with a ballistic cap and cone to give a hollow-charge effect. The forward part contd 3.81 oz of 50/50-RDX/TNT cast around the cone, while the after part had a rifled collar near the base and contd the Fuze and Expl Train. The Grenade was fired from a cup launcher attached to the standard 6.5-mm rifle (Ref 2, pp 239-40 with Fig 182)

30-mm Hollow-Charge Rifle Grenade was a smaller version of the above: overall length 6.25 inches, diam 1.18 inches and wt of HE chge 1.75 oz (Ref 2, p 241)

Model 3 Modification 1 Rifle Grenade was similar to the Type 99 Hand Grenade (known as "Kiska", described above in Ref 2, p 227) with a tail assembly added. It contd 3 oz of TNT as Main Charge and was intended to be

fired from the spigot type Grenade Launcher (Ref 2, pp 241-42 with Fig 183)

Smoke Rifle Grenade had a light-metal cylindrical body, 2 inches in diam with fins. It contd a mixture of hexachloroethane 56.2, Zn pdr 27.6, Zn chloride 2.9 & Zn oxide 13.4% (adds to 100.1%). It was used with a special adapter which fitted over the end of a rifle barrel (Ref 2, pp 243-44 with Fig 184) Small Incendiary Rifle Grenade had a light-metal cylindrical body 1-7/8 inches in diam filled with WP (white phosphorus). It was launched from a spigot type Rifle Grenade Launcher (Ref 2, pp 244-45 with Fig 185)

Improvised Grenades. Accdg to Ref 1, p 202 and Ref 2, p 225 a large variety of Grenades was made from such items as small ammunition, small bombs & shells, pipes, paper and wood. This was probably due to a shortage of materials. Most improvised items were ineffective and dangerous to use

The following improvised Grenades are listed in Ref 1, pp 202-03:

- a) Gas pipe, closed at both ends, filled with an expl and fitted with a .22 cartridge case and safety fuse as igniter
- b) 25-mm shell case filled with an expl and fitted with a pull igniter or a length of fuse
- c) Heavy paper or braided cord container filled with an expl and fitted with fuse
- d) 1/2-kg Army bombs removed from their containers, armed and thrown by hand (Fig 318)
- e) A very effective conical Grenade was constructed from the tail section of the Navy 30-kg Practice Bomb. The tail cone was removed and the space around the burster tube was filled with granular PA. Then a grass or hemp cord was attached and the B-6(a) Practice Bomb Tail Fuze fitted to the cone. After arming the Fuze by hand, the bomb was thrown (Fig 319 on p 203)

The following Grenades are described and excellently illustrated in the book of W.H. Tatum IV and E.J. Hoffschmidt, "Second World War-Japanese Combat Weapons", Vol 2 (1968), WE Inc, Old Greenwich, Conn 06870, listed as Ref 7:

- Hand Grenade Model 91 (1931) (p 173 with 2 Figs)
 Hand Grenade Model 97 (1937) (p 174 with 2 Figs)
 Hand Grenade Model 99 (1939) (Kiska) (p 175

with Fig)

Conical Antitank Hollow-Charge Hand Grenade (p 176 with 2 Figs)

Pottery Hand Grenade (p 177 with 3 Figs)

High Explosive Rifle Grenade Model 3 (p 177 with Fig)

Hand Stick Grenade, High Explosive (p 178 with 2 Figs)

Hand Stick Grenade, Incendiary (p 178 with 2 Figs)

Grenade Discharger (Tekidantō) and Grenade Launcher (Rifle) (Tekidanki). A Grenade can be launched by hand, by rifle, by mortar or by special *Grenade Launchers or Dischargers*. These items were usually modified rifles or mortars. There were also special adapters which fitted barrels of rifles. Most Rifle Grenades could be fired directly from rifles

The following special devices for launching grenades are listed in Ref 1:

50-mm Type 10th Year Grenade Discharger was the forerunner of the "Knee Mortar" (p 158) Type 89 Grenade Discharger, known as the "Knee Mortar" had a rifled bore and a provision for varying the range with fixed angle of elevation (pp 158-59)

The following devices are described in the book of Tatum & Hoffschmidt, listed as Ref 7: 50-mm Grenade Discharger Model 10 (1921) is the same as listed but not described above and in Ref 1, p 158. It was smooth-bore and weighed 5½ lbs. It could be carried by one soldier. It was used to discharge Model 91 Hand Grenade pyrotechnic signals and smoke shells. Range 175 yds (p 155 with Fig) 50-mm Grenade Discharger Model 89 (1929) was rifled-bore and weighed 10¼ lbs. Range for Model 91 Hand Grenade was 200 yds. It was also used for pyrotechnic signals, incendiary shells, etc (pp 156-57 with several Figs)

Rifle Grenade Launchers. The following types are described and illustrated on p 179 of Ref 7:

- 1) Type 2 or Cup Type Launcher which was patterned after the German Launcher fitted over the front sight of the rifle and had a short rifled barrel (See Fig). It fired both the 30-mm and 40-mm Hollow Charge Rifle Grenades, which could penetrate 3-7/8 inches of mild steel plate
- 2) Type 100 or Kiska Type Launcher, shown in

Fig, consisted of a tube which could be attached to either 6.5-mm or 7.7-mm Rifle. Ordinary ball ammo was used to launch the Grenade (the expanding gas from the fired cartridge was utilized to expel the grenade from the launcher), a feature which enabled the rifle to be carried with the launcher attached and ready for use as either a rifle or as a Grenade Launcher. The Type 99 Kiska Grenade was the only type used with the Launcher. Maximum range was 100 yds (p 179)

3) Spigot Type Grenade Launcher consisted of a rifled barrel threaded to an adapter. It was attached to either the 6.5-mm or 7.7-mm Rifle at the rear of the front sight. It was used to fire Type 91, Type 3 HE, and several types of Smoke and Incendiary Grenades (pp 179-80 with 3 Figs)

Gun (Hō) and Howitzer (Ryūdampō). See under ARTILLERY AND ITS WEAPONS

Gun Barrel. Hōshin

Guncotton. Menkayaku

Gunpowder. Kayaku or **Black Powder.** Koku-shokuyaku, also called Yuenyaku (Nonsmokeless Powder)

Gyokei suirai or Gyorai. Torpedo

Gyorai. Torpedo

Gyorai jitsuyō tōbu. Torpedo Warhead

H2 Kongo (H2 Mixture) or Type 98 (Explosive). Lemon-yel expl compns consisting of TNAns (Trinitroanisole) 60-70 & HNDPhA (Hexanitrodiphenylamine) 40-30%

The 60/40 mixt was cast-loaded to a density of 1.65; its mp 65-70°, Expln Temp 264° & higher; Brisance, by Copper Cylinder Crusher Test 100% (PA=100%); Power by Ballistic Mortar 96% (PA=100); Deton Velocity by Dautriche Method 7050m/sec; Impact Sensitivity with 15kg Weight 14cm (max wt for no explns); Friction Sensitivity 60kg (max pressure betw two rubbing surfaces for no explns). Used, under the name Type 98, in Navy Bombs, Depth Charges, Sea Mines and Torpedoes in

place of PA (Picric Acid)

The 70/30 mixt had Expln Temp 237-46°; Brisance by Sand Test 102% TNT; Power by Ballistic Mortar 109% TNT; Rifle Bullet Test 20% detonations; and Impact Sensitivity by PicArns Test 12.5 inches (TNT 14). It was reported to be toxic, not very stable, and reactive with metals in the presence of moisture. Used pressed by Army and Navy as an Auxiliary Booster in some Bombs and Shells (Ref 1, pp 31 & 32 and Ref 5, p 365)

Haensosan bakuyaku. See Type 88 (Ko)

Haishokuyaku (Gray Powder). A dark-gray, non-toxic expl compn: *No 1 Mixture* consisted of Amm Perchlorate 76.9, RDX 17.0, silicon carbide 1.3 & paraffin 4.8%; relative Power & Brisance greater than for PA, but it is less sensitive to impact and friction. Used in Army Standard Demolition Blocks; *No 2 Mixture* consisted of Amm Perchlorate 48, GuN (Guanidine Nitrate) 20, RDX 25 & paraffin 5%. It was a commercial mining expl, and also used in Army Demolition Blocks (Ref 1, p 28 & Ref 5, pp 365-66)

Hakaitō. Bangalore Torpedo. See under DEMOLITION TUBES

Hakai yaku. Demolition Charge

Hakō bakudan. Armor-Piercing Bomb

Hakōdan. AP Projectile

Hakō ryūdan. AP-HE Projectile

Hakū or Ryūkyū. Mortar

Hakugekine. Trench Mortar; Infantry Mortar

Hakurin. White Phosphorus; WP

Hand Grenade. Teryūdan. See under GRENADE

Haretsu. Burst, Explosion

Hasai bōryaku. Sabotage

Hassha. Discharge (of a Firearm)

Hasshadan. Projectile

Hatsuen or Hatsuendan. Smoke Bomb or Shell

Hatsuen tekidan. Smoke Grenade

Hatsuentō. Smoke Pot; Smoke Candle

Hatsuenzai. Smoke Agent

HE (High Explosive) Projectile. Ryūdan

Heavy Artillery. Jūhōhei

Heavy Gun. Jūhō

Heavy Machine Gun. Juki

Heiki. Ordnance, Weapon, Arm

Heikibu. Ordnance Department (Japan)

Heiki seizōsho. Ordnance Factory

Heikishō. Ordnance Depot (Japan)

Heineiyaku. Trinitrophenetole (TNPhnt) or Ethyl Picrate, $C_2H_5.O.C_6H_2(NO_2)_3$; mw 257.16, N 16.34%; yellowish crystals, mp 78 ; less powerful, less brisant and less sensitive to impact than TNAnisole; called Type 91 Expl by the Japanese Navy. Deton Vel of TNPhnt 6880m/sec vs 7640 for TNAns [Blatt, OSRD Rept 2014 (1944)]

Accdg to Ref 3, p 321, Heineiyaku was used as an alternate HE Filler (instead of TNT) in Type 90 7-cm (75-mm) HE Long-Pointed Projectile and in Type 94 7-cm (75-mm) High Explosive Projectile (Not listed in Ref 1)

It is listed as *Keineiyaku* in Ref 5, p 366 and is stated that it can be used as a Bursting Charge in Projectiles as a Booster Charge, either alone or in mixtures with PA

Heishi. Soldier

Herikopotā. Helicopter

High Explosive. Kōkyū bakuyaku

High Explosive Shell. Kōkyū ryūdan or Jiraidan

Hikoki. Airplane

Hikōsen. Airship; Dirigible

Hō. Gun; Artillery

Hōbi. Breech (Arty)

Hōdan. Shell

Hohei. Infantry

Hōhei. Artillery

Hōkō. Muzzle (Arty)

Hollow (Shaped) Charge [Ta(dan)] Japanese Ammunition (Senkōryūdan)

In the paper by A.J. Dere, "Adaptation of the Hollow Charge Principle of Explosives", published in Ordnance Sergeant, Vol 10, p 13 (Oct 1945), it was stated that Japanese used during WWII, the following Hollow Charge (HoC) items:

75-mm HoC Projectile for Type 41 Regimental or Mountain Gun

HoC Rifle Grenade, diam 2.7 inches, overall length 7.08 inches, which could be fired from a 6.5-mm Infantry Rifle, was modified and several of them were enclosed in a large bomb casing. This ensemble could be dropped on airfields to damage grounded aircraft

Accdg to TM 9-1985-4, listed here as Ref 2, the Army Type 2 1/3-kg Cluster Bomb contd Hollow Charge of 50/50-RDX/TNT (pp 29-30 with Fig 25). There were also Type 3 Conical Antitank Hand Grenade with HoC (pp 230-31 with Fig 175) and 30 & 40-mm HoC Rifle Grenades (pp 239-41 with Fig 182)

In TM 9-1985-5, listed here as Ref 3, the following HoC projectiles are described:
 Type 3 7-cm (70-mm) Army HoC Projectile (pp 305-06 with Fig 238)
 Type 2 7-cm (75-mm) Army HoC Projectile (pp 328-29 with Fig 257)

In the book of W.H. Tatum IV & E.J. Hoffschmidt, "Japanese Combat Weapons", WE Inc, Old Greenwich, Conn (1968), listed here as Ref 7, are described the following HoC items:
 a) Conical Antitank HoC Hand Grenade (p 176 with Fig). Their construction is identical with

Grenade described in Ref 2, pp 230-31

b) Antitank "Lunge Mine". This interesting device described on p 184 (with Figs) of Ref 7, consists of a conical-shaped hollow charge encased in a steel container, which was attached at its apex to a long wooden handle. Three legs, equally spaced around the wide base of the cone provided proper stand-off distance. A well in the apex of the chge contained the detonator which is activated by a striker. To operate the device the soldier removed the safety pin, and then using bayonet tactics, lunged forward striking the base of the cone squarely against the tank. When the legs of the mine struck the tank, the long handle was driven forward breaking the shear pin, and the striker was driven into the detonator, initiating expln of the chge which could penetrate steel plates 4 to 6 inches thick. This mine was considered as a "suicide weapon" (See also Ref 2, pp 208-09 with Fig 155)

Hōshaki. Projector; Discharger

Hōshayaku. Propellant

Hōshin. Gun Barrel; Gun Tube

Howitzer. Ryūdampō. See under ARTILLERY

Hydrocyanic Acid. Seisan

Hytteki. Target

IGNITER (Tenkayaku or Tengaku) or **FIRING DEVICE** (Hakkasochi). This includes: *Igniting Primer* (Tenka bakkan); *Igniting Fuze* (Tenka shinkan) and *Firing Mechanism* (Gekihatsu kikan)

Igniters are used for igniting propellant charges, pyrotechnics, some fuzes, demolition charges and some special items. The simplest igniters are safety matches and squibs which are used to ignite safety fuses

In Ref 1, pp 233-34 are described devices to ignite demolition charges which are briefly described here under **DEMOLITION CHARGES AND EQUIPMENT**

In Ref 2 are described the following items: Type 3 Electric Firing Device developed by the Navy experimentally for Proximity Fuzes (pp 188-89 with Fig 137)

Igniter System for Bangalore Torpedo is described under Demolition Tubes and in Ref 2, pp 215-17 with Fig 162

Mechanical Pull Igniter (pp 246-47 with Fig 186)

Friction Pull Igniters were: Red Type (length 2¾ inches) and Black Type (length 3-1/16 inches) (p 248 with Fig 187)

Waterproof Safety Fuse Igniter (pp 248-49 with Fig 188)

Trigger-Type Safety Fuse Igniter (pp 249-50 with Fig 189)

Booby-Trap Firing Device (pp 250-51 with Fig 190)

Time Firing Device Mk 1 (pp 256-57 with Fig 193)

Chemical Delay Firing Device (pp 257-58 with Fig 194 of Ref 2)

Firing Devices used in Land and Sea Mines are listed under **MINES**

Illuminating Compositions (Shōmei henso).

The following compositions are listed in Refs 2 & 3:

Illuminant for Type 90 Small Model Parachute Flare consisted of Ba chlorate 75.2 & gum 24.8%. The Flare, contg 4 lbs of compn, burned for 2-2/3 mins with an intense greenish-white light (pp 22-24)

Illuminant for Type 1 12-kg Parachute Flare consisted of Ba nitrate 77, Al 8.8, Mg 4.4, S 2.2 & paraffin 4.5 parts. The Flare, contg 27 lbs of compn, burned up to 3 mins with a greenish-white light (pp 24-25)

Illuminant for 5-kg Parachute Flare Model 2 Modification 1 consisted of Ba nitrate 55.5, Al 11.0, Mg 18.0 & wax 9.1 parts. The flare, contg 5½ lbs of compn, burned for 1½ mins with brilliant white flame (pp 100-101 of Ref 2)

Illuminant for 14-cm (140-mm) and 15.5-cm (155-mm) consisted of Ba nitrate, Mg & wax (pp 493 & 504 of Ref 3)

Illuminating Projectile (Shell) (Shōmeidan).

The following projectiles are listed in Ref 3:

Type 95 7-cm (70-mm) Illuminating Projectile (pp 306-07 with Fig 239)

Type 90 7-cm (75-mm) Illuminating Projectile (pp 338-39 with Fig 265)

12-cm (120-mm) Illuminating Projectile (pp 477-78 with Fig 389)

14-cm (140-mm) Illuminating Projectile (p 493 with Fig 404)

15.5-cm (155-mm) Illuminating Projectile (p 504 with Fig 415 of Ref 3)

Impact. Shōgeki

Impact Fuze. Shōgeki or Chakuhatsu shinkan

Incendiaries. (Shōsei).

Accdg to Ref 2, the following incendiaries were used by the Japanese during WWII:

- a) Thermite as in Army 1-kg and 5-kg Incend Bombs (pp 15–18)
- b) Rubber bungs (1 by 1 inch) impregnated with soln of phosphorus in CS₂ as in Army 50 & 100 kg Incend Bombs (pp 18–20)
- c) WP (white phosphorus) filled steel pellets as in Navy Type 99 No 3 Bomb (pp 63–64) and Type 3 No 6 Mk 3 Model 1 (pp 64–65)
- d) Steel cylinders contg an Incend mixture of Ba nitrate 35.8, ferric oxide 27.2, Al 13.6, Mg 10.3 & synthetic shavings 13.1%, as in Type No 25 Mk 3 Model 1 (pp 66–68)
- e) Thermite-filled electron firepots as in Type 98 No 7 Mk 6 Model 1 (pp 71–72)
- f) Central thermite core surrounded by solidified kerosene, petrol, alcohol mixture as in Model 2 of above Bomb (pp 72–73)
- g) Cylindrical Incend pellets (consisting of Ba nitrate 35, ferric oxide 28, Al 18 & remainder synthetic rubber resembling Thiokol arranged around central cardboard tube contg Igniter mixt (Ba nitrate 75.0, Al 24.5, oil 0.3 & moisture 0.2%) as in Type 1 No 7 Mk 6 Model 3 Modification 1 Bomb (pp 74–75)
- h) Incend Shrapnel consisting of short lengths of steel pipe filled with WP, as in Type 4 No 25 Mk 29 (pp 87–88)
- i) White Phosphorus as in 1/2-kg Incend Hand or Mortar Grenade (pp 233–34) and Small Incend Rifle Grenade (pp 244–45)
- j) Any inflammable benzene-type liquids, as in Molotov Cocktail (pp 235–38)
- k) Thermite as in Metal Incendiary Cylinders shown on p 261 of Ref 2
- l) Mixture of K chlorate, sulfur, ground coal (or sugar), iron filings and wax to form an “Incendiary Brick”, one of the Sabotage Devices (p 262)
- m) Mixture of Ba nitrate 30.4, paraffin 19.4, Mg 11.3, Al 11.1, rosin 10.9, ferrosferric oxide 9.1, NC 4.4 & gritty siliceous material

2.6% to form an “Incendiary Soap”, one of the Sabotage items (p 263)

The following Incendiaries are listed in Ref 3 for Army Projectiles:

- a) Unknown Incendiaries in 20-mm HEIncend Projectiles on pp 282–84; 20-mm HEIncend-Tracer (p 284); 20-mm Incend (Self-Destroying) (p 285); Type 2 & Type 2 Modified 20-mm HEI (p 286); 37-mm HEI Projs (pp 289–91); Type 90 7-cm (75-mm) Incend (p 337)
- b) Incendiary consisting of Ba nitrate, Al, Mg & wax, as in Type 4 20-mm HEI (Ma 202) Proj (pp 287–88)
- c) Solution of WP and rubber pellets in CS₂ as in Army 7-cm (75-mm) Liquid Incend Proj (pp 339–40)

The following Incendiaries are listed in Ref 3 for Navy Projectiles:

- d) WP in Al canister surrounded by graphited flake NC (p 442)
- e) WP as in 25-mm HEI Proj (pp 447–48); Type 2 and Type 5 HEI (p 452); 12-cm (120-mm) IncendShrapnel (pp 482–83)
- f) Steel pellets filled with a dry mixture of Mg 54, Ba dioxide 26, rubber 15, ferric oxide 1.5 & sulfur 3% as in 12.7-cm (127-mm) Incend-Shrapnel (pp 485–86)
- g) Unknown Incendiary as in 15-cm (152-mm) IncendShrapnel (p 500 of Ref 3)

The following Incendiaries used in Japanese Mortars are listed in Ref 3:

- h) Incendiary Mixture of K nitrate 47.7, Al 21.7, S 19.9, Sb trisulfide 6.1 & wax 2.8% as in Type 89 50-mm IncendMortar (pp 375–76)
- i) WP, carbon disulfide and rubber pellets as in Type 94 90-mm IncendMortar (pp 386–87)

Incendiary Bomb (Tōka shōidan). See under BOMBS

Incendiary Cylinder Mk 1 “A” Large. See Ref 1, p 249

Incendiary Grenade. (Shōiyō tekidan). See under GRENADES

Incendiary Projectile or Shell (Shōidan). See under ARTILLERY AMMUNITION

Indicator (Shijiki). See Markers or Indicators

Infantry. Hohei

INFANTRY WEAPONS (Hohei heiki). Under this title are described and illustrated on pp 39-78 of the book of Tantum & Hoffschmidt, listed here as Ref 7, the following weapons:

9-mm Revolver, Mod 28 (1898) (p 39)
 8-mm Automatic Pistol "Nambu" (pp 40-41)
 7-mm Baby "Nambu" (p 41)
 8-mm Automatic Pistol, Mod 14 (1925) (pp 42-43)
 8-mm Automatic Pistol, Mod 94 (1934) (pp 44-45)
 35-mm Pyrotechnic Pistol, Mod 10 (p 46)
 Triple Barrel Signed Pistol (p 47)
 6.5-mm Rifle, Mod 38 (1905) (p 48)
 6.5-mm Carbine, Mod 38 (1905) (p 49)
 6.5-mm Cavalry Carbine, Mod 44 (1911) (p 50)
 7.7-mm Paratrooper Rifles, Mod 99 (1939) and Mod 2 (1942) (pp 51-53)
 6.5-mm Sniper's Rifle, Mod 97 (1937) (p 54)
 8-mm Submachine Gun, Type 100 (1940) (p 55)
 8-mm Paratrooper's Submachine Gun, Type 100 (1940) (p 56)
 6.5-mm Tank Machine Gun, Mod 91 (1931) (p 57)
 6.5-mm Heavy Machine Gun, Mod 3 (1914) (pp 60-61)
 6.5-mm Light Machine Gun, Mod 96 (1936) (pp 62-63)
 7.7-mm Light Machine Gun, Mod 99 (1939) (p 64)
 7.7-mm Paratrooper's Machine Gun, Mod 99 (1939) (p 65)
 7.7-mm Tank Machine Gun, Mod 97 (1937) (pp 66-67)
 7.7-mm Heavy Machine Gun, Mod 92 (1932) (pp 68-69)
 7.7-mm Lewis Machine Gun, Mod 92 (1932) (pp 70-71)
 13-mm AA Machine Gun, Mod 93 (1933) (pp 72-73)
 20-mm Automatic AA/AT Cannon, Mod 98 (1938) (pp 74-75)
 20-mm Automatic AT
 20-mm Automatic AT Rifle, Mod 97 (1937) (pp 76-77)
 25-mm Dual & Triple Automatic AA/AT Cannon, Mod 96 (1936) (p 78)

Initiator. Kōkyū tenkayaku; Kibakosochi

Instantaneous Fuze. Shumpatsu shinkan

Interior Ballistics. Tōnai dandōgaku

Iperitto gasu. Mustard Gas

Iron. Tetsu

Jakusōyaku. Reduced Charge

Jet. Funshutsu

Jibaku. Self-Destroying

Jidōhō. Automatic Gun

Jidōhū. Automatic Rifle

Jippō. Ball Ammunition

Jirai. Land Mine

Jiraidan. High Explosive Shell

Jirai fusetsu. Mine Field

Jisei kirai. Magnetic Mine

Jitsudan. Live Ammunition

Jūbi kikan. Breech Mechanism

Jūhō. Heavy Gun

Jūhōhei. Heavy Artillery

Jūken. Bayonet

Jūki or Jūkikanjū. Heavy Machine Gun

Jūkō. Muzzle (SA).

Jūsensha. Heavy Tank

Jūshin. Rifle Barrel

Jūyō tekidan. Rifle Grenade

Kainbin. Frangible Grenade

Kaen hashhaki. Flame Thrower

Kagakudan tōshaki. Chemical Mortar

Kagaku heiki or Kaheizai. Chemical Agent, CWA

- Kagakusei tekidan.** Chemical Grenade
- Kagakusei tōkagan.** Chemical Bomb
- Kagakusha.** Chemist, Scientist
- Kagō.** Chemical Composition
- Kahō.** Gun (General)
- Kaiganhō.** Coast Artillery Guns
- Kaigun.** Navy
- Kakki.** Firing Pin
- Kakkōhō.** Smooth Bore Gun
- Kanōhō or Kanon.** Cannon (as opposed to Howitzer (called Ryūdanpō))
- Kanzen yakutō.** Fixed Ammo, Fixed Round
- Karitto.** Army explosive, originated as commercial expl **Calit** (qv). Its Navy modification is **Type 88 Explosive** (qv)
- Kasen.** Pyrotechnics
- Kasen hasshaki.** Pyrotechnic Projector
- Kasshokuyaku.** Brown Powder. Accdg to documents it was "Undercarbonized Black Powder". Use unknown, but presumably as a substitute for BKpdr (Ref 1, p 30 & Ref 5, p 366)
- Keihō.** Light Artillery
- Keikikanjū.** Light Machine Gun
- Keineyaku.** Accdg to Ref 3, p 321 it is Heineiyaku (qv)
- Ken.** Bayonet
- Keyaki.** Gelatine Dynamite
- Kibaku.** Detonation
- Kibakuyaku.** Initiating Composition. See *Bakufun* (Ref 1, p 25) and *Raibun* (Ref 1, p 25)
- Kibakuzai.** Primer Charge. See Chikkaen (Army) or Chikka namari (Navy), meaning LA (Lead Azide) and also Raikō (Army) and Raisan suigin (Navy) for MF (Mercuric Fulminate) (Ref 5, pp 366 & 369)
- Kidōshiki kahō.** Mobile Artillery
- Kihei.** Cavalry
- Kihū.** Carbine
- Kikanhō.** Machine Cannon
- Kikanjū.** Machine Gun
- Kirai.** Mine (Sea)
- Kiri Nos 1, 2 & 3.** Gelatin Dynamites Nos 1, 2 & 3
- Ko** (Explosive). Japanese Type Explosives, such as Type 88 (Ko)
- Kōchū.** Bore (Gun)
- Kōdan.** Flare, Signal Rocket, Star Shell
- Kōdō.** Gallery of Mine
- Kōjō.** Factory, Shop
- Kōjōhō.** Siege Gun
- Kōkakuhō.** Dual Purpose Gun (Navy)
- Kōkei.** Caliber
- Kōkūki.** Aircraft
- Kokushokuyaku.** Black Powder or **Yuenyaku**. Nonsmokeless Powder. Composition is not given. Used by the Army as a Main Charge in 20-mm Machine Gun Ammo, as an ejector chge in 70-mm Mortar Shells, Shrapnel Shells & Pyrotechnics; in Delays, Relays & Igniters for Bomb & Projectile Fuzes; and as a "Substitute Charge" for some Bombs, Grenades and Projectiles (Ref 1, p 27 & Ref 5, p 366)
- Also used by the Navy as an ejector charge for Illuminating Shells and Pyrotechnics (Ref 1, p 33)

Kōkyū bakuyaku. High Explosive

Kōkyū ryūdan. HE Shell

Kōseisendan. Semi Steel Cast Projectile

Kōsen. Groove, Rifling

Koshahō. Antiaircraft Gun

Koshitsu (Plastic) or Oshitsuyaku (?). A brown, putty-like expl compn consisting of RDX 80 to 85 & oil 20 to 15%. Brisance by Sand Test 108% TNT; Power by Ballistic Mortar 125% TNT; Detonation Velocity 7400m/sec vs 6900 for TNT; Impact & Friction Sensitivity — same order as for TNT; retains plasticity betw 0° (32°F) & 37.8° (100°F), becoming brittle below 0° and starting to exude oil above 37.8°. Used in Demolition Cartridges 4 inches long and 1.5 inches in diam and Hollow (Shaped) Demolition Cartridges (being 21% more effective than TNT Shaped Charges) (Ref 5, p 367)

Accdg to Ref 1, p 28, the term *Koshitsu* (meaning "plastic") may be a part of designation. Its compn was RDX 80 & vegetable oil 20%, and it was used in Demolition Rolls. There seems to be another plastic expl contg RDX which was a mixture with NG

Kō-Shuanbakuyaku. Ammonium Nitrate Dynamite

Kōtetsuban. Armor Plate

Kūchū haretsu. Air Blast

Kūchū hatsuendan. Smoke Bomb

Kūgun. Air Force

Kūrai. Aerial Torpedo

Kyodan. Heavy Shell; Heavy Bomb

Kyūhō. Artillery Mortar

Kyūhōdan. Artillery Mortar Shell

Kyūnen Kasaka. Quickmatch

LA. Abbrn for Lead Azide (See Chikkaen)

Land Mine. See under MINES

Lead (Pb). Namari

Lead Azide (LA). See Chikkaen (Army) & Chikka Namari (Navy)

Liquid Fire. Ekka

Livens Projector. Ribensu shiki

Load or Charge (of Explosive). Sōyaku

Long-Range Gun. Enkyori shagekihō

L-Shoan. Ammonium Nitrate Dynamite

Machine Cannon. Kikanhō

Machine Gun. Kikanjū

Magazines. There are several itaems called *magazines*. One for rifles and pistols is *Dansō* (in Japan), one for storage is *Danyakuko* and one is a cylindrical item which can be fitted to any Fuze that takes a standard Gaine (qv). Magazines are used to initiate Low Explosives such as BkPdr but never used in a HE filled Bomb

No Army Magazine Gains are listed in Refs 1 & 2, but Navy Magazines are listed in both Refs 1 & 2. In Ref 1 are listed on p 121 Type 98, Mk 6, Model 1 and Model 2 Bomb Gaine Magazines with 0.03-sec Delay and instantaneous, with Fig 185 on p 122. The same Magazines are listed in Ref 2 on p 201 with more detailed illustrations (p 201)

Magnesium Bomb. Maguneshūmu shōidan

Magnetic Mine. Jihoku

Markers or Indicators (Shishi-Keiki)

These devices can serve as target indicators signalling landing spots, navigation markers, disaster spot markers, etc

The following items, which might serve as Markers or Indicators are described in Ref 1: Navy Type 96 Floating Landing Flare (p 241, Fig 395)

Ground Signal Flare (p 242, Fig 396)

Type 94 Float Flares (pp 242-43, Figs 397 to 400)

Army Smoke Candles (pp 243-44, Fig 401)

Navy 40-kg Floating Smoke Generator (pp 244-45, Fig 402)

Navy Smoke Float (p 245, Fig 404)

Navy Smoke Flare (pp 245-46, Fig 404)

Type 2 Target Indicator (p 246, Fig 405)

Navy Navigation Markers:

Type 0 Model 1 & Model 2 (p 246, Figs 406 & 407)

Type 2 Model 11 (p 246, Fig 408)

Cardboard Type (p 246, no Fig)

Navy Type 2 Model 1 Torpedo Marker (p 249, Fig 413)

The following items which might serve as Markers or Indicators are described in Ref 2:

Navy Type 94 Float Lights (pp 106-08).

See under FLARES

2-kg and 43-kg Smoke Floats (pp 109-10).

See under Smoke Floats

Navy Sea Markers Type 0, Model 1, Model 2

were light metal cylinders with rounded nose and conical tail, provided with fins. They contd fine Al dust with 6.5% Zn dust. On impact with water the plug in the nose was forced into the body forcing the tail portion to be freed from the body, thereby scattering Al-Zn pdr, 1 oz of which covered 118 sq ft of water. Used as distress indicator (pp 110-11, Fig 84)

Navy Sea Marker Type 0 Cardboard Type, on impact with water broke and scatterd Al-Zn pdr over the surface of water (p 112)

Type 3 No 6 Target Marker Bomb consists of a steel cylinder with round nose and conical tail, provided with fins. The filling consisted of WP-filled steel pellets contd in steel canisters. The space not occupied by pellets was surrounded by loose WP. The canisters were covered with heavy wax coating. The nose-piece contd a Gaine well surrounded by charge of Type 98 Expl (p 113, Fig 85)

Type 2 2-kg Target Indicator consisted of a Bakelite cylinder with round nose and tail provided with fins. The filling consisted of liquid FM (Titanium Tetrachloride). This smoke mixture was scattered when the bomb was released from a plane, hit the target and broke (pp 113-14, Fig 86)

Masutādu gasu. Mustard Gas

Matsu. Blasting Gelatin

Mechanical Time Fuze. Takeishiki bakkan

Meiyaku (Army), Sanshoki (Navy?) or Mechiru Nitroamin. Tetryl or 2,4,6-Trinitrophenyl-methylnitramine,

$(\text{O}_2\text{N})_3\text{C}_6\text{H}_2\text{N}$ $\begin{cases} \text{CH}_3 \\ \text{NO}_2 \end{cases}$; mw 287.16, N 24.39%; cream to yellow crystals, density 1.73, mp 130°; Brisance by Sand Test 126% TNT; Impact Sensitivity with 2kg Wt, BurMinesApp 26cm vs 100 for TNT; Ignition Point 257° in 5 mins; Detonation Velocity 7850m/s vs 6900 for TNT; Power by Ballistic Mortar 130% TNT [AMCP 706-177 (1967), p 335]

Used by Japanese in pressed state as a standard Sub-Booster in Army and Navy Shells and occasionally as the sole Booster in Navy 25-mm Shells and as Burster in some Bombs and Shells. Also used in composite explosive Tanōyaku (qv) (Ref 1, pp 26, 31 & 33; Ref 5, p 367)

Menkayaku (Guncotton). Comp with *Shōkamen* (Nitrocellulose)

Menyaku. Same as Menkayaku

Military (adj). Rikugun no

MINES. Jirai (Land), Kirai (Sea), Suirai (Amphibian or Water) and Booby Traps (Yūgekiteki jirai)

Accdg to Ref 1, p 210 & Ref 2, p 203, although the use of Land Mines by the Japanese Forces was not as extensive as it was in Europe, they were important defensive weapons in the Pacific War. Also, because of the Japanese lack of effective A/Tk Artillery and the inequality of Armored Forces, mining and similar tactics became a mainstay of defense against mechanized equipment

Three features of land mining methods were especially important: 1) The relatively small number of standard, mass-produced mines and firing devices; 2) The prevalent use of extremely large expl charges which was wasteful and 3) The emphasis was placed on various types of controlled mines instead of by enemy activated ones. Firing devices operated by lanyards or

poles were very common.

Japanese mining techniques were characterized by an almost complete lack of uniformity.

In Chapter VI of Ref 1, entitled "Japanese Mines and Booby Traps" are briefly described and rather poorly illustrated various Army and Navy Land Mines (pp 210 to 228)

More comprehensive descriptions, with good illustrations, are given in Chapter 3 of Ref 2 for the following *Land Mines*:

Type 93 A/Tk (Antitank) and A/P (Anti-personnel) Land Mine, known as "Tape Measure" Mine, was a light metal cylinder 6 $\frac{1}{2}$ inches diam and 1 $\frac{1}{4}$ inches high, filled with 2-lbs of cast PA and Booster of pressed PA. It was activated by pressure on Percussion Primer located on top of Mine (pp 202-03, Fig 152). Described in Ref 7, p 183 as Land Mine Model 93 (1933)

Anti-Vehicular "Yardstick" Land Mine was an oval tube 3.35" x 1.8" in diam and 36" long, formed by two halves of sheet steel welded together. It contd 8 blocks of cast PA wrapped in paper (wt 6 lbs) and a Fuze which could be activated by strong pressure such as of a vehicle (pp 204-06, Fig 153). Described in Ref 7, p 187 with Figs

Type 99 Armor-Penetration Land Mine was canvas disc 4.75" in diam & 1.5" wide, filled with cast blocks of 50/50-RDX/TNT forming a circle. Four magnets were attached around the circumference, which were designed for attaching the mine to the side of a tank or other vehicle. (pp 206-07, Fig 154). Described in Ref 7, p 181 as "Magnetic" Antitank Mine Model 99 (1939)

Antitank "Lunge" Mine (p 208, Fig 155) is also described here under "Hollow Charge Japanese Ammunition" and in the book of Tatum & Hoffschmidt, listed as Ref 7 (p 184)

Suction-Cup Mine consisted of sheet metal cylinder filled with ca 4.5 lbs of 53/47-RDX/TNT and provided on top with a 5 ft pole. Two suction cups at the bottom of the mine secured it to target when pressed. Ignition was made by two Friction Pull Igniters which were lashed to the bottom of pole (p 209, Fig 156)

Dutch A/Tk-A/P Land Mine, known as "Mushroom Mine" consisted of a pressed steel low cylindrical body and a dome-shaped cover

made of the same material. It was filled with TNT (5 $\frac{1}{4}$ lbs) and contd a fuze. A spring held the cover off the fuze, but a pressure of 50 lbs was sufficient to activate it (pp 210-11, Fig 157)

Type 3(A) Antivehicular & Antipersonnel Mine, known as "Flower Pot", consisted of a terra cotta, low cylinder filled with Type 88 Explosive or with 50/50-Amatol. The fuze located on top of mine could be activated by pressure of ca 22 lbs (pp 211-12, Fig 158). Described in Ref 7, p 182 as "Navy Type 3 (Flower Pot) Land Mine-Small"

Type 3(B) A/Vehicular & A/P Land Mine consisted of a wooden box filled with Type 88 Expl (p 213, Fig 159)

Beehive A/P Land Mines, recovered on Okinawa, consisted of serrated cast-iron, hemispherical casing filled with ca 5 lbs TNT. A pressure of one person on a fuze located on the top was sufficient to initiate expln (p 214, Fig 160)

5-kg Hemispherical A/Tk Land Mine consisted of light metal casing filled with a HE (?) and a fuze mounted opposite the flat bottom. It was a suicide weapon, intended to be placed against an armored vehicle either by hand or by means of a pole attached to the case (p 215, Fig 161)

Bangalore Torpedo, described here under DEMOLITION TUBES could be used as a Land Mine (pp 215-17, Fig 162)

Pressure and Traction Land Mine consisted of a wooden box, the lid of which was held in place against the internal fingers on the top by stout springs, one in each corner. A wooden block was secured by two bolts to the underside of the lid and served to operate the pull igniter by pressure exerted on the cover. It was filled with 2 lbs of cast PA or TNT (pp 217-18; Fig 163)

Friction-Fuzed Land Mine consisted of a wooden box 13" long, 3" wide and 2.37" high contg 5 blocks of cast PA or TNT (3.5 lbs), detonator or igniter. To the igniter was attached a trip wire which extended out thru the end of the box and was secured to a tree or other fixed object (pp 218-19, Fig 164)

Improvised Land Mine consisted of a rectangular tin box with a cover fastened by friction tape. Two holes were roughly punctured in the cover thru which a grenade fuze or detonator projected. Contained in the box were: one Type

91 Hand Grenade and 12 blocks $1\frac{1}{2}$ " by $\frac{3}{4}$ " of 66.6/33.3-RDX/Al compn, each wrapped in waxed paper. It could be used as an A/Tk Mine when fuzed with an armed grenade or as an A/P Mine or Booby Trap when armed with pull or tension detonator (p 219, Fig 165) Air-Strip Land Mine consisted of 31 100-kg bombs stacked around PA blocks in which electrical detonators were inserted. The ensemble was under a turf-covered piece of sheet iron that would close the circle and fire the charge if the iron were lifted or depressed. A clock-work was also inserted to fire the chge if the iron were not depressed (p 220, Fig 166, upper half)

Improvised Antitank Land Mine consisted of a wooden board serving as a base of Mod 99 Armor-Piercing Mine on top of which was placed 2 lbs prepd chge of PA. Two Hand Grenades were placed at both sides of AP Mine and the ensemble was covered with a board. Pressure on the board fired fuzes in grenades and this fired by sympathetic detonation AP Mine and prepd charge of PA (p 220, Fig 166, lower half) Type JE Antiboat Land Mine consisted of a hemispherical steel body 20.24" in diam & 10.62" high contg 46.5 lbs of Type 98 Expl, with PA Booster and Electrical Tetryl Detonator. There were two handles and two acid-lead horns on upper half of the mine. The mine was laid in water, flat-bottom down, and if one of the horns was bent or crushed, an acid vial inside was borken, allowing the acid to drain onto two plates of a small battery which generated sufficient current to fire the detonator. As the wiring was series-parallel, either horn on being touched would act independently to fire the charge (pp 221-22, Fig 167)

Note: This mine is identical with Naval Anti-boat Mine described on p 185 of the book of Tantum & Hoffschmidt, listed here as Ref 7. It was believed that the mine was designed for anti-invasion purposes to be placed in shallow water against landing craft, vehicles and tanks Type JG Antiboat Land Mine, which existed in 5 modifications, each being actuated by a single chemical horn screwed into the top. The mines were either bell-shaped or of a truncated cone. Each contd 22 lbs of Type 98 Explosive. The mines were fired when chemical horns were broken (pp 222-23, Fig 168)

No Sea (Amphibian) Mines are described in

Ref 2, but the following *Navy Sea Mines* are described in Ref 1, Chapt III, under *Japanese Underwater Ordnance* (pp 34-53):

Contact Mines were generally spherical, with several lead, steel horns screwed into the mine case. Horns were of several types but the most common was a lead chemical horn, such as described above under Type JE Antiboat Land Mine. Some contact mines had a long copper wire antenna extending out of the top or bottom of the case. Should a steel ship touch the antenna while both were immersed in sea water, the mine would explode. Moored contact mines usually had some type of safety mechanism to render them inactive if they borke adrift, as well as devices to make sure the mines were safe while aboard the mine-laying ship, submarine, or plane (p 34)

Influence Sea Mines, were of various shapes, but usually they were cylindrical, like a bomb in appearance. They did not require contact with a ship in order to fire, and hence could be laid on the bottom many feet below the ship. Any physical change which took place in the water around the mine to the ship's passage over it could be utilized to actuate the firing mechanism. However, the most common types were magnetic and acoustic. Any mine without horns or antenna was almost certainly either an influence mine, or else a *Controlled Mine*, connected by an electric cable to the shore and fired by sending a current thru that cable (p 35)

Following is the list of Japanese Sea Mines used during WWII:

Type 88 Model 1 Contact Mine consisted of two light-metal hemispheres separated by a cylindrical belt and provided by four chemical horns on upper hemisphere. It was filled with 396 lbs of block-fitted Shimose. The depth setting hydrostat and mooring cable were provided (p 36, Fig 1)

Type 92 Moored Controlled Mine was ellipsoidal in shape, 55 by 41.5 inches, filled with 1100 lbs of Type 88 Explosive. The combined control and mooring cable entered the mine thru the base plate. An electric detonator and booster assembly were bolted to the chge underneath the top cover plate. A microphone to detect the presence of ships was also provided (p 36, Fig 2)

Type 92 Model 1 contd Type 1 Explosive and was without microphone (p 36, no Fig)

Type 93 Model 1 Moored Contact Mine was sphere-shaped 34 inches in diam and contd 220 lbs of Type 98 Explosive. Four chemical horns were located around the upper hemisphere, while the detonator was housed at the base (pp 36-7, Fig 3)

Type 93 Model 4 had six horns and was loaded with Type 1 Explosive (p 38, Fig 4)

Type 94 Model 2 was a ground controlled hemispherical mine with a base diam 28 inches and height 25 inches, contg 190 lbs of Type 88 Explosive. The firing cable entered the Booster and Detonator well thru the side of the case (pp 38-39, Fig 5)

Mark 5 Model 1 Moored Contact Mine had spherical case contg 180 lbs of Shimose. Four chemical horns were fitted to the upper hemisphere (p 39, Fig 5)

Mark 6 Model 1 Moored Contact Mine had spherical case, 41 inches in diam, contg 478 lbs of Shimose. Four chemical horns were set in the upper hemisphere (pp 39-40, Fig 7)

Mark 6 Model 3 contd 440 lbs of Type 88 Expl and was provided with six horns (p 40, no Fig)

Small Model Mine Model 1 was hemispherical in shape, 20 inches in base diam & 10 inches high which contd 45 lbs of Type 98 Expl.

Two chemical horns were located on the upper surface of the case. It was set on the ground in shallow water (pp 40-41, Fig 8)

Small Model Mine Model 2 was truncated cone-shaped case, 14 inches in base diam & 12 inches high, contg 22 lbs of Type 98 Expl. A single chemical horn was placed on top of the mine (p 41, Fig 10)

Type 3 Mark 1 Aircraft Mine Model 1 was cylinder 53 inches long and 24 inches diam, provided with a parachute and four chemical horns. It was filled with 240 lbs of Type 98 Explosive. The detonator and booster were located in a tube running transversely thru the mine case. It was dropped from an aircraft or surface moored (p 42, Figs 11 & 12)

Type 3 Model 2 Aircraft Mine Model 2 was an aircraft-laid *drifting* mine similar in appearance to fin-tailed bomb, 6 ft long and 14 inches in diam. It was filled with 123 lbs of Type 98 Expl cast in the spherical nose. The detonator and booster were housed in a transverse tube running thru the bomb, while further aft was

located the hydrostatic arming switch. The tail section broke free of the mine after laying and floated on the surface. The mine proper was suspended vertically ca 6 ft under the surface of water by a cable attached to the buoyant tail. When the tail was separated from the mine, three sensitive switch horns sprang out around the base of the suspended mine. About 5 lbs pressure on any of the horns could fire the mine (p 43, Figs 14 & 15)

Type 96 Mine was ellipsoid in shape and contd 120 lbs of Type 88 or Type 97 Expl. It was reported to be attached to antisubmarine nets. The firing mechanism of mine was of the tension type which detonated the mine when an enemy's submarine fouled a panel of the net (pp 44-45, Fig 16)

Banana Mine was the moored contact type provided with four chemical horns and loaded with 275 lbs of Type 88 Expl (pp 44-45, Fig 17)

JM Mine was moored, pear-shaped, contact mine which had no horns. The jolt received by the pendulum firing mechanism, when a ship struck the mine, closed an electrical contact and fired the detonator. The mine was filled with ca 110 lbs of a HE (?) (pp 44-45, Fig 18)

Pomegranate Mine was a Vickers antenna mine purchased before WWII. It was spherical, 41 inches in diam, with six chemical horns on the upper hemisphere and two addnl ones welded to the lower hemisphere. An upper antenna and float and/or lower antenna were secured to the mine. No data for HE filler (pp 44-45, Fig 19)

Type 3 Mine was the first Japanese attempt to use *influence* mines, copied from German S Mine. Their cylindrical Al cases were either 7 or 11 feet long and 21 inches in diam. No data for HE used and the description of the mine given in Ref 1, p 46 is hard to understand

Mark 2 Mod 1 Explosive Hook was actually a device for mine sweeping rather than a mine. It was a cylinder 8 inches in diam and 10 inches long, loaded with 33 lbs max of Type 88 Expl or Shimose. The device was towed underwater and when one of the four projecting arms welded to the body fouled a mine mooring cable, the device was electrically fired from the towing ship (pp 46-47, Fig 21 of Ref 1)

Addnl Ref on Mines: Ishikawa Seisakusho Co., Ltd, "Catalog of Various Types of Japanese Land and Amphibian Mines", (1955), Kanazawa, Japan

Minefield. Jirai fusetsu chitai

Minethrower. Hakugekihō

Mobile Artillery. Kidōshiki kahō

Molotov Cocktail (Tenage kaenbin). See under GRENADES

Monkan. Friction Primer

Mooring Line. Keiryūsaki

MORTARS (Kyūhō) and **SHELLS** (Dangan)

The following Mortars are described and illustrated in the book of Tantum & Hoffschmidt, listed as Ref 7:

70-mm Mortar Model 11 (1922) was a rifled bore weapon which fired HE, Smoke or Illuminating Shells, Range 1700 yds (p 159)

81-mm Mortar Model 3 was a smooth-bore weapon, forerunner of Mortar Model 97 (1937). It was manufd at Yokosuka Navy Arsenal. No data given for length of barrel and Shells used (p 162)

81-mm Mortar Model 99 (1939) was a short 25.5 inches), smooth-bore, muzzle-loading weapon of high trajectory. Used HE Shells. Range 3200 yds for 7.2-lb Shell (p 163)

81-mm Mortar Model 97 was similar to US 81-mm Mortar M1 with length of tube (including base cup) 49.5 inches. Fired HE Shells (p 165)

90-mm Mortar Model 94 (1934) was smooth-bore, muzzle-loading weapon with length of barrel (including base cup) 11.7 inches. Used HE or Incendiary Shells. Range ca 4050 yds with 11.9-lb Shell (p 167)

90-mm Mortar Model 97 (1937) was a Stokes-Brandt type weapon, very similar to US 81-mm Mortar M1. Length of barrel (interior) 48 inches, range 4050 yds for 11.8-lb HE or Incendiary Shells (p 168)

150-mm Mortar Model 97 (1937) was smooth-bore muzzle-loading weapon with length of tube (internal) 66 inches. No data for its range and shells used are given (p 169)

There were also two Grenade Dischargers which resembled Mortars in appearance:

50-mm Grenade Discharger Model 10 (1921) consisted of a steel smooth-bore barrel 9.5

inches long attached to a pedestal resting on a base plate. It was muzzle-loaded and was fired by a continuous pull firing mechanism, operated by a lever on the outside of discharger body. Used for firing 91 Hand Grenade, Pyrotechnic Signals and Smoke Shells (p 155) 50-mm Grenade Discharger Model 89 (1929) had steel rifled-bore barrel 10 inches long attached to a pedestal, resting on a base plate. The propellant chge was placed at the bottom of barrel, held at 45 degree angle, and this was followed by projectile inserted thru muzzle (with safeties removed). Then the trigger which protruded thru a lengthwise slot in the pedestal was pulled and fired the proplnt. It was used for firing Model 89 HE Shell, Model 91 Hand Grenade, Model 95 Smoke Shell and Incendiary Shell. Range 700 yds for shell, 200 for Grenade (p 156 of Ref 7)

32-cm (320-mm) Spigot Mortar. The spigot shown in Fig on p 170 of Ref 7 was a cylinder 31.7 inches long with outside diam 10.1 inches. A cavity was machined in its upper end for the propelling charge. In the bottom of the cavity there was a threaded recess for the igniter assembly. An igniter train hole passed from it to the base of spigot. The steel mounting plate in the shape of a dome was attached to a steel base plate which rested on three layers of heavy wooden beams

Accdg to Ref 3, pp 389-90, the Shell fired by Spigot Mortar was cylindrical in shape (resembling a bomb) with ogival nose and finned tail section hollowed out to inside diam of 10.12 inches and length 14.5 inches so that it could fit over the spigot. The shell contd 103 lbs of Shimose as main chge and PETN as booster. Its Fuze was Type 98. The propellant chge - single-base with BkPdr as Igniter was placed in a brass pot which fitted into the recessed portion of the spigot tube. The chge was contd in a cardboard container having a flash tube passing thru its vertical axis, thru the brass pot and screwed into the spigot. Also there was a drilled and tapped hole near the forward end of the tail section of the shell into which the igniter tube screwed. When in position, the igniter tube was in close proximity to the end of the brass flash tube which led into the proplnt chge. Variations in range could be obtd by varying the number of in-

crements selected for the proplnt chge

The following Shells for use in Army and Navy Mortars are described in Ref 3:

Type 89 58-mm HE Mortar Shell was a light steel cylinder with conical nose housing a Fuze. It was filled with 5.4 oz of TNT and it was fired by NC-DPhA flaked proplnt fired from Type 89 Grenade Discharger (pp 272-73, Fig 296)

Type 95 50-mm Smoke Mortar Shell was a forged steel cylinder with conical nose housing a Fuze. It contd 3.7 oz Hexachloroethane Smoke Mixture and was fired by NC-DPhA flaked proplnt. Fired from Type 89 Grenade Discharger (pp 374-75, Fig 297)

Type 89 50-mm Incendiary Mortar Shell was a sheet metal cylinder with hemispherical nose. It contd 10.7 oz of Incendiary Mixture and its base was NC proplnt and two BkPdr delays. Fired from Type 89 Grenade Discharger (pp 375-76, Fig 298)

Type 11-Year 70-mm HE Mortar Shell was a light steel cylinder with conical nose housing a Fuze. Its Main Charge was 15.2 oz TNT with Booster 1.6 oz of PA. Was fired by NC-DPhA flaked proplnt. Fired from Type 11-Year 70-mm Rifled Mortar (p 378, Fig 301)

70-mm HE-AA Barrage Mortar Shell consisted of a light-steel outer shell contg 7 canisters in each of which was an HE cylinder and parachute. A turned steel base was welded to the outer shell, and provision was made for reception of a delay train holder, a shell proplnt container, and an end cover. The delay train led to a Bk-Pdr chge which ejected the canisters from the shell. Total wt of Main chge 12.84g of RDX, with Booster of LA (Lead Azide)

We are not describing the construction of this shell in detail because it is very complicated and requires detailed illustrations. It suffices to say that the Shell was fired by dropping it into a smooth-bore Mortar, 4 feet long, attached to a base plate, a rectangular wooden block and an iron rod which was stuck into the ground to hold the Mortar upright. This weapon, known as 70-mm AA Barrage Mortar, was fired at the time of approach of low-flying enemy aircraft so that it released from each shell 16 parachute-provided cylinders which were suspended in the air forming a kind of barrage. Seven of these cylinders contd HE chge of RDX-LA which was connected to a

friction cap attached to parachute cord. Any enemy plane touching a parachute cord of any of the seven HE cylinders would cause an explosion (Ref 3, pp 178-80, Fig 302 and Ref 7, pp 160-61)

Type 97 and Type 100 81-mm HE Mortar Shells were in the shape of streamlined bombs. Its Main Charge was TNT (ca 1.2 lbs), Booster-PA and proplnt which is described here under PROPELLANTS. Was fired from Type 97 or 99 Mortars (pp 380-81, Figs 303 & 304)

81-mm Parachute HE Mortar Shell was cylindrical in shape. Its Main Charge was RDX (one block) and TNT (two blocks) - total wt 4 oz. Its primer, ejection and delay charges were BkPdrs, but no data for its propellant are given. Was fired from 81-mm Smooth Bore Mortars (pp 381-82, Fig 305)

81-mm Parachute HE Smoke Mortar Shell was similar in construction to HE Shell, except that its Main Charge was Tetryl and it contd a smoke pellet (?) (pp 383-84, Fig 306)

81-mm Parachute-Flare Mortar Shell was cylindrical, similar to 81-mm HE Mortar Shell, except that it contd a flare compn for which no data were given (pp 384-85, Fig 307)

Type 94 HE and HE Semisteel Mortar Shells were in the shape of streamlined bombs. Their Main Charge was TNT (2.35 lbs), with pressed PA as Booster. Compn of proplnt not given. Was fired from Type 94 or 97 90-mm Mortars (pp 385-86, Figs 308 & 309)

Type 94 90-mm Incendiary Mortar Shell was similar to Type 94 HE, except that it contd Incendiary filling consisting of WP, CS₂ & 40 cylindrical rubber pellets (2.2 lbs). It also contd Burster Chge and Proplnt of unknown compn (pp 386-87, Fig 310)

Type 2 120-mm HE Mortar Shell was streamlined in shape, contg 6.0 lbs of TNT with RDX/Wax Booster. No data for proplnt. Was fired from Type 2 120-mm Smooth Bore Mortar (pp 387-88, Fig 311)

Type 96 150-mm HE Mortar Shell was streamlined in appearance contg 12.9 lbs of TNT as Main Charge with PA as Booster. Compn of proplnt is given under PROPELLANTS. Was fired from Type 96 150-mm Smooth-Bore Mortar (p 388, Fig 312)

Type 97 150-mm HE Mortar Shell was a shorter version of Type 96. It contd 9.98 lbs of TNT

and RDX/Wax Booster. Its proplnt was the same as for Type 96 (pp 388–89, Fig 313) 32-cm Spigot Type Mortar Shell is described under 32-cm (320-mm) Spigot Mortar

Mountain Artillery. Sampōhei

Muenkayaku or Muenyaku. Smokeless Propellant. See under PROPELLANTS

Munitions. Gunjuhin

Mustard Gas. Masūtado gasu; Iperitto gasu

Muzzle. Hōko (Arty); Jūkō (Small Arms)

Muzzle-Loader. Zensōhō

Muzzle Velocity. Shosoku

Naval. Kaigan no

Navigation Markers. See under Markers and Indicators

Navy. Kaigun

Nigotanoyaku-Mk 2. Pale-yel or cream expl mixts of TNT & RDX (70/30, 60/40 & 50/50). Its 50/50 Compn is called in Ref 2, p 30 "Army Mk 2 Explosive" or **Tanōyaku**, but accdg to Ref 5, p 373, Tanōyaku contd TNT, RDX & 7–10% Tetryl. Accdg to Ref 5, p 368, the 50/50 version was called *Chauyaku*

Nigotanyaku expls were used in many types of Army Ordnance (Ref 1, p 27). Accdg to Ref 5, p 368, they were used in Bombs, Shells, Land Mines and Bangalore Torpedoes. The 53/47–TNT/RDX version was used in Demolition Charges

Nitoroguriserin muenyaku. Nitroglycerol or Double-Base Propellants. See under PROPELLANTS

Nitrocelluloses (Shōkamen), such as described in Vol 2 of Encycl under CELLULOSE, were used in NC Propellants (Shōkayaku) or Single-Base Proplnts. See under PROPELLANTS

Nitrocotton. Menkayaku

Nitroglycerol (Nitoroguriserin). Described in Vol 6 of Encycl, under GLYCEROL TRINITRATE, pp G98ff. It was used in Dynamites (See under Dainamaito) and in Double-Base Propellants (See under PROPELLANTS)

Nose (of Projectile). Dantō

Nose Fuze. Dantō shinkan

Obturation. Kinsoku

Offensive. Kosei

Onayaku. A yellow, castable expl compn consisting of PA (Picric Acid) 50 & DNN (Dinitronaphthalene) 50%, which melts below 120°. Its Brisance, Power and Rate of Detonation were lower than those for straight PA and it was less sensitive to Impact than PA. Used as Bursting Charge in Artillery Projectiles, such as in 7-cm (75-mm) HE-AA Proj, listed in Ref 3, p 318

There was also, accdg to documents, mixture of PA 80 & DNN 20% which was identical with *Frantsuzskaya Smes'* used by the Russians (Ref 1, p 26 & Ref 5, p 368)

Oshitsuyaku. Accdg to Ref 5, pp 367 & 368, it is identical with *Koshitsu* (qv)

Ōshiyaku. A yel, press-loaded expl compn consisting of PA 90 & wax 10%. It was much less sensitive to Impact & Friction than straight PA and had lower Brisance, Power and Rate of Detonation. It was used as Bursting Charge in nose of some Armor-Piercing Projs, such as Type 95 7-cm (70-mm) AP Proj listed in Ref 3, p 309 (See also Ref 1, p 26 & Ref 5, p 368)

Oshokuyaku (Army), **Shimose bakuyaku** (Navy) or **Pikurisan**. Picric Acid (PA), $\text{HO.C}_6\text{H}_2(\text{NO}_2)_3$; mw 229.11, N 18.34%; yel crystals, density 1.76, mp 122°, Brisance by Sand Test 113% TNT; Explosion Temp 320° (decomp); Power by Ballistic Mortar 112% TNT; Rate of Detonation 7350m/sec for cast (Shimose) vs 6900 for TNT; Impact Sensitivity by BurMinesApp with 2-kg weight 85cm vs 100 for TNT [AMCP 706-177 (1971), p 288]. Used by the Japanese Army as a press-loaded Booster Charge in Bombs, Shells, Mines and Standard Demolition Charges. Used

cast, under the name of Shimose, as Bursting Charge in some Bombs, Shells, Torpedoes & Mines. Also used in some expl compns, such as *Chaōyaku*, *Onayaku* & *Oshiyaku* (Ref 1, pp 25, 26 & 31 and Ref 5, p 369)

Otsu-B, Type A or A (ko) Explosive. A dark green expl compn of TNT 60, HNDPhA (Hexanitrodiphenylamine) 24 & Al pdr 16%. Used by the Navy for loading Torpedo Warheads, Sea Mines and Depth Charges. It was identical with German expl compn *Schiesswolle 18 oder TSMVI-101*, described in PATR 2510 (1958), p Ger 177-L (See also Ref 1, p 32 & Ref 5, p 361, under A (ko) Explosive)

Paper Balloons. See Balloons, Paper

Parachute Flare (Chōkō shōmeidan). See under FLARES.

Penetration (of Projectile). Shintetsu

Pentolite. See Pentoriru

Pentoriru (Pentolite). A pale yel or cream expl compn of PETN (Pentaerythritol Tetranitrate) 50, coated with TNT 50%, density 1.65, Brisance by Sand Test 125% TNT, Explosion Temp – decomposes at 220° in 5 secs; Power by Ballistic Mortar 126% TNT, Impact Sensitivity by BurMinesApp with 2-kg wt 34 cm vs. 100 for TNT; Rate of Detonation for cast 7465m/sec vs 6900 for TNT [AMCP 706-177 (1971), p 272]. Used in Navy 20 & 30-mm Projs (Ref 1, p 33) and in some Shaped Charges (Ref 5, p 369) (See also Ref 3, p 441)

PETN (Pentaerythritol Tetranitrate). See Shoeyaku

Picric Acid (PA) (Pikurinsan). See Oshokuyaku (Army) and Shimose Bakuyaku (Navy)

Pikurinsan Ammonia (Ammonium Picrate) is described as Explosive D in AMCP 706-177 (1971), p 136, $(O_2N)_3C_6H_2.ONH_4$; mw 246.24, N 22.76%; yel crystals, d 1.72, mp–decomp at 265°; Brisance by Sand Test ca 92% TNT; Explosion Temp, decomp in 5 secs at 318°; Impact Sensitivity BurMinesApp, 2-kg Wt > 100cm;

Power by Ballistic Mortar 99% TNT; Rate of Detonation 6850m/s vs 6900 for TNT. Used in composite expls: Type 1, Type 1 Mk SP5, Type 1 Mk 6 and others (Ref 5, p 369)

Point Detonating Fuze. Dantōbakkan; Dantō shinkanen

Powder (Kayaku; Bakuyaku). See PROPELLANTS

Powder Bag. Yakunō

Powder Charge. Sōyaku

Powder Train. Dōkasen

Primer. Bakkan

Primer Charge. Kibakusai

Projectile (Dangan; Shadan). See under AMMUNITION

PROPELLANTS (Hōshayaku).

There were 1) **Smoke Propellants** (or *Non-smokeless Propellants*), called *Yuenyaku*, which were *Black Powder* called *Kokushokuyaku* (Ref 1, p 27) and *Brown Powder* called *Kasshokuyaku* (Ref 1, p 30). They are described here under K's and 2) **Smokeless Propellants** of general term *Muenkayaku* or *Muenyaku*.

The following **Smokeless Propellants** were used by the Japanese:
A) **Nitrocellulose or Single-Base Propellants** (Shōkayaku) contd NC (Nitrocellulose) (ca 12.5% N) 98 & DPhA (Diphenylamine) 2%. Used to propel many projectiles (Ref 1, p 30). A slightly different formulation is given on p 33 of Ref 1: NC 98.0, DPhA 0.8, DNT 0.95 & graphite 0.25%

Single-base proplnts were subdivided accdg to shape and sizes of grains into Mk 1 (squares of flat strips); Mk2 (squares); Mk3 (strips); Mk 4 (strips) and Mk 5 (strips) (Ref 3, pp 346 & 357). There were also graphited proplnts made of single-perforated cylinders. They were used in Types 97 & 98 20-mm Ammunition (Ref 3, p 280)

B) **Double-Base (NC-NG) Propellants** included:
a) NC 67.8, NG 29.3, DPhA 0.7 & NaCl 2.2%.

Used for propelling some Mortar Projectiles (Ref 1, p 30)

b) NC 65.6, NG 29.2, Ethyl Centralite 3.7 & NaCl 1.5%. Used for propelling many Artillery Shells (Ref 1, p 33)

c) NC 60.0, NG 34.5, Ethyl Centralite 3.0 & Diphenylformamide 2.5%. Used to propel Type 1 47-mm HE & AP Shells (Ref 3, pp 298-99)

d) Smokeless Double-Base Propellant B analyzed in US: NC 63.50, NG 27.71, Ethyl Centralite 3.8, Diphenylformamide 3.68, volatiles 1.30, graphite 0.45 and ash 0.34%. Consisted of single perforated cylinders of various lengths for use in 20-cm HE Spin-Stabilized Rockets (Ref 3, p 372)

e) NC & graphite 58.0, NG 7.1, DNT 25.7, DPhA 0.5 & K nitrate 8.7%. Used to propel Type 97 81-mm HE Mortar Shell (Ref 3, p 380), Type 96 & 97 150-mm HE Mortar Shells (Ref 3, pp 388 & 389)

f) Propellant for "Baka" Rocket Bomb: NC 59.9, NG 26.9, MNN (Mononitronaphthalene) 6.1, EtCentralite 2.9 & volatiles 1.3% (Ref 2, p 118)

g) Special DT6 Double-Base Propellant: NC 60.0, NG 29.3, EtCentralite 2.85 & MNN (Mononitronaphthalene) 6.14% consisted of single-perforated grains. Was used to propel 12-cm Incendiary-Shrapnel Rocket (Ref 3, p 514), 20-cm HE Rocket (Ref 3, p 515) and 45-cm HE Rocket (Ref 3, p 516)

Proving Ground. Shiken shagekijō

Proximity Bomb, Type 5 No 25 Mk 33 is described in Ref 2, p 93, Fig 70 on p 92

Pyrotechnic Pistol. Shingō kenjū

Pyrotechnics. Shingōdan

Pyrotechnic Signal. Kasen shingō

Quickmatch. Kyūnen kasaku

Raibun (Enka) (Thunder Powder or Smoke and Fire) consisted of K chlorate 60 & Arsenic Sulfide 40%. Lt gray to tan powder used in fuze and pyrotechnic primers. Comp with *Bakufun* (Ref 1, p 25; Ref 5, p 369, where its compn is erroneously given as K chlorate 60 & Antimony sulfide 40%)

Raigeki suru. Torpedo

Raikan, Percussion Primer or Cap

Raikō (Army) or **Raisansuigin** (Navy) "Thunder Mercury". *Mercuric Fulminate*, $\text{Hg}(\text{ONC})_2$; mw 284.65, N 9.84%; white to gray pdr, d 4.43, mp--decomp or detonates without melting; Brisance by Sand Test--ca 55% TNT; Expln Temp 210° in 5 secs; Impact Sensitivity, BurMinesApp, 2-kg wt--5cm; Power by Trauzl Test--51% TNT; Rate of Deton 5000 at d 4.0 (AMCP 706-177, listed as Ref 8, p 201). Used straight by the Japanese in Instantaneous Fuzes, in Blasting Caps and in mixture called *Bakufun* (Ref 1, p 25 & Ref 5, p 369)

Rakkasan. Parachute

Range (of Weapon). Shatei

Recoil. Handō suru or Kōza sura

Relay. Denkeiki

Rempatsujū. Magazine Rifle or Repeating Rifle

Rentaihō. Regimental Cannon

Report (Explosion). Bakusei

Resshahōhei. Railway Artillery

Ricochet. Chōdan

Rifle. Shōjū

Rifle Grenade. Jūyō tekidan

Rikugun. Army, Land Forces

Rin. Phosphorus

ROCKET (or *Roketto*) (*Funshindan*) or **Rocket Ammunition** *Raketto Danyaku*) can be defined as any self-propelled, unguided missile which is fired from a device called a *launcher*, as was Ger Faustpatrone, Russian Katiusha or Amer Bazooka. Japanese launchers are briefly described here under **ROCKET LAUNCHERS**. Each Rocket Missile carried its own propeller

type motor (described here under Rocket Motors) and a warhead contg an HE, Incendiary or Chemical Agent (Vol 1 of Encycl, p A384-R) (See also ROCKETS)

ROCKET BOMBS (Roketto bakudan).

The following Navy Rocket Bombs are listed in Ref 2:

Type 5 No 1 Mk 9 Model 1 and Type 3 No 6 Mk 9 Bombs were fin stabilized and closely resembled American Aircraft-launched Rockets. Both carried HE Fillers and small charges of Propellant (p 71 of Ref 2; no Fig)

Type 3 No 6 Mk 27 Rocket Bomb Model 1 was fin-stabilized, aircraft-launched, designed for use against formations of large enemy planes. It was cylindrical in shape with conical nose section which contd a Fuze, a Burster Charge and an Incendiary Shrapnel, consisting of WP (White Phosphorus) filled steel pellets. Its cylindrical part contd Ballistite type Propellant in grains 350mm long and 19.2mm in diam. Its tail section was constricted to form a venturi for the escape of driving gases. This Rocket, along with Type 3 No 1 Mk 28 Model 1, was the only Navy Rocket which was actually under production at the end of WWII (p 84 & Fig 65 on p 85)

Type 3 No 1 Mk 28 Rocket Bomb Model 1 was to a certain degree similar to Type 3 No 6, except that it contd HE Filler instead of Incendiary (pp 86-87, Fig 66)

"Baka" Piloted Rocket Bomb was a suicide weapon designed to be controlled by a human pilot. It resembled a plane, was carried beneath the fuselage of a bomber and released near its target. Three Type 4 Mk 1 Rocket Motors provided propulsion after "Baka" was released from the mother plane. The entire HE content of the "Baka" (1135 lbs of Type 91 Expl) (Trinitroanisole) was in the warhead of the nose. "Baka" was 19 ft 10 inches long with wingspread 16 ft 5 inches. Its warhead had Nose and Tail Fuzes (pp 116-17, Fig 88)

Type 4 Mk 1 Launching Rocket ("Baka" Motor) was cylindrical in shape with conical nose and venturi tube tail. It contd 97.8 lbs double-base proplnt of compn listed under PROPELLANTS, item f. Three of such devices, located in fuselage of "Baka", served as the main propulsion units (Ref 2, p 118, Fig 89)

ROCKET LAUNCHERS and PROJECTORS (Roketto Hasshaki).

Accdg to Refs I & R, Japanese Rocket Launchers were mostly wooden troughs, others were guide rails and steel barrels (tubes). Launchers were provided with some electric ignition device. The most practical launcher was used by the Japanese Army under the name: Type 4 20-cm Rocket Launcher, described in Ref 1, p 204 and shown in Fig 320 on p 206. It consisted of a metal tube on a mounting permitting fine adjustments in elevation and train. The launcher was in three parts which could easily be disassembled for transportation. A rate of fire of from 1 to 2 rounds per minute could be obtd

Other launchers listed and illustrated in Ref 1 were:

20-cm Rocket Launcher consisting of a wooden trough, 7 feet long, held in an inclined position by a bipod (p 205 & Fig 329 on p 209)

20-cm Rocket Launcher consisted of a steel barrel (tube) mounted on 10-ft wheels (p 205 & Fig 330 on p 209)

45-cm Rocket consisting of a wooden trough mounted on wheels. Was good for one shot only (p 205 & Fig 331 on p 209)

Special Mark 1 Model 21 Launcher for 250-kg Rocket Bomb consisted of a wooden trough 22 feet long (p 25)

12-cm Incendiary Shrapnel Rocket Launcher consisted of a wooden trough installed fore and aft on "Suicide Boats" (qv). Later models were adjustable in elevation (p 25)

In the book of Tantom & Hoffschmidt (Ref 8), the following Rocket Launchers and Rocket Projectiles are described and illustrated: 20-cm Rocket Projectile and Launcher (p 171). The ground-launched Rocket, 21.05cm in diam, described here under ROCKETS was fired from a trough-shaped launcher ca 7 ft long, which weighed ca 175 lbs. Range of 1970 yds at 50 degree elevation was claimed (See also Ref 1, p 205)

Rocket Launcher and Rocket Motor Model 10 (p 172) was designed to propel the 60-kg aircraft bomb out of an inclined trough. The launcher was constructed of wood and metal with legs made of iron pikes. The launcher channel was a right angle wooden trough, ca 20 ft long with a motor and bomb positioner

made of 1/8-inch pierced sheet metal. The rear of launcher was attached by a pin to a base plate. Elevation was controlled by cables run from the base plate to the legs, and between them

The Rocket Motor resembled a blunt short-bodied, fin-stabilized, bomb provided with a venturi tube at its rear. The propellant (12.94 lbs) which consisted of three cylindrical sticks tied in a silk bag, was in a cylindrical container located above the venturi tube. The charge was ignited by an Igniter Pad and an Igniter Fuze in the forward part of the motor by means of wires leading to a small Hand Blasting Machine. When fired the motor propelled the Rocket from the launcher and then dropped off. Ranges up to 1300 yds were claimed, but accuracy was very poor

These devices are described in Ref 2, pp 120–21, Fig 91), under the title "Type 3 and Model 10 Bomb Launching Devices". The description includes the compn of proplnt used in Rocket Mortar as: NC 65, NG 30, Et Centralite 3.0 & NaCl 2.0%. It was code-designated by the Japanese as "343 DT₂" and was ignited by an electric squib

Rocket Motors (Roketto Hashhaki) are devices designed to provide propulsive power (propel or launch) to a Bomb or Rocket Projectile of an inclined trough or barrel called *Launchers*

One of such Rocket Motors is described and illustrated in the book of Tatum & Hoffschmidt (Ref 7, p 172) under the title "Rocket Launcher and Rocket Motor Model 10". It is briefly described here under Rocket Launchers. They are also described in Ref 2, pp 120–1

Another Rocket Mortar (Type 4 Mk 1) is described here under ROCKET BOMBS as a device used to propel "Baka" Piloted Rocket Bomb (Ref 2, p 118)

There was also "Special Mk 1 Rocket Motor Model 21" which consisted of a cylinder 80.3 inches long & 11.8 inches in diam with rounded nose and a venturi tube attached at the rear. This unit was designed as an integral type bomb pusher for launching 250-kg Bombs from ground launchers for land bombardment. Its motor weighed 429.2 lbs, while wt of proplnt was 178.2 lbs, consisting of 20 sticks of "343 Special DT₂" which contd NC 65, NG 30, Et Centralite 3.0 & NaCl 2.0%. It was ignited by

Electric Igniter with BkPdr charge. The unit was launched from a crude wooden trough mounted on a bipod forward and a steel base plate aft (Ref 2, pp 119–20, Fig 90)

ROCKETS (Roketto) or ROCKET PROJECTILES (Roketto Dangan)

Japanese Rockets are subdivided into Army Rockets (Ref 1, p 204 & Ref 3, pp 371–72) and Navy Rockets (Ref 1, pp 204–05 & Ref 3, pp 514–16)

The following Rockets are described with illustrations:

Type 4 20-cm Army Rocket was spin-stabilized, cylindrical in shape, 37 inches long, (including ogive nose) weighing 180 lbs and contg HE charge of TNT and Ballistite as propellant (Ref 1, p 204) 20-cm HE Army Spin-Stabilized Rocket, cylindrical in shape, 38.58 inches long (including ogive nose), weighing 186.3 lbs and contg cast TNT as HE Filler and Smokeless Double-Base Powder B, described here as item d, under Propellants (Ref 3, pp 371–72)

Note: This Rocket seems to be identical with the one described in Ref 1, p 204 Navy Rockets were HE (two kinds) and Incendiary (one kind). They are listed in Ref 1, pp 204–05, but not described. The following are described in Ref 3:

12-cm Incendiary-Shrapnel Spin-Stabilized Rocket was cylindrical in shape with ogive nose, overall length ca 28.5 inches, weight 51 lbs, which included Fuze, 4.75 oz PA burster charge, 10 lbs 10.75 oz of Incendiary cylinder contg WP pellets, 7 lbs 5 oz Special DT6 Propellant (listed as item g under PROPELLANTS) and Ignition Mechanism. It was launched from a wooden trough mounted one on each side of the cockpit of a Suicide Boat (qv) (Ref 3, p 514, Fig 423)

20-cm HE Spin-Stabilized Rocket had an artillery-projectile shape body, overall length (w/o Fuze) 40.28 inches, weight ca 200 lbs, which included: Fuze 38.58 lbs cast Type 91 Expl (TNAns), Fuze, Propellant (18.3 lb) Special DT2 (no data) or Special DT6 (listed as item g under PROPELLANTS) and Ignition Mechanism. Three signal-round launchers were designed for this Rocket. Two of them were trough-type, while the 3rd was a barrel type launcher. In addn a triple-mount trough was used (Ref 3,

p 515, Fig 424). Same Rocket is described in Ref 8, p 171
 45-cm HE Spin-Stabilized Rocket was cylindrical in shape with conical nose, length (w/o Fuze) 67.5 inches, weight 1514 lbs, which included 401.0 lbs of Type 98 Expl (PA), 131.5 lbs Special DT6 Propnt (listed as item g under PROPELLANTS) and Ignition system. A crude wooden-type launcher was used with this Rocket (Ref 3, p 516, Fig 425)

Roketto. See ROCKETS

Roketto-shiki tekidan. Antitank (A/Tk) Rocket

Ryūdampō. Howitzer

Ryūsandan. Shrapnel Shell

SABOTAGE DEVICES (Bōgyō sōchi; Hasai bōryaku).

Under this term may be included any item intended to produce malicious injury to people, machinery, tools, etc; practiced mostly during the wars

The following Japanese Sabotage Devices are described in Ref 2, pp 258–63:

Explosive Toothpaste consisted of a toothpaste tube filled with 4.23 oz of a mixture of RDX 80.2 & mineral oil with wax 19.8% and provided with an Igniter (p 258, Fig 195)

Explosive Coal consisted of thin earthenware containers of irregular shape coated with a bituminous type paint. Each piece was filled with RDX and contd an Igniter with Detonator and a small chge of BkPdr. When exposed to fire the heat eventually ignited the BkPdr chge, which in turn set off the Detonator and RDX (p 259, Fig 196)

Explosive Food Cans consisted of regular tin cans with American labels such as "Libby's Strawberries". They contd 1.37 lbs of a mixt of RDX 78.3 & mineral oil 21.7% and were provided with an Igniter, Delay and Detonator (pp 260–61, Fig 197)

Metal Incendiary Cylinders were 6¼ inches long and 2¾ inches in diam filled with Thermit (Incendiary) and provided with two Igniters, Delay and First Fire Charge consisting of $KClO_3$, Sb_2S_3 & Al pdr (pp 261–62, Fig 198)

Incendiary Brick consists of an incendiary mix-

ture of K chlorate, sulfur, ground coal (or sugar), iron filings and wax compressed in the shape of a regular US brick. It was coated with paint to give it the appearance of a glazed brick. As there was no Igniter, one of the methods used to ignite the brick was to place some K permanganate on top of it and pour concd sulfuric acid over it (p 262, Fig 199)

Incendiary Soap consisted of a mixture of Ba nitrate 30.4, paraffin 19.4, Mg 11.3, Al 11.1, rosin 10.9, ferroso-ferric oxide 9.1, NC 4.4 & gritty siliceous material 2.6%, compressed into a regular soap bar. Its method of ignition by the Japanese is not known

Following items which are actually Sabotage Devices are described in Ref 1, pp 231–32:

Sucker Traps were devices set in living quarters, abandoned equipment, etc, mainly for the purpose of lowering the enemy's morale. Besides the various Booby Traps described here under MINES, the following items were used by the Japanese:

Explosive Radio, contd HE charge occupying the space obtd after removing all batteries except one. When the switch was turned on, the electric circuit closed (p 231, Fig 377)

Explosive Phonograph. An electric contact on the pick-up was so arranged that sufficient movement of the arm to play a record would close the circuit and set off the charge of explosive concealed with battery under floor-board (p 231, Fig 378)

Explosive Telephone. A pull-igniter fitted to an expl chge was placed inside a telephone. The line from the igniter was secured to the crank of the telephone so that an attempt to ring would set off the charge (p 232, Fig 379)

"Tin Can" Booby Trap consisted of a regular American tin can which was filled with expl chge and provided with a friction pull igniter and trip wire (p 232, Fig 380)

Safety Fuze. Dōkasaku

Safety Pin. Anzensen

Sairetsu teryūdan. Fragmentation Grenade

Sairetsu tōka bakudan. Fragmentation Bomb

Sakuma Dainamaito. One of the Japan Dynamites

Sakura No 1 & No 2. Blasting Gelatin

Sakuretsu. Burst, Explosion

Sakuyaku. Bursting Charge

Sampōhei. Mountain Artillery

Sandanjū. Shotgun

Sanshōki mechiru nitroamin (Tetryl). See Meiyaku

Sanshoki toruoru or Type 92. See Chakatsuyaku

Seacoast Artillery. Kaiganho

Sea Markers. See under Smoke Floats and under Markers and Indicators

Seigata (Army), Type 97H (Navy) (German Hexamit). A lt yel to orn, castable expl mixture of TNT 60 & HNDPhA (Hexanitrodiphenylamine) 40%. Density 1.65 (cast), Brisance by Cu cylinder crusher test 96% of PA; Expln Temp 302°+; Impact Sensitivity, 14cm max for no explns with 5-kg wt; Power by Ballistic Mortar 92% PA; Rate of Deton 7100m/s vs 6900 for TNT. It was used at the beginning of WWII for loading some Torpedo Warheads, but later replaced by A(ko) (Type A Expl); was also used in some Depth Charges and Navy Rockets (Ref 1, p 32 & Ref 5, p 370)

Self-Propelled Guns. All guns mounted on combat vehicles may be considered Self-Propelled Guns. These vehicles include Tankettes (Ref 8, pp 117–19), Tanks (p 120–29) and Armored Cars (pp 132–35). Only one of these is listed as “self-propelled”. It is *150-mm Self-Propelled Howitzer, Type 38 Year (1905)* which is mounted on medium tank chassis. Its detailed description and illustration are given on p 129 of Ref 8

Semisteel Bomb. Koseisen bakudan

Senshahō. Tank Gun

Sensō. War

Sensuikan. Submarine

Sentei. Groove, Rifling

Sentō. Battle, Combat

Sentō bakugekiki. Fighter Bomber

Sentōkan. Battleship

Shadan. Projectile

Shakunetsuzai (Thermite). An incendiary mixture of Al & Fe₃O₄, which can be ignited by Mg. Used in admixture with BkPdr or HE's for loading some incendiary items of Ammunition, while the majority of such items contd WP (White Phosphorus)

Following incendiary items contd Thermite:
1-kg and 5-kg Thermite Incendiary Bombs (Ref 2, p 15)
Type 98 No 7 Mk 6 Model 1 Incendiary Bomb (Ref 2, p 71)
Metal Incendiary Cylinders, used as a Sabotage Device (Ref 2, p 261)

Shakyori. Range

Shaped Charge. See Hollow Charge [Ta(dan)]

Shell. Hōdan

Shikan. Adapter

Shimose Bakuyaku (Navy) or Ōshokuyaku (Army)

Shingōdan. Pyrotechnics

Shingō kasen. Signal Rocket

Shingō kenjū. Signal Pistol, Véry Pistol

Shinkan. Fuze

Shinkan kibakuzai. Fuze Detonator

Shin-kiri or Shinkyoryoki. Gelatin Dynamite

Shinkō. Cavity (of Projectile)

Shinshoku. Erosion, Corrosion

Shintetsu. Penetration (of Projectile)

Shin-toku shoan. Ammonium Nitrate Dynamite

Shiraume. Gelatin Dynamite

Shoan bakuyaku. An AN (Ammonium Nitrate) explosive compn used in Army Substitute Demolition Charges: AN 79, DNN (Dinitronaphthalene) 10, sawdust 1 & NaCl 10%. TNT could replace DNN (Ref 1, p 29 & Ref 5, p 371)

Shoanbakuyaku Nos 104 & 201. Ammonium Nitrate Dynamite

Shoanyaku. A series of coal-mining expls manufactured at the Uji Factory (Kyoto Prefecture):

No 1. AN 70, DNN 9, woodmeal 1 & NaCl 20%

No 2. Same as Shoan bakuyaku (See previous item)

No 5. AN 64, TNT 12, woodmeal 3, wheat starch 1 & NaCl 13%

No 7. AN 75, DNN 9, TNT 1.5, woodmeal 1.5 & NaCl 13%

Special: AN 64, DNN 3, TNT 7, GuN (Guanidine Nitrate) 2, Na nitrate 2, woodmeal 2 & NaCl 20%

These expls were reported to have Impact Test Value with 2-kg Weight ca 80cm and Gap Test Values 100 to 150mm. Some of the mixtures were used for military purposes (Ref 5, p 371)

Shōbenyaku. See Anbenyaku

Shoeyaku. Pentaerythritol Tetranitrate (PETN), $C(CH_2ONO_2)_4$; mw 316.14, N 17.72%; wh crystals, d 1.77, mp 141°; Brisance by Plate Dent Test 129% TNT; Explosion Temperature 225° (decomp in 5 secs); Impact Sensitivity BurMinesApp, 2-kg Wt 17cm (vs 100+ for TNT); Power by Ballistic Mortar Test 145% TNT; Rate of Detonation 8300m/sec (Ref 8, p 276). Pressed PETN was used in Army 7.7 & 12.7-mm Fuzeless Projectiles and 20-mm MG Projs. Also in Boosters. Its mixt with TNT is called *Pentoriru* (qv). PETN with 8.5% wax was used for loading 20-mm Shells. Its mixtures with RDX were used in 7.7 & 12.7-mm Projectiles. PETN was also used in Incendiary Mixtures (Ref 1, p 27 & Ref 5, p 372)

Shōgeki. Impact; Shock

Shōgeki shinkan. Impact Fuze

Shōidan. Incendiary Shell

Shōiyo bakudan. Incendiary Bomb

Shōiyo tekidan. Incendiary Grenade

Shōjū. Rifle

Shokaki. Small Arms

Shokamen. Nitrocellulose (NC)

Shokayaku (Nitrocellulose Propellant). See under PROPELLANTS

Shokuhatsu jirai. Contact Mine

Shomeidan. Illuminating Shell; Parachute Flare

Shonayaku. Yel-brn expl mixture of AN 90 & DNN 10% used for loading cast semisteel Shells, Land Mines and Demolition Charges. It was suitable for tunnel work because it did not give toxic fumes (Ref 1, p 27 & Ref 5, p 372)

Shōsan. Nitric Acid

Shosoku. Muzzle Velocity

Shotgun. Sandanjū

Shotoyaku (Amatol). A mixture of AN 50 & TNT 50% of brown color, d (cast) 1.59, mp 81°+, Brisance by Plate Dent Test 52% TNT; Expln Temp 265° (dec in 5 secs); Impact Sensitivity BurMinesApp 2-kg Wt 95cm; Power by Ballistic Mortar 124% TNT; Rate of Detonation 6430m/sec (Ref 8, p 16). Was used in same Bombs and in Semisteel (high C cast iron) Shells. Was reported to be found in some Navy Mines (Ref 1, p 27 & Ref 5, p 372)

Shouyaku or Tanayaku (RDX or Cyclonite),

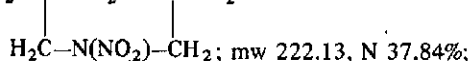
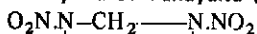

wh crystals, d 1.82, mp 204°; Brisance by Plate Dent Test 135% TNT; Expln Temp 260° (dec in 5 secs); Impact Sensitivity, BurMinesApp, 2-kg Wt 32cm; Power by Ballistic Mortar 150% TNT; Rate of Deton 8180m/sec (Ref 8, p 60). Straight RDX was used as Booster and Sub-Booster in some Army Fuzes, and as Bursting Chge in 20-mm HE Shells. When desensitized with wax, it was used in 37-mm HE Shell (Ref 1, p 26 & Ref 3, pp 282 & 290)

The following expl compns, contg RDX, Angayaku, Chauyaku, Haishokuyaku, Koshitsu, Nigotanoyaku-Mk 2, Tanōyaku, Type 94M Explosive and Unknown Name Explosives were used as Bursting Charges of Bombs and Shells (Ref 5, p 373)

Shrapnel Shell. Ryūsandan

Single-Base Propellants. See under PROPELLANTS

Smoke. Kemurie (en)

Smoke Agent. Hantsuenzai

Smoke Bomb (Hatsuen bakudan). One of such bombs is described here under "Markers and Indicators" and also in Ref 2, p 113-R as Type 2 2-kg Target Indicator. A larger Bomb, weighing 155 lbs, called Type 3, No 6 Target Marker Bomb is also described here and in Ref 2, p 113-L

Smoke Candles (Hatsuentō). See under Smoke Pyrotechnics

Smoke Floats are devices serving as "Sea Markers". Following are examples: 2-kg Smoke Float was a bomb-resembling device, weighing 4.75 lbs, thrown by hand. It contd an igniter and a smoke-producing compn (no data) (Ref 2, p 109, Fig 82)

43-kg Smoke Float consisted of long conical nose and cylindrical tail contg a parachute. Its nose section contd smoke compn and an igniter. It was thrown from a plane (Ref 2, p 110, Fig 83) (See also under Smoke Pyrotechnics)

Smoke Generator (Hatsuenku). See under Smoke Pyrotechnics

Smoke Grenades. See under Grenades

Smokeless Powder (Muenkayaku). See under PROPELLANTS

Smokeless Powder B. See item d under PROPELLANTS

Smoke Powder. Yuenyaku (Nonsmokeless Powder) (Ref 1, p 27)

Smoke-Producing Materials. Following are examples of materials used by the Japanese for producing smokes:

- a) FS Smoke, chlorosulfonic acid 41, sulfur trioxide 54 & sulfuric acid 5%. Used in Type 100 50-kg Smoke Bomb (Ref 2, p 21)
- b) Mixture of titanium & silicon tetrachloride; used in Frangible Smoke Grenade (Ref 2, p 239)
- c) Mixture of hexachloroethane (HC) 56.2, Zn 27.6, Zn chloride 2.9 & Zn oxide 13.3%; used in Smoke Rifle Grenade (Ref 2, p 243)
- d) White phosphorus (WP), used in Type 90 75-mm Smoke (WP) Projectile (Ref 3, p 336)
- e) WP in Type 13-Year 150-mm Smoke (WP) Projectile (Ref 3, p 367)
- f) Berger Mixture, probably similar to the ones described in Vol 2 of Encycl, p 102-L, were used in Smoke Candles listed in Ref 1, p 255 (Compn of Japan mixture not given)
- g) Hexachloroethane (HC) Mixture used in Type 95 50-mm Smoke Mortar (Ref 3, pp 3 & 14)
- h) WP, presumably was used in 140-mm Navy Smoke Projectile (Ref 3, p 494)
- i) FM (Titanium Tetrachloride) used in Navy Type 2 Target Indicator (Ref 1, p 246)
- j) Tannic Acid smoke compn used in Type 94 4-kg Practice Bomb (Ref 2, p 28)

Smoke Projectile or Shell (Hatsuendan). See under AMMUNITION and in Ref 3, pp 336, 367, 374 & 494

Smoke Projector. Emmaku hōshaki

Smoke Pyrotechnics (seizo-jūtsu). The following devices are described in Ref 1, pp 243-46 and 255 *Army Smoke Candles*. Exclusive of self-projecting and floating smoke candles, all smoke candles were of the same basic construction, differing only in size and filling. This type of candle con-

sisted of a cylindrical sheet metal container with a removable metal cover held in place by adhesive tape. The cover protected a match head in the top of the candle and contained a wooden scratch block. To ignite the candle, the scratch block was rubbed against the match head which, after a few seconds delay, ignited the Main Filler. The candle was thrown to, or placed at the spot where smoke was required (Ref 1, p 143). A list of Smoke Candles 1/2-kg, 1-kg and 10-kg is given on p 255. As Main Fillers Berger Mixture, HC (Hexachloro-ethane) and other smoke-producing mixtures were used

Army Self-Projecting Candles usually consisted of an outer tube sealed at one end by a wooden block and provided with protective metal covers held on each end with adhesive tape. The smoke mix was held in a snug-fitting inner container. A match head in the block at the base of the candle was ignited by the scratch block contd in the top metal cover. This ignited a delay fuze which set off the propnt chge and shot the inner tube container outward. A delay element was ignited by the expln and in turn set off the smoke mix. A rod encircled the candle and extended along the length of the candle to form a spike which was inserted into the ground to support the candle at the desired angle for firing (Ref 1, p 243). Same smoke mixes are listed in Ref 1, p 255

Army Type 94 Floating Smoke Candle consisted of a cylindrical metal tube 31¼ inches long and 3¼ inches diam, equipped with a supporting ring to which an automobile rubber tube was attached. It was inflated to support the candle floating in water. The filling was either Berger Mixture (Type 94A) or HC (Type 94B). A metal top covered the fuze pocket which was closed during shipment. Two types of firing mechanisms were used. One type was the ordinary hand grenade igniter without a blasting cap detonator; this gave a delay of 8 secs. The other type was a friction igniter initiated by a small piece of wood painted with abrasive. This produced a delay of up to 30 secs. The candle burned for ca 3.5 mins, producing a dense white smoke which hovered close to the surface of water (Ref 1, p 243, Fig 401)

Navy 40-kg Floating Smoke Generator consisted of a welded steel drum 14 inches high & 12 inches in diam, equipped with carrying handles, a filling hole, a fuze with ignition system, and a spray tube

which extended inside to the bottom of the drum. An inflated rubber tube was attached to the lugs around the drum to float it in water. In operation, the safety pin in the firing assembly was removed and the plunger was struck to fire the detonator and ignite the fuse, a wick, and start the combustion of a slow-burning chge. As pressure from the burning built up in the upper part of the drum the FS smoke mix (See item a under Smoke-Producing Material) in the lower part was forced out thru the emission tube. Upon contact with air, a dense white smoke was formed (Ref 1, pp 244-45). Navy Smoke Float had an aerial bomb body, ca 18 inches long, with three tail fins. It was filled with yellow or black smoke mixtures, an igniter and a small ejection chge. It was dropped from a height less than 700 meters to serve as an aircraft navigation marker (p 245, Fig 403)

Navy Floating Smoke Flare had a long conical nose section and shorter cylindrical tail section with parachute. Overall length 51 inches. The body contd an ejection chge, pull igniter, delay train and a smoke mixture. It was dropped from an aircraft and a parachute slowed the descent of the flare and the delay train permitted the flare to hit the surface of the water before the smoke mix was ignited (pp 245-46, Fig 403)

Navy Type 2 Target Indicator had a bomb-shape thin bakelite body, 17 inches long, 3 inches in diam, filled with FM (Titanium Tetrachloride) smoke mix. The bomb had no fuze because its light body was designed to break (when dropped from a high altitude) on hitting water, thus releasing the smoke mix (Ref 1, p 246 & Fig 404 on p 245)

Smoke Screen. Emmaku

Smoke Signal. Hatsuen shingō

Smooth-Bore. Kakkō nō

Sōkōsha. Armored Vehicle

Spigot Type Mortar. See under MORTARS and in Ref 3, p 389 & Ref 7, p 170

Stabilizing Fin. Dan-yaku

Stick Charges, 50-mm were projectiles fired from Type 98 Discharger. They consisted of

square cast-iron boxes mounted on wooden poles. Each box contd blocks of PA (Picric Acid) with two Pull Igniters. When the projectile is fired these pull igniters are initiated and in turn set off the bursting chge after a short delay. A Blk Pdr proplnt in silk bags, independent of the projectile, is also fired by a pull igniter inserted in the side of the launcher tube. Stick charges may be considered as a special type of army mortar (Ref 3, pp 377-78)

Submarine. Sensuikan

Sucker Traps. See under Sabotage Devices and in Ref 1, pp 231-32

Suicide Boats (Army & Navy). The craft were lightweight plywood, gasolene-driven speedboats 15 to 20 feet long. The Army boat (Ref 1, Fig 39 of p 65) had mounted on its sides two 120-kg depth charges, which released when the boat struck its target. Some boats had a 3rd depth chge mounted over the stern

The Navy boat, shown in Fig 40 had a 640-lb chge of Type 98 Expl chge built into the nose. The boat was exploded electrically upon contact with the target, or by throwing a switch in the cockpit. A stand-by pull igniter firing device was also fitted into the chge

Suirai hashshakan. Torpedo Tube

Suiraitel. Torpedoboat

Sulfuric Acid. Ryūsan

Taihō. A/Tk Gun [Kahō-Gun (general)]

Taijinteki jiral. Antipersonnel Mine

Taikū. Antiaircraft

Tail Fin. Anteiban

Tail Fuze. Dantei shinkan

Taisenshadan. Antitank Bomb

Taisenshafunshindan. Antitank Rocket

Taisensha funshin toshaki. Antitank Rocket Launcher

Taisensha jirai. Antitank Mine

Taka Nos 1, 2 & 3. Gelatin Dynamites

Tama. Bullet

Tanayaku (?). See Shouyaku

Tankei. Ogive

Tanken. Dagger

Tanks (Tanku) and Tankettes are listed here under Combat Vehicles and described, with illustrations, in the book of Tantum & Hoffschmidt, pp 116-29, listed as Ref 7

Tank Gun. Senshaho

Tanōyaku. See under Nigotanoyaku and in Ref 5, p 373, where **No 1** consists of RDX 60, TNT 30 & Tetryl 10%, and **No 2** consists of RDX 55, TNT 38 & Tetryl 7%. They were used as cast-loaded carton charges for various projectiles

Tekidan. Grenade (qv)

Tekidanki. Rifle Grenade Launcher

Tekidantō. Grenade Discharger

Tekishahō. Howitzer. See under ARTILLERY

Tekkodan. Armor-Piercing Projectile

Tenagedan. Hand Grenade. See under GRENADES

Tenka bakkan. Igniting Primer

Tenka shinkan. Igniting Fuze

Tenkayaku. Igniting Charge

Terumitto (Thermite). See Shakunetsuzai

Terumitto shoidan. Thermite Bomb

Teryudan. Tenagedan

Tessen keitei. Trip Wire

Tetryl. See Melayaku

Thermite. Terumitto. See Shakunetsuzai

Thermite Bomb. Termitto shōidan

Thermite Grenade. Termitto tekidan

TNAns (Trinitroanisol). See Type 91 Explosive (Navy)

TNPht (Trinitrophenetol). See Heineiyaku

TNT (Trinitrotoluene); Sanshōki toruōru or **Type 92 Explosive (Navy).** See Chakatsuyaku

Tō. Sword

Tōka hakōdan. Armor-Piercing Bomb

Токеi bakudan. Time Bomb

Токеishiki bakkan. Mechanical Time Fuze

Toku shiraume Nos 1, 2 & 3. Gelatin Dynamites

TORPEDOES (Raigeki suru or Gyorai). Accordg to Ref 1, p 54, the Japanese Torpedoes of WWII were of designs developed during 20 years of research. They were unrivaled in speed and range, yet carrying an extra weight of explosives. They had cigar-shaped bodies and usually were steam-driven. Besides the HE filling and engine, they carried machinery necessary to keep the torpedo on a set course and at a set depth to its target. A typical torpedo is shown in Fig 25 on p 54

A table on p 60 of Ref 1 lists torpedoes used before and during WWII, of which several Types are marked "obsolete" or "obsolescent":

Type 44 Mk 2 Mod contd 400 lbs of Type 97 or 98 Expl (Obsolete)

6th Year Type contd 450 lbs of Shimose (obsolete)

8th Year Type Mk 2 Mod 2 contd 850 lbs of Shimose or Type 98 Expl (Obsolescent)

Type 89 Mod 1 contd 625 to 660 lbs of Type 94, 97 or Shimose (Obsolescent, including its Mod 2)

Type 90 Torpedo contd 880 lbs of Type 94 or Shimose (Obsolete; replaced by Type 93)
Type 93 Model 1 Mod 2 contd 1080 lbs of Type 97 Expl; was 29 ft 6 inches long & 24 inches in diam; used in destroyers and cruisers. It was the standard Navy torpedo and a very superior weapon. There was also a Model 3 carrying 1700 lbs of Type 97 Expl

Type 91 Mods 1, 2, 3, 3 (Special), 4, 6 and 7 were standard aircraft torpedoes of diam 17.7 inches and 17 ft 3 inches to 18 ft 10 inches long which carried 340 to 900 lbs of Shimose, Type 94, 97 or 98 Expl

Type 92 Mod 1, used in submarines, was copied from the Germans and contd 660 lbs of HE (no data). It was electrically driven, while other Japanese torpedoes were steam-driven
Type 94 Mod 1, used in submarines, was 22 ft long & 21 inches in diam. It contd 870 lbs of Type 97 or Shimose

Type 94 Mod 2, used in aircraft, was 17 ft 4 inches long and 17.7 inches in diam. It contd 460 lbs of Shimose

Type 95, apparently the most common submarine weapon, was 23 ft 6 inches long and 21 inches in diam. It contd 880 lbs of Type 98 Expl

Type 97, used in midget subs & PT boats, was 18 ft 5 inches long and 17.7 inches in diam. It contd 790 lbs of Type 97 Expl

Type 2, used in midget subs, was of the same size as Type 97. It contd 774 lbs of Type 97

Type 2 (Special) was an aircraft torpedo, which carried 650 lbs of Type 97

No torpedoes are listed in Refs 2, 3, 5 and 7

Torpedoboat. Suiraitai

Torpedo Tube. Suirai hosshakan

Torpedo Warhead. Suirai-baku hatsusen-tōbu

Tracer (Eikōdan) and Tracer Ammunition (Eikōdan-yaku). Many projectiles contg tracers are listed in Ref 3, but no comps of tracers are given

Trajectory. Dandō

Trinitroanisol (TNAns). See Type 91 Explosive

Trinitrophenetol (TNPhnt). See Heineiyaku

Trinitrotoluene (TNT). See Chakatsuyaku or Type 92 Explosive (Navy)

"TYPE" Explosives. A series of explosives used by the Japanese Navy, which are listed in Refs 1, 5 and below:

Type A (Explosive) or A (ko). See Otsu-B

Type K (Explosive). A series of expls based on mixtures of inorganic salts, developed during WWII. Their compns are not given but they are probably similar to German Ersatzsprengstoffe (Substitute Explosives), listed in Vol 5 of Encycl, pp E121-E122

Type 1 (Explosive). A greenish-ye! expl compn consisting of Ammonium Picrate 81, Al 16, sawdust 2 & heavy oil 1%. Its Brisance by Sand Test was lower than that of TNT; Expln Temp 475°; Impact Sensitivity, comparable to TNT; Power 136% TNT & Rate of Deton 4300m/sec. It was used as press-loaded chges for Depth Bombs or other Underwater Ordnance (Ref 1, p 32 & Ref 5, p 374)

Type 1, Mk 5, P5 (Explosive). A dark-grn expl compn consisting of Amm Picrate 81, ferrosilicon 16, woodpulp 2 & heavy oil 1%. Its apparent density was 1.16; Brisance by Cu Cylinder Crusher Method 99% of PA; Expln Temp 450°; Impact Sensitivity 15cm (maximum for no explns with 5-kg wt); Power by Ballistic Mortar 72% PA & Rate of Deton 4100 m/sec. Used press-loaded in some Depth Charges (Ref 5, p 374)

Type 1 Mk 6, P6. A dark-grn expl compn consisting of Amm Picrate 86, ferrosilicon 11, woodpulp 2 & heavy oil 1%. Its apparent d was 1.13; Brisance 95% PA; Expln Temp 450°; Impact Sensitivity 13cm (max for no explns with 5-kg wt); Rate of Deton 4620m/sec. Used press-loaded in Depth Charges (Ref 5, p 374)

Type 2 (Explosive). See B4 (Incendiary)

Type 4 (Explosive) (Navy). A gray expl compn consisting of Amm Perchlorate 79.2, ferrosilicon 16.4, Al & Fe pdr 1.0, heavy oil 2.5 & unaccounted 0.9%. Its properties are not given, but it was stated in Ref 5 that they were similar to *Type 88 Explosive* (qv), except that it did not burn as easily. Used in Depth Charges (Ref 1, p 32 & Ref 5, p 375)

Type 4 Mk 1, K1. A lt-grayish expl compn con-

sisting of Amm Perchlorate 80, talc 10, ferrosilicon 8 & chloronaphthalene 2%. Its apparent d was 1.24; Brisance 89% PA; Expln Temp 455°; Impact Sensitivity 18cm (max for no explns with 5-kg wt); Power by Ballistic Mortar 84% PA & Rate of Deton 3600m/sec. Used press-loaded in Sea Mines and Depth Charges (Ref 5, p 375)

Type 4 Mk 2, K2. A gray expl compn consisting of Amm Perchlorate 89, woodpulp 5 & coal tar 6%. Its apparent d was 1.0; Brisance 70% PA; Expln Temp 470°; Impact Sensitivity 34cm; Power 82% PA & Rate of Deton 3900m/sec. Used press-loaded in Sea Mines and depth Charges (Ref 5, p 375)

Type 4 Mk 3, K3. A lt gray expl compn consisting of Amm Perchlorate 47, Amm Sulfate 32, ferrosilicon 20 and chloronaphthalene 1%. Its apparent d was 1.20; Brisance 83% PA; Expln Temp 470°; Impact Sensitivity 20cm; Power 81% PA and Rate of Deton 2900m/sec. Used press-loaded in Sea Mines and Depth Charges (Ref 5, p 375)

Type 4 Mk 4, K4. A white expl compn consisting of Na Chlorate with K chlorate 88 & petroleum oil 12%. Its app d was 1.05; Brisance 77% PA; Expln Temp 580°; Impact Sensitivity 14cm; Power 81% PA and Rate of Deton, not given. Used press-loaded in Sea Mines and Depth Charges (Ref 5, p 376)

Type 4 Mk 5, K5. A gray expl compn consisting of Amm Perchlorate 55, Amm Nitrate 29, ferrosilicon 10, woodpulp 5 & heavy oil 1%. Its apparent d was 1.05; Brisance 92% PA; Expln Temp 450°; Impact Sensitivity 28cm; Power 81% PA; and Rate of Deton, not given. Used in Sea Mines & Depth Charges (Ref 5, p 376)

Type 4 Mk 6, K6. A gray expl compn consisting of Na Chlorate 84, woodpulp 6, & petroleum oil 10%. Its appt d was 1.35; Brisance 78% PA; Impact Sensy 17cm; Power 67% PA and Rate of Deton, not given. Used in sea mines & Depth Charges (Ref 5, p 376)

Type 4 Mk 7, K7. A dark-gray expl compn consisting of Na Chlorate 84, woodpulp 5, charcoal 8 & coal tar 3%. Its appt d was 1.2; Brisance 82% PA; Expln Temp 385°; Impact Sensy 25cm; Power 63% PA and Rate of Deton, not given. Used in Sea Mines & Depth Charges (Ref 5, p 376)

Type 88 (Explosive) (Navy) or Karitto (Army).

A gray expl compn consisting of Amm Perchlorate 66, silicon carbide 16, woodpulp 12 & petroleum 6%. Its props are not given, except that it was stated in Ref 1, p 31, that it was dangerous to burn and very sensitive to friction. In Ref 5, p 377 it was stated that it was nonhygroscopic, stable in storage and produced on burning very poisonous fumes.

The Navy used this expl compn loosely packed in Mines and Depth Charges, while the Army used it under the name of *Karitto* in Substitute Demolition Charges. It was proposed to use it also as a Solid Rocket Propellant

This expl compn was used under the name of *Carlit* for industrial purposes and is described in Pamphlet of "The Japan Carlit Co, Ltd" located before WWII in Chiyoda-ku, Tokyo. There are several formulations of *Carlit*, but all of them contain some Amm Perchlorate, but none 66%. (Pamphlet of *Carlit* Co and Ref 5, p 377)

Type 88 (Ko) or Haensosan-bakuyaku, called by "The Japan Carlit Co, Ltd" **Carlit Kuro** (Black), was a gray expl compn consisting of Amm Perchlorate 75, ferrosilicon 16, woodpulp 6 & heavy oil 3%. Its density was 1.05; Brisance lower than that of TNT; Expln Temp 430°; Impact Sensitivity 17cm (max for no explns with 5-kg wt); Power higher than TNT; and Rate of Deton 4400m/sec. Judged by its high Impact Sensitivity and high Friction Sensitivity, 30 to 40 kg (max pressure betw two rubbing surfaces for no explns), instead of usual 60 kg, it was found unsuitable for loading HE Shells, but was suitable for press-loading Navy Mines

Was used as an industrial expl by The Japan Carlit Co, Ltd, Tokyo (Ref 5, p 377 and Pamphlet of *Carlit* Co, Table listing properties)

Type 91 (Explosive) (Navy); **Trinitroanisole** (TNAns); *Methyl Picrate*, or *2,4,6-Trinitrophenylmethyl Ether*, $H_3C.O.C_6H_2(NO_2)_3$; mw 243.13, N 17.28%; yel crystals, d 1.7 & 1.6 for cast; mp 68.4° (pure), 65–67° (coml); Brisance by Cu Cylinder Crusher Test 92% PA or 100% TNT; Expln Temp 279°; Friction Sensitivity 60 kg (max pressure betw two rubbing surfaces for no expln); Impact Sensitivity with 5-kg wt 19cm; Power by Ballistic Mortar 101% PA; Rate of Deton 6660m/sec at d 1.59

It was widely used straight for cast loading

Bombs and Shells as replacement for Shimose (melting at high temp of 122.5°). Was also used for composite expls: *A (ko)* or *Type A (Explosive)*, described here as *Otsu-B*; *Type 2 (Explosive)*, described as *B4 (Incendiary)*; *E (Explosive)*; *Type 98 (Explosive)*, described here as *H2 Kongo*; *Type 94M* (Navy) and some other expl compns (Ref 1, p 32, Ref 5, p 377 and Vol 1 of Encycl, pp A450–451, under Anisole)

Type 92 (Explosive). This term is applied by the Navy to straight TNT which was used in Naval 25-mm & 40-mm Shells. TNT was described here as *Chakatsuyaku*

The term *Type 92* is also applied to a compn consisting of TNT 66 & Al pdr 34% which was cast-loaded in Navy 25-mm Shells. This mixture originated in Germany under the name of *Tritonal*. A similar mixture, but contg TNT 80 & Al 20% was used in the US and described in AMCP 706-177 (1971), p 386 (See Ref 1, p 33 & Ref 5, p 378). Example of use of 66/34 mixture in 25-mm HE Proj is described in Ref 3, p 447

Type 94M (Explosive) (Navy). A cream-yellow expl compn consisting of Trinitroanisole 60 & RDX 40%. Its cast d was 1.64; Brisance by Cu Cylinder Crusher Method 107% PA; Expln Temp 216°; Friction Sensitivity 40–50 kg (max pressure betw two rubbing surfaces for no explns); Impact Sensitivity 13 cm (max for no explns with 5-kg wt); Power by Ballistic Mortar 112% PA; Rate of Deton by Dautriche Method 7700 m/sec. Originated as powerful expl for loading Torpedo Warheads but this use was discontinued due to its sensitivity to Sympathetic Detonation. Later uses included Shaped Charge Grenades and as a Booster Surround (Ref 1, p 32 as *Type 94* & Ref 5, p 379 as *Type 94M*)

Type 97H (Explosive) (Navy) is described here as *Seigata* (Army)

Type 98 (Explosive) (Army & Navy) is described here as *H2 Kongo*

Unknown Name Explosives are listed here under **X-EXPLOSIVES** and also under *Japanese Explosives and Related Items Described in Journals & Patents Listed in Chemical Abstracts After WWII*

Very Pistol. Verii shingō kenjū

Vomit Gas Projectile was 7cm (75-mm) in diam and contd 0.37 lb of crude diphenylcyanoarsine (See **DC** in Vol 2 of Encycl, p C167-R) as a vomit warfare agent and 1.02 lbs of TNT desensitized with 30% naphthalene as burster charge (Ref 3, p 341, Fig 268)

War. Sensō

Warhead. Gyorai jitsuyō tōbu

Weapon. Heiki

White Composition consisting of AN, RDX & GuN (Guanidine Nitrate) was used in conjunction with cast TNT in Type 91 10-cm (105-mm) HE Long Pointed Projectile described in Ref 3, p 352, Fig 278

White Phosphorus (WP) (Hakurin). It was used as an Incendiary and in Incendiary Mixtures in Bombs, Grenades and Projectiles, described here under "Incendiaries" and in Refs 2 & 3. WP was also used in Smoke Compositions as described here under Smoke Producing Materials, items d, e, h and in Refs 2 & 3

X-EXPLOSIVES:

X-1. A light gray to tan mixture of $KClO_3$ & Sb_2S_3 of proportion not given in Ref 1, p 25, but it was the most common mixture for Fuze Primers (See also Ref 5, p 378)

X-2. A chalky-white mixture of PETN 58 & RDX 42% used as filler for Army 7.92-mm and 12.7-mm Ammunition (Ref 1, p 27 & Ref 5, p 379)

X-3. A pressed mixture of RDX 83 & PETN 17% used in 7.7-mm Ammunition (Ref 5, p 379)

X-4. A pressed mixture of RDX 92-95 & wax 8-5% used as a main charge in 20-mm Anti-aircraft Projectiles (Ref 5, p 379) and in Boosters (Ref 3, p 388-R)

X-5. A pressed mixture of RDX 85 & wax 15% used as a Main Charge in 75-mm Armor-Piercing Projectiles (Ref 1, p 27 & Ref 5, p 379)

X-6. A pressed mixture of RDX with Al pdr. Al was evidently added for its incendiary effect (Ref 5, p 379)

X-7. A pressed mixture of PETN & wax. It was used as Main Charge in some Incendiary Shells and as a Booster in 13-mm & 15-mm Shells (Ref 5, p 379)

X-8. A brown expl compn consisting of Amm chlorate 51.5, Ba Nitrate 34.5, Trinitronaphthalene + oil 8.2, woodpulp 5.0 & other ingredients 0.8%. It was used in some Demolition Charges. Dangerous to burn in large quantity (Ref 5, pp 379-80)

X-9. A pressed mixture of RDX & AN (Ammonium Nitrate) used in Type 92 7-cm (70-mm) HE Projectile described in Ref 3, p 304, Fig 236

X-10. A pressed expl compn of RDX 90 & paraffin 10%, coated with graphite and wrapped in Al foil. It was used in Type 1 47-mm and 7-cm (75-mm) Armor-Piercing Projectiles described in Ref 3, pp 299 & 331

Yasenhō (Field Gun); **Yūgekiteki jirai** (Booby Trap). See under MINES

Yuenyaku (Black Powder). See Koko Shokuyaku

Yokosuka Depth Charge. This antisubmarine weapon was not a depth charge in the accepted sense. It was towed under water by escort ships and would explode upon contact with a submerged enemy submarine. The charge was cylindrical in shape, ca 5 ft long & 1 inch in diam, filled with 55 lbs of Type 88 Expl. Vertical and horizontal rudders were fitted on the tail, and an impeller-armed Impact Firing Mechanism was located in the nose (Ref 1, p 65)

References on Japanese Explosives and Related Items Used Before and During WWII

- 1) Anon, "Handbook of Japanese Explosive Ordnance", **OPNAV 30-3M**, USGovtPrintingOff, Washington, DC, Aug 1945
- 2) Anon, "Japanese Explosive Ordnance" (Bombs, Bomb Fuzes, Land Mines, Grenades, Firing Devices and Sabotage Devices); Dept of the Army and the Air Force, **TM 9-1985-4** and **TO 39B-1A-11**, March 1953
- 3) Anon, "Japanese Explosive Ordnance", (Army Ammunition, Navy Ammunition), Dept of the Army and the Air Force, **TM 9-1985-5** and **TO 39B-1A-12**, March 1953
- 4) B.T. Fedoroff et al, "Japanese Ammunition,

Explosives and Weapons", Picatinny Arsenal Manuscript, Unpublished (1955)

5) O.E. Sheffield, "Handbook of Foreign Explosives", **FSTC 381-5042** (1966), pp 360-387, US Foreign Science Technology Center, Munitions Building, Washington, DC 20315

6) Anon, "Military Explosives", Dept of the Army and of the Air Force **TM 9-1300-214** and **TO 11A-1-34**, Nov 1967, Table 8-2 on pp 8-2 & 8-3 for Explosives and Table 11-7 on p 11-4 for Propellants

7) W.H. Tatum IV & E.J. Hoffschmidt, Editors, "Japanese Combat Weapons", Vol 2 of Second World Combat Series, published in 1968 by WE Inc, Old Greenwich, Connecticut 06870

8) W.R. Tomlinson & O.E. Sheffield, "Properties of Explosives of Military Interest", **PATR 1740** (1958), reproduced as Anonymous AMC (Army Materiel Command) Pamphlet **706-177** (1971)

Additional References on Japanese Explosives and Related Items

A) H.T. Creswell et al, "A Dictionary of Military Terms: English-Japanese, Japanese-English", University of Chicago, Chicago, Ill (1942)

B) M. Wiater, "Examination of Japanese 7.7-mm Ball Ammunition (Model 99)", Frankford Arsenal Rept **R395** (1943)

C) A. Suzuki, "Crystalline Structure and Explosibility of Fulminate of Mercury", US Air Technical Branch Rept **0418** (1944)

D) Anon, "Soldier's Guide to the Japanese Army", Military Intelligence Service, War Dept, Washington, DC (1944)

E) Anon, "Data on Foreign Explosives", US Chemical Warfare Service Field Lab Memo **4-6-2** (1944?) (US Office of Technical Services **PB Rept 11544**)

F) J.O. Clements et al, "Japanese Methyl Formate Munition", US Office of Technical Services, **PB Rept 50950** (1944)

G) Anon, "Japanese Military Dictionary", US War Dept Tech Manual **TM 30-541**, US Govt-PtgOff, Washington, DC (1945)

H) Anon, "Explosives and Demolitions", US War Dept Tech Manual **FM 5-25**, US Govt-Ptg-Off, Washington, DC (1945), pp 133-34 (Japanese Explosives)

I) R.L. Cooley et al, "Japanese Explosives", US Naval Technical Mission to Japan Dec 1945,

US Office of Tech Services **PB Rept 53045**

J) Anon, "Allied and Enemy Explosives", Aberdeen Proving Ground, Maryland (1946)

K) G.C. Tibbitts et al, "Japanese Powder and Explosives", US Ordnance Tech Intelligence Rept **6** (1946), US Office of Technical Services **PB Rept 50394**

L) S. Nakahara & T. Hikita, "Studies of Delay Powders", *KôgyôKayakuKyôkaishi* **20**, 275-79 (1958) [US Dept of the Army Translation **I-1955**, ID No 2203235 (October 1962), Report No 1 "Measurement of Combustion Temperature of Delay Powders"; Translation **I-1957**, ID No 2203237 (Oct 1962), Rept No 3 "On Mechanism of Combustion of Delay Powders"; Translation **I-1958**, ID No 2203238 (Oct 1962), Rept No 6, "Theory of Burning Rate of Delay Powders"]

M) Anon, "Manufacturing and Construction (Vehicles, Explosives, Arms and Ammunition)", US OrdnTechIntelligenceRept **OTIA 5801**, Chapter VI, Section 64, pp 64-1 ff (March 1960)

N) R.P. Antonelli, "Encyclopedia of Explosives", US OrdnTechIntelligenceAgency, Ordn Liaison Group, Durham, North Carolina (1960)

O) M.H.B. Smith & J.E. Smith, "Small Arms of the World", Stackpole, Harrisburg, Pennsylvania (1960), pp 498-518

P) Anon, "Tests of M53 Fuze", TechRes & Development Inst, Japan Defense Agency (Sept 1960) [Engl Translation, US Dept of Defense Intelligence Rept **2220044563** (1963)]

Q) Heizo Nambo, "Who Invented Explosives", *KôgyôKayakuKyôkaishi* **28**, 322-29 & 403-23 (1967). Engl translation obtainable for \$15.00, surface mail from Japan Publishers Trading Co, Ltd, PO Box 5030, Tokyo International, Tokyo, Japan

R) K. Sassa & I. Ito, "Studies of Detonation Pressure by Aquarium Technique", *KôgyôKayakuKyôkaishi* (abbrd as **KKK**) **32**, No 6, Nov-Dec 1971. Engl translation by Mrs Geti in 1972 at the Bureau of Mines; available from US Dept of Commerce, NatlTechInfoService, Springfield, Va 22151 (Compositions of Japanese expls *Akatsuki*, *Enoki Dynamite No 2* and *Geogel* are given)

S) Picatinny Arsenal Technical Reports (PATR) and other Reports:

a) A.B. Schilling, "Grenade, Serrated, Cast Iron (With PD Fuze for Japan Type 89 Grenade Discharger)", **PATR 149** (1943)

- b) Ibid, "Grenade, Serrated, Cast Iron (Hand Use or for Japan Type 10 Grenade Discharger)", PATR 150 (1943)
- c) Ibid, "Unfired 20-mm HE Round of Japanese Ammunition", PATR 1236 (1943)
- d) R.M. Dennis, "Drift Signal", PATR 1203 (1943)
- e) W.R. Tomlinson, Jr, "Compilation of Data on the Composition of Foreign Explosives", PATR 1311 (1943)
- f) A.B. Schilling, "Grenade, Hand, Stick Type", PA Fragmentation Rept 193 (1944)
- g) Ibid, "Land Mine and Type 93 Detonator", PATR 1383 (1944)
- h) L.H. Eriksen, "Compilation of Data on the Composition of Foreign Boosters and High Explosives", PATR 1446 (1944)
- i) R.M. Dennis, "Unfired 25-mm HE Shell (Maroon Shell)", PATR 1350 (1944)
- j) Ibid, "Unfired 25-mm HE Shell (Orange Shell, Green Band)", PATR 1351 (1944)
- k) A.B. Schilling, "Unfired AP Rifle Grenade", PATR 1461 (1945)
- l) W.G. Eppler, "Fragmentation of 81-mm HE Mortar Shell, Equipped with PD Fuze", PA Fragmentation Rept 214 (1945)
- m) A.B. Schilling, "Unfired, Serrated Grenade for Hand Use or for Type 10 Grenade Discharger", PATR 1491 (1945)
- n) Ibid, "AP (Shaped Charge) Rifle Grenade with Special Pin Assembly", PATR 1511 (1945)
- o) Ibid, "75-mm Hollow Charge HE Shell Complete Round for Type 41 Mountain Gun", PATR 1521 (1945)
- p) Ibid, "50-mm Non-Serrated Grenade for Type 89 Grenade Discharger", PATR 1544 (1945)
- q) Ibid, "Unfired 88-mm Complete Round HE Shell, Less Fuze", PATR 1557 (1945)
- r) Ibid, "Unfired 70-mm Complete Round HE Shell", PA Memorandum Rept 5 (1952)
- s) Ibid, "Unfired 70-mm HE Complete Round, Model 92 (Japanese Design, Chinese Manufacture)", PATR 1845 (1952)
- t) B.T. Fedoroff & O.E. Sheffield, "Encyclopedia of Explosives and Related Items", PATR 2700: Volume 1 (1960); Volume 2 (1962); Volume 3 (1966); Volume 5 (1972) and Volume 6 (1974), various pages, under Japanese names, which are also listed in this Section of Volume 7

Japanese Explosives and Related Items Described in Journals & Patents Listed in Chemical Abstracts After WWII

Following abbreviations are used for the Japanese Journals and Japanese Patents listed in CA:

JP – Japanese Patent

Japan Kokkai – Japanese National Diet

JapanSciRevEngrgScis – Japanese Science Review Series I. Engineering Sciences – Changed to JapanSciRevMech&ElecEngrg (Printed in Engl)

KKK – KōgyoKayakuKyōkaishi (Journal of the Industrial Explosives Society of Japan)

KKZ – KōgyoKagakuZasshi (Journal of the Chemical Society of Japan. Industrial Chemistry Section)

KKwZ – KōgyoKwagakuZasshi (Journal of the Society of Chemical Industry, Japan, abrd in CA as JourSocChemInd, Japan)

KōjinKwZ – KōjinKwagakuZasshi [Engineers Chemical Journal, Japan, abrd in CA as EngChemJour(Japan)]

TKShH – TokyoKōgyoShikenshoHōkoku (Reports of the Government Chemical Industrial Research Institute, Tokyo)

Following are the titles of Japanese Patents and Papers, arranged in chronological order. A brief description of each subject is given in CA:

1) T. Hikita, "Thermal Decomposition of Some Explosive Compounds", JapanSciRev, Series 1, EngrgScis 1 (2) 23–28 (1950) & CA 45, 2669 (1951)

2) H. Tominaga & T. Kanno, "Combustion of Aluminum Powder", KKZ 53, 106–08 (1950) & CA 46, 8374 (1952)

3) Y. Suzuki, "Explosive Tube from Liquid Carbon Dioxide", JP's 3, 4 & 5 (1950); CA 46, 8376 (1952)

4) Z. Akashi, "Gasless Fuse", JP's 3043 & 3045 (1951); CA 47 (1953)

5) T. Hikita, "Explosion of Perchloric Acid Mixtures", KKZ 54, 253–55 (1951) & CA 47, 2987 (1953)

6) K. Ogawa, "Protecting Cylinder for Mine Explosives", JP 5046 (1951) & CA 47, 2988 (1953)

7) S. Ishiyama, "Ignition Apparatus of Electric Detonator Cap", JP 7242 (1951) & CA 47, 5121 (1953)

- 8) T. Hikita, "Progress in the Theory of Detonation", *KKK* **13**, 3-8 & 77-85 (1952) and *CA* **49**, 2736 (1955)
- 9) T. Kikara & T. Hikita, "Molecular Theory of Detonation", *KKK* **13**, 106-13 (1952) and *CA* **49**, 5841 (1955)
- 10) T. Okawa, "Studies of the Muzzle Flashes of Explosives by Means of High-Speed Cinematographic Camera", *KKK* **13**, 247-54 (1952) & *CA* **49**, 5841 (1955)
- 11) Y. Kato, "Lowering the Viscosity of Nitrocellulose", *JP* **2292** (1952) & *CA* **47**, 6658 (1953)
- 12) T. Hikita & K. Yoneda, "A Method of Measuring Detonation Velocity of Short Charges", *KKK* **14**, 30-33 (1953) & *CA* **49**, 5841 (1955)
- 13) K. Hino, "Gelatinous Dynamite", *JP* **2247** (1953) & *CA* **48**, 4840 (1954)
- 14) S. Kinoshita & T. Sakamaki, "Detonator for Electric Blasting", *JP* **2498** (1953) & *CA* **48**, 6700 (1954)
- 15) R. Kiyama et al, "Explosions under High Pressures", *RevPhysChemJapan* **23**, 43-48 (1953) & *CA* **48**, 8544 (1954)
- 16) K. Hino & J. Sato, "Colloidal Dynamite", *JP* **6196** (1953) & *CA* **48**, 11790 (1954)
- 17) S. Takenaka, "Ignition Composition for Electric Detonators", *JP* **6298** (1953) & *CA* **48**, 12410-11 (1954)
- 18) J. Sato, "Explosive Composition", *JP* **296** (1954) & *CA* **48**, 13222 (1954)
- 19) Y. Tsurusaki, "Explosive", *JP* **148** (1954) & *CA* **48**, 13222 (1954)
- 20) A. Sato, "Explosive Composition", *JP* **988** (1954) & *CA* **48**, 14210 (1954)
- 21) T. Sakurai, "Explosive Composition", *JP* **989** (1954) & *CA* **48**, 14210 (1954)
- 22) N. Sakurai, "Explosive Composition", *JP* **990** (1954) & *CA* **48**, 14210 (1954)
- 23) H. Teranishi, "Explosions under High Pressures", *RevPhysChem, Japan* **25**, 58-63 (1955) & *CA* **50**, 8207 (1956)
- 24) W. Jono et al, "Explosion of Camphor", *KKZ* **58**, 673-75 (1955) & *CA* **50**, 8207 (1956)
- 25) S. Hirose & K. Honma, "Ignition Ball for Electric Detonator Compounded with a Non-combustible Product", *JP* **6748** (1954) & *CA* **50**, 9022 (1956)
- 26) T. Sakurai, "The Brisance of Explosives", *KKK* **16**, 90-94 (1955) & *CA* **50**, 17452 (1956)
- 27) Y. Wakazono, "Delay Composition", *KKK* **16**, 214-18 (1955) & *CA* **50**, 17453-54 (1956)
- 28) N. Tsumagari & F. Takada, "Use of Waste Acid from the Manufacture of High-Brisance Explosives", *JP* **4742** (1955) & *CA* **51**, 18614 (1957)
- 29) Sh. Kikuchi, "Priming Charges for Electric Blasting Caps", *JP* **6297** (1955) & *CA* **51**, 18614 (1957)
- 30) K. Honma & H. Yoshitoni, "A Delay Composition", *JP* **4743** (1955) & *CA* **51**, 17170 (1957)
- 31) T. Toshima & K. Honma, "A Delay Composition for Millisecond Delay Detonator", *JP* **5098** (1955) & *CA* **51**, 17170 (1957)
- 32) Sh. Okubo & S. Ikunuma, "Blasting Caps", *JP* **6898** (1955) & *CA* **51**, 18614 (1957)
- 33) M. Shiunbi, T. Tahara & Sh. Miya, "Colloidal Explosives", *JP* **8096** (1955) & *CA* **51**, 181614 (1957)
- 34) T. Toshima et al, "Ignition Delay Composition", *JP* **8498** (1955) & *CA* **51**, 181614 (1957)
- 35) K. Shiino & S. Oinuma, "Preparation of Tetryl", *TKShH* **51**, 74-76 (1956) & *CA* **50**, 11017 (1956)
- 36) T. Watanabe & O. Murata, "The Double Sympathetic Detonation", *KKK* **17**, 102-11 (1956) & *CA* **50**, 17454 (1956)
- 37) Y. Fukuyama, "Sensitive Ammonium Nitrate", *KKK* **18**, 64-66 (1957) & *CA* **51**, 9159 (1957)
- 38) M. Uretake & M. Hamasaki, "Limits of Explosion of the Systems Alcohol-Air and Ether-Air", *KKK* **18**, 146-53 (1957) & *CA* **51**, 17169 (1957)
- 39) T. Ito, "The Liquid Viscosity of Picric Acid, Trinitroanisole, and Trinitrotoluene", *KKK* **18**, 153-56 (1957) & *CA* **51**, 17169 (1957)
- 40) T. Sakurai, "Brisance of Explosives, Plastic Deformation Flow of Solid Produced by the Detonation of Explosives", *KKK* **18**, 225-36 (1957) & *CA* **51**, 17167 (1957)
- 41) Sh. Okubo, K. Shindo & S. Oinuma, "Copper Azide Detonators. I. Preparation of Copper Azide and Its Impact Sensitivity Test", *TKShH* **52**, 311-14 (1957) & *CA* **52**, 8559 (1958)
- 42) N. Nakashiro & K. Takizawa, "An Industrial Explosive", *JP* **5849** (1958) & *CA* **53**, 16540 (1958)

- 43) K. Konoshita et al, "Waterproof Binder for Explosive Initiators", JP 8797(1958) & CA 53, 4739 (1959)
- 44) I. Ito, Y. Wakazono & Y. Fujinaka, "Delay Composition. The Combustion Mechanism of Minium-Silicon Delay Composition", Suiyokaiishi (Transactions of the Mining and Metallurgical Alumni Assocn) 13, 653-59 (1958) & CA 53, 12680 (1959)
- 45) Sh. Kinoshita & T. Yamazaka, "Delay Composition for Electric Detonators", JP 95 (1959) & CA 53, 20807 (1959)
- 46) T. Soyama, F. Shimogori & N. Otake, "Ammonium Nitrate of Apparent Low Specific Density", JP 2153 (1959) & CA 53, 22956 (1959)
- 47) S. Nakata & M. Yamada, "Apparatus to Manufacture Percussion Caps", JP 2445-9(1959) & CA 53, 16541 (1959)
- 48) K. Hino & S. Hasegawa, "Theory of the Variable Reaction Zones in the Detonation of Industrial Explosives", KKK 20, 2-1 (1959) & CA 54 20205 (1960)
- 49) Y. Wakazono, "Preparation of Delay Composition in Millisecond Detonator", KKK 20, 46-50 (1959) & CA 54, 20206 (1960)
- 50) I. Fakuda, "Explosive Properties of Ammonium Nitrate", KKK 20, 119-35 (1959) & CA 54, 20205 (1960)
- 51) Sh. Nakahara & T. Hikita, "Delay Powders. III. The Mechanism of Combustion of Delay Powders", KKK 21, 2-8 (1960) & CA 55, 11847 (1961)
- 52) K. Okazaki et al, "Properties of Silver Nitrocyamide", KKK 21, 12-15 (1960) & CA 55, 11848 (1961)
- 53) Sh. Nakahara & T. Hikita, "Delay Powders. IV. The Oscillatory Burning of Delay Powders", KKK 21, 86-92 (1960) & CA 55, 11847 (1961)
- 54) K. Hino & M. Yokogawa, "Ammonium Nitrate-Fuel-Surfactant Explosives", KKK 21, 218-26 (1960) & CA 55, 11849 (1961)
- 55) Sh. Nakahara, "Delay Powders. V. Effects of Pressure on the Burning Velocity of Delay Powders", KKK 21, 238-43 & CA 55, 11847 (1961)
- 56) A. Iwama & K. Yamazaki, "Effect of Some Parameters on the Ignition Delay of Hypergolic Bipropellants. I. The Variation With Liquid Temperature, Oxidant Concentration, Subatmospheric Pressure and Fuel Composition", KKZ 63, 1879-83 (1960) & CA 57, 1140 (1962)
- 57) Ibid, "II. The Variation Under Pressure", KKZ 63, 1883-86 (1960) & CA 57, 1140-41 (1962)
- 58) T. Murata & T. Fukuda, "NAP Propellant", KKZ 63, 1900-01 (1960) & CA 57, 1140 (1962) [A new type of solid propellant prepd by treating NH_4ClO_4 + polyester resin composite propellant with NG, MeNO_2 or $\text{O}(\text{CH}_2\text{CH}_2\text{ONO}_2)_2$]
- 59) K. Akimitsu et al, "Experimental Studies of Composite Propellants", KKZ 63, 1902-06 (1960) & CA 57, 1140 (1962) (Composite propellant NH_4ClO_4 + epoxy polysulfide resin was found to be superior to propellant NH_4ClO_4 + polyester resin in both its phys & burning props)
- 60) Sh. Tsuchiya, "Chemical Equilibrium Lag During Rapid Expansion Through Rocket Nozzle", BullChemSocJapan 34, 854-59 (1961) & CA 56, 11871 (1962)
- 61) N. Nakajo et al, "Gelatinization Properties of Nitrocellulose, Nitroglycerol-Nitroglycol Gels", KKK 22, 254-58 (1961) & CA 58, 2318 (1963)
- 62) I. Fukuyama & H. Yoshitomi, "Effects of Sensitive Ammonium Nitrate on Explosibility of Gelatin Dynamite", KKK 23 (1), 23-27 (1962) & CA 59, 8538 (1963)
- 63) S. Tsuchiya, "Flame Temperature of Ammonium Perchlorate Propellants", KKZ 65, 843-47 (1962) & CA 57, 16949 (1962)
- 64) K. Namba, "Calculation of the Heat of Reaction in the Nitration of Glycerol", KKK 23, 76-77 (1962) & CA 63, 9735 (1965)
- 65) Y.N. Tsuchiya, "Crystal Habit Modification of Ammonium Nitrate. III. Application to Ammonium Nitrate-Fuel Oil Explosives", KKK 23, 78-83 (1962) (in Engl) & CA 58, 3262 (1963)
- 66) T. Fakuda & M. Yamada, "Rocket Propellants", JP 395 (1962) & CA 59, 13763 (1963)
- 67) E. Matsumura et al, "Double-Base Rocket Propellants", JP 2797 (1962) & CA 60, 2719 (1964)
- 68) S. Hirose & N. Higashijimima, "Simultaneous Purification and Granulation of Pentrite" (PETN), JP 4443(1962) & CA 62, 5270 (1964)
- 69) M. Aoki & Sh. Motoya, "Free-Flowing Explosive Compositions", JP 4444 (1962) & CA 60, 6695 (1964)
- 70) M. Inagaki, "Rocket Propellants", JP

4445 (1962) & CA 60, 5269 (1964)

71) T. Tosabayashi, "Powdered Explosive for Slow-Burning Fuses", JP 4446 (1962) & CA 60, 5270 (1964)

72) K. Hino & T. Arakawa, "Composite Rocket Propellants Containing Lithium Perchlorate", JP 10747 (1962) & CA 60, 6695 (1964)

73) Y. Matsuda et al, "Solid Rocket Propellants", JP 15796 (1962) & CA 60, 6695 (1964)

74) K. Tsujihashi, "Coal Mine Explosives", JP 15798 (1962) & CA 60, 5270 (1964)

75) K. Nava & H. Honda, "Experimental Studies on Coyote Blasting. III. Time of Scabbing of Free Surface Layer in Coyote Blasting", KKK 23 (5), 226-29 (1962) & CA 60, 2715 (1964)

76) T. Uemura, "Mechanism of Ignition of Methane-Air Mixtures by Electric Detonators", KKK 23 (5), 229-41 (1962) & CA 60, 5269 (1964)

77) T. Suzuki & K. Nakai, "Delay Electric Detonators", JP 942 (1963) & CA 60, 9093 (1964)

78) K. Yamazaki et al, "Polyerethane-Ammonium Perchlorate-Base Propellants Having High Specific Impulse and Slow Burning Rate", TokyoDaigakuKokuKenkyushoShuho (Bulletin of the Aeronautical Research Institute, Univ of Tokyo) 3 (6), 381-89 (1963) & CA 60, 359 (1964)

79) N. Tomoishi & M. Masui, "Commercial Explosives", JP 9590 (1963) & CA 60, 9094 (1964)

80) T. Watanabe & M. Inagaki, "Rocket Propellants", JP 9594 (1963) & CA 60, 7864 (1964)

81) I. Hayashi & T. Sato, "Explosive Compositions", JP 16147 (1963) & CA 60, 9094 (1964)

82) N. Tomoishi & K. Oishi, "Dynamite Explosives", JP 16148 (1963) & CA 60, 7865 (1964)

83) Sh. Nakahara & Y. Honda, "Priming Composition for Electric Detonators", JP 16149 (1963) & CA 60, 15676 (1964)

84) K. Ito & Y. Inumaru, "Waterproof Commercial Explosives", JP 20394 (1963) & CA 60, 10472 (1964)

85) T. Murata & T. Fukuda, "Rocket Propellants", JP 20398 (1963) & CA 60, 10471 (1964)

86) T. Kakutani et al, "Solid Rocket Propellants Containing Binder, Plasticizer, and Surfactant", JP 23798 (1963) & CA 60, 14327 (1964)

87) K. Suzuki, "Properties of Polyether-Epoxy Type Propellants" 5th InternSymp on Space Technology & Science, Tokyo, Japan (2-7 Sept 1963), 61-64. IAA Accession No A65-14296, 3pp (1964) (Engl) & CA 60, 9735 (1965)

87a) M. Uetake & H. Sato, "Ignition of Propellants by Electrostatic Discharge", KKK 24 (2), 67-72 (1963) & CA 60, 11835 (1964)

88) I. Fukuyama & T. Kai, "Salt Pair Explosive for Coal Mining", KKK 24 (3), 140-47 (1963) & CA 63, 6777 (1965) (Two types NG contg expls with salt pairs $\text{NH}_4\text{Cl}/\text{KNO}_3$ and $\text{NH}_4\text{Cl}/\text{NaNO}_3$ were investigated. Both types offered greater safety than the usual mining expls. The salt pair $\text{NH}_4\text{Cl}/\text{NaNO}_3$ made the expl hygroscopic and gave poorer transmission than $\text{NH}_4\text{Cl}/\text{KNO}_3$)

Note: Same paper is listed in CA 60, 11836 (1964) under the title "Ion-Exchange Type Coal Mine Explosives"

89) K. Nawa, "Blasting for Seismic Prospecting", A Review with 58 references, KKK 24 (3), 160-65 (1963) & CA 60, 2715 (1964)

90) K. Yamamoto, "Primary Explosives. II. Thermal Decomposition of Diazodinitrophenol and Other Primary Explosives", KKK 25 (1), 10-19 (1964) & CA 60, 15673 (1964)

91) E. Yoshikawa, "AN-FO Explosives in Europe", KKK 25 (1), 33-38 (1964) & CA 60, 15674 (1964) (A review)

92) Y. Wakazono & Ch. Sato, "Granular Explosives. I. AN-FO Blasting Agents", KKK 25 (2), 63-69 (1964) & CA 61, 9397 (1964)

93) T. Yoshida et al, "AN-FO Explosives. I", KKK 25 (2), 76-84 (1964) & CA 61, 11838 (1964)

94) Sh Okubo & Y. Mizushima, "Tests of AN-FO Blasting Agents", KKK 25 (2), 85-90 (1964) & CA 61, 11838 (1964)

95) K. Yamamoto, "Primary Explosives. III. Thermal Decomposition and Initiation of Primary Explosive-Potassium Chlorate Initiating Compositions", KKK 25 (3), 126-34 (1964) & CA 61, 11839 (1964)

96) Ibid, IV. "Initiation of Lead Thiocyanate-Potassium Chlorate", KKK 25 (3), 134-44 (1964) & CA 61, 11839 (1964)

97) M. Yokogawa, "Combustibility of Ammonium Nitrate Explosives", KKK 25 (3), 156-59 (1964) & CA 62, 8924 (1965)

- 98) H. Fukuda, "Burning of Ammonium Nitrate Explosives", *KKK* **25** (3), 159-60 (1964) & *CA* **62**, 8924 (1965)
- 99) N. Machida et al, "Combustion of Coal Mine Powdered Explosives", *KKK* **25** (3), 164-68 (1964) & *CA* **61**, 11837 (1964)
- 100) K. Namba, "Developments in the Synthesis of Explosive Substances", *KKK* **25** (4), 206-15 (1964) & *CA* **62**, 8924 (1965) (A review with 26 references)
- 101) K. Otsubo, "Chemical Engineering in the Explosive Industry", *KKK* **25** (4), 216-24 (1964) & *CA* **62**, 8924 (1965)
- 102) K. Yamamoto, "Primary Explosives. V. Ignition of Primary Explosives When Heated in an Electric Furnace", *KKK* **25** (5), 258-70 (1964) & *CA* **62**, 8923 (1965)
- 103) K. Shiino & S. Oinuma, "Nitration Product of Monomethylurea Nitrate", *KKK* **25** (5), 283-90 (1964) & *CA* **62**, 8923 (1965)
- 104) K. Kimura, "Slurry Explosives", *KKK* **25** (5), 293-97 (1964) & *CA* **62**, 8924 (1965) (A review with 10 refs)
- 105) K. Yamamoto, "Primary Explosives. VII. Sensitivity of Primary Explosives to Mechanical Action", *KKK* **25** (6), 330-42 (1964) & *CA* **64**, 3273 (1966)
- 106) K. Yamazaki & H. Tokui, "The Cross-Linking Reaction of Polybutadiene Binder for Composite Propellants", *BullChemSocJapan* **38** (12), 2774-78 (1965) (English) & *CA* **64**, 6391 (1966)
- 107) K. Kiyota, "How We Use Explosive Forming Technology", *KKK* **26** (1), 3539 (1965) & *CA* **64**, 3274 (1966) (A Review)
- 108) K. Yamamoto, "Primary Explosives. X. Hazardous Properties of $\text{Pb}(\text{CNS})_2$ - KClO_3 Mixtures", *KKK* **26** (2) 66-73 (1965) & *CA* **64**, 6394 (1966)
- 109) K. Yamamoto, "Primary Explosives. XI. Sensitivity of DDNP (Diazodinitrophenol)- KClO_3 Mixtures and Effects of S in DDNP", *KKK* **26** (2), 74-82 (1965) & *CA* **64**, 6394 (1966)
- 110) Y. Mizushima, "Gap Test in Hard Polyvinyl Chloride Tubes", *KKK* **26** (2), 96-97 (1965) & *CA* **64**, 6393 (1966)
- 111) Y. Mizushima, "Measurement of Blast Wave Pressure", *KKK* **26** (3), 142-55 (1965) & *CA* **64**, 3274 (1966) (A review with 42 refs)
- 112) T. Mataka, "Rocket Propellants", *KKK* **26** (4), 190-92 (1965) & *CA* **64**, 3273 (1966)
- 113) H. Osada & N. Kakinouchi, "Initiation of Ignition of Solid Rocket Propellants", *KKK* **26** (4), 200-11 (1965) & *CA* **64**, 3273 (1966)
- 114) M. Mochizuki, "High-Altitude Combustion of Solid Propellant Rockets", *KKK* **26** (4), 211-15 (1965) & *CA* **64**, 6392 (1966)
- 115) H. Sakai, "Inflammable Resins", *JP* **16154** (1965) & *CA* **64**, 521 (1966)
- 116) Asahi Chemical Industry Co, Ltd, "Automatic Manufacture of Dynamite", *BelgP* 669299 (1965) & *CA* **65**, 10420 (1966)
- 117) M. Nimi, "The Sensitivity of Explosives", *KKK* **27** (2), 71-72 (1966) & *CA* **65**, 6987 (1966) (A review with 6 refs)
- 118) K. Yamazaki & H. Tokui, "Composite Propellants Containing Epoxidized Polybutadiene as Fuel Binder", *KKZ* **69** (3), 575-78 (1966) & *CA* **65**, 10415 (1966)
- 119) K. Sassa & G. Larocque, "Measurement of Detonation Velocity in Bore Holes by Resistance Probe", *KKK* **27** (4), 223-28 (1966) & *CA* **66**, 6374 (1967)
- 120) K. Sasa & I. Ito, "Measurement of Detonation Pressure of Explosives by Modified Aquarium Technique", *KKK* **27** (4), 228-33 (1966) & *CA* **66**, 6374 (1967)
- 121) M. Shinohara & M. Sakaguchi, "Some Experiments on Sensitivity of Nitroglycerol", *KKK* **27** (5), 303-05 (1966) & *CA* **66**, 6373 (1967)
- 122) J. Sato, "Mechanical Properties of PETN-Epikote 871 Composite Explosives", *KKK* **27** (5), 306-08 (1966) & *CA* **66**, 6373 (1967)
- 123) K. Yamazaki & H. Tokui, "On the Composite Solid Propellant Impregnated with Metallic Foil", *BullChemSocietyJapan* **40** (5), 1249-53 (1967) & *CA* **67**, 5261 (1967)
- 124) K. Yamazaki, "Solid Rocket Propellants Burning Characteristics", *KKK* **28** (5), 356-63 (1967) & *CA* **68**, 9401 (1968) (A review)
- 125) H. Shimizu et al, "Acetylenic Propellants. I. Synthesis of Acetylenic Propellants", *KKK* **28** (5), 386-90 (1967) & *CA* **68**, 9401 (1968)
- 126) H. Yoshitomi, "Nitric Oxide and Nitrogen Dioxide in Blasting Gas", *KKK* **28** (6), 447-51 (1967) & *CA* **68**, 9402 (1968)
- 127) T. Wakabaishi, "Liquid Oxygen Explosives", *Koalsu Gasu* **1967**, **4** (2), 87-89 (Japan) & *CA* **69**, 68687 (1968)
- 128) H. Kimura & H. Tamada, "Slurry Explo-

- sives", JP 19239 (1968) & CA 70, 105 (1970)
- 129) K. Suzuki et al, "Combustion Stabilization of Composite Propellants", JP 19240 (1968) & CA 70, 105 (1970)
- 130) Y. Namura & J. Sato, "TNT (Trinitrotoluene)-Based Explosive Compositions Containing Acrylamide Polymer Gel as Gelatinizer. I. Preliminary Experiments, KKK 29 (5), 300-07 (1968) & CA 71, 141 (1969)
- 131) Y. Nomura & J. Sato, "TNT-Based Explosive Compositions Containing Acrylamide Polymer Gel as Plasticizer. II. Detonation Velocity in the Closed State", KKK 29 (6), 427-31 (1968) & CA 71, 141 (1969)
- 132) T. Suzuki et al, "Small-Arms Single-Base Propellant Charge", USP 3442213 (1969) & CA 71, 118 (1969)
- 133) S. Minekawa et al, "Flexible Explosive Compositions Containing Block Copolymers", USP 3449179 (1969) & CA 71, 92 (1969)
- 134) I. Hayakawa & T. Harada, "Oxidants for Composite Rocket Propellants", JP 05717 (1969) & CA 72, 125 (1970)
- 135) H. Nagato et al, "Solid Rocket Propellants", JP 05718 (1969) & CA 71, 172 (1969)
- 136) T. Yokoyama et al, "Solid Rocket Propellants", JP 05719 (1969) & CA 71, 172 (1969)
- 137) K. Takata et al, "Preventing the Caking of Ammonium Nitrate for Use in Explosives", GerOffen 1906776 (1969) & CA 71, 172 (1969)
- 138) K. Tsujihashi et al, "Continuous Mixing of Nitroglycerol with Guncotton", JP 10109 (1969) & CA 71, 173 (1969)
- 139) K. Tsujihashi et al, "Continuous Gelation of a Mixture of Nitroglycerol and Guncotton", JP 10111 (1969) & CA 71, 173 (1969)
- 140) T. Kashimura et al, "Fuel and Binder for Rocket Propellants", JP 10114 (1969) & CA 71, 172 (1969)
- 141) Y. Ishitani & S. Akimaru, "Explosive Compositions Useful for Metal Processing", JP 10115 (1969) & CA 71, 143 (1969)
- 142) M. Shimohara et al, "Waste Molasses for Stabilizing Industrial Liquid Explosives", JP 10116 (1969) & CA 71, 173 (1969)
- 143) N. Nakashima, "Igniter Composition for Solid Rocket Propellants", JP 10117 (1969) & CA 71, 172 (1969)
- 144) A. Tanaka et al, "Polybutadiene Mixed Solid Propellants", JP 10118 (1969) & CA 71, 142 (1969)
- 145) H. Wakamiya et al, "Electric Detonators or Delayed Explosives", JP 10118 (1969) & CA 71, 143 (1969)
- 146) K. Yamazaki & K. Kishi, "Composite Solid Propellant Containing Preshaped Oxidizer Salt-Metallic Fuel-Burning Rate Controller Particles", USP 3454437 (1969) & CA 71, 161 (1969)
- 147) K. Ito et al, "Ammonium Nitrate Explosives for Coal Mines", JP 17518 (1969) & CA 72, 110 (1970)
- 148) Y. Nomura, "Explosive Compositions Containing Acrylamide Gels as Plasticizers", JP 17519 (1969) & CA 72, 125 (1970)
- 149) T. Yamagi et al, "Porous Granular Ammonium Nitrate Production", JP 18573 (1969) & CA 71, 142 (1969)
- 150) I. Hayakawa, "Composite Rocket Propellants", JP 27318 (1969) & CA 72, 96 (1970)
- 151) T. Kakuda et al, "Propellants", JP 28396 (1969) & CA 72, 133 (1970)
- 152) A. Iwama, "Solid Propellants Containing Titanium Dihydride", JP 28397 (1969) & CA 72, 158 (1970)
- 153) T. Harada & I. Omura, "Composite Rocket Propellants with Carboxy-Terminated Binders", USP 2476622 (1969) & CA 72, 158 (1970)
- 154) T. Yamashita et al, "Fluorine Containing Polymers as Propellant Binders", KKK 30 (3), 157-61 (1969) & CA 72, 153 (1970)
- 155) J. Okabe et al, "Slurry Explosives Containing Lignin-Chromium Complexes Having Plastic Characteristics and High Density", GerOffen 1915456 (1969) & CA 72, 110 (1970)
- 156) K. Tanaka et al, "Underwater Explosion in a Closed Vessel", KKK 30 (4), 333-40 (1969) & CA 78, 109 (1973)
- 157) Y. Wakazono & Y. Otsuka, "Slurry Explosives Containing an Improved Thickening Agent", USP 3524777 (1970) & CA 73, 112 (1970)
- 158) T. Takei & S. Fujihira, "Explosive Compositions", JP 08676 & 08677 (1970) & CA 73, 95 (1970)
- 159) T. Fukuda et al, "Cellulose Acetate Coated Propellants", JP 09279 (1970) & CA 73, 111 (1970)
- 160) N. Tomoishi, "Low Density Colloidal Dynamite", JP 09280 (1970) & CA 73, 111 (1970)
- 161) K. Kishi & T. Yamazaki, "Mixed Solid

- Propellants", JP 20198 (1970) & CA 74, 138 (1971)
- 162) H. Sato & F. Yoshida, "Propellant Blocks", JP 20199 (1970) & CA 74, 98 (1971)
- 163) H. Sato & F. Yoshida, "Propellant Blocks", JP 20200 (1970) & CA 74, 98 (1971)
- 164) M. Hamasaki & N. Nakashima, "Method of Cracking Concrete for Demolition Purposes", BritP 1205378 (1970) & CA 74, 98 (1971)
- 165) K. Kishi & T. Yamazaki, "Solid Propellant Mixtures", JP 28318 (1970) & CA 74, 179 (1970)
- 166) T. Maeda, "Composite Propellants Containing Resin Binder", JP 34959 (1970) & CA 75, 146 (1971)
- 167) K. Kishi & Sh. Yamazaki, "Priming Compositions for Solid Rocket Propellants", JP 34960 (1970) & CA 75, 130 (1971)
- 168) K. Tanaka, "Electric Signals Accompanied with Detonation of Explosives. II. Signals Originated from the Product Gas", KKK 31 (1), 28-31 (1970) & CA 78, 109 (1973)
- 169) O. Katsuki et al, "Combustion Preventive Chemicals for Coalmine Explosives. I. Organic Compounds", KKK 31 (3), 131-37 (1970) & CA 78, 108 (1973)
- 170) Y. Hara & H. Osada, "Thermal Decomposition of Ammonium Nitrate and a Mixture of Ammonium Chloride and Sodium Nitrate", KKK 31 (4), 236-43 (1970) & CA 78, 109 (1973)
- 171) H. Sakai & K. Tsutsui, "Industrial Explosives Containing Polyethyleneglycol Esters", JP 01600 (1971) & CA 76, 101 (1972)
- 172) Z. Meisek, "Sensitive Ammonium Nitrate Explosives", JP 15798 (1971) & CA 76, 133 (1972)
- 173) M. Hamasaki et al, "Gas Producing Compositions", GerOffen 2063580 (1971) & CA 75, 80 (1971)
- 174) Y. Nomura, "Plastic Explosives" JP 22760 (1971) & CA 77, 196 (1972)
- 175) Y. Wakazono et al, "Slurry Explosives Containing Aluminum Powder", S. AfricanP 69 07340 (1971) & CA 75, 104 (1971)
- 176) T. Harata & T. Maeta, "Solid Propellants", JP 26119 (1971) & CA 79, 147 (1973)
- 177) T. Maeta, "Composite Propellants Containing Adhesive and Combustion Retardants, JP26120 (1971) & CA 79, 147 (1973)
- 178) M. Hamazaki & N. Nakajima, "Explosive Compositions for Blasting Concrete", JP 27397 (1971) & CA 78, 129 (1973)
- 179) I. Araki & T. Nakayama, "Application of Liners for Solid Propellants", JP 06236 (1972) & CA 79, 147 (1973)
- 180) T. Ishimoto et al, "Aluminum-Magnesium Alloys as Priming Compositions", JP 14359 (1972) & CA 79, 148 (1973)
- 181) J. Kaneko & J. Nomura, "Propellant Compositions", JP 14360 (1972) & CA 79, 147 (1973)
- 182) Y. Matsuguma et al, "Combustion Preventive Chemicals for Coalmine Explosives. II. Inorganic Compounds", KKK 33 (4), 214-22 (1972) & CA 78, 108 (1973)
- 183) S. Minekawa et al, "Self-Supporting Explosives", GerP 1646268 (1972) & CA 78, 129 (1973)
- 184) T. Ohmori & E. Tane, "Ignition Agent for Solid Fuel, JP 51202 (1972) & CA 80, 147 (1974)
- 185) Sh. Azaka et al, "Glue-Like Dynamite", JP 15480 (1972) & CA 79, 66 (1973) and CA 81, 141 (1974)
- 186) M. Takeda, "Moisture-Resistant Match Tips Containing Glyoxal", JapanKokai 23909 (1973) & CA 79, 89 (1973)
- 187) H. Hijikata, "Sulfur-Free Match Tip Composition with High Porosity", JapanKokai 23910 (1973) & CA 79, 89 (1973)
- 188) M. Takeda, "Match Striker Composition Containing Urea Resin as Adhesive", JapanKokai 23911 (1973) & CA 79, 89 (1973)
- 189) D. Fakuma et al, "Stretchable Composite Propellants", JapanKokai 23912 (1973) & CA 79, 115 (1973)
- 190) D. Fakuma et al, "Powder Propellants with Good Uniformity", JapanKokai 23913 (1973) & CA 79, 89 (1973)
- 191) A. Iwama, "Annual Review of Fuels for 1973. Rocket Fuels", Nenryo Kyokai Shi 52 (6), 390-94 (1973) & CA 79, 65 (1973)
- 192) M. Shinohara & K. Ohishi, "Industrial Explosives", Japan 05838 (1973) & CA 79, 76 (1973)
- 193) K. Inoue et al, "Isocyanate Additive for Propellant", JapanKokai 67415 (1973) & CA 80, 123 (1974)
- 194) K. Inoue et al, "Diketone Stabilizers for Propellants", GerOffen 2263037 (1973) & CA 79, 147 (1973)
- 195) A. Asano, "Smoke-Controlling Oily Agent

for Ammonium Nitrate-Fuel Oil Explosives", JapanKokai 85712 (1973) & CA 80, 112 (1974)
 196) U. Krone, "Pyrotechnic Compositions", JapanKokai 2164437 (1973) & CA 80, 121 (1974)
 197) A. Yokoyama, "Solid Propellants with Improved Combustibility", JapanKokai 98007 (1973) & CA 80, 34 (1974)
 198) Sh. Yamaguchi et al, "Solid Rocket Fuel", JapanKokai 99311 (1973) & CA 80, 71 (1973)
 199) T. Yamazaki et al, "Electric Igniter Charges", Japan 08848 (1974) & CA 81, 144 (1974)
 200) H. Misashi & Y. Hori, "Waterproof Binders for Explosives", Japan 09733 (1974) & CA 81, 145 (1974)

Jarrett, G. Burling, Col, US Army (1902--1974). Founder and curator emeritus of the world-famous US Army Ordnance Museum at Aberdeen Proving Ground, Maryland. His knowledge of armaments not only of the USA but also of foreign countries helped US Government in selecting new weapons, thus saving many dollars. He retired from the Army in 1966, but stayed on as a voluntary researcher with the APG Museum, with the title of Curator Emeritus
Ref: Anon, "In Memoriam. G. Burling Jarrett", National Defense, Sept-Oct, 1974, p 135

JATO. Abbreviation for Jet Assisted Take Off which refers to the use of an auxilliary rocket motor for added thrust in the take-off of an aircraft. The usual JATO units are solid propellants (Ref 2):

Rocket description	12 AS-1000 D-1
Charge type	End-burning
Purpose	Assisted take-off of aircraft
Thrust, lb	1000 (rated)
Burning time, sec	12 (rated)
Impulse, lb-sec	16,000 (actual)
Propellant	Asphaltic composite
Outside tube diam, in	9.6
Length, in	36
Gross weight, lb	205
Propellant weight, lb	90

However JATO units based on liq propellants have also been used for example the "Tonka" fuels used with white fuming nitric acid (Ref 1). Tonka fuels are mixtures of aniline, monomethylaniline, dimethylaniline,

naphtha, triethylamine & iso-hexylamine
Refs: 1) H. Gartmann, Weltraumfahrt No 6, 134 (1951) & CA 46, 4233 (1952) 2) O.E. Lancaster, Edit, "Jet Propulsion Engines", Princeton Univ Press, Princeton, NJ (1959), p 528 3) J.W. Herrick & E. Burgess, "Rocket Encyclopedia Illustrated", Aero Publ, Los Angeles, Calif (1959), pp 240-42

JB-2 Bomb. The American copy of the Ger "buzz bomb". The chge consisted of a perforated cylinder, 8.5 inches OD, 2.5 inches ID, 36.5 inches long, and weighed 120 lbs. It developed at 70°F a thrust of 11000 lbs for a period of 1.85 secs. Four of these chges, each encased in a suitable motor, were attached to a launching sled, which ran on a heavy non-portable rail system. By an ingenious development of the US Air Forces, the bomb, sled & rocket motors were converted to what amounted to a free flight rocket. This light, highly portable launching system had a great advantage over the heavy & rigid German launchers

The JB-2 Bomb did not come into combat use, although a requirement for 500 launching units a month existed at the end of WWII. The construction of a production plant with a capacity of 600000 lbs of proplnt a month (sufficient for 1200 launchings) was nearing completion. Interest in the JB-2 Bomb remained sufficiently high so that the pilot plant was converted to a small production plant for peacetime operation

Ref: Summary Technical Rept of Div 8, NDRC, "The Preparation and Testing of Explosives", Vol 1 (1946), pp 98-99

JB Powders. Smokeless proplnts, patented originally in 1888 by Johnson & Borland, and manuf for many years by the EC Powder Co Ltd, Greenhite, England (See EC Powders in Vol 5 of Encycl, p E6-R). The *military proplnt* contd NC 50, KNO₃ 40 & roasted starch (partly burned) or lampblack 10%. A *sporting proplnt* contd NC 50, KNO₃ 22, Ba(NO₃)₂ 25 & roasted starch or lampblack 3%. These powders are no longer manufactured
Ref: Daniel (1902), pp 386-87

JCP Powder. One of the varieties of plasto-minerites. It is a sporting smokeless proplnt contg NC, DNT & Ba nitrate
Ref: Daniel (1902), pp 387 & 634

Jelly Bag Method of Mixing. See under Drums, Rotary (Rotating) for Blending (Mixing) of Explosives and Their Components in Vol 5 of Encycl, p D1556-R

Jelly, Mineral. Same as vaseline

Jensen's Test (For Stability of Explosives). Test tubes, each contg 0.1g of a NC expl, are suspended in a bath of mineral jelly preheated to 100°. A strip of KI-starch paper is suspended above the sample. Heating of the bath is continued, by raising the temp 5° per min, until the point is reached at which the test paper begins to color. This point is taken as an indication of the stability of the NC proplnt. Jensen's Test is a combination of the deflagration test of Sy and the Abel Heat Test
Ref: Reilly (1938), pp 80 & 83

Jetcord. An Explosives Technology (Fairfield, Calif) development which is special expl chge similar to the military shaped, or "hollow chge". It consists of a metal-sheathed, expl-filled, linear-shaped chge, having an approx chevron-shaped cross section. Jetcord is available in a size range (1000, 2000 & 4000 grains/ft expl chge) that permits the cutting of a few mills of Al up to 3 inches of steel. Initiating the expl device raised a problem. The use of conventional, highly sensitive electric blasting caps would not be feasible in the vicinity of high-powered elec machinery. An alternative was to use a very insensitive device known as Exploding Bridgewire (EBW) detonators developed during WWII (See in Vol 4 of Encycl, p D807-L and in Vol 6, p E353-R). EBW detonators differ from conventional types in that they require currents of thousands of amps delivered in a few microseconds before they will detonate. Under such elec impulses, the detonator bridgewire literally explodes, and the resulting high temp shock adequately initiates Jetcord

Typical Jetcord comes in a variety of sizes for special applications. The powerful linear-shaped chge permits demolition contractors to cut supporting steel structures with a few ounces of expl rather than depend on the blast effect of large quantities of expls. Jetcord has been used successfully to demolish buildings & bridges
Ref: Industrial Research Magazine (April 1974), pp 67-70

Jet Formation in Shaped Charges. See Detonation; BMT (Birkhoff-MacDougall-Pugh-Taylor) Theory of Jet Formation in Shaped Charges in Vol 4 of Encycl, p D226-R; and Detonation, Munroe-Neumann Effect (or Shaped Charge Effect) and Lined-Cavity Effect in on pp D442-Rff

JET FUELS. *Introduction.* These are fuels for air-flow jet propulsion systems (See Jet Propulsion in this Vol). Fuels for rockets are described, in part, under Hypergolic Propellants in this Vol, pp H254ff. Air-flow jet propulsion systems are divided generally into two categories: those needing an external source of ignition and those that are self-igniting or hypergolic

Recent literature on jet fuels is very extensive, eg between 1957 & 1971 there are some seven pages of Refs to jet fuels in CA indexes and these probably do not include all contract research reports and certainly not classified literature. What follows is a summary of the props & requirements of the most common jet-aircraft fuels (JP series) and a list of recent review articles on these and other jet fuels of special interest

Jet Fuels (Grades JP-3, JP-4, JP-5 & JP-6). Specifications for early aircraft jet fuels were based primarily on manufg considerations, since it was believed that aircraft could burn almost anything of the nature of kerosene fuels (Ref 1). Later improvements in aircraft, particularly in high-speed jets, made it necessary to pay more attention to fuel characteristics and less attn to ease of manuf. The most important of these fuel characteristics is fuel stability at high temps. Other problems associated with jet aviation fuels, both for military & civilian use, are minor compared to stability at high temps. Such problems include availability, handling & physical property specifications

The need for thermal stability of jet fuels is based on the following facts. In supersonic flight, the aircraft is subjected to high temperatures. This heat must be removed. Most convenient solution, in many types of jet aircraft, would be to use the fuel as a heat sink for cooling vital aircraft components, such as engine oil.

Theoretically, use of fuel as a coolant is convenient. But, it is well known that heating oils for even short periods of time accelerates gum and sediment formation. (In fact, this is the basis for many stability prediction tests in the petroleum industry.) It was not unexpected then, that when fuels are heated in aircraft fuel systems, temperatures would be high enough to cause some fuel degradation.

Mechanism studies of this disintegration have been resolved into three thoughts:

- a) fuel is cracked
- b) fuel is oxidized
- c) fuel is polymerized

Most workers in this field believe polymerization to be the cause of sediment which plugs filters and deposits lacquers on such vital parts as heat exchanger surfaces.

Although petroleum refiners are not unfamiliar with questions of thermal stability of petroleum products, jet fuel stability requirements (stable in the range 400–500°F) presented a new set of problems. One of the first things to be done was to define limits of acceptable stability. Such limits naturally would depend upon individual engine design and the environment to which the fuel is exposed. Fuels meeting one set of conditions could conceivably fail to meet another set. The solution: devise some sort of laboratory test that would correlate with actual engine performance.

Pioneering efforts in this were carried out by Pratt & Whitney and Du Pont. Working with a scaled down fuel system, they were able to obtain some degree of correlation with engine performance. But, around the same time, others interested in this problem – refiners, engine manufacturers, and air frame designers – began to build test rigs. Soon there were as many devices as there were groups involved in the thermal stability problem. Consequently, a meeting was arranged to suggest a suitable piece of equipment and set up a program for evaluation

of jet fuels under defined conditions. The apparatus selected was called the Erdco Jet Fuel Coker. Data correlation was undertaken by the Coordinating Research Council, an organization sustained jointly by the Society of Automotive Engineers, and the American Petroleum Institute.

With this Erdco coking unit, the test fuel under consideration is pumped thru an annular heat exchanger. Hot fuel then passes thru a heated sintered steel filter. Fuel, flow rate, fuel temperature, and filter temperature can be varied over a wide range to control test severity. Insoluble sediment which is formed during the heating operation deposits on the filter. The time required to achieve a given pressure drop across the filter is a measure of fuel stability. Visual observations of the heated tubes are made to estimate heat exchanger fouling tendencies.

More specifically, typical operating conditions are: a flow rate of 4 pounds per hour, a fuel temperature from the heat exchanger of 400°F, a filter temperature of 500°F, and a fuel pressure of 150 pounds per square inch gage. Fuel stability is then determined by operating until a pressure drop of 25 inches of mercury is obtained across the filter or until 300 minutes have elapsed. No heater tube appearance requirements have been designated.

Some characteristics and requirements of the JP Series of fuels is given below (Ref 1) (more detailed characteristics are presented later):

JP-3 (Used by Military). A mixture of about 70% gasoline and 30% light distillate. Specifications limiting boiling range are a 5 to 7 pound Reid vapor pressure and a maximum 90% evaporated point of 470°F.

JP-4 (Used by Military and Commercial). A mixture of about 65% gasoline and 35% light distillate. Reid vapor pressure specification is 2 to 3 pounds. Product was developed as a replacement for JP-3 because of excessive fuel losses encountered at high altitudes with JP-3.

JP-4 referee (Used by Military). A special grade of JP-4 having rigidly specified characteristics. Fuel is designed to be typical of lower quality JP-4 fuel which would be available in wartime. Used in developing and testing of military jet engines.

JP-5 (Military). Essentially a specially fraction-

ated kerosine. Flash point is higher (140°F) and freezing point (-40°F) lower than most kerosines

Kerosine (Used by Commercial) has essentially the same requirements as burning kerosine with the exception of freezing point. Commercial airlines usually require freezing point of -40°F maximum because of the low temperatures encountered at altitude. Many, but not all, burning kerosines will meet this requirement

Attempts have been made to increase the stability of the above fuels by:

- a) use of processing or treating techniques
- b) incorporation of additives
- c) segregation of stable stocks

Use of conventional treating processes was the logical starting point for improving thermal stability since refiners already have these facilities. One of the first treating processes considered was sulfur dioxide treatment, although current capacity would possibly be insufficient in an all-out war. In tests carried out at one petroleum laboratory, a JP-5 fuel stability was increased twofold. Untreated fuel had a stability rating of 57 minutes. After sulfur dioxide extraction, the time was increased to 119 minutes. However, for all intent and purpose, this is not considered to offer any benefits since the test defines acceptable stability as 300 minutes

Another refinery treating procedure is acid treatment. This method is somewhat successful. In further test on a JP-5 fuel at the above mentioned laboratory, the improvement factor was 2.5 or 157 minutes. Actually, effectiveness of treating depends upon the crude oil supply and its appearance after original refining, that is, first separation from the crude. What would be described as mild treatment is good for one refiner, but another, because of crude supply, would need much higher treats, say to the order of 25 to 50 pounds per 42-gallon barrel, before a stable product is obtained. Acid treating is not favorable from the processing side, but it is possible to produce high quality fuels with the process

A better approach to achieving thermal stability is thru hydrogenation. Hydrogen is now readily available in most refineries because of catalytic reforming developments. Hydrogenation produces fuels of excellent thermal stability.

Again citing the laboratory example above, the same JP-5 fuel hydrotreated shows improved stability to 300 plus minutes

Use of hydrogen is effective in removing trace constituents, often times the bad actors, such as nitrogen and sulfur. Also, hydrogen saturates previously unsaturated olefins or aromatics which may be present. The amount of hydrogenation depends again, upon the source of crude oil. Good crudes may only need mild hydrogenation, other cases, heavy

Another possible solution to the problem of high temperature stability is the use of additives. Not exactly a stranger to petroleum people (as evidenced by use in gasoline and lubricants) they generally fall into two classes: metallic and non-metallic. The former, for the most part are metal salts of sulfonates or naphthenates, whereas the latter are either amines or amine derivatives (later other organics may prove more effective)

Use of additives in jet fuels, however, must of necessity be approached with caution. As surface active materials, many have a variety of uses and properties. Hence, they must not introduce new problems such as foaming at high altitudes, emulsification, or interference with low temperature flow. These could easily be severe limitations, but additives are under serious consideration thruout the industry

Additives can be most effective when contaminants causing instability have been minimized by refinery processes such as hydrogenation. In general, however, the prime purpose of an additive is either to dissolve or prevent formation of sludge or else to disperse sediment in fine particles which enables passing thru filters and other vital engine parts. The problem is of prime concern in the case of metallic type additives which can build up ash deposits, which can seriously affect jet engine operation. An appreciable slug of ash can do extensive damage if suddenly tossed thru a jet engine

Studies have been made thruout the refining industry in an effort to utilize selected stocks for the production of jet fuels. Basically, this would amount to determining the stability of many stocks, for example, straight run gasolines, distillates, kerosines, alkylate bottoms, and whatever else is available from refinery streams. Those with best heat stability, by laboratory test, could then be blended into jet fuels meeting required

specifications

To meet military supply and demand it often becomes necessary to maintain large supplies of jet fuels at various locations thruout the world. This fuel must be stable so it can be available for immediate use. While fuel can be kept relatively new in some areas by means of stock rotation, this may not be possible in others. This brings up the problem of stability in standing storage

Jet fuels can be made from a very broad hydrocarbon range, in fact, anywhere from 150°F to 600°F depending upon specifications. Fuels consist of certain quantities of straight run, catalytically cracked, and thermal cracked material. Stability-wise, straight run is most stable; thermal cracked least stable. Hence, most blends end up intermediate

Standing storage stability can usually be improved by the same general procedures being explored for thermal stability, that is, acid treatment and/or hydrogenation, where improvement is gained by removal of nitrogen and sulfur compounds, olefins and diolefins. Hence, the problem today is actually a corollary of thermal stability

Another problem encountered with jet fuels is due to contaminants and the consequent plugging of filter systems in the jet aircraft. Handling and distribution systems for jet fuels are usually underground. Fuel is pumped out of the tank by water displacement. Understandably, when fuel is moved, there is some agitation. If an additive is present, emulsification is possible. Also, there may be many contaminants such as rust, dirt, and water. The rate of settling, naturally is a function of viscosity and density. This is important since jet engines cannot tolerate too much foreign matter

For the most part, filtration systems can remove the contaminants. However, aside from foreign matter there is the case of insolubles formed from the fuel in the nature of gums. In this respect filterability behavior is apparently related to the character of the deposits formed. The more crystalline the deposit the less tendency to plug filters

Zabetakis et al (Ref 6) reported that mixts of JP-4 & UDMH (unsym-Dimethyl Hydrazine, See in this Vol, pp H203-R to H204-L) are insensitive to shock

Recent Review Articles on Jet Fuels.

Hibbard & Olson (Ref 10) discuss turbojet & ramjet fuels and their relation to fuel systems

Carney (Ref 11) reviews the props of "slush" hydrogen and points out its desirability as a space vehicle proplnt fuel because of wt savings on long-term storage. "Slush" hydrogen is a fluid mixt contg solid H₂ (by wt) 50% in liq H₂

F-O mixts (Flox) with light hydrocarbon (HC) fuels as rocket proplnts for upper-stage applications show the unique ability to provide high performance, space storability, hypergolicity, current availability, high d, and capability for both transpiration & regenerative cooling. Methane, (CH₄), gives the highest theoretical specific impulse of an HC fuel with Flox, but others show advantages in handling, bulk d, and regenerative & cooling capability. Blending of HC fuels may further improve space storability, fuel d, and fuel cooling ability. Methane is the best HC fuel with Flox in a transpiration-cooled engine or in a regeneratively cooled engine operating at supercritical pressure in the heat exchanger. 1-Butene and a eutectic blend of pentane & iso-pentane are the most promising fuels for regenerative cooled thrust chambers at subcritical pressures. An F/O ratio of ca 82/18 gives a sharp max specific impulse with methane as the fuel. Such high concns give hypergolicity (ignition on contact with fuel) almost like F alone. Data are given on ignition delay times using Flox with several light HC fuels and with H. All give satisfactory short ignition times for ambient sea-level start and during cold-altitude starts (Ref 12)

Lo (Ref 14) predicts that "triergol" or "tribrid" proplnts will provide max thrust in future rockets & space vehicles. These systems contain a metal (or metal oxide) in addn to H₂ as fuel. Examples are: O₃/Be/H₂, O₂/Be/H₂ & F₂/Li/H₂. They give a much greater specific impulse (See Isp in this Vol, p 163-R) than the corresponding "diergols" O₃/H₂, O₂/H₂ & F₂/H₂ by increasing the reaction temp. In practice, 3 tanks are required for the "triergol" system, but one of them can also serve as the combustion chamber

Zrelov (Ref 15) reviews the development of jet fuel technology with emphasis on production methods, composition, energy content, combustion

Table 1
Chemical and Physical Requirements and Test Methods

Requirements	Fuel			Test method	
	Grade JP-3 NATO symbol none	Grade JP-4 NATO symbol F-40	Grade JP-5 NATO symbol F-42	Federal test method standard No. 791	ASTM standards
Distillation:					
Initial boiling point.....	(1)	(1)	(1)	1001	D86
Fuel evaporated, 10 percent min. at.....	(1)	(1)	400° F. (204.4° C.)		
Fuel evaporated, 20 percent min. at.....	240° F. (115.6° C.)	290° F. (143.3° C.)	(1)		
Fuel evaporated, 50 percent min. at.....	350° F. (176.7° C.)	370° F. (187.8° C.)	(1)		
Fuel evaporated, 90 percent min. at.....	470° F. (243.3° C.)	470° F. (243.3° C.)	(1)		
End point, max.....	(1)	(1)	550° F. (287.8° C.)		
Percent evaporated, at 400° F. (204.4° C.).....	(1)	(1)			
Residue, vol. percent max.....	1½	1½	1½		
Distillation loss, vol. percent max.....	1½	1½	1½		
Gravity °API—min. (specific gravity, max.).....	50.0 (0.780)	45.0 (0.802)	36.0 (0.845)		
Gravity °API—max. (specific gravity, min.).....	60.0 (0.739)	57.0 (0.751)	48.0 (0.788)	401	D287
Existent gum, mg/100 ml, max.....	7	7	7	3302	D381
Potential gum, 16 hr. aging, mg/100 ml, max.....	14	14	14	3354	¹ D873
Sulfur, total, percent wt. max.....	0.4	0.4	0.4	5201	D1266
Mercaptan-sulfur, percent wt. max. ²	0.005	0.001	0.001	5204	D1219 or D1323
Reid vapor pressure, 100° F. psi, min. (gm/cm ² , min.).....	5.0 (351.6)	2.0 (140.6)		1201	D323
Reid vapor pressure, 100° F. psi, max. (gm/cm ² , max.).....	7.0 (492.2)	3.0 (210.9)		1201	D323
Freezing point, °F., max.....	-76° (-60° C.)	-76° (-60° C.)	-55° (-48° C.)	1411	D1477
Thermal value (see 3.2.2) Heat of combust. (lower or net) BTU/lb min. or Aniline-gravity product, min.....	5,250	5,250	4,500	3601 and 401	D611 and D287
Viscosity, centistokes at -30° F. (-34.4° C.), max.....			16.5	305	D445
Aromatics, vol. percent max.....	25.0	25.0	25.0	3703	D1319
Olefin, vol. percent max. ⁴	5.0	5.0	5.0	3703	D1319
Smoke point, mm min.....	(1)	(1)	19.0	2107	D1322
Explosiveness, percent max.....			50	1151	
Smoke volatility index, min. (see 3.2.3).....	52.0	52.0			
Copper strip corrosion, ASTM classification, max.....	No. 1	No. 1	No. 1		⁴ D130
Water reaction, vol. change, ml, max. (see 3.2.1).....	1	1	1	⁴ 3251	
Flash point, min.....			140° F. (60.0° C.)	1102	D93
Thermal stability.....		(1)	(1)	⁷ 3464	
Change in pressure drop in 5 hr, in. Hg.....		(1)	(1)	⁷ 3464	
Preheater deposit.....		(1)	(1)	⁷ 3464	

¹ To be reported — not limited
² Use steam jet method of D381 after oxidation
³ The mercaptan-sulfur determination may be waived at the option of the Inspector, if the fuel is considered "Doctor sweet" when tested in accordance with Method 5203 of Federal Test Method Standard No 791
⁴ May be reported as Bromine No when specified by the armed service for whom the material is approved

⁵ To be performed in accordance with paragraph titled "Tests at 212°F for Aircraft Engine Fuels" of ASTM D130-56. Earlier ASTM methods are not applicable since they require a dry sample
⁶ See 4.5.1 for exception to Method 3251
⁷ See 4.5.2 for test conditions under Method 3464

characteristics, scale formation & corrosion tendencies, volatility, thermal & oxidation stability, low temp props, and expln & fire hazards

Giacco (Ref 16) reviews solid proplnts for use in rockets

Koecker (Ref 17) reviews specification requirements of fuels for industrial gas turbines, conventional jet turbines (kerosine & gas oils), supersonic jet engines (JP-5 & JP-6), and future hypersonic jets (endothermic fuels)

Back (Ref 18) discusses proplnt toxicology, including toxicological effects on blood pressure, heart rate, and effects on autonormal & central nervous systems caused by N_2H_4 & derivs, penta- & decaboranes, F compds and Be compds

The handling of hazardous fuels & oxidizers is reviewed by Cloyd & Murphy (Ref 13). Data are presented on some highly reactive materials that have been studied in the search for fuels & oxidizers for space work, including liq H, pentaborane, F, ClF_3 , O_3 , N_2O_4 & N_2H_4 and its derivs. Both the hazards that restricted the use of these materials and the procedures by which they were handled & stored safely are described. Refs are given to work done by NASA & other investigators

Jet Fuel Patents.

The patent literature on jet fuels is very extensive. Some examples of patents granted on jet fuels are as follows: Fox & Britton (Ref 2) claim the incorporation of viscosity-index improvers in jet fuels to improve engine start-up & combustion efficiency over a wide range of temps. Materials claimed to be effective are ethyl glycol, Acryloid & Sanotex

Maisner (Ref 3) claims that incorporating nitroparaffin gel improves jet fuels

Burkhardt (Ref 4) proposes proplnts, for reaction engines, with compns which contain finely divided metals such as Zn, Cd, Mn, Fe, Pb & W

Thomas (Ref 5) claims systems useful for propulsion of rocket shells, JATO & airborne vehicles, consisting of a mixt of finely divided $MeNO_3$ with fuels which are nitro compds, such as NGu, Amm Picrate, etc. The addn of Al can modify burning characteristics. Binders are chlorinated polyphenyls or urea resins. The ingredients are milled on rolls just hot enough to soften the resin and then the mixt is pelleted

Beatty & Gluckstein (Ref 8) propose a mixt of Me_3Al 5-40 & Et_3Al 95-60% as a jet fuel igniter in jet aircraft engines

Becker (Ref 9) claims that wetting the combustor surface of a jet engine with di-methyl-silicone or $Si(OEt)_4$ prevents decompn of Be_2O_3 , on the engine walls, from Be contg fuels, such as a 4/1 mixt of trimethoxyboroxime-acetone

Because of the importance of these fuels, the Military Specifications for Jet Fuels, JP-3, JP-4 & JP-5 (Ref 4) are listed:

1. SCOPE

1.1 *Scope.* This specification covers fuel for aircraft turbine engines, ramjet engines, and rocket engines

1.2 *Classification.* Jet fuels shall be of the following grades, as specified:

Grade	NATO symbol	Description
JP-3	None	High vapor pressure type
JP-4	F-40	Low vapor pressure type (NATO description: wide-cut, gasoline type)
JP-5	F-42	High flash point, kerosene type

3. REQUIREMENTS

3.1 *Materials.* The fuel shall consist completely of hydrocarbon compounds, except as otherwise specified herein

3.2 *Chemical and physical requirements.* The chemical and physical requirements of the fuel shall conform to those listed in Table I, when tested in accordance with the applicable tests. Requirements contained herein are absolute and are not subject to correction for tolerance of test methods. However, if multiple determinations are made, average results shall be used

3.2.1 *Water reaction.* The fuel shall separate sharply from the water layer with only a few small bubbles around the periphery of the interface and no shreds of lace or film at the interface. Neither layer shall have changed in volume by more than 1 milliliter

3.2.2 *Heating value.* The heat of combustion determination may be waived at the option of the Inspector if the aniline-gravity product of the fuel is not less than the numerical values specified in Table I. The aniline-gravity product

is defined as the product of the gravity of the fuel in degrees API and the aniline point of the fuel in degrees Fahrenheit. If the aniline-gravity product of the fuel is less than the value specified, the fuel shall be accepted or rejected on the basis of the heat of combustion requirement

3.2.3 *Smoke volatility index.* The smoke volatility index shall be computed from the following equation:

$$\text{S.V.I.} = \text{S.P.} + [0.42 \times \text{volume percent boiling under } 400^{\circ}\text{F (204.4}^{\circ}\text{C)}]$$

where: S.V.I. = Smoke volatility index

S.P. = Smoke point in millimeters as determined by ASTM Method D1322

3.3 *Additives.* The additives listed herein may be used singly or in combination in amounts not to exceed those specified

3.3.1 *Antioxidants.* The following active inhibitors may be added separately or in combination to the fuel in total concentration not in excess of 8.4 pounds of inhibitor (not including weight of solvent) per 1000 barrels of fuel (9.1gm/100 US gal, 24mg/liter or 109 mg/imp gal) in order to prevent the formation of gum:

- a) 2,6-ditertiary butyl-4-methyl phenol
- b) N,N'-Dissecondary butyl paraphenylene-diamine
- c) 2,4-dimethyl-6-tertiary-butylphenol
- d) 2,6-ditertiary-butylphenol

3.3.2 *Metal deactivator.* A metal deactivator, N,N'-disalicylidene-1, 2-propane-diamine, or N,N'-disalicylidene 1,2-ethylene diamine may be added in an amount not to exceed 2 pounds of active ingredient per 1000 barrels of fuel (2.2gm/100 US gal, 5.8mg/liter or 26mg/imp gal)

3.3.3 *Corrosion inhibitor.* An approved corrosion inhibitor shall be added. The corrosion inhibitor furnished under this specification shall be product which has been approved under Specification MIL-I-25017. The amount added shall be listed in QPL-25017 (latest revision). The contractor shall maintain and, upon request, shall make available to the Government, evidence that all inhibitor products used are equal in every respect to the product qualified under Specification MIL-I-25017

3.4 *Workmanship.* The fuel shall be free

from undissolved water, sediment, and suspended matter. No substances of known dangerous toxicity under usual conditions of handling and use shall be added

4. QUALITY ASSURANCE PROVISIONS

4.1 *General.* All the tests required herein for the testing of fuel are classified as acceptance tests, for which necessary sampling techniques and methods of testing are specified in this section

4.2 *Inspection.* Unless otherwise specified by the procuring activity, inspection shall be in accordance with Federal Test Method Standard No 791, Method 9601

4.3 *Sampling.* Sampling shall be in accordance with ASTM Method D270 titled Sampling of Petroleum and Petroleum Products

4.3.1 When required, a 10-gallon sample, taken in accordance with ASTM Method D270, shall be forwarded to the laboratory designated by the procuring activity for testing as specified herein

4.4 *Examination of product.* Each container of fuel may be examined to determine conformance with this specification

4.5 *Test methods.* Tests as specified in 3.2 to determine conformance to chemical and physical requirements shall be conducted in accordance with Federal Test Method Standard No 791 or ASTM standards, using applicable methods as listed in Table I, except for the following

4.5.1 *Water reaction.* The water reaction test shall be conducted in accordance with Method 3251 of Federal Test Method Standard No 791, except that the water used for the test shall be a buffer solution consisting of 1.15g K₂HPO₄ (anhydrous, reagent grade) plus 0.46g KH₂PO₄ (anhydrous, reagent grade) per 100ml of distilled water. This solution shall have a pH of 7

4.5.2 *Thermal stability.* A manual, semi-automatic or automatic CFR fuel coker shall be used. The equipment and operating procedures shall be in strict accordance with Method 3464 of Federal Test Method Standard No 791. No deviation from this method is allowed

4.5.2.1 *Test conditions.* The test conditions, as applicable, shall be in accordance with Table II

Table II. *Thermal Stability Test Conditions*

	Grade JP-4	Grade JP-5
Preheater temperature (° F.).....	300	400
Filter temperature (° F.).....	400	500
Fuel flow (lb/hr).....	6	6
Test time (minutes).....	300	300

4.5.2.2 *Reported data.* The following data shall be reported:

a) Differential pressure in inches of mercury at 300 minutes or time to a differential pressure of 25 inches of mercury, whichever comes first

b) Preheater deposits at the end of the test

4.6 *Rejection and retest.* Material not conforming to the requirements of this specification shall be rejected. Rejected material shall not be resubmitted without furnishing full particulars concerning previous rejection and measures taken to overcome defects

6. NOTES

6.1 *Intended use.* The fuel covered by this specification is intended for use in aircraft turbine engines, ramjet engines, and rocket engines

6.3 *Precaution for mixing inhibitors.* To prevent any possible reaction between the concentrated forms of different corrosion inhibitors, the fuel supplier is cautioned not to commingle corrosion inhibitors prior to their addition to the fuels

written by J. ROTH

Refs: 1) Staff, C&EN 33, 4502 (24 Oct 1955)
 2) H.M. Fox & S.C. Britton, USP 2712726 (1955) & CA 49, 14298 (1956) 3) H. Maisner, USP 2712989 (1955) & Ordn 40, 476 (1955)
 4) W. Burkhardt, GerP 1021238 (1957) & CA 54, 10328 (1960) 5) C.A. Thomas, USP 2857258 (1958) & CA 53, 2580 (1959)
 6) M.J. Zabetakis et al, US BurMines RI 5635 (1960) & CA 54, 21763 (1960) 7) J. Kofenbach & T. Wasserbach, USP 2938779 (1960) & CA 54, 17851 (1960) 8) H.A. Beatty & M.E. Gluckstein, USP 2935839 (1960) & CA 54, 17889 (1960) 9) E. Becker, USP 2986876 (1961) & CA 55, 26448 (1961) 10) R.R.

Hibbard & W.I. Olson, CombustPropellenti-Nuovi, AttiConvMilan 1963, 217 (Engl) & CA 61, 15904 (1961) 11) R.R. Carney, Adv-CryogEng 9, 529 (1964) & CA 61, 13115 (1964) 12) A.I. Masters, JSpacecraftRockets 3 (6), 905 (1966) & CA 65, 10415 (1966) 13) D.R. Cloyd & W.J. Murphy, NASA Rept SP-5032 (1965), AEC Accession No 1727 & CA 65, 10415 (1966) 14) R. Lo, ChemIng-Tech 39 (15), 923 (1967) & CA 67, 92451 (1967) 15) V.N. Zrelow, ItogiNaukiTekhnol-OrgVeshchestv 1966, 5 (Publ 1968) & CA 72, 4854 (1970) 16) M. Giacco, QuadMerceol 7 (1), 63 (1968) (Ital) & CA 71, 83156 (1969) 17) M.H. Koecker, BrennChem 50 (4), 105 (1969) & CA 71, 5038u (1969) 18) K.C. Back, FedProcFedAmerSocExpBiol 29 (6), 2000 (1970) & CA 74, 11530 (1971) 19) US Specification MIL-T-5624J, "Turbine Fuel, Aviation, Grades JP-4 & JP-5" (Oct 1973)

Jet Perforators & Jet Tappers. Two commercial applications of the Shaped Charge Effect, marketed by the duPont Co, are described in the Blasters Handbook (Ref 1). The principle upon which they are based is as follows:

"The jet principle is simply the focusing of a greater than normal amount of the heat and energy of an explosion against a very small area. This is accomplished by using a high density, high strength explosive formed around a conical liner of metal or glass. When the explosive is detonated, the cone is collapsed and vaporized, forming a small high temperature jet containing particles of liner material moving at velocities of 10000 to 30000 feet per second. This strikes the target with such heat and force that the target simply flows radially from the point of impact leaving a deep nearly round hole. The principal factors that control the performance of jet charges are the type and weight of explosive, the diameter, material, and shape of the cone, and the stand-off or distance to the target"

DuPont *Jet Perforators* are explosive shaped charges specifically designed for perforating oil-well casing and penetrating far into the surrounding formation. These charges consist of a copper cone and explosive charge contained in plastic or metal bodies of different sizes depending upon the specific well to be perforated

When detonated, duPont Jet Perforators emit a high velocity jet of tiny copper fragments which penetrate the oil-well casing and formation leaving a deep, large diameter hole through which the oil can flow into the well.

Perforators for both "carrier" and "through-tubing" type oil well completions are available. In "carrier" type guns ranging from 2 5/8 to 5 inches OD, the Jet Perforators are threaded on a strand of "Primacord" and loaded into the gun, a steel tube which is sealed at both ends. The gun serves to control the standoff distance and prevents the well fluid from interfering with the jet formation. For through-tubing completion a smaller version of the carrier-type perforator can be supplied.

duPont pioneered the development of shaped charges for oil well use and these perforators and auxiliary devices have been used dependably for several years in the oil well industry.

duPont *Jet Tappers* are designed for tapping open hearth steel furnaces. They consist of a two ounce charge of a very powerful explosive in a plastic case with a copper cone. The charge is contained in a bullet-shaped insulating jacket. When the Jet Tapper is assembled for use, a special high temperature Jet Tapper Blasting Cap is threaded through a hollow fiberboard pole eight feet in length, the cap is inserted in the charge, and the insulating jacket is slipped onto the end of the loading pole.

The explosive used in the Jet Tapper is relatively insensitive to impact, friction, heat,

and other causes of accidental detonation as compared to most commercial explosives. If heated to a high enough temperature it will burn without detonating. In one test a case of Jet Tappers was completely burned in a bonfire of kerosene-soaked wood without detonating. In another test, six Jet Tappers were laid side by side between steel plates and a 150 pound weight was dropped nine feet onto the upper plate. The charges were completely crushed but there was no detonation.

The special Jet Tapper Blasting Caps have been designed to withstand prolonged exposure to high temperatures. Experience has shown that they will stay in a hot tap hole for from three to eight minutes before detonating when they are used as part of the Jet Tapper assembly.

The only phase of open hearth furnace tapping, as it is now practiced, that is replaced by the use of the Jet Tapper is the lancing operation or the burning through of the tap hole facing with an oxygen lance. The tap hole must be dug out to the facing as is the present practice. The Jet Tapper is then slid into the tap hole until the nose of the insulating jacket touches the facing, as shown in the diagram. The person placing the Jet Tapper then retires to the firing point and the Tapper is detonated.

Field experience indicates that over-all a 90 to 95 percent average of successful taps is being obtained using duPont Jet Tappers, and that the unsuccessful taps are very easy to lance. The unsuccessful taps can usually be traced to: (1)

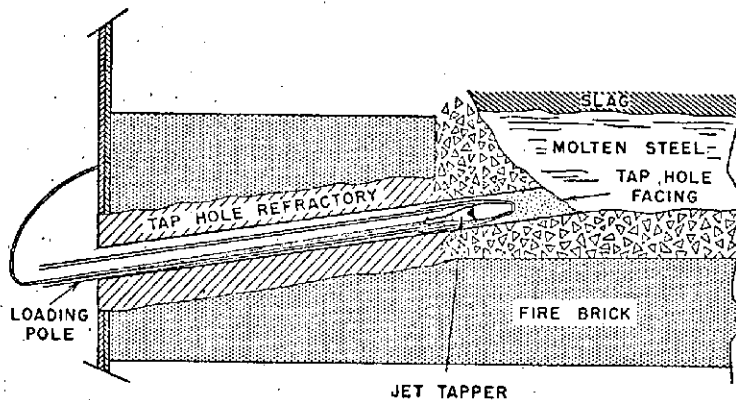

Cross Section of Open Hearth Furnace Tap Hole Showing Jet Tapper in Position for Firing

a poorly dug out tap hole, (2) steel which has leaked through the facing, or (3) excessively high furnace bottoms

The use of Jet Tappers has proved to have the following advantages over the conventional method of tapping:

(1) No one is at the runner when the metal flow starts

(2) The danger of burns from faulty connections on oxygen lances is eliminated

(3) Heats can be tapped at exactly the desired time, avoiding off-specification steel resulting from loss of volatile additives during delayed or slow taps

(4) Taps start out at full flow rate, thus reducing the over-all tapping time and ladle skull

(5) Tap hole maintenance is reduced and perfect alignment of the tap hole is insured

(6) The need for bars to knock down ridges in front of the tap hole is practically eliminated

Because of these major advantages, it is expected that Jet Tappers will eventually replace the oxygen lance method of tapping entirely. In fact they have already been adopted for more than two-thirds of all the open hearth furnaces in this country

Cook (Ref 2) states that further commercial use of the Jet Effect is hindered by the high cost of well-made lined-cavity charges

Refs: 1) *Blasters Hdb* (1958), pp 91-96 2) Cook (1958) p 259

JET PROPULSION

Introduction. "In the absence of all contact with an external solid, a prime mover placed in a fluid of finite or even zero density can propel itself by ejecting a fluid or solid mass toward the rear. By convention we say that this mover is propelled by **jet propulsion**, although the propulsive thrust really results from the effects of pressure and friction exerted on the wall of the hollow interior of the mover by the solids or fluids moving in the interior toward the exhaust nozzle"

"In all jet propulsion engines, just as for all propulsion of thermal origin, the source of available energy is an exothermic chemical transformation of solids, liquids, or gases, *carried on board* and called propellants. For

brevity, we include all these propellants under the single term *fuel*"

"For propulsion in the atmosphere, where ambient air is available, this air may be inducted by the jet engine in order to participate essentially in the chemical transformation of the fuel: the engine is then properly called an air flow jet engine in contrast to the rocket, which does not use any air and is the only jet engine which can be used for propulsion in vacuum"

These quotations are from Sec B of a classic book on Jet Propulsion entitled *Jet Propulsion Engines* (Ref 1). The contents of this excellent treatise are summarized in its preface:

"This volume considers those principles and problems encountered in combining components to form a complete engine. It relies heavily upon the other volumes which deal with basic principles or principles and problems related to components of an engine

Section A gives a concise history of the development of rockets and air flow jet engines. Section B gives definitions of thrust and various efficiencies and derives relationships for the performance of the different jet propulsion systems. Section C gives the performance analysis of turbojets based on the internal solution of matching the compressor, combustor, turbine, and nozzle. It includes a discussion of off-design performance and describes the problems of control and testing which are unique to a complete unit. Section D treats the turboprop in a somewhat similar manner. It gives the logic for interest in a turboprop and discusses the additional complications. Section E is devoted to the ramjet, its performance, controls, and methods of testing. Section F discusses the wave engines in general, and in particular the pulse jet and the complex. Section G treats the liquid rocket engine, from the consideration of appropriate fuels (both monopropellant and bipropellant) to the designing and testing of the motor. Section H gives a similar treatment for solid propelled rockets, with special stress on the stability and characteristics of burning. The possibility of a variety of hybrid engines, part rocket, part turbine, or more generally part jet and part rotating machinery, is introduced in Sections I and J which treat two such cases—the ram-rocket and the jet rotor.

Each section derives the possible performance and outlines the possible use of these engines. Section K deals with the problems in making a nuclear jet power plant suitable for aircraft: It gives the theory related to the shielding, heat transfer, and the production and control of a small lightweight reactor. The final section does not quite give a peek into the future, but it gives a systematic procedure for exploring the many possibilities of the types of jet engines”

In what follows we will briefly describe the various types of jet propulsion systems and give a list of references to the voluminous literature that has appeared on this subject since the publication of the above book (1959). The reader is also referred to the following Encyclopedia articles: Combustion; Hypergolic Propellants; Ignition; Propellants and Rockets

In general, in all jet propulsion engines, the driving energy source is the exothermic chemical transformation of solids, liquids or gases (propellants) carried on board the engine

For propulsion in the atmosphere, where ambient air is available, this air may be induced by the jet engine in order to participate essentially in the chemical transformation of the fuel: the engine is then properly called an air flow jet engine (in Fig 1 the *Turboprop*, *Turbojet*, *Ramjet* & *Pulse Jet* are examples of air flow jet engines) in contrast to the rocket, which does not use any air and is the only jet engine which can be used for propulsion in vacuum

A flow of ambient air may also be inducted exclusively for augmenting the thrust by increasing the mass flow of the discharged gases: thus we can conceive of an air flow jet engine with two flows, an example of which is a *turbojet* with a ducted fan

Whereas the internal flow of a rocket is usually continuous, and even quasi-steady, that of an air flow jet engine can be continuous or discontinuous, ie intermittent. The machines which work on the internal flow of a jet engine and have a continuous flow require purely rotating machines, ie turbomachines; the engine is called a *turbojet*

In the *turboprop*, the exothermic reaction not only drives the propeller but the exhaust

of the reaction products through the nozzle contributes to the total thrust

If compression and expansion of the internal flow is not produced by rotating or reciprocating machinery but by oscillatory motion of the flow, ie wave motion, the jet engine is called a *pulse jet*

If, in a continuous flow jet, only the compression resulting from ram effect in the inlet diffuser is utilized, the compression and expansion machinery is eliminated, and the turbojet becomes a *ramjet*

Types of Jet Propulsion Engines. The basic jet propulsion engines are illustrated schematically in Fig 1:

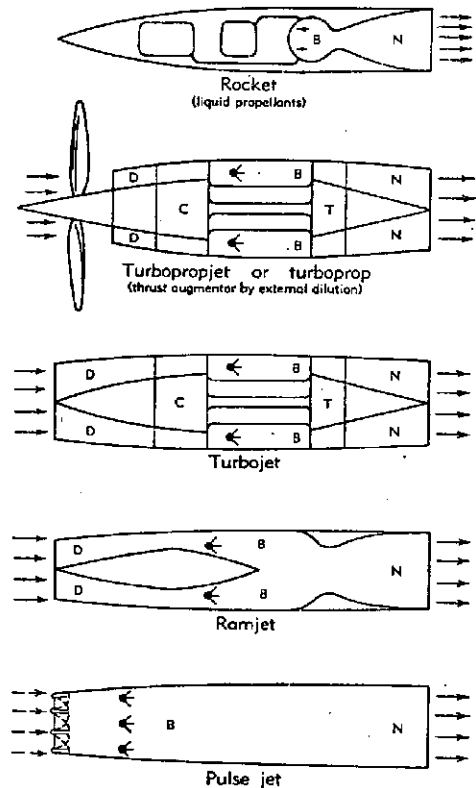

Fig 1. Types of Jet Propulsion Engines

In these diagrams, D is the intake duct, C is the compressor, B is the burner, T is the turbine and N is the exhaust nozzle. The mode of operation of these engines will be described in the next section

Modes of Operation of Various Jet Engines.

1) *Rockets*. As clearly stated a rocket is differentiated from a fluid flow engine in that a rocket generates its thrust entirely from reacting material carried within it, while a fluid flow system takes in material (air) from the outside. The subject of rockets will be described in more detail under *Rockets* and some material pertaining to rockets has already been described under *Hypergolic Propellants* and under *Ignition*. Here we just outline the type of rockets in use or under development:

- 1) Solid propellant rocket motor
 - a) Constant volume combustion
 - b) Constant pressure combustion
 - (i) Restricted burning
 - (ii) Unrestricted burning
- 2) Liquid propellant rocket engine
 - a) Gas pressure feed system
 - b) Turbopump feed system
- 3) Gas or vapor propellant rocket engine
- 4) Ionic rockets

Turboprop & Turbojet. The basic principles involved in generating the potential power of a turbojet and a turboprop are identical. They each have a compressor, a burner, and a turbine which runs the compressor. This common part of each produces energy in the form of a hot gas at a high pressure. The only difference in the engines is the manner in which the available energy is converted to useful thrust. In a turbojet the energy is converted to thrust by expanding the gases through a nozzle to form a jet at high velocity. By directing this jet backward the reaction gives a forward component of thrust. In a turboprop, part of the potential energy is removed by additional turbine stages that drive a propeller. Any residual energy is then used to produce a jet stream similar to that of a turbojet, but because of the lower energy level the jet velocity is much lower (See Fig 2 below)

For convenience of thought in comparing the two engines, the part that is common to the turbojet and the turboprop is usually referred to as the hot gas generator, or power generator, and the means for converting the energy to thrust power is called the propulsive system. The hot gas generator is analogous to the steam boiler on a steam engine, in that

each produces available energy stored in a gaseous medium at a high temperature and pressure

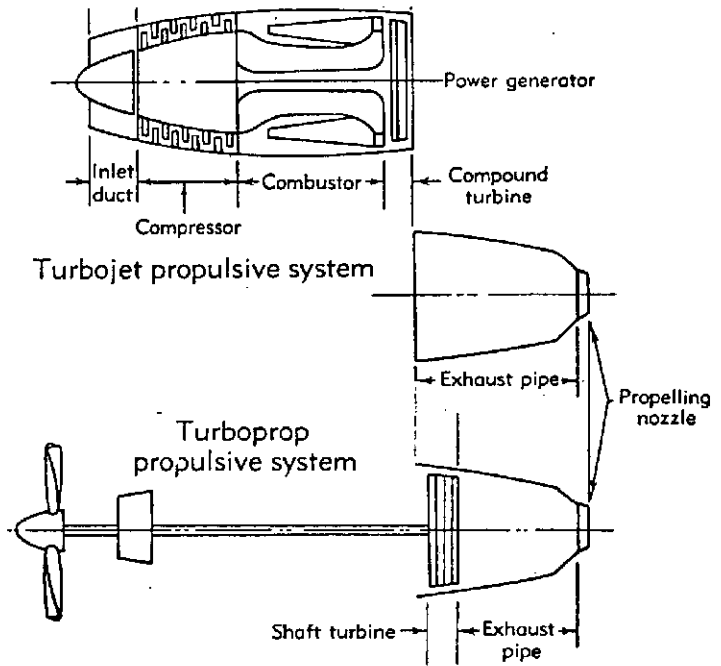

Fig 2. Comparison of Turbojet & Turboprop Engines

Note: The power generator system for the turboprop is essentially the same as in the turbojet

The advantages of a turboprop are in its greater efficiency, ie more of the gas generator energy is converted into useful work than in the turbojet. Its main disadvantages lie in the heavier and more cumbersome machinery that it requires

Ramjet. We quote from Sect E of Ref 1:

"The ramjet engine, in common with all jet engines, produces propulsive power by increasing the momentum of the working fluid through some form of heat release so that the momentum of the exiting jet exceeds the momentum of the entering air stream. In contrast to other air-breathing jet engines the working cycle is accomplished without mechanical compression of the working fluid and without intermittent semiclosed combustion cycles;

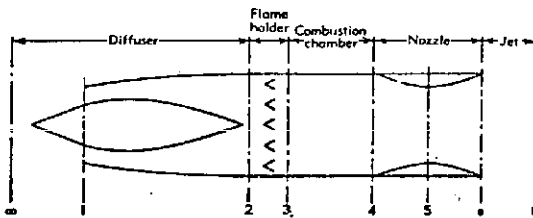

Fig 3. Schematic of ramjet engine

consequently the ramjet is mechanically the least complicated air-breathing engine yet devised

The basic elements of the engine can be represented schematically as in Fig 3. The charge air is inducted to the combustion or heat release chamber through a diffuser, so-called because the entering air stream is generally decelerated from the forward speed of the engine to a lower combustion entrance velocity. In engines employing liquid or gaseous fuels for the energy addition to the charge air, the fuel is injected through orifices or nozzles at some point in the diffuser process. The location of the point of fuel injection depends upon the desired degree of atomization and vaporization of the fuel and the desired mixture pattern of the fuel and charge air at the entrance to the combustion chamber

At the end of the diffuser passage is located a flame holder, a turbulence-generating device offering shelter to the subsequent combustion flame. The fuel-air mixture entering the combustion chamber is ignited in the sheltered regions of the flame holder by some independent ignition source. In most engines this ignitor is only required to function at the onset of combustion, the combustion process being self-propagating for continuous operation

The combustion of the fuel-air mixture is ideally completed in the combustion chamber, normally a constant area passage. (In ramjets utilizing an external heat source such as a nuclear reactor, the fuel-injection, flame-holding combustion process is replaced by a heat exchanger from which the uncontaminated charge air is discharged at an elevated temperature)

The products of combustion leaving the combustion chamber are, in general, at a

higher pressure than the free stream air surrounding the engine. The exhaust nozzle is used to expand the flow and thereby to convert the pressure into velocity. The flow velocities after combustion are subsonic; hence an initial contraction of the flow area is necessary. This contraction must be sufficient to either reduce the internal pressure to the ambient value or to accelerate the internal flow to sonic velocity. At low design flight speeds, ambient pressure is achieved with unchoked flow and the nozzle terminates with the convergence. At high flight speeds the internal flow chokes at pressures above ambient and for maximum thrust realization a diverging passage is added downstream of the throat in which the flow continues to expand to supersonic velocity until ambient pressure is attained"

The fundamental limitation of the ramjet is its requirement of sufficiently rapid motion for the engine to become operative. "The engine will not yield an internal thrust force until the flight speed is high enough to produce a diffuser pressure rise that is sufficiently great to exceed the pressure losses in the flame holder, combustion chamber, and exhaust nozzle. An effective propulsive thrust force will not be obtained until the flight speed is enough greater than this minimum value for the internal thrust to compensate the drag directly chargeable to the engine installation. A yet higher speed must be obtained before the propulsive thrust is great enough to overcome the drag of the vehicle in which the engine is installed and thus to qualify the engine as a useful propulsive device

The minimum flight speed at which the ramjet can qualify as a propulsion system for aircraft depends upon the degree to which the internal pressure losses and the installation drag are minimized and upon the drag of the propelled airframe. In general it has been found that the minimum speed application of the ramjet is not less than about 400 mph. (This speed is the relative speed of the engine and not necessarily of the airframe. Thus, ramjet engines, tip-mounted on the rotors of helicopters, have proved to be adequate propulsive devices at zero forward airplane speed.) The efficiency of the engine is very low at these minimum speeds, however, and applications of

interest at subsonic speeds are confined to installations in which the attractions of light weight, mechanical simplicity, and low cost outweigh considerations of fuel consumption.

As the engine flight speed is increased the thrust increases as a function of the square of the flight speed in the same order as the airframe drag. Thus a ramjet engine, properly designed, is capable of producing the very high thrusts necessary for supersonic propulsion. The engine efficiency, and hence the specific fuel consumption, ideally improve as flight speed increases so that the principal range of application of the ramjet as a competitive power plant appears to lie in the propulsion of supersonic vehicles.

The inability of the engine to produce a useful propulsive force at zero or low flight speeds necessitates the use of an auxiliary power plant to initially accelerate the vehicle to the required take-over speed of the ramjet. Such auxiliary power is also required for controlled landing of the vehicle. As a consequence the ramjet engine is not well-suited for conventional aircraft applications (with the exception of the helicopter) and the principal application of the engine appears to be further restricted to missiles or other similar vehicles of a one-flight expendable nature."

Pulse Jet. We quote from Sect F, Chapter 4 of Ref 1:

"In its standard form the pulse jet consists of a shaped tube fitted with flow-check valves at the front end (Fig 4). The air flowing into the engine through the valves is mixed with a continuously sprayed fuel. The mixture is then fired. As a result of the pressure rise which accompanies the explosion, the inlet valves close and the exhaust gases are forced out through the tailpipe. Expansion waves which are generated in the discharge reduce the pressure behind the check valves until they open again to admit a fresh charge of air, and the cycle is repeated. A spark is needed only for starting; once a regular cycle is established, each fresh charge of mixture is ignited by the hot gases from the preceding explosion and operation proceeds without further use of the spark plug.

Despite the mechanical simplicity of the pulse jet, a great deal of information is still lacking about such important details as its operating cycle as the flow behavior through the intake valves and at the discharge end, the timing and mechanism of ignition, and, above all, the process of combustion. This lack of basic information has necessitated the use of quite arbitrary assumptions in all theoretical investigations of the pulse jet cycle"

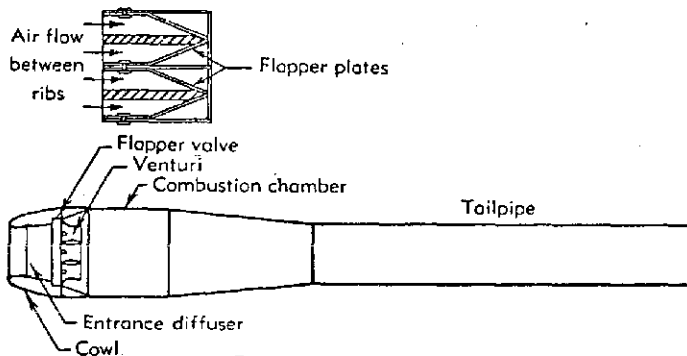

Fig 4

Comparison of Performance Parameters of Jet Engines. The excellent diagram below is taken from pp 96 & 97 of Ref 1

Propulsion method	Picture	Mass of air or gas handled \dot{m}	Thrust F proportional to mass handled and change in momentum	Efficiency η of converting fuel energy to mechanical energy	Propulsive efficiency η_{pr}	Over-all efficiency	Relative frontal area (drag)	Relative weight of fuel for a given duration	Probable range of maximum flight speeds
Rocket									1. Above 600 mph 2. For aid in take-off 3. For flying bombs
Ramjet									1. Above 500 mph 2. For flying bombs
Pulse jet									1. 300 to 600 mph 2. For flying bombs
Turbojet									400 to 1500 mph
Turboprop									300 to 600 mph
Supercharged reciprocating engine with geared propeller and exhaust jet									150 to 450 mph

Note that overall efficiency of all the above engines is primarily controlled by the cycle fuel efficiency & the propulsive efficiency

Written by J. ROTH

Refs: 1) O.E. Lancaster, Ed, "High Speed Aerodynamics & Jet Propulsion," Vol XII, "Jet Propulsion Engines," Princeton, NJ, Princeton Univ Press (1959) 2) N.A. Ragozin, "Jet Propulsion Fuels," Pergamon Press, NY (1961) 3) R.E. Weich, Jr & R.F. Strauss, "Fundamentals of Rocket Propulsion," Reinhold, NY (1960) & CA 56, 13152 (1962) 4) M. Barrere et al, "Rocket Propulsion," Elsevier Pub Co, Amsterdam (1960) & CA 58, 7780 (1963) 5) S.S. Penner, "Chemical Rocket Propulsion & Combustion Research," Gordon & Breach, NY (1962) & CA 58, 5447 (1963) 6) W.H. Jones, "Recent advances in the chemistry of liquid & solid propellants," Combust Propellenti Nuovi, AttiConv, Milan, 1963, 249 (Pub 1964) & CA 62, 1505 (1965) 7) M. Barrere, "Research in the field of chemical propulsion," NASA Accession No

- N65-21452**, Rept No **CPIA-67**, 4-6 (1964). From *SciTechAerospRept* 3 (11), 1889 (1965) & **CA 65**, 12054 (1966) 8) D.L. Turcotte, "Space Propulsion," Blaisdell, NY (1965) & **CA 65**, 13449 (1966) 9) L.E. Maher, "Aerospace applications of rocket engines," *JBrit-InterplanetSoc* 19 (11), 490 (1964) 10) J. Szabo, "Principles & physical possibilities of space travel," *NedTijdschrNatuurk* 32 (5-6), 191 (1966) & **CA 66**, 6747K (1967) 11) D. Genthe, "Oxy compounds of fluorine & their applicability in rocket propulsion," NASA Accession No **N66-12486**, Rept No **DLR-FB-65-29**; avail CFSTI (1965). From *SciTechAerospRept* 4 (3), 480 (1966) & **CA 66**, 97055 (1967) 12) E. Ungerer, "Problem of propulsion by hot-water jets," NASA Accession No **N66-38349**, Rept No **DLR-FB-66-43**, avail CFSTI (1966) (in Ger). From *SciTechAerospRept* 4 (23), 4611 (1966) & **CA 66**, 10638 (1967) 13) Ya. B. Zeldovich et al, "Impulse of Reactive Force of Solid Propellant Rockets," (AD-632233), CFSTI, Springfield, VA (1966) & **CA 67**, 4513 (1967) 14) C.A. Vansant, "Aeroenergy; a new frontier," IAA Accession No **A66-3443**; avail AIAA (1966). From *Intern Aerospace Abstr* 6 (18), 3162 (1966) & **CA 67**, 23624 (1967) 15) G.A. Marxman, "Boundary-layer combustion in propulsion," *SympCombust* 11, 269 (1966; pub 1967) & **CA 68**, 41776 (1968) 16) R. Cockburn, "Rocket propulsion & space research," *Endeavour* 26 (97), 21 (1967) & **CA 66**, 77884 (1967) 17) L.S. Billman, Ed, "Advanced Propulsion Concepts," Gordon & Breach, NY (1967) & **CA 70**, 21461 (1969) 18) W.H.T. Loh, Editor, "Jet Rocket; Nuclear, Ion and Electric Propulsion: Theory and Design," *Applied Physics & Engineering*, Vol 7, Springer-Verlag (1968) 19) R.W. Jenkins & R.E. Elbel, "Performance potential of the bipropellant pulsed turbine space power system," *AdvEnergyConservEng, PapCritSumIntersocEnergyConversEngCont* 1967, 493, *AmSocMechEng*, NY & **CA 71**, 103725 (1969)
- c 100 BC Hero built a steam jet engine, called an *aeolipile*, in Alexandria, Egypt
 1232 Chinese used rockets to frighten enemy soldiers
 c 1500 Leonardo da Vinci proposed using upward movement of hot gas in fireplace chimney to turn a spit for cooking meat
 1629 Italian engineer Giovanni Branca built a crude steam turbine which drove a machine
 1678 Ferdinand Verbiest, a Jesuit in China, built a model carriage, using a jet of steam for power
 1687 Sir Isaac Newton stated the law of action and reaction
 1791 John Barber, an Englishman, patented a gas turbine that was an ancestor of the turbojet
 1908 Rene Lorin, a French engineer, made detailed drawings of a proposed ramjet engine
 1926 A. A. Griffith in Great Britain described theories of using gas turbines in aircraft
 1930 Frank Whittle of Great Britain patented design for a jet-aircraft engine
 1939 Heinkel Company in Germany built and flew the first jet-engine airplane
 1941 First successful turbojet airplane was flown in Great Britain. Engine designed by Whittle
 1944 First jet-propelled fighters used in WWII by Germans
 1947 First supersonic (faster than speed of sound) rocket-powered airplane was flown in the US by Charles Yeager
 1952 First scheduled airline flights by jet transports begun by Great Britain
 1955 First jet-engined convertiplane that takes off and lands straight up and down was tested in the US
 1957 High-energy fuels that increase jet ranges almost 50% were put into commercial production
 1958 First commercial jet passenger service between New York and London
 1960 Turbofan engines using fans for added thrust in place of afterburners came into commercial use

Jet Propulsion, History of. Early uses of the principles of jet propulsion and their evolution into modern jet aircraft are summarized in the tabulation below (Ref 2)

More detailed, fairly recent historical data on Air Flow Jet Engines are given in Ref 1, pp 29-53 (including 201 refs). The subjects covered in this excellent review are: *Piston*

Engine Jet Development; Turbojet Development; Ramjet Development; Development of Intermittent Jets; Other Forms of Air Flow Jet

A.D. Baxter, the author of this chapt of Ref 1 summarizes his review as follows:

"In conclusion, it may be observed that in the ten years following the 1939-1945 war, air flow jet engines supplanted piston engines in almost all high performance military aircraft, they made large inroads on the civil aviation field including the first regular turbojet passenger service in 1951, they made supersonic flight a commonplace, and finally they doubled the world air speed record"

Refs: 1) O.E. Lancaster, Edit, Jet Propulsion Engines, Princeton Univ Press (1959) Chapt 3 (by A.D. Baxter) 2) S.S. Stillwell, World Book Encyclopedia Vol II (1965) p 92-R

Jet Propulsion Unit "Decipede". A jet propulsion unit, which develops 1000 pounds thrust for 43 secs, was developed at the request of the Engineer Board Field Station. The unit is the motor power of an amphibious "Snake" employed in Marine & Army land operations. It burns ten 8½-inch diam grains of CP 401 proplnt simultaneously in a single motor tube. The proplnt gases come out of five pairs of nozzles spaced along the side of the motor tube. This unit, informally known as the "Decipede" was developed to the point of satisfactory operation

Ref: Central Res Lab, Monsanto Chemical Co, "The 'Decipede', a 1000 Pound Thrust, 43 Second Burning Time, Jet Propulsion Unit", OSRD 5704 (Nov 1945)

Jet Pumps are devices for transferring liquids from one point to another, using the fluid pressure as an operating medium. They also may be used for mixing liquids. Two types of jet pumps are of interest to the chemical engineer. One of them is the *ejector* (siphon, exhaustor or eductor), which is designed for use in operations where the head pumped is low and is less than the head of the fluid used for pumping by pressure. Another device is the *injector*. It is operated by steam and used

for boiler feed or similar services, in which the fluid being pumped is discharged into a space under the same pressure as that of the steam that is used to operate the injector
Ref: Perry (1950), 1439; (1963), pp 5-17 & 6-13

Jewel Powder. One of the early American smokeless proplnts of the Ballistite type (See Vol 2 of Encycl, p B8-L) proposed by Monroe
Ref: Daniel (1902), pp 387 & 447

Jewler Explosives. See Ievler Explosives in this Vol, p 14-R

Johnite Explosives. See Jahnite Powders in this Vol

Johnson & Alexander Priming Composition. These inventors were issued British patents in 1856-57 for a priming compn containing amorphous P 8.3 & lead nitrate, $[\text{Pb}(\text{NO}_3)_2]$, 91.7%
Ref: Daniel (1902), pp 8 & 388

Jolt & Jumble Tests. These tests have been used for many years to establish the safety and general ruggedness of fuze & booster designs under the application of repeated shocks in several directions. Both tests were designed originally as a simulation of shocks received during transportation of US Army caissons over rough terrain. In present applications the tests are intended to accurately represent actual conditions which may be encountered in transportation, handling or use of fuzes. They are rather a deliberate exaggeration of severe conditions to which an item might be exposed during transportation or use. As a result of the long use of these tests, much information has been accumulated regarding the behavior of a wide variety of fuzes in the tests. Although it is not a requirement that the fuzes be operable afterward, some fuze designers do require that their fuzes remain operable. In such cases, operability is judged by examination only, although firings may be

conducted in addn where considered appropriate by the designer

Jolt Test. It consists of assembling the test item into the end of a pivoted arm which under cam action falls by gravity thru 4 inches on a heavy bed plate, giving a considerable jolt. Each item is tested for 1750 jolts, at a std speed of 35 jars per min, in each of three positions: vertically up, vertically down & horizontal. All fuze expl elements shall be present in the fuze during the test. The jolt testing machine is shown on US Ordnance Corps Drawing 81-3-30. It takes 50 mins to test a sample in each of the three positions, or ca 2½ hrs for a complete test

The criteria by which samples are judged to have withstood this test are: 1) no element shall explode and 2) no parts shall be broken, deformed, be displaced, come apart, or arm in such a manner as to make the assembly unsafe to handle, or dangerous to use. Break-down & inspection, together with engineering judgment, are usually the basis for the decision

Jumble Test. It consists of placing the test item in a std steel fixture which completely encloses the item, then putting the fixture inside a rectangular hardwood maple box, which is rotated about its diagonal corners. The fixture containing the item rolls inside the box, receiving bumps at random. The box rotates at 35 rpm and the test consists of 3600 revolutions. It takes about 2½ hrs. The jumble test machine is shown on US Ordnance Corps Drawing 81-3-35. The criteria for passing the test are the same as given under Jolt Test

Note: Particular care should be exercised in handling test items after the jolt & jumble tests; a safety shield should be used. The articles may become armed or the expl chge may have sifted out. In these cases, a slight jar may initiate a defective fuze. The jolt test is always run first. Total time for both tests is ca 5½ hrs

Refs: 1) Ohart (1946), pp 135-37 2) US Military Standard, "Fuze and Fuze Components, Environmental and Performance Tests for", MIL-STD-331 (Jan 1966) with Change Notice 2 (Dec 1967)

Jones Detonator Loader. An automatic loading machine developed in 1943 by R.A. Jones of Ohio in cooperation with engineers at Picatinny Arsenal. This machine proved to be a great success during WWII and saved about 175000 man hours per year

Ref: E. Cox, ArmyOrdn 29, No 152, 282-84 (1945)

Jones Blasting Explosives. Jones patented the following compn: chlorates such as NaClO_3 are used with finely divided carbonaceous substances & the o-isomer of nitrotoluene, which keeps the mixt plastic. The chlorate may be mixed with a powdered carbonaceous absorbent material such as sawdust & a liq mixt of o-nitrotoluene & melted TNT

Ref: L.T.W. Jones, USP 1820567 & 1820568 (1931) & CA 25, 5771 (1931)

Jones Dynamite. An Australian Dynamite consisting of NG 30-35% absorbed by a mixt of Ca sulfate & kieselguhr 70-65%

Ref: Daniel (1902), p 388

Jones Smokeless Powder. One of the first progressive-burning smokeless proplnts patented in 1897 in Austria. It was prepd by coating grains of proplnt with a thin layer of resin, fatty acids or carnauba wax. About ½ part of coating per 100 parts smokeless proplnt was used. This method retarded combustion, especially at the start, and allowed attainment of a fairly progressive increase in the rate of burning without increasing the pressure in the gun barrel

Ref: Daniel (1902), p 388

Jordan Pulping Machine. It is used in preparing cotton for nitration. The machine operates on the centrifugal principle, by means of which the entering cotton is thrown from the large end of the beater to the small tapered end, and thence to a storage tank above the machine. The more efficient way to operate these units is to have them adjusted in such a manner that

the cotton is given successive cuts. In other words, the first treatment in the Jordan machine will give only a fairly coarse cut, the next a little finer, and so on, until the cotton has finally been pulped to the necessary degree of fineness

Jouguet, (Jacques-Charles) Émile (1871–1943). French physicist, general inspector of mines and professor of mechanics École des Mine, École Polytechnique, member French Academy of Science (1930). He was the author of "Mécanique des Explosifs" (1917) and conducted research on wave diffusion, movement of fluids, explosives; and fundamental work on the hydrodynamic theory of detonation. His name is associated with that of Chapman in the famous Chapman-Jouguet condition. In their honor parameters of a steady detonation wave are usually designated by the subscript CJ

See Detonation, Chapman-Jouguet in Vol 4 of Encycl, pp D230–37 and Jouguet's Rule, p D607-L

Ref: A.G. Debus, Edit, "World Who's Who in Science", Marquis Co, Chicago (1968), p 896-L

Jouguet's Rule. See in Vol 4 of Encycl, p D607-L

JP, JPH and JPN Propellants. See under Ballistite in Vol 2 of Encycl, p B9-R

Judson Dynamite or Powders. American expls patented by E. Judson in 1876 and manufd in Drakesville, NJ. These expls were, in fact, a combination of Black Powder & NG and were much more powerful than straight BlkPdr, although some of them contained only a small amt of NG. For example, one compn contained: NG 5, NaNO₃ 64, sulfur 16 & bituminous coal (cannel coal) 15%. Judson's expls were also called RRP (meaning Railroad Powders)

Judson's patent may have been pre-dated by Nobel's patent (Ref 1) for a mixt of NG & Black Powder
Refs: 1) A. Nobel, BritP 2359 (1864) quoted

in Cook (1958), p 8 2) Daniel (1902), p 389 3) Marshall 1 (1917), p 363 4) Davis (1943), p 334 5) Giua, Trattato VI (1) (1959), p 340

Juinite. See Ethylenebisurethane and Derivatives in Vol 6 of Encycl, p E234-L

Jump Firing Test. In tabulating the elevations & azimuths required to obtain a given range and deflection of a gun, account is taken of the fact that usually the direction of the target to the trajectory at the origin differs from that of the axis of the bore of the gun before it is fired. This difference in direction is called *jump*. The jump may be in any direction, but as a matter of convenience it is described by two coordinates, vertical & horizontal

The jump firing test is described in US Ordnance Proof Manual 40-11 (1942)

Jumping Detonation. See Detonation, Jumping in Vol 4 of Encycl, p D421-L

Junk Test. See Bergmann-Junk Test in Vol 2 of Encycl, p B102-R

Juno 1. A space research vehicle which is a four-stage version of the Juniper C (qv). The first stage burns a high energy hydrazine fuel, called Hydyne (developed by the North American Aviation Co), and liq oxygen. The 2nd, 3rd & 4th stage thrusts are solid propellants. Characteristics of Juno 1 are length 68.6', diam 70", wt loaded 64000 lbs, useful pay load 10–15 lbs, altitude 2000 miles, and velocity 19000 miles/hr. The rocket was used to launch several of the Explorer satellites
Ref: F.I. Ordway & R.C. Wakefield, "International Missile and Spacecraft Guide", McGraw-Hill, NY (1960), United States of America, pp 73–74

Juno 2. A space research vehicle having 4 stages of thrust. The first stage burns a hydrocarbon, RP-1, and liq oxygen. The other three

stages burn solid propellants. Length of the rocket is 76', diam 105", wt loaded 121000 lbs, and pay load 13-80 lbs. The vehicle was used to orbit Explorer 7

Ref: F.I. Ordway & R.C. Wakefield, "International Missile and Spacecraft Guide", McGraw-Hill, NY (1960), United States of America, p 74

Juniper C. A space research vehicle having 3 stages of thrust. The first stage burns either liq oxygen & ethyl alcohol or liq oxygen & Hydryne (See under Juno 1, above). The second & third stages are solid proplnts. The rocket is 66.6' in length, diam 70", wt loaded 64200 lbs, pay load 300 lbs, range 1600 miles, altitude 400 miles, and velocity 14700 miles/hr
 Ref: F.I. Ordway & R.C. Wakeford, "International Missile and Spacecraft Guide", McGraw-Hill, NY (1960), United States of America, pp 44-45

Jupiter Dynamite or Powder. One of the older American type No 2 Dynamites, similar in compn to Neptune or Vulcan powders
 Ref: Daniel (1902), p 389

Justice Powder. Justice patented in 1888 an expl mixt consisting of a nitrate & a chlorate, such as KClO_3 , consolidated by means of molten paraffin or naphthalene

Refs: 1) Cundill (1889) in MP 6, 19 (1893)
 2) Daniel (1902), p 389 3) Giua, Trattato 6 (1959), p 394

Jute, $\text{C}_{12}\text{H}_{18}\text{O}_9$; mw 306.26, O 47.02%; fibers of East Indian, South American & Chinese plants, such as Corchorus, Olitorius, Capsularis & Abutilon Avicenna. It is used extensively in the manuf of gunny sacks, bags & twine (Ref 6). On nitration it yields:

Nitrojutes, $\text{C}_{12}\text{H}_{15}\text{O}_6(\text{NO}_3)_3$, N 9.52% to $\text{C}_{12}\text{H}_{14}\text{O}_5(\text{NO}_3)_4$, N 11.52%; expl compds prepd in 1889 by Cross & Bevan (Ref 1) by nitrating jute with mixed acid contg about equal vols of concd nitric & sulfuric acids. The authors do not state the ratio of acid to jute. Temp of nitration was 18°, time 30 mins, N content 10.5% which corresponds to a compn between the above formulas

Mühlhaeuser (Ref 2) nitrated jute previously purified by boiling in a 1% Na_2CO_3 soln followed by a water rinse. By using 1p dry jute & 15 parts of acid, 2/1 concd H_2SO_4 /concd HNO_3 , a product with 12.26% N and 132% yield was obtd. The props of Nitrojute are similar to those of nitrated lignocelluloses (See Lignin Nitrate in this Vol)

Since the cost of jute is higher than that of cotton or wood pulp, and since Nitrojutes are no better than ordinary NC, there is no advantage in manufg Nitrojutes. They were never used in expls, except for experimental purposes

Refs: 1) C.F. Cross & E.J. Bevan, JChem-Soc 55, 199 (1889) 2) O. Mühlhaeuser, ChemZtg 16, 163 (1892); JSCI 11, 546 & 937 (1892); and DinglersPolyJour 283, 88 & 137 (1892) 3) P.G. Sanford, "Nitroexplsives", Crosby Lockwood & Son, London (1896), pp 125-27 4) Daniel (1902), pp 557-58 5) Marshall 1 (1917), p 149 6) Hackh's (1944), p 463; (1972), p 367

K

K (Pulver). See under Erosion of Gun Barrels in Vol 5, p E116-L

K₁ and K₂ (of Muraour). For a proplnt whose burning rate, V , may be expressed by $V=a+bp$, where a and b are constants and p is the ambient pressure, Muraour defines a constant, K_1 , which is the total area under an *ideal* pressure-time curve, and not the *real* pressure-time curve.

The *ideal* combustion rate V_i is given by $V_i=bp$. At low ambient press, the *real* f pdt, based on V , is always less than the "ideal" f pdt which is obtained from V_i . Thus $K_1 = f$ pdt (based on V_i) is always greater than the *real* f pdt (based on V). The constant K_2 is obtained by dividing K_1 by the proplnt thickness, and is inversely proportional to the rate of diminution of proplnt thickness for a proplnt ignited on two opposite faces

Refs: 1) H. Muraour et al, MAF 22, 517 (1948) 2) P. Prache, MP 32, 350 (1950)

K-1 Explosive (Russ K-1 Splav, K-1 Fusion, Mixture K-1). Mixture consisting of TNT 70 and DNB 30%, used during WWII for filling some land mines made of cast iron. Although this mixt was less brisant than TNT, it was nevertheless too brisant for a container made of cast iron material, and sometimes broke it into fragments too small to be effective against personnel. For this reason, the brisance of K-1 was reduced by the insertion in its mass of long blocks of a less brisant expl, such as Schneiderite. Because of the toxicity of K-1, it was preferable to use K-2, described below

Refs: 1) Shilling (1946), 240 2) PATR 2145 (1955), Russ 10

K-2 Explosive (Russ K-2 Splav, K-2 Fusion, Mixture K-2). Mixture containing TNT 80 and DNN 20%, used for loading 82mm Land Mines made from cast iron. It was less toxic than K-1, described above

Refs: 1) Shilling (1946), 240-41 2) PATR 2145 (1955), Russ 10

Kadinite. A Dynamite containing NG 26, Na nitrate 56, sulfur 10, carbon 4 & ligneous

materials 4%. Daniel (Ref 1) uses the name Kadmite for the same compn

Refs: 1) Daniel (1902), 390 2) M. Guia, Trattato 6 (1) (1959), 388

Kaipinites. Expls resembling Cheddites (See Vol 2 of Encycl, p C155-L) developed in Fr based on the study of the Belg Yonckites. *Kaipinite O No 12* contains Amm perchlorate 38, Na nitrate 28 & TNT 34%; *Kaipinite O No 13* consists of Amm perchlorate 38, Na nitrate 31 & TNT 28%. They are used for demolition and mining purposes

Refs: 1) Vennin, Burlot & Lécorché (1932), 546 2) O.E. Sheffield, "Handbook of Foreign Explosives", US Army Foreign Science & Technology Center, FSTC 381-5042 (Oct 1965), 225

Kaliialmatrit No 55. See under Almatrites in Vol 1, p A140-L

Kallenites. Dynamites patented in Australia in 1899 by Callaghan & Fraser, recommended for underground work because they did not produce poisonous gases. They contained NG, absorbed by finely ground eucalyptus leaves and tree bark. Some varieties contained K nitrate and NC

See Fraser & Callaghan in Vol 5, p F186-L

Ref: Daniel (1902), 390

Kamikaze Bomb. See under Baka Bomb in Vol 2, p B4-R

Kanite. A US AN expl containing a substance akin to oxidized (blown) oil

Ref: W.H. Blumenstein, Interstate Com Commission Opinion No 1557 (1 June 1911) & CA 5, 2949 (1911)

Kanone. Ger or Swiss for Cannon

Kapsiul'. Russ for blasting cap, detonator or igniter

Ref: B.T. Fedoroff et al, PATR 2145 (1955), p Russ 28

Kapsiul' Detonator. Russ blasting cap containing the following expl compns (Ref 1)

Type	Composition (grams)					Use
	MF	Stab Mixt	Lead Styphnate	LA	Base Charge	
No 8 & No 8M	0.5	—	—	—	1.02 Tetryl or 1.00 PETN or RDX	Blasting
No 8A	—	—	0.10	0.20	same	Blasting
TAT-1 & TAT-2	—	—	0.06	0.21	0.11 Tetryl	Fuze
M-1	—	0.1	—	0.20	0.10 Tetryl	Fuze

Kapsiul' Vosplamenitel'. Igniter cap, usually referred to as *squib*. If followed by "udarnykh sostavov", it refers to percussion igniters. The formulation used in rifle ("vintovochnyi") percussion caps is MF 16.7, K chlorate 55.5 & Sb trisulfide 27.8%; for pistol ("revol'vernyi") percussion caps, MF 25.0, K chlorate 37.5 & Sb trisulfide 37.5%; and for mine throwers ("minomëtnyi"), MF 35.0, K chlorate 40.0 & Sb trisulfide 25.0% (Ref 2)

Igniter caps containing non-corrosive ("ne-korrodiruyou-shchikh") percussion compns: MF 67.8, Ba nitrate 29.6 & Sb trisulfide 2.6% (for rifles); Czeck "Oksid": Lead Styphnate 45.0, Tetracene 5.0, Ba nitrate 30.0 & Sb trisulfide 20.0% (for pistols) (Ref 3)

Kapsiul' Vosplamenitel', Trubochnye. Tubular igniter caps containing the following percussion mixts: a) KTM cap — MF 25.0, K chlorate 37.5 & Sb trisulfide 37.5%; and b) RGM cap — MF 50.0, K chlorate 25.0 & Sb trisulfide 25.0% (Ref 4)

Refs: 1) Gorst (1957), 126 2) Ibid, 115 & 120 3) Ibid, 116 4) Ibid, 120

Kardox Cartridge. See under Cardox in Vol 2, p C67-R

Karitto. See under Carlit in Vol 2, p C68-R and under Japanese Explosives in this Vol

Karl Fischer Method for Determination of Moisture. See under Dynamites in Vol 5, p D1622-L and under Ethanol in Vol 6, p E158-R

Karman, Theodor von (1881–1963). Hungarian scientist who worked in Germany & the US on aeronautical problems, on rockets, and on combustion phenomena

Ref: Anon, *Explosivst* 1963, 134

KA-Salz. One of several Ger names for RDX. See under Cyclotrimethylenetrinitramine, Cyclonite or RDX in Vol 3, pp C611-L to C626-L

Kast Brisance Meter. See Brisance in Vol 1, p IX; Compression Tests in Vol 1, p X; also see under Brisance or Shattering Effect in Vol 2, pp B265-L to B297-L, and Brisance Test Methods in Vol 2, pp B299-L to B300-R

Kast, H (1869–1927). A Ger scientist who specialized in expls, and was for many years associated with the Chemisch-Technische Reichsaustalt. He designed an apparatus for the detn of brisance of expls (brisance meter), and developed a formula for theoretical calculations of brisance. Kast also developed an impact machine (Kast Stauchapparat) that was

for many years the "standard" impact test for expls. He was the author of several books and articles on expls

Ref: F. Lenze, *SS* 22, 305 (1927) & *CA* 22, 1238 (1927)

Katiusha (Katyusha or Kostikov's Gun). Russ 132mm rocket launcher M-13. It consisted of a truck-mounted system for firing 16 rockets from eight rails. The M-13 weighed 7.1 tons and fired 94-lb rockets to a max range of 9846 yards

Refs: 1) Anon, *FieldArtillJ* (Nov 1943), 816
2) G. Underhill, *InfantryJ* (May 1945), 44-49
3) J. Quick, *Dictionary of Weapons and Military Terms*, McGraw-Hill (1973), 256

KDNBF. Acronym for the K salt of Dinitrobenzofuroxan. See Vol 2, p B68-R

Keeping Test. One of the tests used in England to determine the exudation of Dynamites; other methods include press and centrifugal tests. In this procedure, a previously weighed cartridge of Dynamite is stored in a vertical position for 6 days at 40°, and then reweighed. If leakage exceeds 5%, the expl is considered unsatisfactory

With straight Dynamites, this test correlates well with the pressure test; for other Dynamites, agreement is not as good

Ref: Marshall 2 (1917), 421

Keil Explosive. A mixt of nitrodextroglucose (prepd from starch) with K nitrate or chlorate & vegetable fibers

Ref: Daniel (1902), 391

Kekulé Oil. A liq expl ($d=1.47g/cc$) prepd in 1869 by passing ethylene gas into mixed nitric-sulfuric acid. The oil consisted of a mixt (about 50/50) of Nitroglycol, $CH_2(ONO_2)-CH_2(ONO_2)$, and beta-Nitroethyl Nitrate, $CH_2(ONO_2)CH_2NO_2$

Refs: 1) Naoúm (1928), 220-21 2) Davis (1943), 228

Kelbar Powder Company Explosive. The Kelbar Powder Co of Avondale, Pa developed an expl contg Amm Nitrate 93.37, resin 6.57 & moisture 0.05%. It had satisfactory brisance and stability was comparable to TNT & 80/20 Amatol, but was sensitive to bullet impact and was rendered very insensitive by compression. Its high mp (about 160°) made loading of shells or bombs by casting or extrusion impracticable, therefore the expl was thought to offer no particular promise

Ref: J.D. Hopper, "Study Ammonium Nitrate Explosive Received from Kelbar Powder Company", *PATR* 1009 (Oct 1939)

Kelbetz Explosives. Expls patented in England in 1896 by an Austrian, Kelbetz. They consisted of AN mixed with oxalates of aromatic amines, such as aniline and toluidine, and sometimes also contained small quantities of charcoal. Other Kelbetz expls contained about 95% AN, fatty acids such as stearic, palmitic, oleic, etc (with or without their metallic soaps, such as Ca), and small quantities of charcoal

Ref: Daniel (1902), 391

Kellow and Short. Patented in 1862 in England an expl mixt consisting of K nitrate, Na nitrate, K chlorate, sulfur, barkmeal or sawdust

Ref: Daniel (1902), 391

Kelly, Bell and Kirk Explosive. Australian Dynamite patented in 1899, containing NG, K nitrate, cork and calcined eucalyptus leaves

Ref: Daniel (1902), 391

Kent, Robert H (1886-1956). American ballisticians at Aberdeen Proving Ground, Maryland from 1922. His achievements are described in a series of articles in *Ordnance* 40, 769-81 (1956)

Kent Powder. A Brit coal mine expl no longer on the "permitted" list. It contained NG 24,

K nitrate 32.5, wood meal 33.5 & Amm oxalate 10%. It had a charge limit of 32 oz, and power by ballistic pendulum of 2.01"

Ref: Marshall, Dict (1920), 53

Kentite. A Brit "permitted" coal mine expl of the Favier type. It contained AN 34, K nitrate 34, TNT 15 & Amm chloride 17%.

It had a charge limit of 18 oz; power by ballistic pendulum 2.64", compared with 3.27" for Brit standard 60% Gelnite (See Vol 5 of Encycl, pp G57-Rff)

Refs: 1) Barnett (1919), 132 2) Marshall, Dict (1920), 53 3) Marshall 3 (1932), 119

Kerosene (Kerosine, Coal Oil, Astral Oil). A mixt of petroleum hydrocarbons, chiefly of the methane series having from 10 to 16 carbon atoms per molecule. It constitutes the fifth fraction in the distn of petroleum, after the petroleum ethers and before the oils. Pale yel or w-white, mobile liq; characteristic, not altogether disagreeable odor; bp 175–325°, flash pt 150–185°F, d about 0.80g/cc. Insol in w, misc with other petroleum solvents. Besides uses as a fuel, illuminant and cleansing agent, it is used as a rocket and jet engine fuel (Refs 1, 3 & 4)

An underground storage tank, partially filled with kerosene, exploded, killing 29 people. The expln occurred after CO₂ was pumped into the tank to test a fire-extinguishing installation (Ref 2)

Refs: 1) Davis (1943), 66 2) K. Nabert & G. Schön, Erdöl u Kohle 8, 809 (1955) & CA 50, 8207 (1956) 3) Merck (1968), 599-R 4) CondChemDict (1971), 496-R

Kerosene Nitrate. Fiala claims the nitration of kerosene by adding 3–5cc of concd nitric acid per liter of kerosene with vigorous stirring, and allowing it to stand for several days

Ref: F. Fiala, USP 2511433 (1950) & CA 44, 8103 (1950)

Kerr Cell. See under Cameras, High-Speed Photographic in Vol 2, p C15-L

Kessen Explosives (Kessensprengstoffe in Ger). Several expl mixts were proposed by W. Kessen of WASA-G (Wastfälisch-Anhaltische Sprengstoff Aktiengesellschaft). One of such compns, patented in 1938 (Ref 1), consisted of BlkPdr used for blasting mixed with NG and/or nitroglycol and a large amt of Na bicarbonate. It was intended for use in gaseous coal mines

Another patent issued to Kessen (Ref 2) dealt with the manuf of moist AN expls contg large amounts of carbonaceous materials

Refs: 1) W. Kessen & WASA-G, BritP 493984 (1938) & CA 33, 2719 (1939) 2) Ibid, GerP 679511 (1939) & CA 33, 9647 (1939) 3) PATR 2510 (1958), Ger 101-L

Ketocyclopentane. See Cyclopentanone in Vol 3, pp C603-R to C603-L

Ketohexamethylene. See Cyclohexanone in Vol 3, p C597-L

Ketone Peroxides. Bjorklund and Hatcher (Ref 1) prepd several expl compds by treating ketones with hydrogen peroxide–nitric acid mixts. The probable compns of these compounds are as follows:

- 1) (C₃H₆O₂)₃; white solid; mp 95–97°; was obtained by adding acetone to a mixt of H₂O₂ and 70 HNO₃; it exploded violently on impact, sudden heating or treatment with concd H₂SO₄
- 2) (C₃H₆O₂)₂; white solid; mp 131–32°; was obtained by adding a mixt of H₂O₂–70% HNO₃ to acetone; it is a violent explosive
- 3) (C₅H₈O₂)₃; white solid; mp (decomp 166–67° and explodes violently at higher temps); was prepd from cyclopentanone, H₂O₂ and HNO₃
- 4) (C₆H₁₀O₂)₂; white solid; mp 126–27°; was prepd from cyclohexanone, H₂O₂ and HNO₃; it is a violent explosive
- 5) Explosive oils of unknown compn obtained by treating methylethylketone, ethylethylketone and 3-methylcyclohexanone with a H₂O₂–HNO₃ mixt

Ref: G.H. Bjorklund & W.H. Hatcher, Trans-RoySocCanad 44, Sect III, 25 (1950) & CA 45, 7952 (1951)

2-Ketotrimethyleneimine. See 2-Azetidinone in Vol 1, p A519-L

Ketoximes and Derivatives. The Dow Corning Corp reported an expl hazard inherent to ketoximes and many of their derivatives. In manufg ketoximosilanes,

$\text{RSi}(\text{O}-\text{N}=\text{C} \begin{matrix} \text{Et} \\ \text{Me} \end{matrix})_3$, two potentially devastating explosions were experienced. An analysis of the incidents strongly suggests that acidic conditions were inadvertently generated which markedly lowered the threshold temps required for expl decompn of these materials. It is suspected that conditions were unintentionally produced under which the highly exothermic Beckman rearrangement preceded, and that the resulting high temps resulted in the explosively rapid formation of huge volumes of gaseous degradation products

Subsequent expts led to the following findings: 1) Methyl ethyl ketoxime can be distilled at atmos press (152°) only if highly purified; 2) The presence of impurities, especially acidic impurities, drastically lowers the temp at which degradation occurs; the hydrochloride salt of methyl ethyl ketoxime undergoes violent degradation when heated to $50-70^\circ$; 3) Although the derived ketoximosilanes can be distd without difficulty at reduced press, here again the presence of acidic impurities drastically lowers their thermal stability. FeCl_3 at 10ppm did not trigger the degradation even at 250° , but 500ppm yielded an expln at 150° , and 2% lowers the onset of violent degradation to 50° . As with the ketoxime itself, the presence of HCl salts can cause expl degradation at relatively low temps

Ref: L.J. Tyler, "Ketoxime Dangers", C&EN 52 (35), 2 (2 Sept 1974)

Keystonite. See under Alkalies, Action on Aromatic Nitrocompounds in Vol 1, p A126-R

KH-Charge (KH-Ladung in Ger). The designation for a compressed charge consisting of 4-8 pellets of TNT, wrapped in paper and glued on the inside with an acid-free glue such as dextrin.

The wrapped charges are dried at $60-70^\circ$ and then dipped in paraffin. They were used as bursting charges in mines

Refs: 1) Anon, PB Rept No 925 (1945), 48 2) PATR 2510 (1958), Ger 101-L

Kickless or Recoilless Weapons. Weapons where the recoil effect is reduced and counteracted by vents in the breech which deflect up to 80% of the expansion gases to the rear. Recoilless weapons can therefore fire artillery-sized ammo without generating artillery-sized recoil, or any recoil at all. Thus, the heavy mountings and recoil-absorbing devices needed with artillery weapons are not required; with internal stress and muzzle energies low, the barrel can be much thinner and lighter than that of a full-recoil gun firing the same weight of shell. Naturally, the effective range is also much smaller than with full-recoil weapons. For calibers of about 100mm, a recoilless rifle (RR) will have a max range of 1000-2000 yards, as opposed to a full-recoil gun range of about 25000 yards. But the ratio of weapon weights is also of the order of 1 to 20 even counting the wheeled mounts used with some RR's, and cost ratios are also in this range. Recoilless weapons are used whenever the range is secondary to the size of shell delivered, and where high velocities are not required. RR's are primarily intended for anti-tank use where their "hollow charge" (HEAT) shells penetrate armor without needing the kinetic energy required by conventional solid shot fired from full-recoil artillery

The US 106mm RR and two earlier US models which can be fired from the shoulder, the 75 and 57mm, are widely used, as is the Russ B-11 107mm RR and the older B-10 82mm RR. Another widely used type is the one-man 84mm *Carl Gustav*, manufd in Sweden and used by, among others, the Brit army. The largest recoilless weapon, the Brit *Wombat* 120mm, is not widely used. These are all properly called recoilless rifles since their barrels are rifled as in the case of conventional artillery. Some light recoilless weapons have smooth barrels and project a HEAT charge attached to a reduced caliber "stick" which fits into the barrel. The West Ger *Panzerfaust* and the Russ

RPG both consist of a small caliber tube (about 40mm) within which the charge and "stick" are set. When the weapon is fired, the "stick" and the much larger HEAT charge affixed to its end are projected out. These are short-range, one-man weapons fired from the shoulder (Ref 1)

A novel approach to reducing recoil in conventional artillery is the US XM-204 Soft Recoil Gun, still in an early stage of development. The barrel and recoiling parts are held in a firing position against a spring; when released they move forward. At their maximum forward velocity, the charge is fired. Much of the recoil energy is expended in checking the forward momentum of the barrel, the remainder is absorbed conventionally and "recocks" the spring used for the first part of the sequence. Recoil forces transmitted to the carriage are reported to have been halved (Ref 2)

Note: See also under Cannon in Vol 2, p C28-R

Refs: 1) E. Luttwak, "A Dictionary of Modern War", Harper & Row, NY (1971), 162-R 2) Anon, "RUSI and Brassey's Defence Yearbook 1974", Praeger, NY (1974), 325

Kier or Keir. A large vat in which cotton, textile goods etc are boiled, bleached, etc

Kiering. Digestion of raw cotton, or other materials, in kettles called Kiers. For instance, raw cotton may be purified by digesting it in a kier with a solution of caustic soda

Ref: Marshall 3 (1932), p 29

Kiernan and Bowen Explosive. An expl mixt developed by Kiernan & Bowen of New Orleans, La, contg Na chlorate 75, turpentine 10, bone-meal 10 & dried blood 5%. It was concluded that this expl had no value from a military standpoint because of its low brisance, high degree of sensitivity to impact, and the ease with which it lost turpentine, which resulted in decreased sensitivity to initiating agents
Ref: A.J. Phillips, "Study of Sodium Chlorate Explosive Developed by Kiernan and Bowen", PATR 1277 (April 1943)

Kieselguhr or Guhr (Diatomite, Tripoli Powder). Soft bulky solid material, 88% silica, composed of skeletons of small prehistoric aquatic plants related to algae (diatoms). It has the property of absorbing up to three times its weight of NG and other liquids. It was formerly used extensively in the manuf of Guhr Dynamites, invented by Nobel in 1866 (See under Dynamite in Vol 5, pp D1595-L to D1596-R). Present-day straight Dynamites have various proportions of active constituents substituted for kieselguhr with resulting higher performance (Ref 3)

Kieselguhr has also been used as a coating agent for porous *prilled* AN in Nitro-carbonitrate (NCN) blasting agents, where it aids in the absorption of fuel oil (Ref 3)

Refs: 1) Hackh's (1969), 372-L 2) Cond-ChemDict (1971), 274-R (under diatomaceous earth) 3) C.E. Gregory, "Explosives for North American Engineers", TransTech Publications, Cleveland (1973), 42 & 55

Kinenite. AN expl containing DNB, somewhat similar in compn to Bellite (Vol 2, p B32-R), Roburite, Sekurite & Tonite
Ref: Colver (1918), 141

KINETICS IN EXPLOSION PHENOMENA

Introduction. In a very broad sense, kinetics (often called *chemical kinetics*) may be defined as the study of the rate of change of chemical reactions under non-equilibrium conditions. This incomplete definition will be augmented below, but first we must consider why kinetics are such an important facet in the practical and theoretical understanding of explosion phenomena

There is general agreement that the energy sources for detonations, deflagrations, thermal explosions and various transition phenomena are exothermic chemical reactions. Thus, it is immediately clear that the rate of energy supply, ie, the rate of the chemical reactions, will have a most important bearing on the initiation, growth and propagation of the above processes. Obviously, the influence of kinetics on explosion phenomena is an immensely broad subject. Consequently, we must arbitrarily limit

ourselves to a description of only a relatively few of its most important aspects, namely, *detonations* and *thermal explosions*, to the extent that the latter are required for a description of detonation effects. The kinetics of individual explosives, if known, will be described under the individual explosives, and, as already stated, we will be primarily concerned with the rate of energy supply, ie, the rate of the thermal decomposition of explosives and the resulting exothermic reactions. The kinetics involved in the synthesis of explosive compounds, eg, *nitration kinetics*, will be described elsewhere in this Encycl

A Cursory Review of Chemical Kinetics. In what follows we will employ certain concepts and terms widely used in the extensive literature on chemical kinetics. These concepts and terms will now be reviewed briefly. For details, the reader is directed to the general references listed at the end of this section

For a generalized chemical reaction whose stoichiometric (overall) equation is

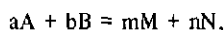

the reaction rate R is defined by

$$R = -\frac{1}{a} \left(\frac{dA}{dt} \right) = -\frac{1}{b} \left(\frac{dB}{dt} \right) = \frac{1}{m} \left(\frac{dM}{dt} \right) = \frac{1}{n} \left(\frac{dN}{dt} \right) \quad (1)$$

where a , b , etc are the number of moles of chemical species A , B , etc, and (dA/dt) , (dB/dt) etc, are the rate of change of species A , B , etc. If experiments show that the reaction rate is independent of reactant A , the reaction is called *zero-order in A*; if the rate depends on the instantaneous value of A , the reaction is termed *first-order in A*; if the rate depends on the instantaneous value of A^2 , the reaction is called *second-order in A*, and so on. In most explosion phenomena we will deal only with zero-order and first-order reactions. The *rate equations* for zero-order and first-order reactions are, respectively

$$-\frac{dA}{dt} = k_0 \quad \text{or} \quad A_0 - A = k_0 t = 1 - f \quad (2)$$

and

$$-\frac{dA}{dt} = k_1 A \quad \text{or} \quad \ln \left[\frac{A_0}{(A_0 - A)} \right] = k_1 t = \ln \left(\frac{1}{1-f} \right) \quad (3)$$

where k_0 and k_1 are the zero-order and first-order *rate constants*, respectively; A_0 is concentration of species A at zero time; A is the

concentration of species A at time t ; f is A/A_0 , the fraction of A_0 reacted in time t . The rate constants k_0 and k_1 have the units of moles/liter-sec and sec^{-1} , respectively, if the concentrations are expressed in moles/liter. Obviously, the above definitions could have been made in terms of B or M or N , except that in accordance with Eq 1, the minus signs of the differential equations for M and N (Eqs 2 & 3) must be replaced by plus signs. An excellent review of higher order reactions, opposing reactions, consecutive reactions, etc, is given in Chaps II & III of Ref.10 and in Ref 11

Rate constants are "constant" only at a fixed temp and vary strongly as the temp of the system changes. The following *empirical* dependence of the rate constant k on the absolute temp T is known as the Arrhenius equation

$$\frac{d \ln k}{dt} = \frac{E}{RT^2} \quad \text{or} \quad k = Z e^{-E/RT} \quad (4)$$

where the Arrhenius parameters E and Z are called *activation energy* and *frequency factor* or *pre-exponential factor*, respectively. The usual dimensions of E are cal/mole. The dimensions of Z are the same as those of k ; thus for a zero-order reaction Z is in moles/liter-sec, and for a first-order reaction Z is in sec^{-1} . The term E/RT is dimensionless. Based on kinetic theory, Z is interpreted (Refs 1, 2, 6, 10 & 11) as the number of collisions per unit volume per second of molecules $A+A$ or $A+B$, and the term $e^{-E/RT}$ is a measure of the fraction of colliding molecules that result in reaction. Thus, if $E=0$, then $e^{-E/RT}=1$, and all colliding molecules react; conversely, if $E/RT \gg 1$, almost none of the colliding molecules react

An alternate approach, the so-called *transition state* or *activated complex* theory, is based on quantum mechanics and thermodynamics. It postulates that the necessary condition for reaction is the crossing of a potential energy barrier. The initial configuration (reactants) passes over by continuous changes of coordinates to the final configuration (products), and there is always an intermediate configuration (the transition state or activated complex) which is critical for the process. Once this critical configuration is attained there is a high

probability that the reaction will go to completion (Refs 5, 6, 10 & 11). In terms of this theory $E = \Delta H^* + RT$, where ΔH^* is the difference in enthalpies between the activated complex and the initial state, and

$$Z = \frac{k_B T}{h} e^{\Delta S^*/R} \quad \text{where } k_B$$

and h are the Boltzmann and Planck constants, respectively, and ΔS^* is the entropy change in passing from the initial state to the activated complex

Both the collision and activated complex theories predict a mild dependence of Z on T , and the latter also predicts a mild dependence of E on T . In practice, over the limited temp ranges of the usual exptl conditions, these mild dependencies are rarely observed. Both theories also predict that "normal" values of Z should be 10^{13} to 10^{14} sec^{-1} for unimolecular processes. This agrees with many exptl observations. In many cases, however, because of steric effects, Z can be much smaller than "normal". Benson (Ref 12) presents evidence that Z for certain unimolecular gas reactions producing two free radicals, or for reactions involving the opening of a "small" carbon ring, is larger than "normal" and is of the order 10^{16} sec^{-1}

All of the above discussion is strictly applicable only to homogeneous gas phase reactions. Usually the above considerations do apply reasonably well to non-polar liquids and non-polar solutions, although "normal" Z values may be an order of magnitude less than for gas reactions. Reactions in solids are often much more complex, since they are usually heterogeneous, involve catalytic effects, reactions at preferential sites (dislocations, etc), and nucleation phenomena. These complicated processes are quite beyond the scope of the present article. For some description of these phenomena, and further references, the reader should consult Refs 9, 10 & 11

Another important aspect that we have so far ignored is that reactions almost never actually proceed as represented by a stoichiometric equation (eg, Eq 1). Usually a stoichiometric equation is the algebraic sum of a number of steps called *elementary* reactions. Frequently one of these elementary reactions is much slower than the others, and thus con-

trols the overall reaction rate. For obvious reasons such a reaction is called *rate-controlling*, and the overall rate constant is essentially that of this rate-controlling step

For complex reactions, some of whose elementary steps are of comparable rates, but others are slower, the so-called *steady state hypothesis* (Refs 4, 6, 10 & 11) can occasionally lead to a simple theoretical description (mechanism) of the complex reaction. A famous example of this is the thermal decompn of N_2O_5 , where the observed kinetics for this reaction are accurately first-order, even though the reaction is complex (Ref 10)

For overall Arrhenius parameters (based on measurements of the overall rate constant as a function of temp), there are no "normal" values if the reaction involves several elementary steps of comparable rates. Indiscriminate use of such parameters in assessing detonation phenomena (eg, hot spots) can lead to gross errors. The reader is reminded that much of the existing kinetic data for explosives are based on the measurement of the overall pressure changes in the system under study. Unless the detailed reaction sequence, usually called the *reaction mechanism*, is known, *Arrhenius parameters based on pressure change measurement can be most unreliable*

Refs for this section: 1) R.C. Tolman, "Statistical Mechanics", NYChemCatalogCo, NY (1928) 2) L.S. Kassel, "Kinetics of Homogeneous Gas Reactions", ReinholdPublCorp, NY (1932) 3) N. Semenov, "Chemical Kinetics and Chain Reactions", ClarendonPress, Oxford (1935) 4) G.K. Rollefson & M. Burton, "Photochemistry and the Mechanism of Chemical Reactions", Prentice-Hall Inc, Englewood Cliffs, NJ (1939) 5) S. Glasstone, K.J. Laidler & H. Eyring, "The Theory of Rate Processes", McGraw-Hill, NY (1941) 6) W.A. Noyes, Jr & P.A. Leighton, "The Photochemistry of Gases", ReinholdPublCorp, NY (1941) 7) E.W.R. Steacie, "Atomic and Free Radical Reactions", 2nd Edit, ReinholdPublCorp, NY (1954) 8) D.A. Frank-Kamenetskii, "Diffusion and Heat Exchange in Chemical Reactions", Princeton Univ Press, Princeton, NJ (1955) 9) F.P. Bowden & A.D. Yoffe, "Fast Reactions in Solids", Academic Press, London (1958) 10) S.W.

Benson, "The Foundations of Chemical Kinetics", McGraw Hill, NY (1960) 11) H. Eyring & E.M. Eyring, "Modern Chemical Kinetics", ReinholdPublCorp, NY (1963) 12) S.W. Benson, "Thermochemical Kinetics", J. Wiley & Sons, NY (1968)

Application of Kinetics to Explosion Phenomena.

Brief mention was made earlier of the various explosion phenomena that are strongly dependent on the kinetics of the exothermic chemical processes involved in explosions and detonations. This matter will now be considered in more detail as follows:

- 1) Steady Detonation, 2) Initiation Processes,
- 3) Stability and Storage, and 4) The "Ideal" Explosive

In what follows, the experimental Arrhenius parameters E and Z may be for the overall exothermic process and may not always refer to the E and Z of a simple elementary reaction in that process

Steady Detonation. The thermo-hydrodynamic theory of detonation is very successful in describing ideal detonation parameters (CJ states) without any reference to chemical kinetics. This is so because reaction rates at CJ conditions are extremely fast — at least for military explosives. Based primarily on the dependence of detonation velocity on explosive charge diameter, Jones, Eyring and others (Refs 2, 3, 10 & 11) have estimated that reaction times for ideal detonations of military explosives are the order of 0.1 to 1 μ sec. Thus for ideal detonation conditions, f , the fraction of explosive reacted, must approach unity in times that are appreciably less than 0.1 to 1 μ sec. In Table I we show that this is indeed the case. The calculations of f were made under the assumption of isothermal first-order decomposition at T_{CJ} (conservatively estimated in the tabulation), and the kinetic parameters of Table III of a following section

Table I
Isothermal Decomposition of Explosives
at CJ Conditions

Explosive	Arrhenius Parameters*	τ (nanosec)	T_{CJ} ($^{\circ}$ K)	Fraction Reacted (f)
TNT	Zinn & Rogers	10	2250	1
TNT	Zinn & Rogers	1	2250	0.70
NMe	Makovsky & Gruenwald	1	3000	1
NMe	Makovsky & Gruenwald	0.1	3000	0.74
PETN	Robertson	0.1	2550	1
PETN	Roth	1	2550	1
PETN	Roth	0.1	2550	0.99

*See Table III

Initiation Processes. For an adiabatic thermal explosion, the delay τ is given by (See Vol 4, p D620 and this Vol, under Hot Spots, p H170ff)

$$\tau = \frac{CRT^2}{QZE} \exp(E/RT) \quad (5)$$

where Q is the heat of explosion and c is the specific heat. The controlling variable in this equation is the activation energy E obtained from *kinetic studies*. This is shown in Table II

Table II
Influence of Kinetics on Adiabatic
Explosion Times of PETN

Arrhenius Parameters*	$T(^{\circ}$ K)	τ (sec)
Robertson	2550	8.8×10^{-18}
Andrew & Kaydimov	2550	4.7×10^{-14}
Roth	2550	1.7×10^{-12}
Robertson	1000	2.7×10^{-12}
Andrew & Kaydimov	1000	8.6×10^{-10}
Roth	1000	5×10^{-9}
Robertson	750	4×10^{-9}
Andrew & Kaydimov	750	3.3×10^{-7}
Roth	750	5.1×10^{-7}
Robertson	600	7.8×10^{-6}
Andrew & Kaydimov	600	1.5×10^{-4}
Roth	600	7.5×10^{-5}
Robertson	500	1.3×10^{-2}
Andrew & Kaydimov	500	1.1×10^{-1}
Roth	500	1.0×10^{-2}

*See Table III

Note that variation in Arrhenius parameters strongly influences τ at high temperatures, but regardless of the source of the kinetic data, the conclusion that chemical reaction is exceedingly fast at CJ temperatures is still valid. At lower temperatures (the region where initiation processes presumably occur) considerable compensating effects are evident and the computed explosion times are much less dependent on data source than they are at high temperatures.

Campbell et al (Ref 7) have successfully used Eq 5 to interpret their observations on the shock initiation of homogeneous explosives such as NM, liq TNT & single crystal PETN

Heterogeneous initiation phenomena, generally interpreted in terms of *hot-spot* mechanisms, are also strongly influenced by the kinetics of exothermic decompn of the explosive being initiated. The general relations between hot spot parameters and decompn kinetics parameters are given in Eqs 1 thru 5 of the article on Hot Spots in this Vol, pp H170ff. Of special interest is a recent interpretation of the initiation of explosives by impact presented by Afanasev & Bobolev (Ref 12), described under *Impact, Initiation of Explosion by* in this Vol, pp 135ff. In Ref 12, the relation between the variables controlling impact initiation and the kinetic parameters of the explosive impacted are given by their Eqs 11 thru 14. A rather different treatment of impact initiation, based on adiabatic compression of small occluded gas bubbles in explosives, and the dependence of these processes on chemical kinetics are presented by Bowden and Yoffe (Refs 5 & 6)

The large uncertainty in the quantitative interpretation of heterogeneous initiation phenomena results not only from the uncertainty of the kinetic parameters used (See section on Kinetic Data), but also from the large uncertainty of the temps of the initiation sites (hot spots)

Storage and Stability. It is obvious that practical explosives must possess long storage life. Kinetic data are most useful in evaluating the storage characteristics of an explosive, but they must be the right kind of data. Most explosives are solids under normal storage conditions. Thus, kinetic data obtained

for a particular explosive in its vapor or liquid state and then used to estimate its storage life, could give very misleading results. Furthermore, most explosives decompose autocatalytically, ie, they produce decomposition products that accelerate further decomposition. Also, impurities not removed during manufacture can greatly shorten storage life. All of these facts must be taken into account

As an example, let us consider the storage characteristics of liquid NG at 21° (294°K). Unfortunately, the Arrhenius parameters for NG given in the literature (Table III) vary widely. An average of the Serbinov-Roth parameters (Tables III & IV) gives an adiabatic explosion time of 32 years at 21°, while the Robertson parameters (Table III) give a time of 2500 years! Since conditions will not be adiabatic over long periods of time, the calculations show that pure NG has good storage life — certainly longer than 32 years. However, Gorbunov & Svetlov (Ref 8) have shown that induction periods at 40°, to the onset of rapid gas production, are approximately in the ratio 7:3.5:1 for pure NG, NG with 0.16% w, and NG with 0.17% nitric acid. Thus, the storage life of NG containing minor amounts of nitric acid can be expected to be at least seven-fold less than that of pure NG. Nitric acid in NG can be an impurity not totally removed during manuf, and it can also be a decompn product ($3\text{NO}_2 + \text{H}_2\text{O} = 2\text{HNO}_3 + \text{NO}$)

The "Ideal" Explosive. From a kinetics point of view the "ideal" explosive is readily identifiable, but to find such an explosive is quite another matter. To possess good storage life and be impervious to moderate energy stimuli, the ideal explosive should have a large E, small Z, be readily purifiable, non-hygroscopic, and produce no decompn products that accelerate further decompn. It will explode only upon being subjected to large, externally applied, stimuli, such as the nearby detonation of another explosive. At present, theory offers little guidance as to what type of compounds have a large E for decompn, yet produce appreciable heat once they start to decomp (large Q). For a low value of Z, the activated complex theory indicates that ΔS^\ddagger (See Cursory Review of Chemical Kinetics section) should be negative. In terms of molecular structure,

this suggests that the activated complex has a very rigid molecular structure, while the undecomposed explosive has a very "floppy" molecular structure

Kinetic Data. In a previous section we made

extensive use of the Arrhenius parameters E and Z, and to a lesser extent of Q, the net heat of decomposition reactions. A compilation of this data is given in Table III. Unfortunately, many of these data are wildly discordant, eg, for PETN, E and logZ range from

Table III
Kinetic & Thermochemical Parameters for the Decomposition of Molten and Liquid Explosives

Explosive	Temp Range (°C)	Q (cal/g)	E(kcal/mole)	log Z (sec ⁻¹)	Experimental Method	Refs
Amm Nitrate	217–267	—	38.3	12.3	Weight loss	Cook & Abegg (7)
Amm Nitrate	243–361	—	40.5	13.8	Pressure	Robertson (2)
Diaminotrinitrobenzene (DATB)	?	—	46.3	15.1	DSC (a)	Rogers (18)
DINA	150–170	680–720	45.0	18.6	Weight loss; Pressure & Heat Evoln	Dubovitsky et al (10)
DINA	130–175	—	35.5	13.4	Adiabatic furnace	Gross & Amster (14)
EDNA	184–254	—	30.5	12.8	Pressure	Robertson (2)
EDNA	144–167	—	30.8	11.1	Weight loss	Cook & Abegg (7)
EGDN	95–105	—	39.0	15.9	Pressure	Phillips (1)
EGDN (vap)	140–170	—	35.7	14.3	Pressure	Andreev & Belyaev (9)
HMX	270–295	—	52.7	19.7	Pressure	Robertson (5)
HMX	?	560 (Ref 17)	57.3	18.8	DSC (a)	Rogers (17)
Hydrazine Nitrate	189–200	—	38.1	12.2	Weight loss	Cook & Abegg (7)
Hexanitrostilbene (HNS)	?	—	30.3	9.2	DSC (a)	Rogers (18)
NG	75–105	—	40.3	17.1	Pressure	Phillips (1)
NG	115–282	—	~35	~14	Thermal explosion	Serbinov (8)
NG (vap)	150–160	—	36	15.5	Pressure	Andreev & Belyaev (9)
PETN	160–225	—	47.0	19.8	Pressure	Robertson (2)
PETN	145–171	—	39.0	15.6	Pressure	Andreev & Kaydimov (13)
PETN	177–222	—	46.5	19.4	DSC (a)	Rogers (18)
PETN	149–201	—	31.8	13.4	Chemical analysis	Roth (6)
RDX	213–299	—	47.5	18.5	Pressure	Robertson (4)
RDX	?	—	43.1	16.4	DSC (a)	Rogers (18)
RDX	?	615	45.2	—	DSC (a)	Hall (16)
Tetryl	211–260	—	38.4	15.4	Pressure	Rideal & Robertson (3)
Tetryl	140–165	—	40.0	16.0	Pressure	Dubovitsky et al (12)
Tetryl	145–155	340	36.0	15.6	Heat Evoln	Dubovitsky et al (11)
Tetryl	?	330	—	—	DSC (a)	Hall (16)
Tetryl	132–164	—	34.9	12.9	Weight loss	Cook & Abegg (7)
TNT	257–310	—	34.4	11.4	Pressure	Robertson (4)
TNT	237–277	—	43.4	12.2	Weight loss	Cook & Abegg (7)
TNT	288 (b)	—	41.1	13.2	Thermal explosion	Zinn & Rogers (15)
TNT	220–260	300 (c)	37.0	11.2	Adiabatic furnace	Gross & Amster (14)

a) Differential Scanning Calorimeter

b) Min temp at which explosions were observed in 1-mm thick samples

c) Assumed

a high of 47.0kcal/mole and $10^{19.8}\text{sec}^{-1}$ to a low of 31.8kcal/mole and $10^{13.4}\text{sec}^{-1}$, respectively. Moreover, the temp ranges over which the kinetic parameters were measured are relatively low. Thus, there is no assurance that the parameters hold at considerably higher temps, eg, detonation temps

Some insight into what are the "best" parameters, and how valid they are at higher temps, may be gained by examining the results of the so-called *Wenograd test*. In this test liq or molten expl is loaded into a hypodermic needle which is then heated rapidly to a controlled temp by condenser discharge, and the explosion time of the test explosive at that temp is measured. Roth (Ref 9) obtained "Wenograd" kinetic parameters for NG, EGDN, TNT and Petrin. He analyzed the results in terms of Eq (5) and the following Eq based on Frank-Kamenetskii (Ref 1) and Chambré (Ref 4)

$$\frac{E}{T_{\min}} = 4.57 \log \left[\frac{\rho QZE}{\delta \lambda R} \frac{r^2}{T_{\min}^2} \right] \quad (6)$$

where: δ is a geometric factor =2 for cylinders
 λ is the heat conductivity of the expl
 r is the radius of the expl cylinder
 T_{\min} is the lowest temp at which explosions are recorded

The results in Table IV show agreement with the lower values of E and Z of Table III, except for TNT, for which "Wenograd" data are not reliable

Written by J. ROTH

Refs: 1) L. Phillips, Nature **160**, 753 (1947)
 2) A.J.B. Robertson, JSocChemInd(London) **61**, 221 (1948) 3) E.K. Rideal & A.J.B. Robertson, ProcRoySoc **A195**, 135 (1948)
 4) A.J.B. Robertson, TransFaradSoc **44**, 977 (1948) 5) Ibid, **45**, 85 (1949) 6) J. Roth, Addendum to Bulletin Sixth Army-Navy Solid Propellant Group Meeting (1950), p 41
 7) M.A. Cook & M.T. Abegg, IEC **48**, 1090 (1956) 8) A.I. Serbinov, ZhFizKh **33**, 2641 (1959) 9) K.K. Andreev & A.F. Belyaev, "Theory of Explosive Substances", FTD-MT-64-242 (1966), p 149 (Russ original published in 1960) 10) F.I. Dubovitsky, TransIzvAkadNauk(Chem) No 6, 1126 (1960)
 11) Ibid, 1763 (1960) 12) F.I. Dubovitsky et al, Russ JPhysChem **35** (3), 255 (1961)
 13) K.K. Andreev & B.I. Kaydimov, Ibid, 1324 (1961) 14) D. Gross & A.B. Amster, 8th SympCombustn (1962), 729 15) J. Zinn & R.N. Rogers, JPhysChem **66**, 2646 (1962)
 16) P.G. Hall, TransFaradSoc **67** (2), 556 (1971) 17) R.N. Rogers, Thermochemica-Acta **187**, 1 (1972) 18) R.N. Rogers, Private Communication (1974)

Table IV
 Arrhenius Parameters Based on the Wenograd Test
 (0.018cm inner diameter tubes)

Explosive	Temp Range °K	"Direct"*		Min Tube Temp °K	Min HE Temp °K	Z** (sec ⁻¹)
		E (kcal/mole)	Z (sec ⁻¹)			
NG	555-650	35	2.3×10^{14}	555	515	$\sim 2 \times 10^{15}$
EGDN	570-645	35	2.8×10^{14}	570	530	$\sim 9 \times 10^{14}$
TNT	-	-	-	700	650	$\sim 4 \times 10^{14}$ (a)
Petrin (PE-trinitrate)	550-630	28	12×10^{11}	540	510	$\sim 4 \times 10^{12}$

*From slope of explosion time vs $1/0.93T_{\text{tube}}$ data and Eq (5), with $Q \equiv 500$ cal/g for NG, EGDN & Petrin and $Q \equiv 300$ cal/g for TNT

**From Eq (6) using min HE Temp and "direct" E
 (a) Assumed E = 41.1 kcal/mole

Refs: 1) D.A. Frank-Kamenetskii, *ActaPhys-Chim URSS* **10**, 365 (1939) 2) H. Jones, *ProcRoySoc(London)* **A189**, 415 (1947) 3) H. Eyring et al, *ChemRevs* **45** (1), 69 (1949) 4) P.L. Chambré, *JChemPhys* **20**, 1705 (1952) 5) Bowden & Yoffe (1952) 6) Bowden & Yoffe (1958) 7) A.W. Campbell et al, *PhysFluids* **4** (4), 498 (1961) 8) V.V. Gorbunov & B.S. Svetlov article in K.K. Andreev et al, "Teoriya Vzryvchatykh Veshesto" (Theory of Explosive Substances), translation FTD-MT-63-254 (1964), (Russ original 1963), 274-291 9) J. Roth, StanfordResInst Final Rept, Contract Now 65-0283-d (1966) 10) L.G. Bolkhovitinov et al, 12th SympCombustn (1969), 776 11) P.A. Persson & T. Sjölin, 5th DetonSymp (1970), 153-67 12) G.T. Afanas'ev & V.K. Bobolev, "Initiation of Solid Explosives by Impact", NASA translation TTF-623 (1971)

Kinetite (Kinetit or Kinénite-Swiss). One of the earliest gelatinous (plastic) expls which contd no NG. It was patented in 1884 by Petry and Fallenstein and was used extensively at the end of the last century in Ger and other European countries. It was prepd by gelatinizing Nitrobenzene or Nitrotoluene with Collodion Cotton, and impregnating this plastic mass with sulfur, K chlorate and other ingredients. Sulfur was later replaced by Sb pentasulfide. Its compn was: NB 16.0 to 21.0, Collodion Cotton 0.75 to 1.0, K chlorate 82.5 to 75.0, Sb₂S₅ and/or K nitrate 3.0 to 1.0%. The function of the Sb pentasulfide was to render the explosion more regular and more complete

Kinetite is very insensitive to heat, but too sensitive to impact and friction. It was not stable in storage, and sometimes expld spontaneously with no apparent cause

Refs: 1) Daniel (1902), 392 2) Colver (1918), 142 3) Marshall, *Dict* (1920), 54 4) Naóúm, NG (1928), 353 5) Giua, *Tratato VI* (1) (1959), 394

Kinite (Brit). A Dynamite consisting of NG 25-27, Ba nitrate 30-36, wood flour 30-36, Na carbonate 0.5-1.0 & Amm oxalate 0.5-10%
Ref: Giua (1958), 338

Kirsanov Explosive. A Sprengel-type expl prepd by mixing just before use, a mixt of K chlorate 80 and Mn dioxide 20%, with a mixt of turpentine 90 and phenol 10%. The solid oxidizing mixt acts as an absorbent for the liq fuel
Refs: 1) Davis (1943), 355 2) A. Pérez Ara (1945), 231

KI-Starch Test. See Abel's Test in Vol 1, p A2-L

Kittitas. Conditioning agents commonly used for reducing the tendency of AN to cake are: Kaolin or other forms of clay, and various types of Kieselguhr (qv), such as *Kittitas*, Celite & Dicalite
Refs: 1) Anon, IEC **36**, 1088 (1944) 2) Not found in CA

Kiwit. A Ger chlorate expl introduced during WWI. It contains not more than 77% Na or K chlorate, carbon carriers such as paraffin, naphthalene, vaseline, meal or oil, and not more than 15% DNT. It may contain DNT, Dinitronaphthalene, NaCl and not more than 4% Guncotton
Ref: Marshall, *Dict* (1920), 54

Kjeldahl, J. (1849-1900). Danish analytical chemist, inventor of the method for determining nitrogen in organic compounds, which is still used extensively (See below)
Refs: 1) Hackh's (1944), 470 2) S. Veibel, *JChemEduc* **25**, 459 (1949) & *CA* **43**, 776 (1949)

Kjeldahl Method. A method of detg the N in an organic compd by digesting the substance with concd sulfuric acid in the presence of catalysts such as selenium, Devarda's alloy, etc. This treatment transforms the N into Amm sulfate. By adding an excess of caustic and distg the liberated ammonia into a measured quantity of standard sulfuric acid (which is later titrated), it is possible to determine the amount of N in the substance

In using Devarda's alloy (Cu/Al/Zn-50/45/5) for N content analysis, it is advisable not to

heat the flask until the evolution of hydrogen and other gases has ceased. This minimizes the risk of initiating a hydrogen-air expln. As an added precaution, the entire app should be placed behind a safety shield (Ref 6)

Refs: 1) J. Kjeldahl, *ZAnalChem* **22**, 366 (1883) 2) W.C. Cope & G.B. Taylor, *US BurMines Tech Paper* **160**, 10-13 (1917)
3) Scott & Furman (1939), 632-35 & 2492
4) R.B. Brandstreet, *ChemRevs* **27**, 331 (1940)
5) Hackh's (1944), 471 6) W.G. Cameron, *Chem&Ind* **1948**, 158 & *CA* **42**, 3964 (1948)

Klaffke's Explosive. A blasting powder composed of K nitrate 73.9, C 13.4 & cellulose 12.7%
Ref: A. Klaffke, *FrP* 396496 (1908) & *CA* **4**, 2733 (1910)

Klepsydra. See Clepsydra under Chronographs in Vol 3, p C308-L

KMA Block. A Ger substitute expl. See under Ersatzsprengstoffe in Vol 5, p E122, Table E15

KMP (Powder). See under Plastomenite

Knallgalert. A Russ pre-WWI expl used for rock blasting contained NG 88.6, pyroxylin 6.7 & DNT 4.7%
Ref: Anon, *SS* **12**, 409 (1917)

Knallgas (Ger). An exptl mixt of H₂ and O₂, or air. The effect of initial mixt density on the initiation of detonation in knallgas and the detonation properties of "heavy" knallgas (2D₂+O₂) have been studied

Initial mixt composition ranges of knallgas and w vapor in a detonation tube were varied by controlling temps at 100, 200 & 300°, for knallgas densities of 0.64-1.8, 8.5-16 & 46-62g/liter, respectively. Ignition was by hot wire. The threshold composition decreased as initial mixt density increased. Threshold compositions were 62, 44 & ~36% knallgas at 100, 200 & 300°, or initial mixt densities

of 1.22, 13 & 63g/liter, respectively. The % knallgas reacted at final press and temp was a function of initial concn and rose abruptly at the threshold composition. The partial molal density of knallgas, which is proportional to the potential heat release per unit, increased with temp (Ref 1)

Calculated detonation properties of knallgas and heavy knallgas were compared from 1 to 15 atm using an 18ft, 1" diameter detonation tube. The detonation velocity was determined by using ionization probes to measure the time for a wave to traverse 8.984ft. Pressures were measured with an oscillogram instrumented transducer. Knallgas mixts were prepared by premixing H₂ or D₂ and O₂ and storing underground for 3-5 days. Theoretical calculations were based on Chapman-Jouguet detonation theory with assumption of equilibrium. Stable detonation velocities in heavy knallgas at 25° agreed with those predicted by Chapman-Jouguet detonation theory from 1 to 15 atm (Ref 2)

Refs: 1) J.A. Luker et al, *JChemEngData* **6**, 253 (1961) & *CA* **55**, 21590 (1961)
2) L.B. Alder et al, *JChemEngData* **6**, 256 (1961) & *CA* **55**, 21590 (1961)

Knallquecksilber (Ger). See under Mercuric Fulminate or Mercury Fulminate in Vol 6, pp F217-L to F223-L

Knallsilber (Ger). See under Silver Fulminate in Vol 6, pp F223-R to F224-R

Knallzündschnur (Ger & Swiss). Detonating Fuse or Primacord. See under Detonating Cords or Detonating Fuses in Vol 3, pp D103-R to D107-L

Knecht Compound. Knecht (Refs 1 & 2) treated cellulose with 65% nitric acid (d 1.14 g/cc) and obtained an addition product. After removing the acid retained mechanically he established that the addition compd contained nitric acid corresponding to 7.7% N. This is approximately equivalent to one NO₂ group for

every anhydroglucose unit. Drowning the addition product in w caused nitric acid to split off, and Knecht thought that it was an exceptionally labile nitrate. Häusserman (Ref 3) found it to be a rather unstable addition product. Champetier & Marton (Ref 8) examined the ultra-violet reflection spectrum, and found that it contains a band at 270–305 μ which is not present in the spectrum of NC. They considered that this supports the view that the Knecht compound is an individual substance differing from NC

Cellulose regenerated from the addition compound may demonstrate a certain degree of nitration (0.5–2.2% N). The properties of the compound are similar to those of hydro-cellulose, eg, glittering fibers, increased hygroscopicity and higher reactivity.

X-ray investigations by Hess & Katz (Ref 4) suggest that the addition product is probably compatible with the formula $C_6H_{10}O_5 \cdot HNO_3$. The X-ray diagram of the compound is a characteristic one differing from that of cellulose. They concluded that it was produced by the action of 86% nitric acid

According to the expts of Andress (Ref 5) the composition of the Knecht compound after being kept under reduced press for some time should be denoted by the formula $2C_6H_{10}O_5 \cdot HNO_3$. He demonstrated that the compound produces a characteristic X-ray fiber diagram

Later, Wilson (Ref 7) established that its composition after drying under a high vacuum is $2C_6H_{10}O_5 \cdot HNO_3 \cdot H_2O$. The product of absorption of nitric acid vapors by cellulose is, according to Wilson, not a Knecht compound, since it did not give the characteristic X-ray diagram though its chemical composition is approx that of the Knecht compound

Trogus (Ref 6) collected data concerning the concn of nitric acid to produce the Knecht compound, and concluded that it is formed when a mixt of almost equivalent quantities of the hydrates $HNO_3 \cdot H_2O$ and $HNO_3 \cdot 3H_2O$ act on cellulose

Refs: 1) E. Knecht, JSocDyers and Colourists **12**, 89 (1896) 2) E. Knecht, Ber **37**, 549 (1904) 3) C. Häussermann, AngChem **23**, 176 (1910) 4) K. Hess & J.R. Katz, ZPhysChem **122**, 126 (1926) 5) K.R. Andress, ZPhysChem **136**, 279 (1928) 6) C. Trogus, Cellulosechem **15**, 105 (1934) 7) G.L.

Wilson, Ardeer (1936), according to F.D. Miles, "Cellulose Nitrate", Oliver & Boyd, London (1955), 56 8) G. Champetier & R. Marton, BullFr **10** [5], 102 (1943) 9) Urbański **2** (1965), 321–23, 353

Knetmaschine (Ger for Kneading Machine). An apparatus for mixing solid ingredients in the presence of liquids. Several types were used in Ger for mixing proplns & expls, such as the Columnar type (Saulenknetmaschine) (Ref 2, pp 105–06; Ref 3, p 237); Werner-Pfleiderer Misch-und Knetmaschine (Ref 1, p 75; Ref 3, p 227; Ref 4, pp 585–87), and others. In France, Chaudel-Page kneaders are in general use (Ref 4, pp 588–9)
Refs: 1) Barnett (1919), 75 2) Naoúm, Expls (1927), 105–06 3) Steitbacher (1933), 227, 237 4) Urbański **3** (1967), 585–89

Kochsalzsprenngstoffe (Kitchen Salt Explosives). Ger substitute expl mixts containing a large amount of Na chloride, used during WWII. See under Ersatzsprenngstoffe (Substitute Explosives) in Vol 5, pp E121-L to E122-R

Kofler Micro Hot State Apparatus. Electrically heated apparatus which might be considered a modification and improvement of the Fisher-Johns apparatus. It permits microscopic studies of fusion, sublimation, crystallization and explosion phenomena
Refs: 1) L. Kofler, Mikrochemie **15**, 242 (1934) 2) N.D. Cheronis & J.P. Entrikin, Semimicro Qualitative Organic Analysis, T.Y. Crowell Co, NY (1947), p 36 3) A. Weissberger, Physical Methods of Organic Chemistry, 2nd edit, Part I, Interscience Publishers Inc, NY (1949), pp 78–9, 883–85 4) Arthur H. Thomas, Laboratory Apparatus & Reagents, Philadelphia (1950), pp 877–80, Catalog No 6886-A; (1974), pp 876–77, Catalog Nos 6608–H10 thru 6608-H40

Kohlen-Albit (Ger). One of the Kohlensprengstoffe (coal mining explosives). Its compn was similar to *Gesteins-Koronit*. It was used as a

permissible expl in coal mines for a short time, but because of its large flame on expln was replaced by AN expls

Refs: 1) Naoúm, NG (1928), p 428
2) Clift & Fedoroff 2 (1943), p K1

Kohlensprengstoffe (Coal Explosives). A group of Ger expls permitted for use in coal mines:

Kohlen-Carbonit. NG 25, K nitrate 34, Ba nitrate 1, flour 38.5, spent tan meal 1 & soda ash 0.5%. Q_e 506kcal/kg, Temp of Expl 1561°, Vel of Deton 3160m/sec, d 1.16g/cc, Trauzl test value 235cc, Charge limit 900g, equivalent to 501g of Brit standard Gelignite
Refs: 1) Marshall 1 (1917), 376 2) Marshall 2 (1917), 492 3) Barnett (1919), 140
4) Naoúm, NG (1928), 401

Kohlen-Koronit III. NG 4, K chlorate 68, Na chloride 14, paraffin 8, MNN 5 & wood meal 1%. OB -2.6%; Trauzl test value, 195cc
Refs: 1) Naoúm, Expl (1927), 147
2) PATR 2510 (1958), Ger 101-R

Kohlen-Salit. NG (gelatinized with NC) 12.5, vegetable meal 2.5, aromatic nitrocompounds 7.0, AN 41.0 & alkali chlorides 37.0%. OB -2.6%, Trauzl test value 260cc
Refs: 1) Naoúm, NG (1928), 411 2) Fedoroff & Clift 4 (1946), 49 3) PATR 2510 (1958), Ger 101-R

Kohlen-Silesia 4A. K chlorate 80, resin 16 & Nitroresin 4%. *Silesia No 4* contd K chlorate 80 & resin 20%
Refs: 1) Barnett (1919), 111 2) Fedoroff & Clift 4 (1946), 50

Kohlen-Westfalit I. NG 4.0, AN 83.0, K nitrate 7.0, Ba nitrate 2.0, meal 2.0 & TNT 2.0%. OB +16.4%, Trauzl test value 230cc
Refs: 1) Naoúm, NG (1928), 435 2) PATR 2510 (1958), p Ger 102-L

Kohlen-Westfalit IV. NG 3.2, AN 73.0, K nitrate 2.8, alkali chloride 15.0, meal 1.0 & DNT 5.0%. OB +8.8%, Trauzl test value 200cc
Refs: 1) Naoúm, NG (1928), 435 2) PATR 2510 (1958), p Ger 102-L

Kohlen-Westfalit V. NG 4.0, AN 83.0, K nitrate 8.0, Ba nitrate 2.0, potato meal 1.5 & Montan wax 1.5%. OB +13.5% & Trauzl test value 230cc
Refs: 1) Naoúm, NG (1928), 435 2) PATR 2510 (1958), p Ger 102-L

Kohler Powder. K chlorate 70, sulfur 20.0 & charcoal 10%. Very sensitive and dangerous mixt, similar to Berthelot's Powder (See Vol 2, p B106-L

Ref: Pérez Ara (1945), p 206

Kolax. A Ger expl of the Carbonite type contg NG 25, K nitrate 26, Ba nitrate 5, woodmeal 34 & starch 10%. *Super-Kolax* was a modification of the above used in England: NG 28.5, Collodion Cotton 1.0, K nitrate 16.5, Ba nitrate 5.0, Amm oxalate 9.5, woodmeal 30.5 & starch 9.0%. Both are no longer on the permitted list

Refs: 1) Marshall 1 (1917), 375 2) Marshall, Dict (1920), 54 3) Clift & Fedoroff 2 (1943), p K1 4) PATR 2510 (1958), p Ger 102-L

Kolfit (Ger). An expl mixt patented by H. Kolf in 1890 for use as a smokeless proplnt, but also suitable as a blasting expl. It was prepd by nitration of residues from flour mills, starch and sugar plants, distilleries, breweries, etc. Oil cakes, moss, and pine needles were also nitrated. The resulting nitrated substances were treated under 5 atm press with sulfides or polysulfides, and then mixed with saltpeter previously saturated with Nitrobenzene
Refs: 1) Daniel (1902), 394 2) Fedoroff & Clift 4 (1946), 50 3) PATR 2510 (1958), p Ger 102-L

Kolf's Blasting Powder. Ger mining expl patented in 1892. A mixt of equal parts of NC, Nitrolignin & Nitrostarch 50, Nitrosugar 38, NG 8, saltpeter 2 & aniline 2%
Refs: 1) Daniel (1902), 394 2) Fedoroff & Clift 4 (1946), p 50

Kolf's Powder. A proplnt (greenish-brown leaflets) used at the end of the 19th century in England. It consisted of equal parts of NC, Nitrostarch & Nitrolignin, gelatinized by a volatile solvent, and mixed with about 0.5% sulfur and 2% K nitrate
Ref: Daniel (1902), p 394

Kollodiumwolle. Ger & Swiss for Collodion Cotton

Kölner Dynamit Fabrik. A method, patented in 1885, of impregnating Dynamite cartridges with such materials as Al oleate in order to make them more flexible

Ref: Daniel (1902), 395

Köln-Rottweiler Sicherheits-Sprengpulver.

One of the older Ger safety expls consisting of: Amm Nitrate 93.0, vegetable oil 4.9, sulfur 1.2 & Ba nitrate 0.9%

Ref: Daniel (1902), p 395

Kolowratnik's Explosives. Chlorate expls contg PA 40, K chlorate 10–20, Na nitrate 25–35, Na carbonate 5 & woodflour 10%

Refs: 1) R. Kolowratnik, BritP 26884 (1912) & CA 8, 1672 (1914) 2) Colver (1918), 325

König Explosives. J.B. König patented in 1890 a method of prepn of expls by nitration of high bp hydrocarbons derived from the distn of coal, bituminous shales or residues of petroleum refineries, paraffins and ozokerite

Ref: Daniel (1902), 395

Konovaloff Reaction. A color test for primary or secondary nitro-compds. Samples are treated with Na hydroxide soln, the salt formed is extrd with w, and ether is added to this extr. Upon dropwise addition of ferric chloride, a red to reddish-brown color develops in the ether

Ref: E.F. Degering, "An Outline of Organic Chemistry", 4th Ed, Barnes & Noble, NY (1945), 355

Kontinuierliche Verfahren. Continuous methods, such as those of Schmid, Meissner & Biazzi, for the prepn and purification of expls and proplnts, have been used extensively in Ger. Some of these methods will be described under Nitration in Vol 8 of Encycl

Refs: 1) Stettbacher (1933), pp 174, 333
2) Stettbacher (1948), pp 60, 97 3) Stettbacher (1952), pp 82–3, 99 & 126

Koronit. One of the Ger expls of the chlorate class, developed during WWI in order to conserve NG. It contains K nitrate and/or Na nitrate 70–80, Nitroderivatives of toluene and/or diphenylamine and/or naphthalene 12–20, vegetable meal 1–5, solid hydrocarbons and/or oils and fats 3–5 & NG (not gelatinized) 2–6%

Refs: 1) Marshall 3 (1932), p 112 2) Davis (1943), 361

Koronit or Favorit is, according to Marshall (Ref 1), a Ger chlorate blasting expl. Its nonpermissible modification, *Gesteins-Koronit T1*, (See Vol 6, p G73-L) contains Na chlorate 72, DNT & TNT 20, NG 3–4, vegetable meal 1–2 & paraffin 3–4% (Ref 2). *Bebie* (Ref 3) and Warren et al (Ref 4) list this expl under the name *Coronit* (See Vol 3, p C543-R). The permissible modification, *Kohlen-Koronit* (qv), contains according to Ref 1, not more than 68 parts of K or Na chlorate, not more than 12 parts of aromatic hydrocarbons or nitrocompds (but no trinitrocompds), not more than 4 parts Blasting Gelatin, not more than 4 parts of powdered coal, with the remainder consisting of Na chloride, paraffin, etc

These expls were eventually replaced by *Perkoronits*, which are similar to *Koronits* except that they contain perchlorates rather than chlorates

Refs: 1) Marshall, Dict (1920), 55 2) Naoúm, NG (1928), p 428 3) *Bebie* (1943), p 52 4) F.A. Warren et al, "Chlorates and Perchlorates, Their Manufacture and Uses", NAVORD Report 7147, Vol 1 (1960), p 205 (Contract NOrd 18471)

Koronit V. A Ger permissible Dynamite contg NG 4, K chlorate 65, Na chloride 14, naphthalene 10, MNN 5 & woodmeal 2% (Ref 1). According to Marshall (Ref 2), the name *Koronit* was given in 1931 to *Chloratit I* (See Vol 2, p C209-L), which contains K and/or

Na chlorate 70–80, Nitroderivatives of toluene and/or naphthalene and/or diphenylamine 12–20, vegetable meal 1–5, solid hydrocarbons and/or oils and fats 3–5 & NG (not gelatinized) 2–6%

Refs: 1) Naoúm, Expls (1927), 147
2) Marshall **3** (1932), 112 3) PATR **2510** (1958), p Ger 102-R

Kostevich, Michael M. (1877–1957). A former Colonel of the Imperial Russian Guard Artillery and head of the Russian chemical warfare section during WWI. After the revolution he worked in Engl, Fr and Belg. He built and directed a chemical laboratory for the Czech Skoda works. From 1930–1936 he taught chemistry at the Technical Institute in Paris. From 1937 he was chief of the research department in the explosives plant at Villa Maria, Argentina. Author of numerous publications on ordnance and expls including books entitled, "Trinitrobenzol and Trinitrotoluol" and "Methods for Removing Explosives from Artillery Shells by Burning"

Ref: A.A. Schrimppff, SS **32**, 319 (1937)

Kraft Dynamite. Patented by C.G. Bjorkmann at the end of the 19th century. It contained NG 55.36, K chlorate 16.96, K nitrate 15.18 & pulverized cork 12.50%

Ref: Daniel (1902), 396

Kraft Paper. A strong, relatively inexpensive paper made primarily from pine by digestion with a mixt of caustic soda, Na carbonate, Na sulfate & Na sulfide (Ref 3). It is used extensively in Dynamite cartridges (Ref 2) and in pyrotechnic flare and signal cases (Ref 1)

Refs: 1) S.M. Kaye et al, "New Flare Case Materials", PATR **3215** (1965) 2) Blasters' Hdb (1969), 30–33 3) CondChemDict (1971), 499-L

Kraftzahl (KZ or Strength Number). It has been recognized for some time that enlargements in the lead block cavity, obtained in the Trauzl test (See Vol 1, pp XXV–XXVI), are not exactly proportional to the power of

the expls. For this reason, the Trauzl test has been the subject of numerous investigations, principally by Kast, Selle, Neubner (Refs 1, 2 & 3), and at the US BurMines (Ref 5)

In the course of these investigations, Neubner (Ref 3) found that better results are obtained if, instead of firing a standard 10g charge, the weights are varied until expansions between 250 and 325cc are obtained. The weight (w) corresponding to a 300cc expansion is calculated by interpolation. By dividing 300 by w and multiplying by 10, a value is obtained which is more representative than the old Trauzl value. This new value is called the Kraftzahl or KZ of the expl. The following table compares these values with older Trauzl test values determined by various investigators (Kast, Stettbacher, Zschokke, Will & Brunswig):

Explosive	Trauzl Block Expansion (cc)	
	Old Value	KZ Value
Nitromannite	650	675
Blasting Gelatin	520–610	554–575
NG	515–563	540–545
Nitropentaerythrite	460	500
Gelatin Dynamite (60%)	410	465–472
Tetranitroanisol	390	440
Guhr Dynamite	350	419
NC (13% N)	325–420	400–426
Tetryl	340–350	405
TNB	330	386
Hexanitrodiphenylsulfide	325	380
Hexanitrodiphenylamine	320	376
Picric Acid	300–365	376–385
TNT	285–300	350–353
Trinitroresol	275	336
Dinitrobenzene	250	311
Single-base Propplt (13% NC)	150	226
Double-base Propplt (40% NG)	150	226
Lead Azide	115	165
Mercuric Fulminate	110–150	226
Black Powder	30–112	95

Refs: 1) H. Kast, SS **15**, 171 (1920)
2) H. Kast & H. Selle, Glückauf, **1927**, 900
3) R. Neubner, SS **15**, 3, 53–4, 82, 126, 162, 194 (1928) 4) Marshall **3** (1932), 143 5) N.A. Tolch & G.St.J. Perrott, "The Trauzl Block Strength Test of Dynamites", US BurMines RI **3039** (1930)
6) Stettbacher (1948), 113

Kratites. Expls containing Amm Perchlorate, NG and NC in various proportions, based on requirements for strength, brisance, sensitivity, etc

Refs: 1) Daniel (1902), 396 2) Pérez Ara (1945), 219

Kreulen's Aluminum Block. See Aluminum Block (of Kreulen) in Vol 1, p A145-L

K-Salz (Ger). See under Cyclonite in Vol 3, p C611-L

KSG Powder. An older Brit 33-grain sporting smokeless powder which is no longer used
Ref: Marshall 1 (1917), 327

KS Powder. An older Brit 42-grain sporting smokeless powder which is no longer used
Ref: Marshall 1 (1917), 326

K₃-Stoff (Ger). A highly dispersed silica, prepd by a special process, used during WWII in some "Tetan" expls
Ref: G. Römer, "Reports on Explosives (Germany)", PBL Rept No 85160 (1946), p 3

Ksilil (Russ, Xylite in Fr, Ksylit in Polish, TNX). A term given to commercial Trinitro-xylene (TNX) which consists chiefly of the trinitro derivatives of meta-, with some ortho- and para-xylenes. It is a greyish-yellow substance prepd by the nitration of commercial xylene by mixed nitric-sulfuric acid. It is insol in w. Ksilil is slightly more sensitive to initiation, and about as sensitive to impact and bullet test as TNT. It was used in composite expls as a partial substitute for TNT
Refs: 1) PATR 2145 (1955), p Rus 10-L 2) Gorst (1957), 100 3) Urbański 1 (1964), 396

Kubin Explosives. A safety expl, patented in 1893, containing AN 75-95 and Nitroaniline

25-5%. It could also contain up to 20% of added Amm oxalate, chlorate or sulfate. Other nitrated amines, such as those of toluene, xylene or naphthalene, could be used in lieu of aniline

Ref: Daniel (1902), 397

Kubin & Sierch. Patented in England in 1884 a safety expl consisting of a regular Dynamite to which was added 20-50% of Amm chloride or sulfate. This expl can be considered as an early *Wetterdynamite*

Ref: Daniel (1902), 398

Kumuliatwnyi Zariad (Shaped Charge). Mixts containing Geksogen (RDX) or TEN (PETN) with TNT or other expls or phlegmatizers were used in Russ shaped charges
Ref: Gorst (1957), 95, 98 & 100

Küp Powder. A mixt containing Ba nitrate 80, sulfur 20%, plus charcoal
Ref: Daniel (1902), 398

Kurzschlusszünder. Ger short-circuit primers or igniters, such as the Schaffler, Reinecke systems as well as the Eindrahtzünder (single wire igniters) are described in the *Ref*
Ref: Beyling-Drekkopf (1936), pp 216-22

Kynarkite. An early permitted expl containing NG 25, woodmeal 35, Ba nitrate 3, K nitrate 28, Amm oxalate 5 & w 3.7%. BalPend value for 4oz sample, 2.21" swing compared to 3.27" for Brit 60% Gelignite. Charge limit in gallery test 20oz
Refs: 1) Barnett (1919), 135 2) Marshall, Dict (1920), 55-6

Kynite. A Brit safety expl invented by A.T. Cocking of Kynoch, Ltd: NG 25-27, Ba & K nitrates 30-36, woodmeal & starch 40-43 & Na carbonate (added) 0.5%. To this could be added 0.5 to 10% Amm oxalate
Refs: 1) Daniel (1902), 398 2) Marshall, Dict (1920), 56

Kynite, Condensed. Brit safety expl manufd by Kynoch, Ltd and packaged in a non water-proof parchment paper wrapper: NG 24-26, starch 32.5-35.0, woodmeal 2.5-3.5, Ba nitrate 31.5-34.5 & Ca carbonate 0 to 0.5%
Refs: 1) Daniel (1902), 398 2) Thorpe 2 (1917), 438 3) Marshall, Dict (1920), 56

Kynoch Gelignite. Gelignite manufd by Kynoch, Ltd in England. It contained NG 54-63, Collodion Cotton 3-5, K nitrate 26-34 & woodmeal 6-9%
Ref: Daniel (1902), 340

Kynoch Limited. A Brit expls company with plants at Kynochtown (Essex) and Ferrybank Arklow (Ireland). This company prospered

greatly during the South African War of 1901, when holders of its preferred stock received dividends equal to 7 times the price of the stock. At that time, the company manufd Dynamite, Gelignite, NC, Kynite, Cordite & Smokeless Pdr, as well as various munitions
Ref: Daniel (1902), 309

Kynoch Smokeless Powder. One of the older Brit 30-grain sporting powders. It contains NC 52.1, DNT 19.5, K nitrate 1.4, Ba nitrate 22.2, woodmeal 2.7, ash 0.9 & volatiles 1.2%.
 Q_c 807cal/g; gas vol 726 l/kg at STP
Refs: 1) Marshall 1 (1917), 327 2) Barnett (1919), 86 3) Thorpe 4 (1949), 530

KZ. See Kraftzahl in this Vol

L

L-Alloy. A Rus fusible expl consisting of 95% TNT and 5% Trinitroxylylene, mp 74°. It has an expl power similar to that of TNT, although it differs from the latter in detong more readily due to the fact that during the cooling process very fine TNT crystals are formed

Refs: 1) Ya.I. Leitman (according to A.G. Gorst), "Porokha i Vzryvchatyiye Veshchestva", Oborongiz, Moskva (1949) 2) Urbański 3 (1967), 248-49

Labels for Shipping Explosives and Other Dangerous Materials. The US Interstate Commerce Commission Regulations specify that the following labels be provided when expls or other dangerous materials are shipped or transported:

Flammable liquids: diamond-shaped label, **bright red** in color, with each side measuring 4". Printing must be in black letters inside of a black line border, measuring 3.5" on each side

Flammable solids and oxidizing materials: same shape, size and lettering as above, but the color shall be **bright yellow**

Corrosive liquids, alkalis or acids: same shape, size and lettering as above, but the label shall be **white** in color

Compressed gas: same shape, size and lettering as above, but the color of the label shall be **red** for flammable gases and **bright green** for nonflammable gases

Poison (gas, liquid or solid) and tear gases: same size and shape of label as above, but with a **white** label with letters in **red**

Explosives, propellant powders and special fireworks: rectangular white labels with **red** letters reading **Explosives A** or **Explosives B**

Radioactive materials (Groups I or II): diamond-shaped label, **white** in color, with each side measuring 4". Printing is in **red** letters inside a red-line border. Group I materials are those which emit any gamma radiation, either alone or with electrically charged particles or corpuscles (alpha, beta, etc). Group II materials are those which emit neutrons and either or both of the types of radiation characteristics of Group I materials

Radioactive materials (Group III): same as above except that the lettering and border line are in blue. Group III materials are those which emit electrically charged corpuscular rays only

(alpha, beta, etc), or any other that is so shielded that the gamma radiation at the surface of the package does not exceed 10 milliroentgens per 24 hours at any time during transport

For more detailed information, consult the ICC Regulations (Ref 1) or Ref 2

Refs: 1) Agent T.C. Georges Tariff No 19, published by Interstate Commerce Commission Regulations for Transportation of Explosives and other Dangerous Articles by Land and Water in Rail Freight Service and by Motor Vehicle (Highway) and Water, including Specifications for Shipping Containers; issued 5 Aug 1966; available from T.C. George, 63 Vesey Street, New York, NY 10007 2) Sax (1968), 308-62

Labile Nitrocellulose (Knecht Compound). Knecht found that when cotton is immersed in 60% nitric acid, it forms a "labile" nitrate from which the nitric acid can be removed by washing with w. Using an acid with a d of 1.415, he obtained a cellulose with 35.8% absorbed acid, corresponding to $C_6H_{10}O_5 \cdot HNO_3$

Refs: 1) E. Knecht, Ber 37, 549 (1904)

2) Marshall 1 (1917), 151

NOTE: See Cellulose Nitrates in Vol 2 of Encycl, pp C100-Lff

Lactic Acid Nitrate (Nitrolactic Acid), $CH_3CH(ONO_2)COOH$; mw 135.09, N 10.37%; light yellowish oil misc with w, alc, eth & benz; insol in ligroin. May be prepd from lactic acid using Zn acetate in a mixt of fuming nitric and concd sulfuric acids. Decomps at RT, too unstable for use

Refs: 1) Beil 3, 279 2) A.H. Blatt & F.C. Whitmore, "A Literature Survey of Explosives", OSRD 1085, 56 (1942)

LACTOSE AND DERIVATIVES

Lactose (Milk Sugar), $C_{12}H_{22}O_{11} \cdot H_2O$; mw 360.31, monoclinic spheroidal crystals (from w), mp 201-202° (becomes anhydr at 120°), bp (dec), d 1.53g/cc at 20°. Present in the milk of mammals, and is produced commercially from whey, a by-product of the cheese industry.

It is hydrolyzed by dil mineral acids to glucose and galactose. Termansen (Ref 2) found that a homogeneous mixt of lactose with 12.5% PETN is not expl, however, lactose contg 12.5% Hexanitromannitol has expl props. Lactose yields expls on nitration (See below)

Refs: 1) Beil 31, 407 2) J.B. Termansen, ArchPharmChem 59, 713-41 (1952) & CA 47, 319 (1953) 3) Merck (1968), 605
4) CondChemDict (1971), 502-L

Lactose Hexanitrate, $C_{12}H_{16}O_5(ONO_2)_6$; a white amorphous material with mp about 70° , was isolated from the alc mother liquors in the crystn of the octanitrate (Ref 6). It is a less powerful expl than the octa-compd

Sjöberg, in 1888, patented expls contg mixts of nitrolactose, nitromolasses and Na nitrate, as well as admixts of the above with Amm nitrate, naphthalene and paraffin. These expls were unduly heat sensitive (Ref 2). Crater patented the use of nitrolactose with materials such as MF and K chlorate, or LA or DDNP in blasting cap charges (Ref 4), as well as its utilization together with oxidizers such as Amm nitrate in blasting expls (Ref 5)

Refs: 1) Beil 31, 418 1a) W. Will & F. Lenze, Ber 31, 82 (1898) 2) Daniel (1902), 558-59 3) A. Pictet & H. Vogel, CR 185, 332 (1927) 4) W. deC. Crater, USP 1759565 (1930) & CA 24, 3649 (1930) 5) W. deC. Crater, USP 1945344 (1934) & CA 28, 2538 (1934) 6) Davis (1943), 242 7) Blatt OSRD 2014 (1944)

Lactose Octanitrate (Nitrolactose),

$C_{12}H_{14}O_3(ONO_2)_8$; mw 702.31, N 15.96%, OB to CO_2 -9.1%, white monoclinic needles (from methanal), mp $145-46^\circ$ (dec), bp (ignites at $246-48^\circ$), d 1.684g/cc; insol in w, sol in acet, methanol and AcOH; sl sol in cold alc, sol in hot; reduces Fehling's soln on warming

May be prepd by stirring lactose with mixed nitric-sulfuric acids until the mass forms a solid agglomerate [1p lactose in 15p acid, consisting of 1 vol nitric (d 1.5) and 2 vols concd sulfuric]. The mixt is transferred to ice w and pulverized under w. The product may be purified by crystn from alc (Ref 1)

Nitrolactose is comparable in brisance (sand crush test) to Tetryl, but has a lower vel of

deton (4225m/sec as detd in $1.25'' \times 8''$ cartridges). Its sensitivity to impact is comparable to PETN, and it is fairly insensitive to friction and insensitive to static electricity. The thermal stability of Nitrolactose is satisfactory; 65.5° KI test - 28 minutes; loss on heating for 8 days at 50° - 0.7%; at 75° for 24 hours - 1%; 54 hours - 23%; at 100° for 10 hours - 20% loss (Ref 7)

Lafaye Explosives. Lafaye patented in Fr in 1888, a method of prepg NC from pure wood cellulose, the resulting product being cheaper than NC obtained from cotton
Ref: Daniel (1902), 400

Lafin and Rand Powder Co. One of the first expl manufg companies in the USA. Its first BlkPdr plant was erected near Orange, NJ in 1808 (Ref 1). Another plant was built at Orange Mills, near Newburgh, NY, and a plant at Pompton Lakes, NJ, manufd proplnt pdr for small arms. It consisted of Guncotton 67.25, NG 30 and metallic salts 2.75%, glectinized with acetone. A dense shotgun pdr of similar compn was also made (Ref 2). The Pompton Lakes, NJ plant was purchased by duPont and expls including initiators, such as MF, LA, blasting caps, etc were manufd there
Refs: 1) Daniel (1902), 400 2) Marshall, Dict (1920), 56 3) VanGelder & Schlatter (1927), 98

Lake's Explosives. Mining expls patented in Engl in 1894. Typical formulations included:

- 1) Na nitrate 76, nitronaphthalene 8 & nitrophenol 16%
- 2) Na nitrate 58, nitronaphthalene 8 & nitrophenol 34%
- 3) Na nitrate 74, nitrophenol 10, sulfur 8, charcoal 4 & rosin 4%

Ref: Daniel (1902), 401

Lambotte Explosives. Complicated mixts of nitroglucose, sawdust, Pb oxide, Ba sulfate, etc
Ref: Daniel (1902), 401

Laminac 4116. A binder and adhesive most often specified for use in pyrotechnic flares and signals. It is a proprietary product manufd by the American Cyanamid Co, and belongs to the class of thermosetting alkyd-styrene resins more commonly called unsaturated polyesters (with added styrene). Since the liq resin is relatively low in viscosity, it can be added to solid powds without any volatile solvent. For activation, 1–2% of methyl ethyl ketone peroxide (tradename **Lupersol DDM**) is mixed with the resin. This “catalyst”, actually a curing agent that reacts chemically, converts the resin first into the gel state, then in strongly exothermic reaction into a hard solid. The reaction is accelerated by the promoting agent Co naphthenate (tradename **Nuodex**). Laminac is usually admixed as 4–9% of the formula wt
Refs: 1) D. Anderson & E. Freeman, “The Kinetics of Thermal Degradation of the Synthetic Styrenated Polyester, Laminac 4116”, *JApplPolymerSci* **1**, 192 (1959) 2) D. Anderson & E. Freeman, “Characterization of Saturated Polyesters by Differential Thermal Analysis”, *AnalChem* **31**, 1697 (1959)
 3) V. Hogan & S. Gordon, “Pre-ignition and Ignition Reactions of the Propagatively Reacting System Magnesium-Sodium Nitrate-Laminac”, *Combstn&Flame* **3**, No 1, 3–12 (1959)
 4) *EngrDesHdbk*, “Military Pyrotechnics Series, Part Three – Properties of Materials Used in Pyrotechnic Compositions”, **AMCP 706-187** (Oct 1963), 157–58 5) G. Weingarten, “Polymerized Laminac Resin 4116 – Heats of Formation and Combustion, and Carbon, Hydrogen, Oxygen Content”, *PATR* **3032** (1963)

Laminated Powders. Progressive burning proplnts originated by the Fr during WWI and used in large caliber guns. One of these powds was prepd as follows: A quantity of Ballistite, prepd by mixing 50p of NG with 50p of NC (12% N), was rolled between heated rollers until a sheet of desired thickness was obtained. Another portion, consisting of 50p of DNT and 50p of NC (12% N), was rolled to form a sheet thinner than the previous one. A strip of the first mixt was sandwiched between two strips of the second mixt, and the ensemble combined into a laminated product by pressing

between warm rollers. In the resulting “laminated” product, the outer layers burned relatively slowly with a temp of about 1500°, while the inner slab burned rapidly with a temp of about 3000°. Similar proplnts were prepd during WWII

Ref: Davis (1943), 318

Lamm Explosives. Lamm patented, in 1888 in Fr, the use of waxes, such as carnauba, as coating agents for hygroscopic ingredients of expls. He also proposed several expl mixts contg DNB in combination with K or Amin nitrates

Ref: Daniel (1902), 401

LaMotte's Explosive. DNN 7p and TNT 5p were fused together and mixed with 88p of Amm nitrate. After the mixt cooled, 2p of pyrites were added

Ref: E. LaMotte, USP 911019 (1909) & CA **3**, 1088 (1909); *BritP* 7921 (1908) & CA **3**, 2382 (1909)

Lance Missile (XMGM-52A). US surface-to-surface missile weighing approx 2814 lbs with a 30 mile range. It is launched from a converted M113 armored personnel carrier chassis, and is intended as a divisional support weapon. As such it will replace the **Honest John** and **Sergeant** rockets. It is powered by a storable liq fuel rocket motor and guided by a simple inertial system. It has a small nuclear warhead, but other types are also available. An extended range Lance is under development with a 50–60 mile range. The Sea Lance XMGM-52B is a marine conversion for firing from a gyroscopically stabilized launcher

Refs: 1) E. Luttwak, “A Dictionary of Modern War”, Harper & Row (1971), 120 2) F.O. DuPre, *Ordn* **57**, 271-L (Jan-Feb 1973)
 3) Anon, *Ordn* **57**, 501-R (May-June 1973)

Land. One of the raised ridges in the bore of a rifled gun barrel.

Note: The caliber of small-arms ammo, except for shotgun ammo, is expressed as the diameter

of the bore of the weapon in inches. Thus, caliber .30 ammo is intended for a weapon having a bore of 0.30 inch diameter across the lands and, although the outside diameter of the bullet is a few thousandths of an inch greater than the bore diameter, it is customary to speak of this ammo as caliber .30. The same is applied to the bore of the gun

Refs: 1) Ohart (1946), 64 & 98 2) Ord-TechTerm (1962), 172-R

Landauer Explosives. Fr expls, patented in 1891, in which chlorates and perchlorates are desensitized by coating them with fatty materials, tar or nitrated hydrocarbons. Following are some expl mixts proposed by Landauer: 1) K chlorate 48.8, tar 24.4, DNN 24.4 & sulfur 2.4%; 2) K chlorate 20, tar 20, NC 40 & coconut oil 20%; 3) K chlorate 22.2, tar 55.6 & NG 22.2%; 4) K perchlorate 3, tar 1, DDN 10, NC6, NG 75 & sawdust 5%; 5) K perchlorate 2.0, tar 18.4, DNN 4.0, K nitrate 42.9 & Amm nitrate 32.7%

Ref: Daniel (1902), 402-403

Land Mines. See Mines (Military) in Vol 8, of Encycl

Landsdorf Dynamite. Dynamite contg NG 75, kieselguhr 20 & Amm urate 5%

Refs: 1) Daniel (1902), 403 2) Fedoroff & Clift 4, 51 (1946)

Landsdorf Powder. BlkPdr type compn contg K nitrate 73, Amm urate 9, charcoal 9 & sulfur 9

Ref: Daniel (1902), 403

Landskrona Powder. Swiss proplnt, invented by E. Schenker before 1890 and manufd in Landskrona, Sweden. It was made by gelatinizing pure NC with amyl acetate, and was used by the Swiss and Danish armed forces
Ref: L. Gody, "Traite des Matières Explosives", Namur (1902), 641

Lanthanum Triazide. See in Vol 1 of Encycl, p A554-R

Laser, Application to Explosives and Weapons Technology. A device used for the amplification or generation of coherent light waves, the term *laser* being an acronym for *light amplification by stimulated emission of radiation*. Unlike the waves emitted by an ordinary light source, such as an electric lamp, the laser produces a light beam that does not diffuse. Moreover, a laser organizes the energy waves emitted by a stimulated atom so that they travel in the same direction, at the same frequency, and perfectly in step with the stimulating radiation. This property is known as coherence. A laser thus produces a very narrow band of frequencies similar to that of a radio oscillator, but in the infrared and visible-light portions of the spectrum (Ref 15)

The highly parallel, intense beam of coherent radiation emitted by the laser has found a multitude of important applications in the military area. These range from anti-missile applications, communications, surveillance, range finding (ground and airborne), tracking (ground, sea, air), weather reconnaissance, metal working, nondestructive measurement, defensive and offensive weaponry, to field surgery (Refs 1, 16, 27 & 29)

Picatinny Arsenal adapted the laser for remote, wireless initiation of thermal batteries and other devices contg expls, proplnts and pyrotechnics in expts to demonstrate the feasibility of using a thin beam of infrared radiation in lieu of a method requiring wires. The wires, which can act as an antenna to the detriment of the device contg them, were removed and replaced by a thin transparent window to provide an optical path between the laser beam and the reactive material to be initiated. Reportedly offering a savings in the cost of thermal batteries and squibs, the method also contributes to increased safety in environments which could cause undesired ignition. The laser beam, programmed to deliver a series of pulses as required, can be directed thru the air on a line-of-sight path or thru a maze of fiber optics in any direction dictated by the geometry of the equip-

ment used. Upon striking the expl material, the pulse excites electronic and vibrational energy levels, causing it to ignite (Ref 3)

A laser-initiated pyrotechnic system (Zr-Amm perchlorate) for spacecraft application has been shown to be superior to conventional electroexpl initiation (Ref 22). Primary high expls such as LA and LSt can be initiated directly. Q-switched-mode lasers can directly deton PETN, RDX, and Tetryl in a properly designed device and can be useful where micro-second simultaneity is important (Ref 6)

A "hardened" laser optic system that resists X-rays was developed by Space Ordnance Systems, Inc, to assist missiles in reaching their target. The system can withstand very high temps and the tremendous bursts of X-rays from high altitude thermonuclear explosions which may be used to destroy incoming ballistic missile warheads. The X-rays would be released by defensive missiles fired in the general vicinity of incoming weapons. Called LEED, an acronym for *laser energized explosive device*, the system was developed to end the danger of premature expln or failure of proplnts or pyrotechnics in the presence of radiofrequency, electrostatic energy, X-rays, or dense electron fields. If, while still in their high-energy state, the X-rays released from a nuclear expl impact upon a warhead, they are quickly stopped and their electromagnetic energy is converted into heat energy. The resulting surge of energy might shatter the outer casing of the warhead and create a shock wave that could damage the interior mechanisms. LEED, constructed of low "Z" materials, utilizes a laser energy pulse transmitted along nonmetallic, fiber optic conductors instead of conventional connecting metallic electrical cables, bridgewires, and spark gaps such as those used in interior warhead mechanisms (Ref 2)

The US Army (Ref 29) successfully tested a laser-guided artillery shell that could revolutionize the role of artillery on the battlefield. With the new shell, whose course can be changed in flight to bring it down on a target with high accuracy, artillery would have, for the first time, a capability of attacking moving targets, such as tanks

The guided projectile homes in on a target in the following manner. A forward artillery

observer, either on the ground or in an aircraft, trains a laser beam on a target. A laser-seeker in the nose of the artillery shell, which is fired in the general vicinity of the target, picks up the laser spot on the target. On the basis of information received from the laser-seeker, a guidance system sends out course directions to fins that deploy after the shell leaves the gun barrel. The fins then change the course of the shell so it will hit the target

On the basis of test firings, accuracies on the order of 1-3 ft at any range can be obtained with this shell, compared with a probable error of 45-60 ft with conventional 155mm ammo. The shell can be used in the 155mm howitzer with no modifications to the artillery piece

Another area of laser use applied to expl materials involves its employment to excite Raman spectra for studies of crystal structure, lattice dynamics, phase transitions and vibrational mode frequencies. Comps studied include TiN_3 (Refs 10, 17 & 23), NaN_3 (Ref 18), KN_3 and RbN_3 (Ref 4), NH_4N_3 (Ref 7), BaN_3 (Refs 5, 8 & 24), LA (Ref 9), HMX (Ref 25), RDX (Ref 11) and Amm perchlorate (Ref 26)

In the course of an investigation to provide bright light sources of min volume and weight, a search was conducted for new sources of chemically generated light. Chemical systems were investigated in a flash photolysis laser apparatus in order to discover new output wave lengths and new molecules which produce lasing (Ref 12)

The principle of using the products and energy from an expl detonation to produce a population inversion suitable for lasing has been studied. The design of a 175mm disposable laser detonation cartridge (LDC) was explored, and it was predicted that the energy stored in 30 grams of expl can be converted into a 60 kilojoule laser pulse with a one millisec pulse duration. A program is outlined to construct a prototype LDC and to measure its performance (Ref 19)

Lasers have also been employed to study fast chemical reactions, those taking place in the time domain of a few billionths of a second. Capellos et al at PicArnsn, have employed Q-switched Ruby and neodymium lasers, which provide an intense pulse of monochromatic

light of 347 and 265nm, respectively, with time durations of the order of 12 nanoseconds. The ultra-violet light induces electromagnetic excitation in molecules absorbing the laser energy, and by subsequently applying the principle of absorption spectroscopy, kinetic and spectroscopic information relating to the electronically excited states of various energetic molecules have been derived. The systems studied to-date include s-TNB, s-TNT, triphenylamine, and mono- as well as di-nitronaphthalenes (Ref 13, 14, 20, 21 & 28)

Written by S. M. KAYE

Refs: 1) D. Fishlock, Ed, "A Guide to the Laser", MacDonal, London (1967), 68-84 (*The Laser on the Battlefield*) 2) Anon, Ordn 52, 298 (Nov-Dec 1967) 3) Expls&Pyrots 3, No 10 (1970), 2 4) Z. Iqbal, JChemPhys 53, 3763 (1970) 5) Z. Iqbal, C.W. Brown & S.S. Mitra, JChemPhys 52, 4867 (1970) 6) L.C. Yang & V.J. Menichelli, ApplPhysLet 19, 473-75 (1971) 7) Z. Iqbal & M.L. Malhotra, SpectrochimActa 27A, 441 (1971) 8) Z. Iqbal & M.L. Malhotra, JChemPhys 55, 528 (1971) 9) Z. Iqbal, W. Garret, C.W. Brown & S.S. Mitra, JChemPhys 55, 4528 (1971) 10) Z. Iqbal & M.L. Malhotra, JChemPhys 57, 2637 (1972) 11) Z. Iqbal et al, PATR 4401 (1972) 12) M.Y. DeWolf Lanzerotti, "Chemical Laser Research", PATR 4354 (1972) 13) C. Capellos & K. Suryanarayanan, "Microsecond Flash Photolysis of 1,3,5-Trinitrobenzene Solutions and Product Formation with 254nm Steady State Illumination", PATR 4342 (1972) 14) K. Suryanarayanan & C. Capellos, "Flash Photolysis of 2,4,6-Trinitrotoluene Solutions", PATR 4407 (1972) 15) Encycl Britannica 13, 733-34 (1973) 16) L. Goldman, "Applications of the Laser", CRC Press, Cleveland, Ohio (1973), 121-26 (*Lasers in the Military*) 17) Z. Iqbal, "Advances in Raman Spectroscopy", Heyden, London, Chapt 23 (1973) 18) Z. Iqbal, JChemPhys 59, 1769 (1973) 19) J. Hershkowitz & M.Y. DeWolf Lanzerotti, "Preliminary Design Study For An Explosive Product Laser", PATR 4465 (1973) 20) C. Capellos, "Nanosecond Flash Photolysis of Triphenylamine Solutions", PATR 4439 (1973) 21) C. Capellos & K. Suryanarayanan, "A Ruby Laser Nanosecond Flash Photolysis System, 1,4-Dinitronaphthalene", PATR 4445

(1973) 22) L.C. Yang et al, National Defense 58, 344-47 (1974) 23) C. Christoe & Z. Iqbal, Solid State Comm 15, 859 (1974) 24) Z. Iqbal, JChemPhys 61, 1230 (1974) 25) Z. Iqbal et al, JChemPhys 60, 221 (1974) 26) H. Prask et al, ProcArmySciConf (1974) 27) Anon, National Defense, Vol LIX, No 327 (Nov-Dec 1974), 195, 243 & 257 28) C. Capellos & G. Porter, JCS 70, FaradayTransII, 1159-64 (1974) 29) J.W. Finney, "Artillery Shell Guided by Laser", The New York Times (Jan 29, 1975), 1 & 17

Latent Heats of Fusion, Vaporization. See under Heat, Latent in this Vol of Encycl, p H58-R

Launchers. See Vol 2 of Encycl, p C28-R (Rocket Launcher) and Vol 6 (1974), p G139-R (Grenade Launcher) & G185 (Guided Missile Launcher)

Launoy Powder. A mixt of Na nitrate, sawdust, nitrated bran and sulfur
Ref: Daniel (1902), 423

Lava Fire Bomb. USA incendiary bomb developed during WWII, designated as M74. It weighs 10 lbs and consists of a hexagonal pipe 19" long, inside of which is a plastic cup filled with "synthetic lava" consisting of GOOP (Mg pdr coated with asphalt particles), white P and other ingredients. When clusters of these bombs are impacted on targets, their burning contents flow much like volcanic lava
Ref: Anon, ArmyOrdn 29, 208 (1945)

Lavoisier, A.L. (1743-1794). Fr Chemist, regarded as the father of modern chemistry by virtue of his study of combstn and the role of oxygen. He formulated the theory of the conservation of matter, and laid the basis for chemical nomenclature. From 1775 to 1791 he was in charge of expl manufg in Fr ("Regisseur des Poudres"). He was unjustly accused and executed during the Fr revolution
Ref: Hackh's (1944), 481-R; (1969), 381-R

LAW. Acronym for *light assault weapon*. The USA M72 66mm anti-tank rocket-launcher weighs 4.5 lbs with one unguided rocket, and has a range of 500–600 yds. The disposable launcher-rocket package is 25" long and extends to 34" for firing

Ref: E. Luttwak, "A Dictionary of Modern War", Harper & Row (1971), 40–41 & 120

Lead (Plumbum). Pb, at wt 207.19, bluish-white, silvery, gray metal, mp 327.4°, bp 1740°, d 11.34 at 20°/4°, d at mp 10.65. Highly lustrous when freshly cut, tarnishes upon exposure to air; very soft and malleable, easily melted, cast, rolled and extruded. Occurs chiefly as sulfide in galena (86.8% Pb), also as carbonate in cerussite (77.5% Pb) and as sulfate in anglesite (68.3% Pb). May be prepd by roasting and reducing Pb ores. Sol in hot concd nitric acid, in boiling concd HCl or sulfuric acid, in acet ac. Attacked by pure w, weak organic acids in the presence of O. Resistant to tap w, HF, brine & solvents (Ref 2)

Its general uses as a metal are innumerable (Ref 2). In the manuf of expls it is used, in either pure or alloy form, in many types of equipment such as nitrators, drying pans, bearing metal, pipes, tanks, etc. In ammo, it is used as the core of bullets, shrapnel balls and shot, and for the prepn of oxides and salts used in expl and pyrotechnic mixts

One of the most recent uses for Pb is the addition, in the form of foil or coil of wire, to proplnt pdr as a decoppering agent for the bore of the gun. The Pb is placed between the proplnt charge and the projectile

Pb is highly toxic by inhalation of dust or fumes. Tolerance, 0.2mg/cc in air. A cumulative poison, FDA regulations require zero Pb content in foods (Refs 3 & 4)

Refs: 1) Gmelin, Syst Nr 47, Teil C, Lfg 1 (1969), 1ff; Teil A1 (1973), 6ff 2) E.J. Mullarkey, IEC 49, 1607 (1957) 3) Merck (1968), 611-R 4) Sax (1968), 863 5) Cond-ChemDict (1971), 507-R

Lead Acetates. See in Vol 1 of Encycl, pp A28–29

Lead Aceto-Bromate. See in Vol 1 of Encycl, p A29–I

Lead Aceto-Chlorate. See in Vol 1 of Encycl, p A29-L

Lead Aceto-Perchlorate. See in Vol 1 of Encycl, p A29-L

Lead Aceto-Sodium Perchlorate. See in Vol 1 of Encycl, p A29-L

Lead Acetylde. See in Vol 1 of Encycl, p A76-R

Lead-Antimony (For Use in Ammunition). Material used by the USA Armed Forces for the manuf of bullet cores, base fillers and point fillers. Three grades are covered in specification MIL-L-13283B (MR) (19 Aug 1970) with the following compn requirements:

	Grade 1	Grade 2	Grade 3
Lead + antimony, %	99.2	99.2	99.2
Antimony, %	1.0–2.5	9.0–10.5	9.0–9.1
Copper, %, max	0.10	0.10	0.10

The material shall be clean and of uniform compn, and shall be free from segregations, dross, oxides, blow holes, hard spots, foreign material and other injurious defects. The material shall be furnished in commercial cylindrical ingots of specified dimensions

Refs: 1) Gmelin, Syst Nr 47, Teil 3 (1970), 905ff 2) Spec, "Lead-Antimony" (For Use in Ammunition), MIL-L.13283(MR) (19 Aug 1970)

Lead Azide. See in Encycl, Vol 1, A545–A587 *Addnl Refs:* 1) B. Reitzner, "Influence of Silver Coatings on Ignition Behavior of Colloidal Lead Azide", PATR FRL-TR2 (1960), PB148915 2) B. Reitzner, "Influence of Water on Thermal Decomposition of Alpha

Lead Azide", PATR FRL-TR5 (1960), PB-148916 3) J.I. Bryant & M.D. Kemp, AnalChem 32, 758-60 (1960) (Polarographic analysis) 4) B. Reitzner, J.V.R. Kaufman & E.F. Bartell, JPhysChem 66, 421-26 (1962) [Decompn of alpha LA] 5) H.W. Voight Jr & F.H. Schmitt, PATM 1673 (1965) (Low-impulse LA film to be used in applications calling for light-initiated plane wave explosives) 6) Spec, "Lead Azide (Special Purpose, For Use in Ammunition)", MIL-L-14758 (10 May 1968) 7) Anon, "Lead Azide RD-1333", US Spec MIL-L-46225C (26 Aug 1968) 8) P.G. Fox, J.M. Jenkins & G.W.C. Taylor, "Spontaneous Explosions in Lead Azide Solutions", Explosivst 17, No 8, 181-84 (Aug 1969) 9) G. Cohn, Ed, Expls&Pyrots 3 (3) (1970) (Scanning electron microscopic examination of pure, dextrinated and RD 1333 LA) 10) L. Avrami & N. Palmer, "Impact Sensitivity of Lead Azide in Various Liquids with Different Degrees of Confinement", PATR 3965 (1969) 11) M.F. Zimmer & L.D. Lyston, "Dynamic Pressure Measurements on Small Amounts of Detonating Lead Azide", Explosivst 18, No 1, 12-15 (Jan 1970) 12) R.W. Hutchinson, S. Kleinberg & F.P. Stein, "Effect of Particle-Size Distribution on the Thermal Decomposition of α -Lead Azide", JPhysChem 77, No 7, 870-875 (1973) 13) Director, Explosives Research and Development Establishment, Waltham Abbey, Essex, England [Abstract reported by G. Cohn, Ed, Expls&Pyrots 7 (4) (1974); New Lead Azide compns RD 1343 & RD 1352]

Lead Azidodithiocarbonate. See in Vol 1 of Encycl, p A637-L

Lead Bichromate. See Lead Dichromate in Vol 3 of Encycl, C284-R

Lead Block Compression Test. See under Compression (or Crusher) Tests for Determination of Brisanice in Vol 3 of Encycl, C492-L to C493-L

Lead Block Expansion Test. See under Trauzl Test in Vol 1 of Encycl, XXV-XXVI

Lead Bromate (Monohydrate). $\text{Pb}(\text{BrO}_3)_2 \cdot \text{H}_2\text{O}$; mw 481.06, colorless crystals, mp (decomp at 180°), d 5.53g/cc; sl sol in cold w, moderately in hot w. *Poisonous!* Pure Pb bromate is not dangerous, but when prepd by the action of Pb acetate on an alkali bromate, the unstable **diaceto-diplumbo-bromate** is always present. This complex explodes violently on heating, striking or rubbing
Refs: 1) Gmelin, Syst Nr 47, Teil C2 (1969), 374ff 1a) E. Güzel & E. Marcus, ZAng-Chem 38, 929 (1925) 2) I. Victor, ZAng-Chem 40, 841 (1927) & CA 21, 3324 (1927) 3) Anon, Chem&Ind 46, 690 (1927) & CA 21, 3170 (1927) 4) Merck (1968), 612-R 5) Sax (1968), 864-L 6) CondChemDict (1971), 508-R

Lead Carbonate. See in Encycl 2 (1962), C59-L

Lead Carbonate, Basic. See in Encycl 2 (1962), C59-L

Lead Chlorate (Normal). See in Encycl 2 (1962), C188-R

Lead Chlorate (Basic). See in Encycl 2 (1962), C189-L

Lead Chlorite. See in Encycl 3 (1966), C245-R

Lead Chromate. See in Encycl 3 (1966), C280-L

Lead Dichromate. See in Encycl 3 (1966), C284-R

Lead 2,4-Dinitroresorcinate (LDNR). See in Encycl 5 (1972), D1274-R

Lead 4,6-Dinitroresorcinate, Basic. See in Encycl 5 (1972), D1275-R

Lead Hydroxide-2,4,6-Trinitroresorcinate. See in Encycl 5 (1972), D 1277-L

Lead Imide. See in Encycl 1 (1960), A169-L

Lead Mononitroresorcinate. See in Encycl 5 (1972), D1271-L

Lead Nitrate. See under Nitrates in Vol 8 of Encycl

Lead Nitroaminoguanidine. See in Vol 1 of Encycl, p A212-R

LEAD OXIDES

Lead Oxide, Yellow, or Litharge (Lead Monoxide, Lead Protoxide or Plumbous Oxide). PbO , mw 223.21, yellow to yellowish-red, heavy, odorless pdr or minute, cryst scales; mp 888° , bp (vol at red heat); d 9.53g/cc; insol in w, alc; sol in acet ac, dil nitric acid, in warm solns of fixed alkali hydroxides. It may be prepd in the lab by heating Pb nitrate, carbonate or hydroxide; commercially, it is made by heating Pb to a temp considerably above its mp and continually skimming off the litharge produced. It is used in some primer comps

Litharge is toxic as a dust. Wear dust mask, and wash thoroughly before eating or smoking. Keep away from feed or food products

Refs: 1) Gmelin, Syst Nr 47, Teil C, Lfg 1 (1969), 51ff 1a) Mellor (1946), 705
2) EngDesHdbk, "Properties of Materials Used in Pyrotechnic Compositions", **AMCP 706-187** (Oct 1963), 161-65 3) Merck (1968), 613-R 4) Sax (1968), 865-6 5) Cond-ChemDict (1971), 510-R

Lead Oxide, Brown or Lead Dioxide (Lead Superoxide or Peroxide). PbO_2 , mw 239.21, dark brown tetragonal crystals, mp (dec to PbO and O_2 at 290°), d 9.38g/cc. May be prepd from Pb acetate and Ca hypochlorite. Insol in w and alc; sol in acet ac and hot alk

It is an extremely strong oxidizing agent, so care must be taken in mixing or storing with comb materials. When PbO_2 is gently

rubbed with sulfur or red phosphorus, the mass ignites. It is used with amorph P as an ignition surface for matches, and in pyrotechnic applications (Ref 5). Anderson, in 1908, proposed its use as an additive to expls to increase their power; for example 1) PA 40 & PbO_2 60%; 2) PA 20, TNT 10, Guncotton 15, NG 10 & PbO_2 45%. Colver (Ref 1a) had considerable doubt as to the safety of mixts of this type. McNutt (Ref 2) proposed using PbO_2 in primer mixts, for example, PbO_2 25, Pb dinitrophenolazide 15, Ba nitrate 30, Sb trisulfide 18, Ca silicide 6 & TNR 6%

The USA military specification (Ref 6) details the following requirements for Type I (low alkalinity), Type II (high alkalinity), Class 1 (subsieve) and class 2 (100 mesh, nominal) PbO_2

Composition

	Type I	Type II
Lead dioxide, min, %	95.0	95.0
Water-soluble salts, max, %	0.05	0.05
Acidity	None	None
Alkalinity as Na_2CO_3 , max, %	0.01	0.10
Ammonium salts	None	None

Particle Size Distribution

Percent Maximum	Class 1	Class 2
Retained on a No 100(149 micron) sieve	—	0.1
Retained on a No 140(105 micron) sieve	—	10.0
Retained on a No 200 (74 micron) sieve	0.0	—
Retained on a No 325 (44 micron) sieve	5.0	—
Larger than 20 microns	20.0	—
Smaller than 5 microns	15.0	—

Refs: 1) Gmelin, Syst Nr 47, Teil C, Lfg 1 (1969), 147ff 1a) Colver (1918), 324
2) J.D. McNutt, USP 1906394 (1933), USP 1930653 (1933), USP 2009556 (1935)
3) EngDesHdbk, "Properties of Materials Used in Pyrotechnic Compositions", **AMCP 706-187** (Oct 1963), 169-70 4) Merck (1968), 613-L 5) Ellern (1968), 51, 60, 246, 280
6) Anon, "Lead Dioxide, Technical", **MIL-L-376B** (Feb 1968) 7) Saks (1968), 865-66
8) CondChemDict (1971), 509-L

Lead Oxide or Lead Tetroxide (Minium, Red Lead, Mineral Orange, Mineral Red, Plumbo, Puce, Orthoplumbate, Paris or Saturn Red).

Pb_3O_4 , mw 685.63, bright red scales or amorph pdr, mp (dec betw 500–30°), d 8.32 to 9.16 g/cc; insol in w and alc, sol in acet ac and hot HCl. May be prepd by carefully heating unfused litharge at 470–80° for several hours in a current of air. The hot pdr acquires a deeper tint, becoming violet and then black. On cooling, the color changes to red. Used as an oxidizer in pyrotechnics and as an ingredient in some expls, eg, in the Austrian expl "Lederite" to the extent of 20%

The USA military specification (Ref 3) contains the following chemical requirements:

	% by Weight	
	Minimum	Maximum
Assay as Pb_3O_4	98.0	—
Insoluble matter in nitric acid	—	0.10
Water-soluble substances	—	0.05
Carbon compounds (as C)	—	0.010
Manganese (Mn)	—	0.0005

Lead oxide is highly toxic as a dust. Use with adequate ventilation, and keep away from food and food products

Refs: 1) Gmelin, Syst Nr 47, Teil C, Lfg 1 (1969), 122ff 1a) EngDesHdbk, "Properties of Materials Used In Pyrotechnic Compositions", AMCP 706-187 (Oct 1963), 166–68 2) Ellern (1968), 197 3) Anon, "Lead Oxide, Red, Analyzed Reagent", MIL-L-51336 (Nov 1969) 4) Sax (1968), 865–66 5) CondChemDict (1971), 510-R

Lead Perchlorate. See under Perchlorates

Lead Picrate. See under Picrates

Lead Plate Test for Detonators. See under Plate Tests for Explosives

Lead Salts of Nitrocompounds. Hopper (Ref), at PicArns, prepd and characterized Pb dinitroresorcinate, Pb dinitrophenolate, and Pb dinitrophthalate as possible substitutes for MF in priming compns. Only the dinitroresorcinate

salt was found suitable. He also prepd and studied the expl props of Pb Trinitro-N-methylnitramine Resorcinate & Phenolate, and Pb Trinitrobenzoate for possible use as deton agents. All were unsatisfactory

Ref: J.D. Hopper, "Study of Lead Salts of Nitrocompounds as Substitutes for Mercury Fulminate", PATR 480 (1934)

Lead-Shot Metal. An alloy of Pb and As. The As content may range from 0.3 to 0.8% and may be added either in the form of white As or arsenical dross. The As imparts a greater fluidity to the metal and increases its tendency to assume a spherical shape in passing thru the air when dropped from the top of a Pb shot tower into cold w. About 0.025% Na sulfide is added to the w in order to prevent oxidation of the shot

Ref: CondChemDict (1950), 393-R; not found in later editions

Lead-Sodium Thiosulfate. (Lead-sodium Hyposulfite, Sodium-lead Trithiosulfate). $Na_4Pb(S_2O_3)_3$, mw 635.59, white, small, heavy crystals, mp (dec at 30–40°); sparingly sol in w; readily sol in Na acetate or Na thiosulfate solns. May be prepd (Ref 1) by mixing solns of Na thiosulfate and Pb acetate, followed by alc addition. On concg the soln, the liq separates into two layers. The bottom layer is removed and treated with more alc, whereupon the mixt solidifies to a white, amorph, gelatinous mass of variable compn. On diln, the amorph mass turns cryst, which on drying, corresponds to the above formula. It is used in the prepn of matches. *Poisonous!*
Refs: 1) Mellor 10 (1934), 551 2) Merck (1968), 614-L 3) Ellern (1968), 76 & 78 4) Sax (1968), 865–66 5) CondChemDict (1971), 511-R

Lead Stearate. See under Stearates

Lead Styphnate. (Lead 2,4,6-Trinitroresorcinate). See Encycl 5, D1277-Lff

Lead Styphnate, Basic. (Lead Hydroxide Styphnate, Lead Hydroxide-2,4,6-Trinitroresorcinate). See *Encycl* 5, D1277-L

Lead Sulfocyanate. See Lead Thiocyanate

Lead Tetraethyl (Tetraethyl lead, Lead Tetraethide, Tetraethyl Plumbane). $\text{Pb}(\text{C}_2\text{H}_5)_4$, mw 323.45, colorless liq, fr p -136° , bp about 200° , also stated as 227.7° with decompn, d 1.653g/cc at 20° ; insol in w; sl sol in alc, sol in benz and eth. May be prepd by the action of Pb chloride on Zn ethyl or on a Grignard reag. Used extensively as an anti-knock addition to gasoline, and has been proposed by Fr investigators as a flash reducer in proplnts (Ref 2)

Refs: 1) *Beil* 4, 639, (591) & [1018]
2) A. Demougin, *MP* 25, 139 (1932-33)
3) Merck (1968), 1025-L 4) Sax (1968), 870-L 5) *CondChemDict* (1971), 856-57

Lead Thiocyanate (Lead Sulfocyanate, Lead Rhodamide). $\text{Pb}(\text{SCN})_2$, mw 323.38, white, odorless pdr, mp (dec $190-95^\circ$), d 3.82g/cc; sol in about 200p cold, 50p boiling w; sol in alkali hydroxide and thiocyanate solns. May be prepd by the action of a sol Pb salt (acetate or nitrate) on K thiocyanate (Ref 1). It has found extensive use in stab priming and ignition mixts. Examples are: 1) priming mixt: $\text{Pb}(\text{SCN})_2$ 25, Sb_2S_3 17, LA 5 & KClO_3 53%; 2) igniting mixt: $\text{Pb}(\text{SCN})_2$ 45 & KClO_3 55% (Ref 2)

The requirements of the USA armed forces are covered by a military specification (Ref 3) which contains the following criteria: (1) form - discrete crystals, (2) color - white or yellow, (3) granulation - 100% shall pass thru US standard sieve No 140 (105 microns), and 75% thru sieve No 325 (44 microns), (4) Pb as $\text{Pb}(\text{SCN})_2$, 99.3% min, (5) thiocyanate as $\text{Pb}(\text{SCN})_2$, 99.3% min, (6) chloride, as PbCl_2 , 0.20% max, (7) Na, as thiocyanate, 0.20% max, (8) moisture, 0.20% max, and (9) insoluble matter, 0.20% max

Refs: 1) *Beil* 3, 157, (68) & [116]
2) Ellern (1968), 54 & 353 3) Anon, "Lead Thiocyanate (Sulphocyanate)", *MIL-L-65A* (12 Feb 1968)

Lead Trinitroresorcinate. See under Trinitroderivatives of Dihydroxybenzene in Vol 5 of *Encycl*, pp D1277-Lff

Leaking Gun. Brit for recoilless gun. See *Encycl* 2, (1962), C28-R

Ref: J. Corner, "Theory of the Interior Ballistics of Guns", Wiley, NY (1950), 243

Lecithin. A mixt of the diglycerides of stearic, palmitic and oleic acids, linked to the choline ester of phosphoric acid. Yellowish-white, waxy mass, obtained either from egg yolk or soybeans. Insol in w; sol in alc, chl and eth. Lecithin was used in Composition C (RDX 88.3, nonexpl oily plasticizer 11.1 & lecithin 0.6%) to help prevent the formation of large crystals of RDX which would increase the sensitivity of the compn (Refs 1 & 4)

Lecithin used by the USA armed forces is covered by a military specification (Ref 3) contg the following requirements: (1) moisture, 1.0% max, (2) benz insol matter, 0.1% max, (3) acid no, 24 max, (4) acetone insoluble matter, 68% min, and (5) Lecithin, 19.0% min
Refs: 1) O.E. Sheffield, "Handbook of Foreign Explosives", *FSTC 381-5042* (Oct 1965), 67-8
2) Merck (1968), 615-L 3) Anon, "Lecithin (For Use in Explosives)", *MIL-L-3061B* (June 1969) 4) Anon, "Properties of Explosives of Military Interest", *EngDesHdbk AMCP 706-177* (Jan 1971), 53-4 5) *CondChemDict* (1971), 513-R

Lécorché-Jovinet Sensitivity Test. Test for the stability of proplnts contg NG. Any nitrous acid present is absorbed by diethyldiphenylurea to form ethylphenylnitrosamine, which can be detected by testing with α -naphthylamine-HCl

Ref: H. Lécorché & P.L. Jovinet, *CR* 187, 1147-8 (1928) & *CA* 23, 3345 (1928)

LEDC. See Low Energy Detonating Cord

Lederite. An older Austrian mining expl contg K nitrate 45, red lead (Pb_3O_4) 20, leather scrap 18, sulfur 15 & PA 2%

Ref: Daniel (1902), 404

LEED. Acronym for Laser Energized Explosive Device. See under Laser

Lennard-Jones, Devonshire Equation of State.

Derived for gases at high d , in terms of interatomic forces, using statistical mechanics. The atom in a dense gas was considered similar to that in a liq or cryst, subject to multiple collisions at all times (Ref 1). This method was later extended to liqs (Ref 2) and solids (Refs 3 & 4), and was used by Murgai and others for the calcn of the expl properties of TNT and PETN (Refs 5 & 6)

Refs: 1) J.E. Lennard-Jones & A.F. Devonshire, *PrRoySoc* **A163**, 53-70 (1937) & *CA* **32**, 1533 (1938) 2) *Ibid* **A165**, 1-11 (1938) & *CA* **32**, 6118 (1938) 3) *Ibid* **A169**, 317-38 (1939) & *CA* **33**, 4098 (1939) 4) *Ibid* **A170**, 464-84 (1939) & *CA* **33**, 9071 (1939) 5) M.P. Murgai, *JChemPhys* **21**, 1403-4 (1953) & *CA* **47**, 11738 (1953) 6) *Ibid*, *Proc-IndianAcadSci* **39A**, 176-84 (1954) & *CA* **48**, 1322 (1954)

Note: See *Encycl* **4**, pp D287-L to D288-L

Le Marechal Powders. Prepd by mixing finely pulverized K, Na or Amm chlorate (about 84%) with molten stearic or palmitic acid (about 16%). After cooling, the mass was pulverized and mixed with a small quantity of finely powdered charcoal, which served to increase the flammability of the product. The resulting expl was loaded into cartridges by extrusion

Ref: Daniel (1902), 404

Lenite. A mixt of PA and collodion cotton

Ref: Daniel (1902), 404

Leonard's Smokeless Powders. Several varieties of proplnt manufd at the end of the 19th century by the Leonard Smokeless Powder Co of Manchester, NJ, using as one of the ingredients, urea dissolved in acet. Typical compns contd: 1) NG 31.6, Guncotton 52.6, lycopodium 10.5 & urea 5.3%; 2) NG 70.1, Gun-

cotton 23.3, lycopodium 4.7 & urea 1.9%. For use in cannon, these powds were mixed with about 3.5% cottonseed oil as a water-proofing agent

Refs: 1) Daniel (1902), 405 2) VanGelder & Schlatter (1927), 859

Leonit (Leonite). Ger permissible Dynamite contg NG 4, K perchlorate 35, AN 10, Na nitrate 3, crude TNT 11, woodmeal 7 & alkali chloride 30%

Refs: 1) M. Giua, "Dizionario di Chimica", Torino (1951), 166 2) B.T. Fedoroff et al, "Dictionary of Explosives, Ammunition and Weapons" (German Section), *PATR* **2510** (1958), 107-R

Lesmok Powder. One of the older American sporting powds manufd by DuPont

Ref: Marshall **1** (1917), 330

Le Sueur's Explosive. Prepd by mixing 12.5p of molten paraffin wax with 11p sulfur and 54p Na nitrate. After cooling, the mixt is granulated thru a screen and blended with 22.5p of pulverized K chlorate

Ref: E.A. Le Sueur, *USP* 923435 (1909) & *CA* **3**, 2227 (1909)

Leuschel Explosives. Ger expls prepd by impregnating moss with glucose, starch, sugar or glycerin solns, drying the mixt and nitrating the resulting product

Ref: Daniel (1902), 405

Levoglucosan Trinitrate. See under Fructosan Trinitrates, Vol **6** of *Encycl*, F208-L

Levulose Trinitrate. See under Fructose, Vol **6** of *Encycl*, F208-L

Addnl Refs: 1) Beil **1**, (460) 2) H.A. Lewis, *USP* 1947530 (1934) & *CA* **28**, 2538 (1934) 3) *Ibid*, *CanP* 340567 (1934) & *CA* **28**, 4234 (1934)

Lewin Explosives. Patented in Fr in 1887, consisting of nitrated residues of cane sugar plants, either alone or mixed with NG, NC, Na nitrate, rye flour, paraffin, tar, etc. They were also known as "Sandhoulites"

Ref: Daniel (1902), 406

Lewisite (L). Dichloro (2-chloro-vinyl) arsine. ClCH:CHAsCl_2 ; mw 207.35, dk-grn oily liq, fr p -18° , bp 190° , liq d 1.89 at 20° , vap d 7.2 (compared to air), decompn temp (above 100°). Vap press 0.087mm Hg at 0° , 0.394mm at 20° , 32.50mm at 100° . Volatility 967mg/m³ at 0° , 2300mg/m³ at 20° , 8890mg/m³ at 30° . Odor, usually geranium-like, very little odor when pure. Flash p, none; rapidly hydrolyzed in liq or vap state to HCl and chlorovinyl-arsenious oxide. The later is a nonvol blister-forming solid not readily washed away. L is stable in steel or glass containers

In use, a moderately delayed-action casualty gas. A "blister gas", toxic lung irritant and systemic poison. It produces immediate and strong stinging sensation of the skin

Refs: 1) Anon, OrdTechTerm (June 1962), 68-R 2) Anon, "Military Chemistry and Chemical Agents", TM 3-215 (Dec 1963), 26-27

Note: See Encycl 2 (1962), C168-R

Lezinsky's Explosive. A mixt of whole wheat flour 27p with resin 53p is treated with 20p nitric acid and, without washing, combined with 100 to 300p of K chlorate

Ref: G. Lezinsky, USP 909915 (1909) & CA 3, 1088 (1909)

L.F. Dynamites. Abbr for Low-Freezing Dynamites. See Vol 5 of Encycl, D1584-L & D1588-R to D1593-L

L.G. Powder. Brit abbr for Large Grain BlkPdr formerly used in cannons

Ref: Daniel (1902), 406

Liardet Explosives. Liardet of Australia pa-

tented, between 1889 and 1894, several expls named "Nico Powder" and Acme Powder (Encycl 1 (1960), A93-R)

Ref: Daniel (1902), 5 & 406

Lichenin (Moss Starch). $\text{C}_6\text{H}_{10}\text{O}_5$; mw 162.14, mp 10° . White gelatinous mass, resembling starch in props. Sl sol in cold w; sol in boiling w giving a colloidal soln and sol in HCl. On nitration it yields an expl, Lichenin Pentanitate (qv)

Refs: 1) Beil, not found 2) Karrer (1947), 357 3) Dorée (1947), 435 4) Merck (1968), 618-R 5) CondChemDict (1971), 515-6

Lichenin Pentanitate. $\text{C}_{12}\text{H}_{15}\text{O}_5(\text{ONO}_2)_5$; mw 549.28, white solid, N 12.75% (theory), 12.40% (found). May be prepd by method described by Reilly (Ref 2) as follows: At RT with stirring, gradually add 1p of finely powd lichenin to 50p of a mixt consisting of 3p by wt of H_2SO_4 (d 1.84) and 1p of HNO_3 (d 1.50). Stop the agitation, allow the nitrate to settle, and decant the supernatant liq. Pour the ppt and remaining spent acid into ice w. Filter and purify the pentanitate, first by boiling in sl acidic w, then in sl alkaline w, and finally with neutral distd w. Dry at a low temp

Lichenin Pentanitate is insol in w, eth and benz; readily sol in acet, et acet and amyl acet; sol in eth-alc mixts. It is an expl compd, decompg at high temps, giving off oxides of nitrogen

Refs: 1) Beil, not found 2) Reilly (1938), 42

Liebert. Patented in 1889 in Fr, a method of nitrating glycerin with mixed nitric-sulfuric acids in the presence of Fe sulfate or AN

Ref: Daniel (1902), 407

Liebert Dynamites. Low-freezing dynamites prepd from NG mixed with 3-5% iso-amylic alc nitrate. It was claimed that these were more powerful than those prepd from NG alone

Ref: Daniel (1902), 407

Life of Guns. See under Erosion of Gun Barrels in Encycl 5 (1972), E112-R to E120-R

Ligdyn. A South African Dynamite contg NG 40, Na nitrate 45, woodmeal 13 & wheat flour 2% (Ref 2). An expln of 4210 lbs of Ligdyn in 1913 was reported caused by friction in a packing machine (Ref 1)

Refs: 1) A.B. Denne, JSCI 32, 627 (1913) & CA 7, 3229 (1913) 2) Marshall 1, 362 (1917)

Light, Effect on Explosives. Many expls undergo slight changes in compn when subjected to direct light, especially sunlight or ultraviolet radiation. Mitra & Shrinivasan (Ref 5) studied the effect of sunlight on thin layers of TNT and Tetryl. In the case of TNT, they noted a lowering of its mp, a reduction in sensitivity, and a color change from light buff to yellow-orange to dark brown with continued exposure. Tetryl exhibited a mp decrease with no change in sensitivity. Nitrous fumes were evolved and exposed surfaces became brown, but much more slowly than for TNT. Krauz and Turek (Ref 1) noted a TNT mp decrease from 81.4° to 73.5° after 4 months direct sunlight exposure, and extracted Trinitrobenzoic acid and Trinitrophenol as breakdown products

Urbański (Ref 6) followed the photochem decompn of NG, NC (11.9% N) and Hexogen on exposure to UV radiation by the liberation of iodine from K iodide soln, and derived rate equations. NG continued to decomp even after the UV source was removed, becoming increasingly acidic, and was judged less stable than NC. The NC rate of decompn remained constant with time. NC evolved oxides of N₂, became acidic, and was finally judged useless as an expl material. Hexogen, although changing color from white to yellow, produced no volatile products capable of oxidizing K iodide

Münzinger (Ref 2) exposed pure NC to sunlight and noted only slight yellowing after several months. However, NC contg gelatinizers such as castor oil or tricresyl phosphate was affected in a matter of days, yellowing and becoming less sol in et acet or acet

Diazodinitrophenol (DADNPh) was found

to be stable for long periods of time in diffused light. Samples standing in the laboratory, protected from direct sunlight, showed no signs of discoloration after 6 months. In direct sunlight, however, DADNPh darkened rapidly eventually acquiring a dark brown color. To detn the effect of exposure on its expl strength, DADNPh samples subjected to from 0 to 20 hours of sunlight were fired in a Sand-Test bomb. The results showed that DADNPh undergoes no loss of strength on one hour exposure, with no marked decrease even after 3 to 5 hours, despite a marked darkening in color (Ref 3)

Eggert (Ref 8) and McAuslan (Ref 7) reported on the initiation of explosions by light. Evidence was presented for photochemical and/or photothermic effects in various nitrides, azides, acetylides and perchlorates

Refs: 1) C. Krauz & O. Turek, SS 20, 49 (1925) & CA 19, 2747 (1925) 2) W.M. Münzinger, ChemZtg 56, 851-52 (1932); abstracted in Chim&Ind 29, 783D (1933) 3) L.V. Clark, IEC 25, 667 (1933) 4) Kast-Metz (1944), 247 5) B.N. Mitra & N. Shrinivasan, JSciIndRes 6B, No 2, 31-5 (1947) & CA 41, 5723 (1947) 6) T. Urbanski, RocznikiChem 21, 120-23 (1947) & CA 42, 4856 (1948) 7) J.H.L. McAuslan, ProcRoySoc A246, 248 (1958) 8) J. Eggert, JPhysChem 63, 11-15 (1959) & CA 53, 12680 (1959)

Light Emission (Luminosity Effects) from Detonations and Explosions. See "Detonation (and Explosion), Luminosity (Luminescence) Produced on" in Encycl 4, (1969), D425-L to D434-L, and "Detonation (and Explosion); Spectra and Spectrographic Measurements in", D548-R to D549-L

Light, Production of. See under Pyrotechnics

Lightning Protection. It is policy in the USA to install lightning protection on bldgs and structures used for manufg, processing, handling or storing expls, ammo, expl ingredients, and other hazardous materials, particularly where

operations cannot be shut down during electrical storms and personnel evacuated

Approved lightning protection systems are the integrally mounted system, the separately mounted shielding system (mast type), and the separately mounted shielding system (overhead ground wire). Details of all of these systems are described in the Ref

The purpose of these installations is to provide a metal path of low resistance for the discharge of electrical currents from the air to the ground without damage to the structure or contents. These systems also serve to prevent the charging of structural metal components as a result of induction when lightning strikes nearby

Ref: Anon, "Safety, Safety Manual", AMCR 385-100 (April 1970), Chapt 8, 8-1 to 8-36

Lignin. A polymer found in wood (25–30%). The structure of the lignin monomer is still not completely known. Its similarity to coniferyl alcohol, noted more than 75 years ago (Ref 1), is confirmed by the fact that it can be oxidized to vanillin and hydrogenated to compds of the cyclohexylpropyl type. Lignin is removed from wood by both the sulfate and soda paper pulp processes, and limited amts have been recovered from these sources and other wood waste. It has been used as a component of Dynamites, and has been nitrated

Refs: 1) P. Klason, *SvenskKemTid* 9, 133 (1897) 2) F.F. Nord & W.J. Shubert, *SciAm* 199, No 4, 104–13 (1958) 3) F.E. Brauns & D.A. Brauns, "The Chemistry of Lignin", Academic Press, NY (1960) 4) I.A. Pearl, "The Chemistry of Lignin", Marcel Dekker, NY (1967) 5) *CondChemDict* (1971), 516-R

Lignin Nitrate (Nitrolignin). A general term employed to designate nitrated products contg lignin, such as wood, straws, jute, esparto grass, flax and hemp fibers (Ref 1)

The earliest expts devoted to the nitration of lignin, previously isolated from woodpulp by means of HCl, were reported by Hägglund (Ref 3). Lignin mixed with fuming nitric acid

was heated on a w bath until the lignin was completely dissolved, whereupon the nitration product was pptd by dilg the soln with w

Fischer and Schrader (Ref 4) nitrated lignin by treating it with 31.5% nitric acid at RT, completing the operation with moderate heating. Only 4.3% N was found in the prod, to which the formula $C_{39}H_{29}O_{21}N_3(OCH_3)_3$ was assigned on the basis of analysis. At the same time, König (Ref 5) nitrated lignin at low temp to obtain a prod contg 3% N

Powell and Whittaker (Ref 6) nitrated lignin with mixed nitric-sulfuric acids at $-5^{\circ}C$, and isolated the nitration prod by pptn with ice and w. It was a red powd with the empirical compn $C_{42}H_{39}O_{13}(NO_2)_3$

Kürschner et al (Refs 7, 8 & 11) prepd nitrolignin by direct nitration of wood pulp. A soln of nitric acid (d 1.40) in alc was used at the temp of boiling alc. Under these conditions cellulose remained unchanged. Lignin, on the other hand, was nitrated and dissolved in the alc soln. Nitrolignin was then separated from the soln with w, in the form of an amor yellow powd. The yield of nitrolignin was 15–17% of the wt of wood pulp. According to the type of wood used to prepare the lignin, the N content of the fully nitrated prod varied from 3.0 to 4.5%. On the basis of his own expts, Kürschner suggested the following functional compn for nitrolignin:

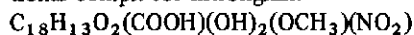

In order to separate lignin from carbohydrates, stronger reagents were used in the expts of Friese et al (Refs 9 & 12) for the nitration of wood pulp, namely normal mixed acids. In this way nitrolignin with a higher N content was obtained. When nitric-sulfuric acids (1:2 ratio) were used, a prod contg 8.45% N was obtained with a yield of 55%

Although nitrolignin was used in early propnlts, mining expls and sporting powds (Refs 1 & 2), Urbafski (Ref 14) states that it is unsuitable for manufg nitro compds likely to be of practical value as expls

Lignin Dynamites. Mixts prepd by impregnating sawdust with NG were known by this name. They sometimes contd metallic nitrates
Ref: Daniel (1902), 408

Refs: 1) Daniel (1902), 559, 706–08
 2) E. Durnford, "Manufacture of Nitrolignin and Sporting Powder", Whittaker & Co, London (1912) 3) E. Haggglund, *Arkiv-ChemiMinerGeol* **7**, 20 (1918) 4) F. Fischer & H. Schrader, *BrennstoffChem* **2**, 217 (1921) 5) F. König, *Cellulosechem* **2**, 93, 105, 117 (1921) 6) W.G. Powell & H. Whittaker, *JCS* **125**, 357, 364 (1924) 7) K. Kürschner, *ChemZtg* **48**, 461 (1924); *BrennstoffChem* **6**, 117, 177, 188 (1925); *JPraktChem* [2], **118**, 238 (1928); *Cellulosechem* **12**, 281 (1931); *ZellstoffFaser* **32**, 17, 81, 87 (1935), *Ibid* **33**, 1, 49, 121 (1936) 8) K. Kürschner & F. Schindler, *ZellstoffFaser* **33**, 121 (1936) 9) H. Friese & H. Fürst, *Ber* **70**, 1463 (1937) & *CA* **31**, 6869 (1937) 10) R.S. Hilpert, W. Krüger & G. Hechler, *Ber* **72B**, 1075–82 (1939) & *CA* **33**, 5813 (1939) 11) K. Kürschner & K. Wittenberger, *Cellulosechem* **18**, 21 (1940) 12) H. Friese & W. Lüdecke, *Ber* **74**, 308 (1941) & *CA* **39**, 4547 (1941) 13) K. Freudenberg, W. Lautsch & G. Piazolo, *Cellulosechem* **21**, 95–6 (1943) & *CA* **38**, 5081 (1944) 14) Urbański **2**, 435 (1965)

Lignite (Brown Coal). A brownish-black coal in which the alteration of vegetable matter has proceeded further than in peat, but not as far as in sub-bituminous coal. There is no sharp distinction between these three materials, but in general, lignite is denser, darker in color, and contains more C than peat. Lignite consists of w 9–12, vol comb matter 31–38, fixed C 27–43, and ash 5–20% (Ref 3)

Lignite in powd form has been used as a component of blasting expls, for example, Explosive of Kolowratnik (1912) contains PA 45, Na nitrate 40, sawdust 9 & lignite 6% (Ref 1). Marcusson (Ref 2) nitrated lignite with fuming nitric (d 1.52) and mixed nitric-sulfuric acids. The prod was sol in acet, and consisted of various nitrocompds

Refs: 1) Colver (1918), 325 2) J. Marcusson, *ZAngChem* **34**, 521–2 (1921) & *CA* **16**, 1496 (1922) 3) *CondChemDict* (1950), 398; (1971), 516-R

Limiting Charge. See Charge Limit or Limit Charge in *Encycl* **2** (1962), C151-R to C153-L

Limiting (or Critical) Charge Density-Diameter of Explosive Charges. See Detonation Velocity-Charge Diameter and Density Relationship in *Encycl* **4** (1969), D641-L to D656-L

Limparicht Explosives. According to Daniel (Ref 2), the following compds were patented in 1888 as expls, but do not appear to have found any practical application:

- 1) **Barium m-Triazobenzene Sulfonate**, $(N_3C_6H_4SO_3)_2Ba$; needles which expl at 130° (Ref 1)
- 2) **Potassium m-Triazobenzene Sulfonate**, $N_3C_6H_4SO_3K$; very unstable, expl at about 130°
- 3) **Barium Triazobenzene Disulfonate**, $N_3C_6H_3(SO_3)_2Ba$
- 4) **Barium Triazobrombenzene Sulfonate**, $(N_3C_6H_3BrSO_3)_2Ba$
- 5) **Sulfodiazobenzoic Acid**, $HOSO_2(N_2)C_6H_3COOH$; very sensitive to shock and heat
- 6) **Sulfodiazobrombenzoic Acid**, $HOOC C_6H_2Br(SO_3H)N_2$; more sensitive to shock than previous compd
- 7) **Hydrazinobenzenedisulfonic Acid**, $H_2NNHC_6H_3(SO_3H)_2$

Refs: 1) Beil **11**, 80 2) Daniel (1902), 408

Limpet Charge. HE grenade or mine which uses a magnet for adherence to the metal sides of tanks or ships

Ref: S. Fordham, "High Explosives and Propellants", Pergamon Press, NY, 166 (1966)

Lindeman Explosive. BritP of 1899 for an expl consisting of NG, K chlorate and MNB or DNB

Ref: Daniel (1902), 408

Lindner Explosive. FrP of 1895 for an expl contg AN 93.2, naphthalene 5.5 and K chlorate 1.3%

Ref: Daniel (1902), 409

Linear Shaped Explosive Charges. Picatinny Arsenal developed a linear shaped demolition charge (Ref 1) capable of felling trees up to 40" in diam. The charge is 7" long, 2.4" high and 4.7" wide, and contains 1.5 lbs of Comp B. It is more efficient than other shaped charges, such as conical shaped and

platter charges, because of its exceptional side-cutting ability. The claim is made that this charge uses 50-70% less expl than more conventional bulk and ring tree-cutting expl devices

Moses (Ref 3) describes linear expls consisting of tube-like containers filled with burning or detong expls of the following types:

1) *Safety fuze* used for mining and quarrying consists of BkPdr in cotton and polyethylene covers, wax dipped; 2) *Detonating cord* used for general blasting and demolition consists of PETN or RDX in a waterproof textile sheath; 3) *Mild deton fuze* is smaller than type (2); it is used to transfer detons, and has a metal sheath; 4) *Confined deton fuze* is similar to type (3) except that the metal sheath is wrapped in fibreglas and polyethylene to contain the fragments; 5) *Flexible linear shaped charge* is a detong cord with a V-shaped cross-section used to cut metal

Linear shaped charges as well as expl cords have been developed for use in commercial cutting operations. One special application is a cast iron pipe cutter called "*Jetcutter*". It makes a straight and clean cut in cast iron pipe from 6 to 12" in diameter by means of a reusable fixture and an expendable shaped charge insert. A forced entry tool, dubbed "*Jet-Axe*" cuts thru 5" of roofing material and thru fire doors and similar structures. Rapid egress systems are being developed for aircraft and other passenger carrying vehicles (Ref 3)

Refs: 1) S.J. Lowell & R.T. Schimmel, "XM184 Linear Shaped Demolition Charge for Felling Large Trees", PATR 3408 (1966) 2) J.E. Drake, Asst Product Mgr, Explosive Technology, Box KK, Fairfield, Calif 94533; Abstracted in *Expls&Pyrots* 2 (2) (1969) 3) S.A. Moses, *Ordn* 56, 355-57 (1972)

Lined Cavities of Explosives (Lined Cavity Effect). See under Detonation, Munroe-Neumann Effect (or Shaped Charge Effect) And Lined-Cavity Effect In, *Encycl* 4 (1969), D444-R to D450-R

Line Wave Generator. Devices for controlling the sequence of arrival of detonation waves at

various points in an expl charge. Those of the manifold type are made by loading expls into channels machined, molded, or cast into metal or other inert components and by constructing arrays of detong cord. These arrays are limited to relatively large systems by the spacing needed to prevent initiation or damage due to radial blast effects of adjacent cords (See Fig)

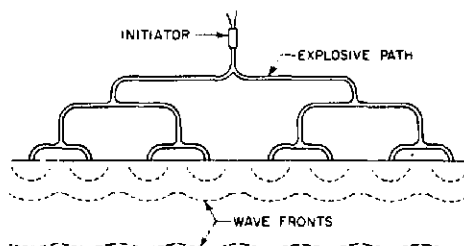

Line Wave Generator of the Manifold Type

The advent of mild detonating cord (MDC) has opened new possibilities in manifold type wave shaping devices

Another line wave generator of the manifold type consists of perforated sheet expl (See Fig)

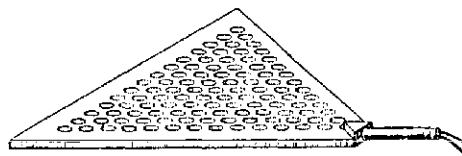

Line Wave Generator of Sheet Explosive

A duPont version (Ref 1) is in the form of perforated equilateral triangles measuring 10.9" on a side and are prep'd from "Detasheet" flexible expl. The sheet expl is perforated in such a manner that a deton initiated at any one of the apexes will proceed as a straight-line deton zone to the opposite edge

In addition to such generators, warped surfaces may be used to produce line waves of any desired curvature. The circular front generated by the point initiated deton of a plane charge may also be modified by warping the plane and by transmitting to other expl surfaces. An example, illustrated below, is the generation of a straight-line wave by means of warped sheet expl

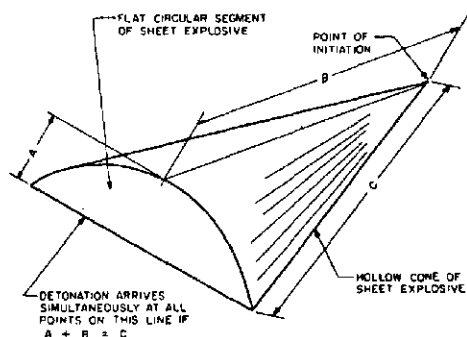

Line Wave Generator
of Warped Sheet of Explosive

Refs: 1) New Explosives Specialties Brochure on Line-Wave Generators, duPont Co, Explosives Products Div, Wilmington, Del 19898; Abstract in *Expls & Pyrots* 5 (12) (1972)
2) Anon, *Engrg Design Hdbk*, "Explosive Trains", AMCP 706-179 (Jan 1974), 3-12 to 3-13

Linen Fiber (Flax, Byssus). The bast fiber of the flax plant, an annual herb about 2 ft high. It is grown in Europe and Egypt for the fiber and in the USA, USSR & Argentina for the seeds (linseed oil). The nitrated unbleached prod was proposed by Trench (Ref 1, p 773) for use in expl compns

Nitrated Linen Fiber (Nitroflax, in Fr Nitrofen). Product resembling cotton NC and prepd by nitrating unbleached flax. When nitrated under identical conditions, flax gives a more viscous prod than cotton. In order to lower the viscosity of nitroflax, the temp of nitration is raised. Nitroflax has been used in some celluloids (Ref 1, p 120), and was proposed (Ref 1, p 773) as a basic ingredient in commercial expls, other components being collodion cotton, glycerin, ozokerite, resin, etc

Refs: 1) Daniel (1902), 120 (under Celluloid) & 773 (under Trench) 2) Hackh's (1944), 345-R

Linolein (Glyceryl linoleate). A glyceride of linoleic acid. It is one of the constituents of linseed oil which induces drying. Yel oil;

may be prepd by treating K linoleate with trichlorhydrin at 160° in a stream of H₂. V sol in eth, benz and chl_f; less sol in alc, methanol, ligroin & CS₂

The nitrated compd was proposed by Reid and Earle (Ref 2) as a constituent of expl mixts, eg, 1p nitrolinolein and 9p NC **Linolein Nitrate** (Nitrolinolein). A prod obt'd by nitration of linolein (See above) and used in some expl mixts

Refs: 1) Beil 2, 461 & (214) 2) FrP 251985 (1895) 3) Daniel (1902), 670 4) *CondChemDict* (1971), 519-L

Linseed Oil (Boiled Oil, Bung Oil or Bung Hole Oil). The oil obtained by hot pressing the seeds of the flax plant. Consists of glycerides of linolenic, linoleic, oleic, stearic, palmitic and myristic acids. Yellowish liq, peculiar odor, bland taste

"Boiled linseed oil" is a misnomer, since the oil does not boil. Small amts of driers (oxides of Mn, Pb or Co, or their naphthenates, resinates or linoleates) are added to hot linseed oil to accelerate drying. The "boiled oil" becomes thicker and darker. It is combustible, with a flash p of 403°F and an autoignition temp of 650°F (Ref 4)

For many years, boiled linseed oil has been used to coat Mg powd to protect it from corrosion when used in pyrotechnics. Mg powd and oil are mixed together and allowed to stand in a warm place in shallow trays for about 48 hours, before the other chemicals are added. Lately there has been a tendency to replace linseed oil with polyesters, or to use no coating at all, but there can be no doubt that linseed oil renders good protection. Stores made with Mg coated with linseed oil are good for several years, which is not the case with uncoated Mg (Refs 2 & 5). Linseed oil has also been used for coating K chlorate used in expls (Ref 1)

The requirements of the USA armed forces for boiled linseed oil are covered by Federal Spec TT-L-190C (Ref 3) and are as follows: (1) Set-to-touch (hours), 16 max; (2) Loss on heating at 105°±2° (% by wt), 0.3 max; (3) Acid number, 7.5 max; (4) Saponification number, 189-195; (5) Unsaponifiable matter

(% by wt), 1.50 max; (6) Iodine number (Wijs), 170 min; (7) Ash (% by wt), 0.50 max; (8) Specific gravity, 0.928 to 0.938 at 25°/25°; (9) Appearance — the oil shall be clear and transparent at 65° (149°F) when examined by transmitted light

Refs: 1) Colver (1918), 278 2) Anon, EngDesHndbk, "Properties of Materials Used in Pyrotechnic Compositions", **AMCP 706-187** (Oct 1963), 173-4 3) Federal Specification TT-L-190C, "Linseed Oil, Boiled, (For Use In Organic Coatings)" (Dec 17, 1964) 4) CondChemDict (1971), 519-R 5) R. Lancaster et al, "Fireworks, Principles and Practice", Chemical Publishing Co, NY, 42-43 (1972)

Linters. Fleecy short fibers (1/8" to 1/4" in length), consisting chiefly of cellulose, which adhere to cotton-seed after it has been passed once thru a cotton-gin. These are usually removed from the seed by a second and third ginning to yield first and second cut linters. The first cut fibers are the longer and are used mainly for padding, upholstery, mattresses, etc. Second cut linters are suitable for the prepn of various NC's after special treatment consisting of boiling in caustic soda, followed by bleaching

Purified linters are used extensively in the USA for the prepn of NC, but longer fibers are preferred in Engl. During WWI, Engl also used material called "slivers" (Ref 1, 3, p 30), which was staple cotton in the form of unspun strips — an intermediate stage in the manuf of yarn. Although more expensive than cotton waste, it yielded purer and more stable Cordite

In Fr, three kinds of cotton material were used in NC manuf: (1) Waste No 1, which consisted of bleached waste from spinning and weaving mills using long-staple cotton of Egyptian and American origin; (2) Waste No 2, consisting of unbleached spinning-mill waste and (3) Linters, similar to American linters, which must be free of cotton waste. According to deSegundo (Ref 2), some short fiber cotton called "fuzz" still remains on the seed after removing the long fibers and linters by ginning and delinting machines. In order to effect

better sepn of the linters and to have less short fibers adhering to the seed, deSegundo devised a special machine. He concluded that it is very difficult to completely remove all the fuzz without employing chemical methods

Note: See also Cotton Linters in Vol 3 of Encycl, p C547-L

Refs: 1) Marshall 1 (1917), 163; 2 (1917), 697; 3 (1932), 30 2) E.C. deSegundo, JSCI 37, 118T-123T (1918) 3) CondChemDict (1971), 520-L

Liquefaction Test. A test used to det the exudation of Dynamites. In Engl, the test was conducted as follows: A cylinder of approx equal length and diameter was cut from a cartridge of Gelatin Dynamite to be tested. With paper removed, the base of the cylinder was placed on a sheet of pasteboard and held fast by a pin driven vertically thru its center. After conditioning at 29-32° (85-90°F) for 144 hrs, the height of the cylinder was measured. If it did not shrink more than 25% of its original height, the Dynamite passed the test. Another condition of acceptability was that the upper cut surface retain its flatness and sharpness of its edges

In Germany, the test was conducted by heating an entire cartridge for 5 days at 30° (86°F). The requirement was that no NG should exude and, after cooling, that the cartridge dimensions remain unchanged

Refs: 1) Marshall 1 (1917), 163 2) Naoum, NG (1928), 314

LIQUID AIR AND LIQUID OXYGEN EXPLOSIVES

Liquid Air and Liquid Oxygen Explosives originally consisted of porous combustible materials impregnated with liquid air. Soon after liq oxygen became commercially available it began to replace liq air in these explosives. Consequently this article is devoted almost entirely to *Liquid Oxygen Explosives* commonly called **LOX**. It should be noted that **LOX** are not to be confused with *Fuel-Air Explosives* (See *FAE* in Vol 6, p F3). For **LOX** the oxidizer is liq and the fuels are either solids or liquids, while in *FAE* the oxi-

dizer is atmospheric oxygen and the fuels are usually gaseous or liquid droplets at the time of explosion. General references on liq air and liq oxygen expls are Refs 2, 3, 5, 7, 8, 14, 16, 19 & 52

In what follows we will examine:

- 1) The history of LOX
- 2) Typical LOX compositions
- 3) Uses
- 4) Detonation and sensitivity characteristics
- 5) Recent Patents

1) *History.* LOX, or more precisely *Liquid Air Explosives*, were invented by Linde in 1895, who called these expls *Oxyliquits* (Ref 1). They were made by impregnating porous combustible solids with liquid air shortly before firing the charge. Usually the combustibles, in some type of combustible cartridge, were soaked in liq air just before loading into the bore hole. Liq air expls were used extensively in 1899 in the driving of the Simplon tunnel between Italy and Switzerland

Liq nitrogen has a much lower heat of vaporization than liq oxygen, and thus evaporates more readily. Because of this, liq air (a mixt of nitrogen and oxygen) becomes progressively richer in oxygen as it is warmed or even in storage. This makes it almost impossible to control the oxygen content of a liq air expl charge, even if it is fired promptly after preparation. Variable oxygen content can result in poor performance, or even non-performance, and in uncontrolled explosive fumes. Thus, the natural tendency to replace liq air with liq oxygen in these expls began as soon as liq oxygen became commercially available. This occurred some years prior to WWI

During WWI the Germans used LOX (and also liq air explosives) extensively in coal, iron and potassium mines, in tunneling and in demolition work. In 1922 LOX were used in Mexican silver mining and a few years later they were introduced into the copper mines of Peru and Chile

In the USA, LOX have been used primarily in the strip mining of coal. For example, in 1950, 99.5% of all the LOX used was in coal mining (Ref 18). Most of this must have been for moving overburden, since LOX are *non-permissible* (not allowed by law in gassy mines),

and their fume characteristics make them unsuitable in many underground mines even if they are non-gassy. The following tabulation (from Ref 18) shows that LOX consumption in the 1950's amounted to some two to three percent of the total expls used

Table I
SALES (Millions of Pounds) OF INDUSTRIAL EXPLOSIVES*

Year	Black Blasting Powder	Permissibles	Other than Permissibles	LOX
Average				
1935-1939	65.4	45.7	253.6	Not available
1949	20.1	91.6	505.6	13.9
1950	20.7	109.4	576.0	13.8
1951	14.0	108.3	611.2	20.3
1952	10.6	95.5	636.7	21.9
1953	9.5	89.9	669.0	22.5
1954	10.3	75.9	615.8	17.7
1955	6.6	93.7	687.2	19.3
1956	5.6	97.7	(814.4)	Not available

*Data kindly supplied by Robert W. Van Dolah, Chief, Division of Explosives Technology, Bureau of Mines, Pittsburgh, Pa

Since then the use of LOX has declined greatly, as ANFO and Slurry Explosives began to replace them. An indication of the decline in the use of LOX is given in the patent literature. For example, a 1936 review (Ref 8) lists 64 German patents on LOX. Undoubtedly by 1936 there were also many patents issued in the USA, UK and France. In the period of 1936-1960 a considerable number of patents on LOX is listed in CA. Some of these are abstracted in Section 5 below. Since 1960, however, the number of LOX patents has declined drastically. Almost none is listed in the most recent Quintennial Index of CA

2) *Typical LOX Compositions*

Both Liq Air and Liq Oxygen expls contain porous combustible material as fuel. These fuels are generally contained in paper or cloth cartridges. Occasionally liq fuels such as petroleum are mixed with the porous solids; eg, some of Linde's early compositions (Ref 1) contained kieselguhr mixed with petroleum. Carbonized cork was also used in early Liq Air Expls, although charcoal was the original absorbent. More recently, as liq air was replaced

Table 2

LOX Compositions and Properties

Initial Composition (a) (parts)	Initial Sp Gr, g/cc	Relative Strength (b)	Detonation Rate (m/sec)
38/225 LampBlack/LO	0.23 (c)	0.95	4200
57/230 LampBlack/LO	0.33 (c)	1.14	5000
65/225 Gas Black/LO	0.33 (c)	1.16	5000
49/12/215 Gas Black/FeSi/LO	—	0.94	—
36/28/193 Woodpulp/Kieselguhr/LO	1.07	0.92	4180
49/12/216 Woodpulp/Lampblack/LO	0.76	0.80	3350
58/7.3/167 Woodpulp/Kerosene/LO	0.93	0.95	4660
64/26/182 Woodpulp/Kerosene/LO	1.09	0.80	4080
33/49/218 Fuel Oil/MgCO ₃ /LO	—	0.99	4000
47/210 Carbene /LO (d)	0.24 (c)	1.13	5200
			6430 (e)

(a) Before any appreciable evaporation of liq oxygen (LO)

(b) Relative to 40% Dynamite on a volume basis

(c) "Unsoaked" fuel; "soaked" sp gr not given

(d) Carbene is polymerized acetylene

(e) In an iron tube; presumably all other detonation rates are for unconfined cartridges

by liq oxygen, lampblack became the absorbent most commonly used in LOX (Ref 12). The fuel content of LOX compositions should be capable of absorbing 5 to 6 times their weight of liq oxygen

Many other fuels such as soot, turf, corkmeal, powdered anthracite, woodmeal, carbene (polymerized acetylene), calcium hydride, and spongy aluminum have been tried. Physical and chemical properties of many LOX fuels are given by Howell et al (Ref 3) and O'Neil & Van Fleet (Ref 5a)

Several of the potentially useful LOX compositions with some of their physical and detonation characteristics are listed in Table 2 (taken from Ref 6). Some recent LOX compositions are given in Section 5

3) *Uses.* In section 1, we showed that most of the LOX in the USA are used in the strip mining of coal. In Europe LOX were also extensively used in open pit mining, tunneling and construction. Indeed, in the first half of this century, LOX were used in most expls applications, although not extensively, where fumes were not a problem. O'Neil & Van Fleet (Ref 5a) consider LOX economical and safe (See Sect 4 on LOX safety). La Magna (Ref 9) prefers LOX to Dynamites. In the last decade

LOX have been almost entirely replaced by ANFO or Slurry Explosives

In actual practice LOX were always prepared near the explosion site. Usually a paper cartridge containing the absorbent fuel was "soaked" in liq oxygen. The soaked cartridges were quickly placed in the borehole and fired promptly. Extensive tests (Ref 3) showed that firing had to occur within 5 to 15 minutes after soaking, otherwise enough liq oxygen evapd to affect LOX performance or even cause misfires. The LOX charges were generally fired with blasting caps. Under favorable conditions, LOX charges can be initiated by flame, but this type of initiation is uncertain, and the performance of LOX thus initiated tends to decrease. As discussed in Section 4, the sensitivity of LOX to flame can be a safety hazard

In some operations, a cartridge packed with absorbent fuel was inserted in the borehole and filled with liq oxygen thru a tube reaching to the bottom of the cartridge. A vent for evapg oxygen had to be provided

Yet another method was to make cartridges with two compartments, one for absorbent and the other for liq oxygen. After insertion in the borehole, the partition was ruptured (either by pressure from the oxygen or by mechanical

means from outside) to mix the liq oxygen with absorbent. To increase the allowable time between liq oxygen impregnation and firing (from 10 minutes to 16–22 minutes), Wakabayshi (Ref 21) suggests precooling the borehole by pouring small amounts of liq oxygen into it.

4) *Detonation and Sensitivity Characteristics*

a) *Detonation Characteristics.* LOX are commercial explosives and as such are used primarily in breaking and moving rock and overburden. From a practical point of view, it is important to have a measure of the effectiveness of LOX blast in fracturing and moving the "burden". No single universally accepted measure of blast effectiveness exists today, and certainly none existed in the 1920–1940 period when most of the exptl studies of LOX were carried out. Practical experience suggests that the effectiveness of an explosive for fracturing "burden" is related to its brisance. Brisance is a measure of the shattering power of an explosive and is closely related to the detonation press (commonly called P_{CJ} or Chapman-Jouguet pressure) of the explosive (See Brisance in Vol 2, p B265–300). The effectiveness of an explosive for moving "burden" is related to its strength or power (See Vol 4, p D730-L).

It is customary to rate explosive strength on a relative basis, ie, as a percentage of the strength of some standard explosive – usually TNT or some standard Dynamite. This rating is based on comparison tests, the most common of which is the Ballistic Mortar Test (See Vol 2, p B6-R).

Unlike the relation between brisance and P_{CJ} , expl strength is not readily related to some detonation characteristic of the explosive. Attempts to relate strength to detonation energy are not wholly successful. Relative strength, based on ballistic mortar tests, correlates rather well with computed nRT , where n & T are the computed moles of gas and detonation temp of the explosive, and R is the gas constant. Although n & T can differ appreciably with the equation of state used in the computation, it appears that ratios of nRT (at least for similar explosives) do not suffer from this drawback.

In the early expls literature (and much of the LOX work is in the "early" literature) there is a great deal of confusion between brisance and strength.

Now, with the above caveat, we can examine

what is known of LOX detonation characteristics

Perrott (Ref 4) examined the effect of packing density on the relative strength of six liq oxygen-lamp black compns, and measured their detonation rates, D . Relative strengths on a weight basis increased as packing density increased except that the relative strength at the highest packing density tested (0.46g/cc "unsoaked") was low. On a volume basis the compn at the lowest packing density (0.19g/cc "unsoaked") had the highest relative strength. Detonation rate increased from 4500 to 6000m/sec, although it is not clear whether this increase, as expected, occurred as packing density was increased. Perrott also found that substituting Al for some of the absorbent did not increase D but made the compn easier to detonate.

In a subsequent study (Ref 5) Perrott found that 1¼ inch diameter cartridges of LOX, containing lamp black, gave optimum blast results at an "unsoaked" packing density of 0.30g/cc. This takes into account not only the strength of the LOX but also their effective "life", ie, the maximum allowable time between "soaking" and firing. For example, 5 minutes after soaking, LOX cartridges were found to have a relative strength (on a volume basis) 115% that of a standard Dynamite, but after 25 minutes their strength was only 65% of the Dynamite. Perrott suggests using as large a cartridge diameter as practicable to reduce oxygen evapn. He also made further measurements of detonation rate and found that it is controlled by the finest particle size component of the absorbent. Clark & La Motta (Ref 7) also found that D increases as absorbent particle size decreases. For gas-black LOX, D varied from 4000 to 6200m/sec, while for lamp black LOX D varied from 4200 to 5000 m/sec. Perrott states that LOX will burn without detonation when unconfined but will detonate erratically when ignited under confinement.

Okada (Ref 15) states that the oxygen to carbon ratio for LOX of maximum brisance is 2.6. This is essentially the theoretical ratio to convert all the carbon to CO_2 . This writer believes that Okada really meant maximum strength rather than maximum brisance, as the latter depends not only on compn but also on pack-

ing density

Okada's conclusions are supported by Streng & Kirshenbaum (Ref 20) who found that a stoichiometric mixture (33 mole% CH₄) of liq methane and liq oxygen had a higher brisance (in this case they really measured brisance) and a higher detonation rate than other mixts containing from 6 to 80 mole % CH₄. They also determined the expl limits and detonation rates of these mixts and examined the sensitivity of the stoichiometric mixt to impact, shock waves, and flame & sparks. Their results are summarized below:

Mole % CH ₄	Density	Detonation Rate
6	1.05	Failed
20	0.98	3325
33	0.88	5110, 5130
40	0.83	5110
50	0.76	4620, 4610
67	0.65	Detonated
80	0.50	Failed

Although the above are not practical LOX compositions, these results are of considerable interest. They show that the detonation limits of LOX compns are quite wide, and that D (at least for liquid methane-liquid oxygen mixtures) is not strongly affected by considerable changes in compn or even density

Cook (Ref 22) studied a chemically similar mixt consisting of 78/22 LOX/kerosene (stoichiometric to CO₂ & H₂O), but the kerosene, ie, the fuel, in his case was frozen, so that he dealt with a slurry rather than a solution. His results are as follows:

Density	D	P _{CJ}
1.04g/cc	2240m/sec	10.4kbar

Note that D for the slurry is much lower than for the liq CH₄-liq oxygen solns even though the apparent slurry density is higher than those in Table 3. Possibly this is due to incomplete reaction, even though Cook emphasizes that he used mechanical stirring. Cook's D is also very low compared to the D's in Table 2, for practical LOX compns containing solid absorbent fuels

Cook (Ref 18a) presents theoretical calculations of the detonation parameters of several carbon black-liq oxygen compns. He gives

no comparisons with experimental results.

In this writer's opinion, Cook's values (Table 12.20 of Ref 18a) of T_{CJ} are too high and his P_{CJ} are too low; the products probably contain more free carbon than shown. However, there is little doubt that most LOX detonations are "hot", ie, they will readily ignite firedamp (Refs 2, 3, 12 & 14). Also the computed detonation velocities (estimated from Cook's P_{CJ}) show a much greater variation with compn and density than the experimental data of Table 3

b) *Sensitivity Characteristics.* Early investigators (Refs 5a & 9) tended to overestimate the safety of LOX because they were non-explosive before mixing, and because they became non-explosive, even after a misfire, as the oxygen evapd. An interesting comment, by Wakabayashi (Ref 21), significant in these days of terrorist bombings, is that LOX are burglar-proof. Nevertheless, modern consensus is that LOX are more dangerous to handle than conventional Dynamites (Refs 7, 12, 14, 17 & 21)

One of the most serious faults of liq oxygen explosives is the ease with which they inflame and the rapidity with which they burn, amounting practically, in the majority of cases, to their exploding from fire. Denues (Refs 10 & 11) has found that treatment of the granular carbonaceous absorbent with an aqueous solution of phosphoric acid results in an explosive which is nonflammable by cigarettes, matches, and other igniting agents. Mono- and diammonium phosphate, ammonium chloride, and phosphoric acid were found to be suitable for fireproofing the canvas wrappers. Liq oxygen expls made up from the fireproofed absorbent are still capable of being detonated by a blasting cap. Their strength, velocity of detonation, and length of life after impregnation are slightly, but not significantly, less than those of expls made from ordinary non-fireproofed absorbents containing the same amount of moisture

Streng & Kirshenbaum (Ref 20) found that a stoichiometric mixture of liq methane and liq oxygen will explode from the flame of a safety fuse

Some LOX compns are liable to self ignite (Ref 12). Cook (Ref 18a) makes the interesting suggestion that many LOX compns do not

self-ignite only because they are so cold

Clark & La Motta (Ref 7) showed that LOX made with gas black or lamp black are more sensitive to impact than the standard Bureau of Mines 40% straight Dynamite. Impact sensitivity increased when small amounts of iron oxides, aluminum dust or ferro-silicon were added to the LOX. Impact sensitivity also increased as absorbent particle size was reduced. As the oxygen evapd, impact sensitivity, as expected, decreased

In tests of materials saturated with liq oxygen and subjected to 71–75 lb drop weight tests, the following were found acceptable (one detonation/40 impacts or none/20): fluorocarbon oils & greases, graphite, halogenated biphenyl & molybdenum disulfide lubricants, polyethylene & pure poly fluorocarbons. The following explode: synthetic elastomers & Thiokols, cellulose-based papers, silicone-based oils & greases, thermoplastics (except pure Teflon), thermosetting plastics, petroleum-based oils and greases (Ref 17)

LOX are sensitive to sympathetic detonation, ie, detonation initiated by a nearby charge separated from the LOX by an air gap (Refs 7 & 20)

The pseudo-LOX of liq methane–liq oxygen are exploded by bullet impact (Ref 20)

LOX compositions are sensitive to friction (Refs 12 & 14) and to static discharge. Assonov (Ref 13) attributes the premature explosions of liq oxygen on adsorbents (fuels) to small dust particles. As the charge is dropped into the borehole, the small particles become detached from the adsorbent. These particles are carried upward by the oxygen vapors and become electrostatically charged by friction.

Potentials of the order of 15000–20000 volts were measured on these particles. A discharge of such potentials suffices to initiate the LOX. Dust can be minimized by moistening the adsorbent with 20–25% of water or by providing special capsules for the expl. Good results were obtained by using briquetted fibrous vegetable matter, peat, straw, wood pulp and the like as adsorbents. Such briquets did not produce dust when dropped from a height of 25m. The brisance of the LOX made of such briquets was only ~ 3 –4% less than that of ordinary LOX

Streng & Kirshenbaum (Ref 20) exploded stoichiometric liq methane–liq oxygen by the discharge of a 0.1 microfarad condenser, charged to 1500V, across 1–3mm air gaps

5) *List of Recent Patents on LOX*

Review of liq air blasting explosives since 1920: a tabulation of 64 German patents with brief abstracts. J. Mayer, SS 31, 405–07 (1936) & CA 31, 1211 (1937)

Liq oxygen is used with an intimate mixture of a main mass of a solid combustible material such as lamp black together with starch in a proportion materially to reduce the sensitivity of the explosive (eg, 10–30% of 300 mesh starch). H. Sauvage, USP 2076279 (1937) & CA 32, 3697 (1937)

Granular carbonaceous material such as “Bugbird carbon” is impregnated with a solution of a fire-proofing material such as Amm phosphate or Ca chloride and the treated material is used as a carrier for liq oxygen. G.B. Holderer, USP 2119050 (1938) & CA 32, 5630 (1938)

A carbonaceous absorbent is used together with at least $\sim 5\%$ of phosphoric acid and at least $\sim 2\%$ water, based on the weight of the dry carbonaceous material, serving to avoid undue flammability. A.R.T. Denues, USP 2297538 (1943) & CA 37, 1606 (1943)

The prepn of a liq oxygen explosive, especially useful in mining operations, is described. It is safe to handle and is characterized by high brisance and power. Activated or adsorbent C (150–250 mesh), free of hydrophobic and of low-temperature volatile materials or impurities having low ignition points, is treated with phosphoric acid or a salt of phosphoric acid in a weight ratio of 2.5 to 18% of C, and sufficient water to form a slurry. The slurry is dried with agitation at 250–450°F, and the resulting product is then placed in fireproofed canvas bags and dipped in liq oxygen. The amount of oxygen taken up by each part of the treated C is ~ 1.8 parts. This product can be ignited but not detonated by burning paper, and is not affected by rifle fire of 0.30 caliber soft nose bullets. It can be detonated with a Primacord detonator. L.P. Barlow, USP 2723188 (1955) & CA 50, 4510 (1956)

H. Sauvage, BritP 791930 (1958) & CA 52,

17716 (1958) claims preparation of combustible material (starch) for LOX in the form of compressed pellets using a press of at least 15kg/cm². The disruptive power of these expls compares very well with permanent expls

F.L. Shea, Jr., USP 2872305 (1959) & CA 53, 7597 (1959) claims preparation of LOX by grinding a suitable bituminous material to a preferred particle size of 65–95% thru 200 mesh, and flash-calcining at >1150°F, preferably 1350–1650°F, with an oxidizing gas containing sufficient oxygen to oxidize all but about 10% of the volatile matter in the feed, which volatile matter should be ~15–20% of the feed. The product thus obtained is then immersed in liq oxygen to form the expl

H. Sauvage, FrP 1112288 (1956) & CA 53, 8630 (1959) claims preparation of LOX for open-air shooting by the same processes as usual, but adjusting the sacking of the carbon black in such a way that CO is formed in the explosion. The brisance of these expls is claimed to be about 50% higher than that of PA

J.P. Perdrizet, FrP 1114985 (1956) & CA 53, 15570 (1959) describes LOX which are insensitive to shock and have a prolonged life. They contain as a fuel a dry starch paste obtained from potatoes or manioc, which is free of fatty matter and has a grain size between 12 and 64 mesh/cm. In cartridges containing this type of filling and used in the vertical position, the very finely pulverized starch is divided into several compartments by horizontal and vertical divisions of impregnated paper or tissue, impermeable to liq oxygen, to diminish the height of the liq oxygen and thereby its flowing out. The filling is compressed in a higher or lower degree to give cakes of variable density, preferably having an apparent density of 0.45–0.65g/cc

S.W. Martin, USP 2812246 (1957) & CA 52, 3346 (1958) claims prepn of impact-resistant LOX from an adsorbent carbon obtained by flash-oxidation-calcination of a finely divided swelling bituminous coal (with a volatile content of >12%) in a stream of oxygen-contg gas at 800° or more. An expl prepd from this carbon was insensitive to impacts of >1200ft-lb. It failed to detonate when burned in semi-confinement with a 0.25 inch

orifice. Its vel of deton was 14050ft/sec

J.P. Perdrizet, FrP 1132039 (1957) & CA 53, 18487 (1959) claims highly brisant, small-diameter, low-cost, shock-resistant LOX cartridges are made with fuels obtained from pulp residue from the extraction of starch from potatoes, and sugar from beets

F.W. Brown, USP 2879149 (1959) & CA 53, 11840 (1959) claims prepn of a low-cost expl having high brisance and gas-forming ability but much lower fire and detonation sensitivity than conventional liq oxygen-carbon black expls by mixing 10–80% (preferably 20%) lampblack or carbon black with 90–20% AN and then saturating with liq oxygen. Such an expl has a rate of deton of 6000m/sec. Resistance to fire is substantially increased by incorporation of up to ~10% water based on the solids

Andrew Hyslop, Jr, USP 2886424 (1959) & CA 53, 15570 (1959) describes processes for making mixts of liq oxygen and finely divided fibrous or spherical hydrocarbons (I) for use as expls. These mixts are less hazardous than similar prior-art mixts. The mixing chamber is cylindrical, open at the top, with a funnel-shaped bottom. Thru two nozzles, jets of atomized oxygen are made to intersect near the middle of the chamber. A downward directed spray of atomized liq (I) is congealed as spheres or strands on mixing with the oxygen. The mixt of oxygen and congealed (I) is collected in a container below the congelation chamber. Hydraulic, diesel, lubricating oils, kerosene and gasoline may be used. The particles of (I) are preferably <0.01 inch in diameter. Liq nitrogen may be used to make the divided (I) for later mixing with liq oxygen. Water but not carbon tetrachloride, may be atomized into the chamber with 4 parts oil to produce less-sensitive expls

C. McKinley, USP 2939778 (1960) & CA 54, 17888 (1960) claims prepn of a liq expl which is relatively safe to prepare, store and use under controlled conditions, by dissolving in liq oxygen a fuel, preferably methane or its admixture with small amounts of heavier, normally gaseous hydrocarbons; natural gas is an excellent fuel. Stoichiometric proportions are used for maximum disruptive effect

Written by J. ROTH

Refs: 1) G. Linde, Ber **32**, 925 (1899)
 2) G.S. Rice, USBureauMinesTechPaper **243** (1920) 3) S.P. Howell et al, USBurMines TechPaper **294** (1923) 4) G.St.J. Perrott, Eng&MinJ **117**, 610 (1924) & CA **18**, 1909 (1924) 5) G.St.J. Perrott, TransAmInst-MiningMetEng (preprint) (1925) & CA **19**, 3020 (1925) 5a) F.W. O'Neil & H. Van Fleet, TransAmInstMiningMetEng **1562A** (1926) & CA **20**, 1524 (1926) 6) Marshall **3** (1932), 157 7) L.V. Clark & A. La Motta, USBurMines RJ **3169** (1932) & CA **26**, 3669 (1932) 8) J. Mayer, SS **31**, 405 (1936) & CA **31**, 1211 (1937) 9) L. La Magna, Industria (Milan) **53**, 315 (1939) & CA **36**, 6347 (1942) 10) A.R.T. Denues, AmInst-MiningMetEng, TechPubl **1199** (1940) & CA **34**, 5661 (1940) 11) A.R.T. Denues, USBurMinesBull **429** (1940) & CA **34**, 8281 (1940) 12) Davis (1943), 355-57
 13) V.A. Assonov, Kislород **1944** No 3, 28 & CA **40**, 3605 (1946) 14) W.E. Tournay et al, USBurMines Bull No **472** (1949) & CA **44**, 4679 (1950) 15) J. Okada, JSocHigh-PressGasInd **18**, 97 (1954) & CA **49**, 16436 (1955) 16) L.N. Marchenko, "Oksilikvity no Otkrytykh Gornykh Rabotakh" (Oxyl-iquits in Open-pit Mining), Ugletekhizdat, Moskva (1955) 17) A.J. Zachringer, Mis-siles&Rockets **4**, 14 (1958) & CA **52**, 21109 (1958) 18) Cook (1958), 5 18a) Ibid, 314-15 19) A.D. Yakhontov et al, "Oksklik-ivity, Ikh Proizvodstvo i Primeneniye" (Oxy-liquits, their Manufacture and Uses), GosNauk-TekhIzdat, Moskva (1958) 20) A.G. Streng & A.D. Kirshenbaum, JChemEngData **4**, 127 (1959) & CA **54**, 897 (1960) 21) T. Waka-bayashi, KoatsuGasu **4** (2), 87 (1967) & CA **69**, 68687 (1968) 22) M.A. Cook, "The Science of Industrial Explosives", Graphic Service & Supply, IRECO Chemicals, Salt Lake City, Utah (1974), 170-77

Liquid DNT. See Drip Oil in Encycl **5** (1972), D1546-L to D1547-L

LIQUID EXPLOSIVES

A liquid explosive, as the term implies, is an expl substance that is liq at ambient temp. Liquid Explosives (**LE**) can be pure compounds or mixts of miscible compounds, including aqueous solutions. Expls containing a mixt of liq and solid phases, eg, the so-called Slurry Explosives, as well as Liquid Oxygen Explosives (**LOX**), are described in separate articles

In the present article we will review the history, uses and characteristics of LE under the following headings:

- 1) History
- 2) Typical LE
- 3) Specialized Uses of LE
- 4) Detonation Phenomena in LE
- 5) Initiation Phenomena in LE
- 6) Brief Abstracts of Recent Publications on LE which were not specifically drawn upon in the discussion of the items above. Greater detail on specific LE will be found in Encycl articles on the individual explosive, eg, under Ethylene Glycol Dinitrate (**EGDN**) (Vol **6**, pp E259ff), Glycerol Trinitrate (**NG**) (Vol **6**, pp G98ff), etc

1) *History.* The first LE of practical importance was NG. It was discovered by an Italian chemist, Ascanio Sobrero, in 1846. The "taming" of NG by Alfred Nobel is described in the article on Dynamite in Vol **5**, p D1586-R. Even today NG and its close chemical relative EGDN are the best known sensitizers for conventional Dynamites. In recent years, however, Slurry Explosives, whose liq phase is primarily aqueous Ammonium Nitrate (**AN**), and which contain no NG or EGDN, have been steadily replacing Dynamites (Ref 32)

Late in the nineteenth century, Herman Sprengel patented a series of simple oxidation-reduction mixts for use in commercial blasting. These so-called Sprengel explosives typically consisted of concd nitric acid, or liquid NO_2 , mixed with liq fuels such as nitrobenzene, carbon disulfide, petroleum, etc. They were intended to be mixed immediately before use. Because of handling difficulties Sprengel expls never became very popular (Refs 4 & 6)

Mixts of liquid NO_2 with liquid fuels are also known as Panclastites. They are very sen-

sitive to shock and must be handled most carefully after mixing (Ref 4). In the 1950's liquid N_2O_4 /kerosene mixts were briefly used in strip mine blasting of overburden. Handling difficulties again led to the abandonment of these expls

Use of LE in minefield clearance during WWII is described in section 3

In recent years liq Nitromethane, NM, although rarely used as a practical expl, has been studied from the point of view of initiation and detonation theory probably more than any other expl, liq, solid or gas. Some of these studies are discussed in sections 4 & 5

2) *Typical Liquid Explosives.* Probably the most important class of LE are the liq nitrate esters. The most important members of this family are NG (See Vol 6, p G98-R), EGDN (See Vol 6, p E259-R) & DEGDN (See Vol 5, p D1232-L). The mono esters, $MeONO_2$ and $EtONO_2$ (See Vol 6, p E143-R), are also expl but are relatively unimportant in both expl practice and theory

Another class of LE are the Nitromethanes. As already mentioned, NM is probably the most thoroughly studied expl. Tetranitromethane, TNM, is expl by itself, and forms very powerful and very sensitive mixts with liq fuels (See below)

In recent years, many Fluoro derivatives have been studied as potential high energy constituents of proplnts. Many of these compounds are liquids and some are highly explosive. The Bis(2-Fluoro-2,2-Dinitroethyl) Formal, FEFO has been studied by the military and the AEC (Ref 30). Some theoretical studies of Bis-Difluoramino Alkanes have been reported (Refs 26 & 26e)

LE mixts abound although few are used in practical applications. Some of these are listed below:

Acenina is an equimolar mixture of $HNO_3/H_2O/CH_3CN$. It was used in a theoretical study by Davis et al (Ref 14)

Anilites are mixts of liq N_2O_4 and benzene. They are not used at present (See Vol 1, p A443-R)

Dithekite is 63/24/14 HNO_3 /Nitrobenzene/ H_2O . Cook used it in his investigation of "detonation plasma" (Refs 6, pp 190-94 & Ref 7)

LX-01, also called NTN, an all-purpose AEC LE, consists of 51.7/33.2/15.1 NM/TNM/1-Nitropropane (Ref 30, pp 18-25)

MEN-II, also called RX-01-AC, consists of 72.2/23.4/4.4 NM/MeOH/Ethylenediamine (Ref 30, pp 3-4): A similar mixt was used in WWII for minefield clearance (Ref 5)

Monomethylamine Nitrate solutions containing 10 to 15% water are used as sensitizers in Slurry Explosives. Very recently a tank car filled with such a soln blew up in a railway yard in Wenatchee, Washington

N_2O_4 /fuel, usually in stoichiometric proportions, has been used in commercial blasting and in **Anilites** (Ref 2 & Vol 1, p A443-R)

PLX, a 95/5 mixt of NM and ethylenediamine, was used in clearing minefields (Ref 27)

TNM/fuel mixtures, such as stoichiometric mixts of TNM and hexane, benzene or nitrobenzene, have been used in specialized applications. They are extremely sensitive since several accidents have been reported (Ref 3). This great sensitivity may be associated with their very small critical diameter (See Vol 4, p D653-L). For example, the critical diameter of 87.5/12.5 TNM/NBz is <0.1 mm as compared to ~ 1 mm for NG (Ref 8a)

3) *Specialized Uses of Liquid Explosives.*

Liq NG, EGDN, or their mixts are sensitizers par excellence for Ammonium Nitrate, which is the main expl ingredient of modern Dynamites. Why they are so effective is still somewhat of a mystery. Possibly it is because both these liquids, and their mixts, are easy to initiate, and because, once initiated, they will propagate in small (1mm diameter) columns

Both NG and EGDN are gelled by Nitrocellulose (NC) and form the matrix of water-resistant Gelatin Dynamites. The NG-NC gels are also the main constituents of double-base smokeless powders and of triple-base powders (which also contain Nitroguanidine). Nitroglycerin is also a constituent of many modern high-energy composite propellants

The use of a concd aqueous soln of Monomethylamine Nitrate as a sensitizer for Slurry Explosives was mentioned in the preceding section

The above constitute the main uses of LE, amounting to millions of pounds yearly. However, none of these uses is for the LE by itself, ie, solely as a liq. Neat NG has been used in "shooting" oil wells during the secondary recovery of oil. When oil production from a primary well began to lag, four secondary holes were drilled around the primary well so that all the holes, primary and secondary, were in the form of a "five spot". The secondary holes were then loaded with neat NG and shot. Water was then pumped into the secondary holes which forced oil into the primary hole by displacement. It was claimed that neat NG produced better rock fracturing and fissuring than Dynamites, and thus facilitated oil displacement by the water that penetrated into the cracked strata (Ref 1)

LE may be used for cutting breaks in a forest fire. This is done by stretching plastic tubing along the path where the break is desired, filling it with LE and detonating it. A path free of underbrush and foliage is thus cleared with very little danger of ignition of flammables along the path (Refs 21 & 23)

Minefield clearance by LE was studied during WWII. A system developed in these studies consisted of a number of rubber hoses, placed in parallel on a suspected minefield. They were then loaded with a liquid mixture of NM and ethylenediamine and detonated. A variation of this scheme was to gel the above mixt (Santocel ARD proved to be a usable gelling agent), spread the gel over the suspected minefield and detonate it (Refs 5, 5a, 5b & 5c)

Conversely, a recent development is claimed to have produced a "liquid" land mine. Liquid Astrolite, a proprietary expl compn of the Explosive Corp of America, Issaquah, Washington (See Sect 6), is spread over the ground where it remains "active" for up to 4 days. This "landmine" is not detectable by standard mine detectors. It is fired by a standard blasting cap (Refs 24 & 25)

An interesting use of LE (usually NM) is in the Explosive Gas Gun (See Vol 6, p E419-R)

4) *Detonation Phenomena in Liquid Explosives.* Detonation parameters of LE are similar to those of solid expls of comparable density and energy content. This is shown in Table 1 which is to be compared with Table 3-5 of Ref 29

Nevertheless, LE detonations exhibit certain phenomena not usually found in comparable solid expls. Many of the unique characteristics of LE detonations are ascribable to their homogeneity, whereas most solid expls are heterogeneous. These effects, peculiar to LE, will now be described in some detail

A) *Similarities in Detonation in Liquid and Gaseous Explosives*

Above we have stressed that detonation parameters of LE and solid explosives are comparable. Nevertheless, LE often exhibit detonation phenomena that resemble gaseous detonations more than detonations of solid expls. A simplistic view, but one that has some merit, rationalizes the "dual" nature of LE as follows: the resemblance to solid expls is due to the similar densities of most LE and solid explosives; the similarities with gaseous expls are due to the homogeneity of LE and gaseous expls (solid expls except for perfect single crystals are heterogeneous)

An excellent review (with 27 references) of the similarities of LE and gaseous expls is given by Dremine & Rozanov (Ref 17a). They point out the following main similarities:

- a) Detonation velocity changes insignificantly with charge diameter until a critical diameter is reached below which propagation of detonation ceases abruptly
- b) The critical diameter depends strongly on the energy content of the expl. Thus dilution of the expl with inert additives lowers the critical diameter sharply
- c) The detonation is attenuated upon passage from a narrow container into a large volume, eg, in passing from a cylinder into an expanding cone

Dremine & Rozanov suggest that these similarities can be rationalized on the basis of a similar reaction mechanism for both LE and

Table 1
Experimental Detonation Properties of Some Liquid Explosives (a)

LE	Density g/cc	Detonation Velocity D (m/sec)	Chapman-Jouguet Pressure P_{CJ} (kb)	Heat of Detonation ΔH_{det} (b) Kcal/g	Chapman-Jouguet Temperature of Detonation T_{CJ} (°K)
LX-01 (c)	1.24	6840 (30, pp 18–25)	156 (30, pp 18–25)	—	—
NG	1.60	7700 (30, pp 18–45)	253 (30, pp 18–45)	1.48 (d)	4000 (9) 3500 (10)
NM	1.16	6370 (14)	141 (10)	1.23 (30, pp 18–47)	3700 (9) 3380 (13) 3380 (12)
55.5/44.5 NM/TNM	1.31	6880 (12)	156 (12)	—	3750 (12) 4650 (g) (10)
TNM	1.64	6360 (12)	159 (12)	—	2800 (12) 3100 (9)
TNT (liq)	1.45 (e)	6590 (e) (14)	182 (e) (14)	1.11 (f) (30, pp 18–81)	3030 (12)

(a) Bracketted numbers are Refs

(b) Highly confined samples in a calorimeter; H₂O (liq)

(c) 51.7/33.2/15.1 NM/TNM/1-Nitropropane

(d) Computed; should be reliable for this nearly oxygen-balanced explosive

(e) At 93°C

(f) For solid TNT with 0.02 kcal/g correction for heat of fusion

(g) For a 50/50 NM/TNM mixture

gaseous expls. We will examine this suggestion in a later section

B) Experimental Detonation Temperatures

The last column of Table 1 lists some experimental detonation temperatures (T_{CJ}) obtained by optical methods. Although there is considerable disagreement between measurements made by different investigators, these T_{CJ} values are probably the best that are now available. Detonation temperature is a very important parameter in detonation theory, inasmuch as it provides: 1) the best test for the validity of an equation of state of the detonation products (See Vol 4, pp D268–298) and 2) insight into the chemical reaction rates in the detonation process

Most of the many equations of state (See Vol 4, pp D268ff) proposed for detonation products are capable of providing computed detonation velocities, D, in good accord with

experiment. Indeed, many authors use measured D's as a normalization parameter or adjustment factor for their equation of state. Agreement between computed and measured detonation pressure is a better test of the validity of an equation of state, but this test is still far less sensitive than that provided by agreement between computed and measured T_{CJ}

Usually detonation temps are high enough to make reaction rates (extrapolated from data obtained at much lower temps) at T_{CJ} very fast — possibly so fast as to be no longer rate controlling (See *Kinetics* in this Vol). Thus, from the point of view of chemical kinetics, temps in the pre-detonation shock are of greater significance than T_{CJ} (See Sect 5)

There are conceptual difficulties in the optional methods of measuring T_{CJ} for LE. However, these difficulties are much less severe than for solid heterogeneous expls for which

"Detonation Light" may have little relationship to the detonation process (Ref 16). The main problems in T_{CJ} measurements for LE arise from the fact that: 1) the detonation zone is "screened" by a highly absorbent shock zone ahead of it; 2) the radiation received by the detector comes primarily from the foremost front layers of the detonation zone and may not necessarily correspond to T_{CJ} which is an equilibrium temp and 3) the radiation may not be blackbody or graybody. Nevertheless, these "detonation temperatures" for LE are the best we have at present. Incidentally, the values listed in Table 1 appear to agree better with the BKW equation of state (Ref 12) than with some other equations of state

C) *Low Velocity Detonation (LVD)*. LVD is a phenomenon commonly encountered with LE. LVD is a reaction wave phenomenon that propagates in LE at a constant velocity just slightly greater than the speed of sound in the unreacted liquid. Thus a typical LVD propagates at around 2000m/sec whereas a C-J or High Velocity Detonation (HVD) in LE propagates at 6000 to 8000m/sec (See Table 1). Both LVD and HVD can occur with the same LE depending on confinement, charge diameter and conditions of initiation. LVD can turn into HVD but not conversely. A stable LVD requires that the speed of sound in the container wall exceeds the LVD velocity

The commonly accepted model for LVD is the so-called cavitation model. It is believed that precursor shocks, propagating thru the charge container, produce cavitation zones in the liq ahead of the LVD. The vapor bubbles (cavities) then act as sites for ignition and growth of chemical reaction to support the LVD wave (Ref 15)

Chaiken (Ref 28) has shown that the cavitation model is consistent with the classical C-J picture of detonation, provided that additional constraints, due to the several rate processes that take place in LVD, are imposed on the classical treatment. In essence, he has shown that not all Hugoniot adiabatic states can be accessible from a given initial state, if the precursor shock acts to couple rate processes ahead of the reaction shock front with rate processes behind this front. The solution of the Rankine-Hugoniot (classical detonation)

equations for a steady LVD then becomes a minimization problem where the LVD velocity is the minimum velocity consistent with the constraints imposed by the coupled rate processes D) *Inhomogeneity of the Detonation Wave Front in LE*. The studies of Shchelkin (Ref 8), White (Ref 11) and others have demonstrated that the detonation in most gaseous explosives is unstable and the detonation wave front has a turbulent structure. The investigations of Dremin and co-workers (Refs 13a, 17a, 17b, 20 & 22), Mallory (Ref 19), Urtiew & Kusubov (Ref 26b), Watson (Ref 26d), Persson (Ref 26c), Seely et al (Ref 26) & Cook and co-workers (Ref 32) have shown similar effects in the detonation wave fronts of LE. However, inhomogeneities in the wave front were observed only for rather "insensitive" expls, particularly in expls diluted with inert additives. This is understandable if, as suggested by Shchelkin (Ref 8), the size of the inhomogeneities is determined by the reaction time of the expl under classical (C-J) conditions. For "sensitive" LE (eg, NG), these reaction times are short and inhomogeneities are too small to be resolved by instrumentation now available. The problem of wave front instability in all LE is still unresolved. There may be certain LE that behave classically, ie, their detonation fronts are stable, uniform and one dimensional (Ref 18)

The detonation process, at least in "insensitive" LE, can be visualized as follows (Ref 17a): Microinhomogeneities in the LE (eg, fluctuation in density or composition) result in non-uniform reaction rates in the shocked LE. Because reaction rates are so strongly dependent on temp, these perturbations do not attenuate and eventually reach the shock front of the detonation wave and "bend" it, thus creating oblique shocks at its leading edge. Oblique or transverse shocks lead to the formation of triple shock configurations, and to an increase in the temp and pressure behind the oblique shocks over that obtainable behind smooth shocks. This, in turn, makes for more favorable conditions for the initiation of further reaction. At triple wave intersections, conditions for reaction are particularly favorable. Thus the wave front becomes a complex three-dimensional cellular structure, quite different from the classical one-dimensional uniform wave front

E) *Failure Diameter Theory*. Closely associated with the inhomogeneity of the detonation front in LE is the abrupt change from stable constant velocity detonation to detonation failure as the diameter of the LE is decreased. Typically the detonation velocity of many LE will change very slowly as charge diameter is decreased, and at a further slight decrease in diameter to d_f , the failure diameter, detonation failure occurs abruptly, even though the detonation velocity has dropped only about 1% below that at infinite diameter. This phenomenon is inexplicable in terms of the classical theories of the diameter effect on detonation velocity (See Vol 4, pp D641-43). Dremin and co-workers (Refs 13a, 17b & 22) have developed a theory of failure diameter for LE which have non-uniform detonation wave fronts. In its simplest terms this theory states that detonation failure occurs when chemical reactions cease because oblique (transverse) wave interactions disappear. As discussed in the preceding section, most of the chemical reaction for these LE occurs at sites of transverse wave interaction, but it is entirely possible that some interaction sites will not produce chemical reaction. Such no-reaction regions propagate as dark waves. Obviously if the dark waves cover the entire cross-section of the charge, transverse wave interactions cease, and, unless the LE is "sensitive" enough to sustain detonation in a "smooth" shock, failure occurs. However, if the dark waves cover only part of the charge cross-section, detonation proceeds without change in velocity. The mathematical consequences of this theory are given in Ref 17b and further expanded by Enig & Petrone (Ref 26a). Although these quantitative treatments confirm the theory, they are not very useful for *a priori* computations of d_f because they involve parameters that are not usually available for new LE or LE mixtures

That d_f for "insensitive" LE is associated with dark waves is shown by several experimental studies (Refs 26, 26b & 26d) in addition to the Dremin refs cited above

5) *Initiation of Detonation in LE*. The initiation of detonation in LE occurs either heterogeneously or homogeneously. Impact initiation of powdery solid expls is a prime

example of heterogeneous initiation. It is described in detail in the article on Impact, Initiation of Explosion By (pp I35-Rff). Another example of heterogeneous initiation is the shock initiation of LE containing purposely introduced inhomogeneities such as air bubbles, Al or glass beads, etc. Detonations initiated by such hydrodynamic hot spots are described in the article on Hot Spots (pp H170-Lff). The uniform bulk heating of LE is an obvious example of homogeneous initiation, but it is little different from the bulk heating of solid expls which has been described under Ignition (pp I11ff). Several related articles are in Vol 4 such as Decomposition, Thermal; Deflagration; Detonation, Thermal Theories & Thermochemistry and in Vol 2 under Burning and Burning Characteristics. In what follows we will examine in detail the shock initiation of homogeneous (no bubbles etc) LE, since this is an initiation process unique to LE, although it can also occur in perfect single crystals

The classical paper on the homogeneous initiation of LE is that of Campbell et al (Ref 11a). Their views have since received considerable international support (Refs 17, 20, 26e & 31), but have been criticized by Cook (Ref 32, pp 3-4). In this writer's opinion there is considerable confusion and possibly a misreading of the original paper in Cook's criticisms, and they will be omitted, although some of Cook's ideas on the initiation of LE will be presented later

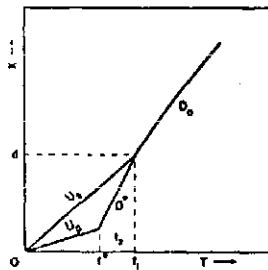

FIG 8. Space-time representation of initiation behavior of nitromethane. The initial shock enters the nitromethane at time 0. U_s = shock velocity, U_p = particle velocity, D_0 = detonation velocity, steady state, D^* = detonation velocity in compressed nitromethane, t^* = induction time

The main ideas of Campbell et al (Ref 11a) are best summarized by reference to the figure above (Fig 8 of Ref 11a). The entering shock heats and compresses the LE. After an induction time or delay of t^* , thermal explosion and detonation occur at the shock entry face where the LE has been hot longest. This de-

tonation travels at a velocity $D^* > D_0$ in the shock-compressed LE until it catches up with the original shock. At this point (d, t_1 in the figure) there is an overdrive in the detonation of the virgin LE, but this decays fairly rapidly to a steady detonation propagating at a velocity D_0 . The overdrive occurs because the particle velocity associated with D^* is higher than that of a normal detonation. Note that the "hyper-velocity" detonation D^* travels a shorter distance than d because the initial shock has imparted a particle velocity U_p to the interface which has consequently moved away from $x = 0$ over a distance $U_p t^*$

In the original Campbell et al paper, NM, molten TNT, molten DINA & Dithekite were the LE examined. Smear cameras, framing cameras & ionization pin pairs were the diagnostic tools. Later studies, by Travis (Ref 15a) using electrical transducers, Dremin (Ref 17), using electromagnetic measurements of particle velocity, and Persson & Sjölin (Ref 26c), using photomultipliers to record detonation luminosity, are in excellent accord with the Campbell et al findings. Subsequent studies by Dremin (Ref 20) and Persson (Ref 26c) showed that NG and EGDN also follow this initiation mechanism. Berke et al (Ref 26e) also found that several liq fluoramino alkanes behave analogously to NM, NG etc. Most of the original and later studies were made with NM as the principal LE. Consequently all our subsequent discussion refers to NM

Table 2 gives average values of the NM parameters measured by Campbell et al (Ref 11a)

Table 2

Shock Velocity U_s (mm/ μ sec)	4.5
Particle Velocity U_p (mm/ μ sec)	1.7
Input Pressure (kbar)	86
Detonation Velocity in Compressed NM, D^* (mm/ μ sec)	10.4
Detonation Velocity Steady State, D_0 (mm/ μ sec)	6.26
Induction Time, t^* (μ sec)	~ 2

The induction time t^* is of particular interest, since it can be compared to the induction time computed for an adiabatic thermal explosion (See Ref 6, pp 173-74 or Eq 6 of Article on Hot Spots, p H172-R) to provide a check on the correctness of the supposition that the input shock generates a thermal explosion (at the shock entry face). Unfortunately, an exact quantitative treatment of the induction times of shock-generated thermal explosions suffers from: a) uncertainty of the shock-generated temperature in the LE and b) uncertainty in the Arrhenius kinetic parameters (activation energy and pre-exponential factor) (See Kinetics in this Vol)

Campbell et al (Ref 11a) claim to have obtained reasonable agreement between observed and computed induction times. They computed their shock-generated temps on the basis of constant specific heat, ie, no increase in C_v with an increase in temp. It is to be expected that C_v for liquids increases with increasing temp and this expectation has been confirmed for NM (Ref 31). Thus the Campbell et al temperatures of about 1170°K for the conditions shown in Table 2 are too high. Based on recent studies (Ref 31) these temps should be about 1050°K. This means that a lower activation energy than that used by Campbell et al is necessary to get agreement between observed and computed induction times for NM shock-heated to 1050°K. Although the above discussion suggests that quantitative agreement between experiment and theory is still to be achieved, the qualitative model for the shock initiation of LE appears to be on solid ground

Cook and his co-workers have championed a different model for the shock initiation of LE (Refs 6, pp 173-94 & 32, pp 292-96). In essence, this model states that initiation occurs when a shocked region of LE becomes "thermally superconductive" (as a result of rising temp due to partial decompn of the shocked LE) and a "heat pulse" flashes across the shocked LE and catches up with the original shock front. As described in the article on Heatpulse (p H59-L), alternate explanations are possible for some of the observations that Cook considers to be the main experimental support for his "heat pulse". Similarly, Dremin et al (Ref 17) have suggested an alternate ex-

planation for the phenomenally rapid "flash-across" observed in some shock initiation experiments with LE

6) *Brief Abstracts of Recent Publications on LE:*

a) Effect of Pressure on the Burning of LE. An abrupt change in the burning of some LE occurs as pressure on the LE is increased. Two alternate explanations for this effect are: 1) gas phase reactions are moved closer to the liq surface by increasing pressure, thus transferring more heat to the LE and 2) increase in the burning rate generates turbulence in the combustion front which then increases the heat exchange between combustion gases and the LE. Experiments with EGDN and EGDN gelled with a small amount of NC favor explanation (2)

Ref: K.K. Andreev et al, *RussJPhysChem* **35** (2), 204 (1961)

b) Initiation of LE by Gas Phase Detonation. Detonation of stoichiometric methane-oxygen gas mixts was used to initiate liquid TNM-benzene mixtures. For 1.5/1 (by volume) TNM/benzene, initiation occurred only at initial gas pressures above 2 atm. Initiation delay decreased with increasing initial gas pressure. For 4/1 (by volume) TNM/benzene (stoichiometric) the critical initial gas pressure was 0.66 atm. The influence of initial pressure is explained in terms of more efficient heat transfer from the gas detonation to the LE, but there are compensating effects and the surface temp of the LE varies only mildly with initial pressure
Ref: V.E. Gordeev et al, *FizGoreniya i Vzryva* **1** (2), 12 (1965) & *CA* **64**, 1894 (1966)

c) A Generalized Shock Hugoniot for Organic Liquids. The shock compressibility (Hugoniot) (See pp H179-Lff) of organic liquids, including several LE, is expressed in the following general form:

$$U = 1.2C_0 + 1.7\mu$$

where U is shock velocity, C_0 is ambient sound velocity in the liq and μ is particle velocity
Ref: I.M. Voskoboinikov et al, *FizGoreniya i Vzryva* **3** (4), 585 (1967) & *CA* **69**, 37522 (1968)

d) Initiation of LE by High Intensity Light. Stoichiometric mixts of TNM/benzene (See abstract b) were initiated by the radiation of an argon flash bomb. Chemical decompn of

NG was observed under these conditions but no detonation. The possibility of light, produced by the shock compression of air pockets in porous expls, contributing to the initiation and propagation of detonation in porous expls is discussed

Ref: A.N. Dremin & S.D. Savrov, *Doklady-AkadNauk* **179** (3), 624 (1968) & *CA* **68**, 116108 (1968)

e) Deflagration to Detonation Transition in LE. High-speed photography was used to study the growth of explosion in various liq expls. The liquids investigated included NG, NM/HNO₃ mixts, H₂O₂/Ethanol mixts and DEGDN. In one experimental arrangement, a thin film of expl was confined between transparent plates. Deflagration at the center of the film was initiated by the rapid discharge of a condenser across a spark gap. The study allowed the growth of the burning and the transfer to detonation to be photographed in detail

Ref: G.D. Coley & J.E. Field, *ProclntnCongr-HighSpeedPhotogr* **1970**, p 466 & *CA* **75**, 89718 (1971)

f) LE consisting of hydrazine, Hydrazine Nitrate, water (with & without added ammonia or AN) & a thickening agent is claimed. This appears to be one of the "Astrolite" expls

Ref: R.M. Bridgeforth et al, *USP* 3523047 & *CA* **74**, 14701 (1971)

g) Calculated Shock Temperatures for LE. A modification of Walsh-Christian model for metals was used in calculating shock temps in NM, liq TNT and four liquid Bis(Difluoramino) Alkanes. In this modification the heat capacity increases with temp rather than staying constant as in the Walsh-Christian model

Ref: R. Shaw, *JChemPhys* **54**, 3657 (1971)

Written by J. ROTH

Refs: 1) VanGelder & Schlatter (1927), 396
2) C.J. Bain, "Tests of Liquid Nitrogen Explosive", *PATR* **985** (1939) 3) A. Stettbacher, *TechIndSweizChemZtg* **24** (1941) & *CA* **36**, 4339 (1942) 4) Davis (1943), 353-55
5) L.H. Eriksen, "Properties of Liquid Explosives", *PATR* **1524** (1945) 5a) L.H. Eriksen, "Sensitized Nitromethane Liquid Explosives for Mine Field Clearance", *PATR* **1565** (1945)

5b) L.H. Eriksen, "Sensitized Nitromethane Liquid Explosives for Mine Field Clearance", *PATR* **1660** (1947) 5c) S. Axelrod, "Liquid Explosives", *PATR* **1681** (1948) 6) Cook (1958), 14, 173-74 & 190-94 7) M.A. Cook et al, 3rd ONR SympDeton (1960), 150 8) K.I. Shchelkin, *ZhurEksptl i TeoretFiz* **36**, 2 & 600 (1959) & *CA* **53**, 15724 (1959) 8a) K.K. Andreev & A.F. Belyaev (1960), 197-98 9) I.M. Voskoboinikov & A. Ya. Apin, *Doklady* **130**, No 4, 854 (1960) & *CA* **56**, 619 (1962) 10) I.M. Voskoboinikov & G.S. Sosnova, *ZhurPrikladMechk i TeckhFiz* No 4, 133 (1961) & *CA* **56**, 3712 (1962) 11) D.R. White, *PhysFluids* **4**, 498 (1961) 11a) A.W. Campbell et al, *PhysFluids* **4**, 498 (1961) 12) C.L. Mader, *Los Alamos Rept LA-2900* (1963), 14-17 13) J.T.A. Burton & J.A. Hicks, *Nature* **202**, 758 (1964) 13a) A.N. Dremin & V.S. Trofimov, *Zhur-PrikladMekh i TekhFiz*, No 1, 126 (1964) & *CA* **61**, 1698 (1964) 14) W.C. Davis et al, *PhysFluids* **8**, 2169 (1965) 15) R.W. Watson et al, 4th ONR SympDeton (1965), 117 15a) J.R. Travis, *Ibid*, 609 16) J.H. Blackburn & L.B. Seely, *TransFaradSoc* **61**, 537 (1965) 17) A.N. Dremin et al, *Combus-Expl & ShockWaves* **1**, 1 (1965) 17a) A.N. Dremin & O.K. Rozanov, *Combus Expl & ShockWaves* **1** (2), 63 (1965) 17b) A.N. Dremin & V.S. Trofimov, 10th SympCombstn (1964), 839 18) A.N. Dremin & S.D. Savrov, *FizGoreniya i Vzryva* **1**, 36 (1966) 19) H.D. Mallory, *JApplPhys* **37**, 4798 (1966) 20) A.N. Dremin et al, *FizGoreniya i Vzryva* **3**, 11 (1967) 21) Anon, *MachineDesign* **40**, No 28, 6 (1968) 22) A.N. Dremin, 12th SympCombstn (1969), 691 23) G. Cohn, *Edit, Expls&Pyrots* **2**, No 6, 1 (1969) 24) B. Johnson, *Ordn* **53**, 613 (1969) 25) G. Cohn, *Edit, Expls&Pyrots* **2**, Nos 7 & 8 (1969) 26) L.B. Sealy et al, 5th ONR SympDeton (1970), 89 26a) J.W. Enig & F.J. Petrone, *Ibid*, 99 26b) P.A. Urtiew & A.S. Kusubov, *Ibid*, 105 26c) P.A. Persson & T. Sjölin, *Ibid*, 153 26d) R.W. Watson, *Ibid*, 169 26e) J.G. Berke et al, *Ibid*, 237 27) W.R. Tomlinson Jr & O.E. Sheffield, *EngDesHndbk*, "Properties of Explosives of Military Interest", *AMCP* **706-177** (1971) 28) R.F. Chaiken, *AstronauticaActa* **17**, 575 (1971) 29) Anon, *EngDesHndbk*, "Principles

of Explosive Behavior", *AMCP* **706-180** (1972) 30) B.M. Dobratz, "Properties of Chemical Explosives and Explosive Simulants", *UCRL-51319* Rev 1 (1974), Lawrence Livermore Laboratory, Livermore, Calif 31) P.C. Lysne & D.R. Hardesty, *JChemPhys* **59**, 6512 (1973) 32) M.A. Cook, "The Science of Industrial Explosives", Graphic Service & Supply Co (IRECO Chemicals, Salt Lake City, Utah) (1974), 16, 292-96, 298 & 300-01

LIQUID PROPELLANTS

Definitions & Overview. Liquid Propellants (LP) are liq substances that can be transformed into gases (usually hot) which act as driving jets in a propulsion system. Propulsion systems can be divided into *rockets* and *jet engines*. The forward thrust of both rockets and jet engines is generated by the rearward ejection of a fluid jet thru nozzles mounted on the rocket or jet engine (Ref 12, pp 439-41). In a rocket this fluid jet originates entirely from containers (tanks) within the rocket. Jet engines, on the other hand, ingest the surrounding medium (air or water) to produce their exhaust jet. Thus rockets can function in a vacuum (space) whereas turbojets, ramjets etc, cannot. Since Jets are described in this Vol (See under Jet Fuels, pp J68-R ff) this article deals primarily with rockets and liquid rocket propellants

It is usually understood that a rocket motor is that part of the propulsion system in which the propellants are transformed into the exhaust jet, while a rocket engine is the entire system, ie, the rocket motor, the proplnt containers, pumps, etc. In conventional solid proplnt rockets, the motor and the engine happen to be the same piece of apparatus, but this is not so in liq proplnt rockets

Liquid Propellants, sometimes called *Propergols* if used for rocket propulsion (Ref 23), are divided into two classes: *monopropellants* and *bipropellants*. A monopropellant is a single substance or a homogeneous compatible mixt that can be caused to react in the rocket motor (combustion chamger) to generate the gases that form the exhaust jet. A bipropellant consists of two liq reactants - usually a fuel and an oxidizer. The gas-forming process in a monopropellant is initiated by heat and/or catalysts.

These agents can also initiate the gas formation of bipropellants after the components are mixed. Certain bipropellants can, however, self-ignite merely upon mixing. These are called *Hypergolic Propellants* or *Hypergols* (See *Hypergolic Propellants* in this Vol, pp H254-L to H259-R)

Levy (quoted in Ref 23) also suggested the following additional designations: *Catergols* are LP that are decomposed by the action of catalysts; *Monergols* are homogeneous liquid bipropellants; *Lithergols* are heterogeneous bipropellants, eg, solid C & liquid oxygen

LP are often classified into storable and cryogenic liquids. The former, as implied, are stable liquids under ambient operating conditions. The latter require a liquefying plant as they are gases under ambient conditions

A universally accepted measure of the effectiveness of LP is the specific impulse, usually designated by I_{sp} . It is defined by:

$$I_{sp} = c/g \text{ and}$$

$$c = V_e + (p_e - p_\infty)A_e/\dot{m}$$

where

V_e = exhaust jet velocity

p_e = static pressure at the exhaust

p_∞ = ambient pressure

A_e = area of exhaust nozzle

\dot{m} = rate of exhaust mass flow

g = acceleration of gravity

The units of I_{sp} are (lb-sec)/lb or, as commonly used, sec (by cancelling the lbs in the numerator and denominator). For further details on the measurement & computation of I_{sp} see Ref 12, pp 440-4 & 464-71

Subjects related to LP were previously described in the following Encyclopedia articles: *Burning & Combustion*, Vol 2, pp B351 & B361, with additional Refs in Vol 3, pp C425-8 & in Vol 4, pp D173-75; *Hydrazine, Its Salts and Derivatives* in this Vol, pp H190-L to H206-R; *Hydrogen Peroxide* in this Vol, pp H218-R to H222-L; *Hypergolic Propellants* in this Vol, pp H254-L to H259-R; *Ignition* in this Vol, pp I11 to I30-R; *Jet Propulsion* in this Vol, pp J77 to J83; *Liquid Explosives* in this Vol, pp L26 to L34

General references on the subject of LP are: Refs 7, 9-15, 17, 18, 21, 23 & 27-29

In the present article we will review:

1) LP History

- 2) Representative LP Compositions
- 3) Representative LP Applications
- 4) Performance Characteristics of LP
- 5) Sensitivity and Hazards of LP

1) *History*. An excellent overview of the history of liquid propellants, LP, and propulsion systems using LP is given by Malina (Ref 12, pp 10-23) and Truax (Ref 12, pp 23-26). In what follows we draw heavily on this overview. The history of LP is conveniently divided into three periods: Pre-WWII, WWII & Post-WWII

Pre-WWII. The use of LP for space travel appears to have been first suggested by Ziolkowsky in 1898, but not published until 1903 (Ref 1). He also suggested the "piggy-back" launch, ie, a rocket launched from another rocket, although this principle had been used much earlier in fireworks displays

The subject of LP remained quiescent early in the 20th century and thru WWI. In 1928, Esnault-Pelterie (Ref 2) lectured on LP combustion problems. Between 1930 & 1933 the Verein für Raumschiffahrt (Society for Space Travel) experimented with LP engines using combinations of liq oxygen and gasoline or aq alcohol (Ref 12, pp 10-23). This society was the precursor of the group that developed the V-2 rocket during WWII

The American Rocket Society began experimenting with LP in 1932, using primarily liq oxygen-gasoline systems. Their work was later summarized by Wyld (Ref 6). In 1941 several members of this society formed Reaction Motors, Inc to produce the liq oxygen-alcohol engine for the Bell X-1 supersonic aircraft. In 1936 Goddard summarized his studies of LP (Ref 3). His studies dealt more with combustion chamber design and functioning than with specific LP. The Guggenheim Aeronautical Laboratory was started in the same year at the California Institute of Technology for the purpose of studying design fundamentals of solid and liq propulsion systems. A year later, Malina (Ref 4) published a paper on the characteristics of LP motors

These developments up to 1940 are well summarized by Malina (Ref 12, pp 10-23) and we quote:

"The literature published up to 1940 shows that the basic problems of designing successful liquid propellant engines were correctly stated,

at least in major outline. The properties of a number of propellants were fairly well known, especially those combinations using liquid oxygen as the oxidizer. In connection with the rocket motor, the thermodynamics of the combustion process and of the flow of the gaseous products thru the exhaust nozzle to produce thrust, were understood; and a beginning had been made in solving the cooling problem, and the preliminary stages of development of suitable systems of propellant supply had also been reached. It may be noted that the greatest advance to be recorded in this article was the mechanical design of the complete engine, although a number of basic discoveries were made, especially in the domain of propellants, and the theory for guiding design was greatly expanded."

WWII. From 1932 onward, the study of LP and LP engines proceeded under a cloak of secrecy in Germany. Much of this effort was concentrated at an Army establishment at Peenemunde. This work culminated in the development of the V-2 rocket (originally called the A-4) in 1942. The LP of the V-2 consisted of liq oxygen mixed with 75/25 ethanol/water. Mixing pumps were driven by an impulse turbine powered by steam from a hydrogen peroxide generator. This rocket motor delivered a 55,000 lb thrust, at sea level, for 65 seconds to give an average specific impulse of 223 lb-sec/lb. The original V-2 traveled a distance of 120 miles

Similar LP systems were also developed and used at Peenemunde for jet-assisted take-off for aeroplanes (See JATO in this Vol, pJ67-L

The Germans also developed LP systems based on hydrogen peroxide both by itself and mixed with fuels. The specific impulse of decomposing 80% hydrogen peroxide ("cold" engine) was a rather low 155 lb-sec/lb. This was raised to 210 lb-sec/lb by burning hydrogen peroxide with a fuel mixture of 30/57/13 hydrazine hydrate/methanol/water. Mixtures of hydrogen peroxide and hydrazine hydrate are hypergolic (Self-igniting - See Hypergolic Propellants (pp H254-L to H259-R) and Hydrazine, Its Salts and Derivatives, pp H190-L to H206-R, in this Vol. These LP were used mostly in turbo pumps for Jet aircraft

Work on LP engines using nitric acid as the oxidizer was carried out at the Bayerische

Motoren Werke (BMW). By 1945 some 6000 fuel-nitric acid mixtures had been tested. Some of these were hypergolic

During WWII LP research in the USA was concentrated at the Jet Propulsion Laboratory of the California Institute of Technology, Aerojet Engineering Corp, Reaction Motors, Inc, and the Navy Bureau of Aeronautics. These efforts are summarized in books by Zucrow (Ref 7) and Sutton (Ref 9)

One of the main LP developments of the Jet Propulsion Lab efforts, later commercialized by Aerojet, was the nitric acid-aniline JATO engine. Monopropellant engines were also investigated

Liquid oxygen-alcohol proplnts were studied at Reaction Motors, and resulted in the 1500 N4C engine, which powered the experimental X-1 supersonic airplane (Ref 5)

The Bureau of Aeronautics investigated nitric acid-aniline proplnts for JATO's for large flying boats such as the *PBY-2* (Ref 8). They also developed a prototype engine for the *Gorgon*, a radio-controlled winged missile. The proplnt for *Gorgon* was a combination of mixed nitric-sulfuric acids and monoethylaniline

Post-WWII. After WWII most LP R&D shifted from Germany to the USA and the USSR. Technical progress since 1945 in LP for rockets can be characterized by a host of minor improvements rather than major advances, and some spectacular applications of LP in rockets for military use and for space exploration, eg, in ICBM's (Intercontinental Ballistic Missiles) and in USA & USSR Moon, Mars & Venus "shots". Thus the major developments since WWII have been primarily in the application of existing, though improved, propulsion systems to such highly publicized rockets as Sputnik, Vanguard, Soyuz, Saturn, Vostok, Apollo, Explorer, etc

Efforts in LP per se have been largely restricted to improving performance by increasing the combustion pressure, and the developing and testing of "exotic" mono and biproplnts, such as the NF compounds and Fluorine-NH₃ and Fluorine-H₂ biproplnts (See Sect 2). So far there is no mention in the open literature of the practical use of "exotic" proplnts (Ref 30, p 312)

2) *Representative LP Compositions*. Compared to the vast number of possible or even

Table 1

Constituents		Oxidant: Combustible Ratio	Specific Gravity, g/cc	Specific Impulse, sec	Remarks
Oxidant	Combustible				
100% Nitric acid	Turpentine	4.4	—	221	} Fuels most commonly used
Fuming Nitric acid (FNA)	Ethanol	2.5	—	219	
FNA	Aniline	3.0	—	221	
FNA	Ammonia	2.2	—	225	
FNA	JP-4	—	—	225	
99% Hydrogen peroxide	Ethanol	4.0	—	230	
99% Hydrogen peroxide	JP-4	6.5	—	233	
99% Hydrogen peroxide	Hydrazine	—	—	245	
Liquid oxygen (LOX)	Ethanol	1.5	0.97	242	
LOX	JP-4	2.2	1.02	248	
LOX	Turpentine	2.2	—	249	
LOX	Ammonia	1.3	—	250	
Hydrogen peroxide	Nitromethane	—	—	227	} So-called "Zip-fuels" (high energy fuels in the USA) } Fuels most commonly used
N ₂ O ₄	Hydrazine	—	—	249	
N ₂ O ₄	Hydrogen	11.5	0.565	279	
FNA	Hydrogen	12.6	0.60	298	
LOX	Hydrogen	2.9	0.23	345	
70% LOX	} JP-4	2.3	—	253	
30% Ozone					
100% Ozone	JP-4	1.9	—	266	
100% Ozone	Ammonia	1.13	—	267	
100% Ozone	Hydrazine	0.63	—	277	
Fluorine	JP-4	2.6	—	265	
Fluorine	Ammonia	2.6	—	288	
Fluorine	Diborane (B ₂ H ₆)	5.0	—	291	
Fluorine	Methanol	2.37	—	296	
Fluorine	Hydrazine	1.98	—	298	
Fluorine	Hydrogen	4.5	—	352	
Fluorine	Hydrogen	9.4	0.46	371	
100% Ozone	Hydrogen	3.2	—	369	
100% Ozone	Hydrogen	2.65	0.23	373	

practical bipropellant compositions, very few monopropellants have been studied and even fewer are used. The following monopropellants have been investigated:

Hydrogen Peroxide, Hydrazine, Nitromethane, sym-Dinitromethane and Methyl Nitrate in ethanol (Refs 10 & 23). Of these only Hydrazine and Hydrogen Peroxide have been used and are being used in practical propulsion systems

As stated above, many oxidizer-fuel combinations are usable as bipropellants. However, the

number of usable oxidizers is fairly limited. Storable oxidizers include: nitric acid (with and without added NO₂), Hydrogen Peroxide, perchloric acid, Tetranitromethane, N₂O₄, & ClF₃. Of these only nitric acid and Hydrogen Peroxide are of practical use. Perchloric acid or Tetranitromethane are too explosive when mixed with fuels, and N₂O₄ or ClF₃ are not really storable, as they boil at 22° and 12° respectively (Refs 10 & 23)

The most commonly used cryogenic oxidizer is liquid oxygen (LO). Other cryogenic oxidizers

include: N_2O_4 , ozone, fluorine, chlorine-trifluoride (ClF_3), nitrogen tetrafluoride (NF_4), bromine pentafluoride (BrF_5), perchloryl fluoride (ClO_3F), fluorine monoxide (F_2O), and fluorine dioxide (F_2O_2) (Refs 10, 23 & 28)

Vast numbers of fuels may be combined with the above oxidizers to form bipropulants. Many hypergolic bipropellant systems are listed in this Vol, pp H254-L to H259-R, under Hypergolic Propellants. The foregoing tabulation (Table 72, p 317 of Ref 23) lists several "common" bipropulants

Other, generally more "exotic" bipropulants are given in Table 10.2, p 165 of Ref 28 which is shown as Table 2 below:

then the reaction products will consist of low molecular weight compounds at high temps, thus assuring good performance;

c) The propulants should have large densities in order to minimize the dead weight of storage tanks;

d) The oxidizers and reducing agents are best handled as liquids. Hence it is desirable to obtain propulants which are normally liq in the operating temp range of service units (ie, from about -40 to $+60^\circ$). For substances such as liquid oxygen and hydrogen special cooling units must be provided;

e) Since it may be necessary to store the propulants for long periods of time before use,

Table 2
Properties of Liquid Propellant Systems

Fuel	Oxidant	Oxidant/ fuel ratio	I_s (sec)	Endothermicity of fuel ($\Delta H_f^{\circ},_{298^\circ}, (g), kcal/mole$)	T_c ($^\circ K$)	T_e ($^\circ K$)	M_E	Products at T_E ($> 5\%$ of total)
H_2	O_2	4.00	391	0	2980	1350	10.08	H_2O, H_2
B_2H_6	O_2	2.00	344	7.5	3846	2592	20.32	H_2, HBO_2, B_2O_3
C_2H_2	O_2	1.80	327	54.2	4172	2600	24.07	CO, H_2O, H_2, CO_2
N_2H_4	O_2	0.90	313	22.8	3410	1928	20.29	H_2O, N_2, H_2
Kerosene	O_2	2.60	301	-5.9	3623	2228	25.29	H_2O, CO, CO_2, H_2
H_2	F_2	9.00	410	0	4117	2018	13.64	HF, H_2
B_2H_6	F_2	5.20	371	7.5	4934	3130	22.52	HF, BF, H_2, H
C_2H_2	F_2	1.50	306	54.2	4109	3294	29.96	$HF, C(s)$
N_2H_4	F_2	2.30	363	22.8	4687	2702	21.33	HF, N_2, H_2
Kerosene	F_2	2.40	317	-5.9	3917	2748	25.26	$HF, C(s)$
H_2	F_2	9.00	410	0	4117	2018	13.64	HF, H_2
H_2	O_2	3.50	424	34.1	3123	1426	9.07	H_2, H_2O
H_2	F_2O	5.90	410	8	3589	1662	11.36	H_2, HF, H_2O
H_2	NF_3	13.30	350	-29.7	3868	1682	16.43	HF, H_2, N_2
H_2	ClF_3	11.50	318	-39	3390	1356	16.78	HF, H_2, HCl
H_2	F_2O_2	5.00	407	4.7	3362	1504	10.57	H_2, HF, H_2O

Penner (Ref 10) has listed eleven attributes that make an ideal liq bipropellant system. We quote some of them below:

"a) Small negative or preferably positive standard heats of formation of the reactants;

b) The reaction products should have low molecular weights and large negative heats of formation. If conditions (1) and (2) are met,

good propulants should have high storage stability, ie, they must not decompose or change chemically in any way during storage so that their use as a propellant is impaired;

f) For large-scale use it is, of course, imperative that propulants which are readily available and preferably also of low cost are employed. In practice this last requirement is

essential since experience has shown that rare and expensive chemicals which are needed in large quantities usually become cheap and readily available in the course of time;

g) The bipropellant mix in a liq-fuel rocket should be spontaneously combustible with minimum time lag; and

h) The reaction products should not be excessively corrosive or form solid deposits thereby leading either to increased or decreased nozzle throat diameters"

3) *Representative LP Applications.* Before proceeding with a description of the specific uses of LP, it is instructive to compare them with solid propellants. The choice between LP and a solid propellant for a given application depends on several factors such as: specific impulse, safety, storability, rocket engine design & special requirements

LP generally have the following advantages over solid propellants:

a) Higher Specific Impulse; b) Rocket engines with LP can be precisely calibrated prior to launching; and c) Rocket engines with LP can be throttled and even restarted after complete throttling

LP generally have the following disadvantages compared to solid propellants:

a) More complex and less rugged rocket engines; b) Poorer stability; and c) Poorer reliability

The most spectacular, though hardly the most elegant, use of LP was in the first stages of early ICBM and space exploration rockets. These used clusters of LP engines to achieve lift-off via "brute force". For example, the original Sputnik, Vostok, Atlas, Titan, Vanguard, Thor, Apollo & Saturn used clusters of engines powered with liquid oxygen/kerosene mixtures for the lift-off stage (Refs 30a & 32). More specifically, Saturn I had a cluster of eight liquid oxygen (LO)/kerosene H-1 rockets. Later Saturns and Titans used LP of higher I_{sp} , eg: Saturn-II and Saturn-IVB used LO/liq Hydrogen; Post 1959 Titans used N_2O_4 /Hydrazine derivatives; Jupiter-C used LO/Hydrazine derivatives; and the French Diamant I space booster used nitric acid/turpentine (Ref 32)

More sophisticated uses of LP, which take advantage of the LP engine's capability of being throttled and restarted, are in thrusters.

Thrusters are rockets for maneuvering and controlling the attitude of space vehicles. The usual monopropellant for thrusters is catalytically decomposed Hydrazine. The usual catalysts are iridium, rhodium or ruthenium and their mixts. For a review of Hydrazine thrusters see Refs 33, 34 & 35. Russi (Ref 34) emphasizes that, in spite of many studies and the general acceptance and apparent success of hydrazine thrusters, new rocket motor design is still largely empirical. A bipropellant consisting of Hydrazine mixed with Hydrazine Nitrate has also been tried in thrusters but is no longer popular

An informative compilation of the uses of LP is given in Table 3 from Ref 30a

The two interesting applications of LP are in gas generation and in specialized ammunition

The use of a monopropellant gas generator offers significant advantages over conventional solid propellants because of its capability for variable demand operation, high performance, solids-free exhaust and constancy of flow over a wide temp range. The monopropellant gas generator eliminates the need for filters and design compromises such as oversize propellant grains to account for the variation in burn rate over the temp range of -65 to $+165^\circ\text{F}$ (Ref 24)

Ammunition containing bulk-loaded monopropellants have the characteristics of low flame temp, high energy, reduced smoke and flash, and reduced fouling and longer barrel life. There is one disadvantage, however, that has prevented exploitation of these good attributes. Liq monopropellants do not burn stably under the conditions existing in bulk-loaded cartridges. High and erratic pressures occur, accompanied by high frequency, high amplitude pressure excursions. It was shown that bulk loaded monopropellants, eg, alkyl nitrate mixtures, encapsulated to form small spheres, produced propellants of very repeatable and uniform initial surface area similar to conventional smokeless ball powder. Proper ignition and the resulting combustion involving the liquid droplets prevents agglomeration into a large unstable bulk (Ref 25)

Table 3
Current Liquid Bipropellant Applications

Propellant System,	Engine System, Common Designation	Thrust Level, lbs.	Application Area
LO ₂ /RP-1 (a)	Thor	170,000	Space booster, IRBM (Delta 1st stage)
	H-1	200,000	Uprated Saturn I
	Blue Streak	300,000	Space Booster
	Titan I	300,000 (1st stage) 80,000 (2nd stage)	ICBM
	Atlas	370,000-390,000	Space booster, ICBM
LO ₂ /H ₂	F-1	1,500,000	Saturn V, S-IC
	Centaur	15,000	Uprated Saturn I SIII (2 engines) Saturn I, SII (6 engines) Saturn V, SII & SIII
LO ₂ /NH ₃	J-2	200,000	Experimental rocket plane
LO ₂ /C ₂ H ₅ OH	X-15	15,000-58,000	SRBM
H ₂ O ₂ /JP-4 (1), JP-5 (a)	Redstone	75,000	Auxiliary rocket engine for aircraft
	AR-2, 3	3300-6600	Auxiliary rocket engine for aircraft
IRFNA (b)/UDMH (c)	Warrior	3500-10,200	Space booster (Delta 2nd stage)
	AJ10-118	7500	Surface-to-surface missile
	Lance		Space booster (2nd stage)
IRFNA (b)/MAF-1 (d)	Agna	16,000	Air-to-surface missile
IRFNA (b)/MAF-3 (e)	Bullpup		Air-to-air missile
IRFNA (b)/MAF-4 (f)	TD-174		Target drone
IRFNA (b)/JP-4 (a)	P4	550 (booster) 106 (sustainer)	Sounding rocket
	Aerobee 100 sustainer	2600 (total)	Sounding rocket
IRFNA (b)/aniline- furfuryl alcohol	Aerobee 150 and 150A sustainer	4100 (total)	Sounding rocket
IWFNA (g)/turpentine	Emeraude	62,700	Space booster
N ₂ O ₄ /N ₂ H ₄ - UDMH (c) (50-50)	Apollo service module RCS	100	Reaction control
	Ullage rocket	1750	Saturn V, S-IVB Ullage Control

(continued)

Table 3 (continuation)

Propellant System,	Engine System, Common Designation	Thrust Level, lbs	Application Area
N ₂ O ₄ /N ₂ H ₄ - UDMH (c) (50-50)	AJ10-131	2200	General purpose space engine
	F750 L2.2K	2200	Multiple restart space engine
	Lunar module ascent engine	3500	Lunar module liftoff (moon)
	F720 L8.OK	8000	Multiple restart space engine
	Transtage	8000	Upper stage propulsion
N ₂ O ₄ /N ₂ H ₄ - UDMH (c) (50-50)	Lunar module descent engine	1050-10,500	Lunar landing engine
	Apollo service module	21,900	Space propulsion
	YLR113-AJ-1	50,000-150,000	Rocket sled
	Titan II	430,000 (1st stage) 100,000 (2nd stage)	Space booster, ICBM
	N ₂ O ₄ /MMH (h)	Advanced Syncom RCS	5
Gemini RCS		25 (two 8-engine sets)	Reaction control
Transtage ACS		25 (4 engines) 45 (4 engines)	Attitude control
Apollo command module		93 (two 6-engine sets)	Attitude control
N ₂ O ₄ /MMH (h)	Gemini OAMS	25 (8 engines)	Orbital change
		85 (2 engines)	
		100 (6 engines)	
	Radiomic	85-100	General purpose attitude control

- a) RP-1, JP-4 & JP-5: Kerosene Fractions
b) IRFNA: Inhibited Red Fuming Nitric Acid
c) UDMH: Unsym Dimethyl Hydrazine
d) MAF-1: 50.5% DETA, 40.5% UDMH, 9% CH₃CN
e) MAF-3: 80% DETA, 20% UDMH
f) MAF-4: 40% DETA, 60% UDMH
g) IWFNA: Inhibited White Fuming Nitric Acid
h) MMH: Monomethyl Hydrazine

4) Performance Characteristics of LP.

Specific impulse, I_{sp} , probably the most accepted measure of LP performance, was defined in Sect 1 and tabulated in Tables 1 & 2. The thrust, F , of a rocket is given by

$$F = \dot{m}c$$

where \dot{m} and c were also defined earlier. Typical thrust levels for "practical" LP systems are given in Table 3. For an ideal rocket other performance parameters are: T_c = adiabatic combustion temperature; T_E = exhaust gas temperature; c^* = characteristic velocity; C_F = thrust coefficient; M_E = mean molecular weight of exhaust gases; $\bar{\gamma}$ = average ratio of specific heats of exhaust gases

According to Summerfield (Ref 12, p 442):

"The ideal rocket motor analysis rests on the following simplifications: (a) the propellant gas obeys the perfect gas law; (b) its specific heat is constant, independent of temp; (c) the flow is parallel to the axis of the motor and uniform in every plane normal to the axis, thus constituting a one-dimensional problem; (d) there is no frictional dissipation in the chamber or nozzle; (e) there is no heat transfer to the motor walls; (f) the flow velocity in the chamber before the nozzle entrance is zero; (g) combustion or heat addition is completed in the chamber at constant pressure and does not occur in the nozzle; and (h) the process is steady in time."

With these simplifications typical computed values of LP rocket performance (according to Ref 12, pp 453-64) are given in Table 4

Additional computational results are given in Table 2 which also shows major exhaust gas products. Parametric charts of rocket performance for specific missions are given by Jortner (Ref 17, p 471). Further data on rocket performance from the point of view of weight and volume limited systems are presented by Mellish & Gibb (Ref 17, P 447)

At the high combustion and exhaust temps shown in Tables 2 & 4, many of the combustion products will dissociate (eg $CO_2 = CO + \frac{1}{2}O_2$; $H_2 = 2H$, etc). The effects of product gas dissociation constitute the greatest source of inaccuracy in the above ideal rocket analysis

Additional departures from ideal behavior result from:

- a) Conical divergence of the exhaust jet;
- b) Surface friction and flow disturbances in the exhaust nozzle;
- c) Constriction of the exit area due to boundary layer build up;
- d) Jet detachment;
- e) Heat loss from the hot gas to the cold motor walls;
- f) Suspended liquid or solid particles in the exhaust jet; and
- g) Pressure drop in the combustion chamber due to heat release.

They are discussed in detail in Ref 12, pp 464-71

A detailed description of LP Rocket Systems is beyond the scope of this article. An excellent account of many of the facets of LP rockets, such as combustor design, cooling, pressurization prior to combustion, and pump systems, is given in Ref 12, pp 475-516

Table 4
Typical Performance Characteristics

Performance parameter	Ordinary range	High range
T_c	2000-3000 K	3000-5000 K
c^*	4000-5500 ft/sec	5000-8000 ft/sec
C_F	1.3-1.5	1.5-1.6
I_{sp}	200-270 lb-sec/lb	270-400 lb-sec/lb
M_E	20-25	8-20
$\bar{\gamma}$	1.15-1.25	1.15-1.20

5) *Sensitivity and Hazards of LP*. Some monopropellants and some well-mixed bipropellants exhibit detonation characteristics typical of Liquid Explosives (See Sects 4 & 5 of article on Liquid Explosives in this Vol). However, bipropellants usually do not sustain complete detonation, i.e., a rather small portion of the bipropellant undergoes something akin to detonation and the remainder deflagrates (Ref 26). Of course even this partial detonation can be very dangerous and destructive. LP are also subject to another phenomenon which is potentially destructive (at least to the rocket), namely combustion instability (Refs 16 & 22)

The two stage explosion process of most bipropellants, i.e., "detonation" followed by deflagration, manifests itself in the explosion fire-ball and the impulse delivered by such explosions. Both fireball and impulse (at least close to the explosion) for typical bipropellants are larger than for the same weight of TNT, but shock pressure is considerably less. Thus the main hazard of a distant bipropellant explosion are its thermal effects. Nearby, this explosion can also be destructive to organisms and structures that are affected by impulse and large low-velocity fragments. It has been suggested that the nature of a bipropellant explosion is primarily the result of "poor" mixing (on a molecular scale) of the bipropellant fuel and oxidizer, and that turbulence created by the "detonation" disrupts further mixing and extinguishes the "detonation". In liquid explosives, by way of contrast, the "oxidizer" and "fuel" are generally contained within the same molecule and there is no mechanism for extinguishing detonation (Ref 26)

Combustion instability in LP results from pressure oscillations during combustion. If these oscillations are of low frequency, e.g., as a consequence of fluctuations in the propellant flow rate, the resulting instability is called chugging. At high oscillation frequencies, leading to what is sometimes referred to as screaming, longitudinal waves are set up in the combustion chamber as well as cylindrical wave motion. Above a critical amplitude, these cylindrical motions can increase enormously and damage the chamber

Levine (Ref 22, p 1083) has studied high frequency combustion instability of LP via high speed

photography and pressure-time measurements. Crocco has examined these phenomena theoretically (Ref 22, p 1101). Bernard & Dufour (Ref

16, p 1074) make the interesting suggestion that instability in amine/nitric acid bipropellants is associated with the production of intermediates, such as amine-nitrates, which decompose explosively on rapid temp and pressure rises

The compatibility of LP with materials that they may contact can create hazard problems. Hollister (Ref 19) reviews the compatibility of several LP systems in contact with elastomeric materials

Farber (Ref 31) points out that LP rocket destruct systems (specifically Saturn V) can initiate dangerous secondary explosions in the discharged fuel/oxidant mixture

Specific tests of the detonation sensitivity of LP are not very different from those used with liquid explosives, but the interpretation of LP sensitivity tests is subject to large uncertainties. This is so, because practical considerations dictate that relatively small amounts of LP be tested, but for many LP systems the increase in sensitivity with increasing test sample amount is not known

Tannenbaum & Beardell (Ref 30, p 344) suggest the following "routine" tests:

- a) A modified Trauzl lead block test (See Vol 1 under Physical Tests) with a 0.5 to 2g LP sample and a No 8 blasting cap initiator;
- b) Bureau of Mines drop-weight test;
- c) Adiabatic compression test in which a piston rapidly compresses a gas bubble above the test liquid;
- d) Self-heating test in which the sample is heated in a bomb and the sample and heating bath temps are monitored;
- e) Card-gap test (See Vol 1 under Physical Tests to test shock-sensitivity); and
- f) Critical diameter established by measuring detonation velocity in columns of decreasing diameter

Glatts (Ref 20) tested four monopropellants for sensitivity to fire and bullet impact. Hydrazine, Hydrazine Nitrate solution, PrNO_3 , and ethylene oxide were all tested in 1-gallon aluminum containers (half of them filled to 25% and half to 95% capacity) by being subjected to oil and wood bonfires, and 20-mm incendiary, 20-mm HE incendiary, and 0.30-caliber rifle fire. Aviation gasoline was tested in the same manner. In the bonfire tests, all four monopropellants generally gave equivalent explosion intensities regardless of the type of bonfire or the amount of liquid in the test container. Occasionally, however, with the first 3 monopropellants, anomalous re-

sults occurred: there was either no explosion or an explosion of above average intensity. Ethylene oxide more nearly approximated the behavior of aviation gasoline than did the other monopropellants. In the rifle-fire tests, PrNO_3 was the most bullet-sensitive. It was exploded by all three types of ammunition. Hydrazine and Hydrazine Nitrate solution were exploded by the HE ammunition but not by incendiary and HE incendiary ammunition

Written by **J. ROTH**

Refs: 1) K.E. Ziolkowsky, Science Survey Russ) (1903) 2) R. Esnault-Pelterie, Soc-Astronomique de France, Paris (1928) 3) R.H. Goddard, Smithsonian Inst Misc Collections **95** (3) (1936) 4) F.J. Malina, JFranklinInst **230**, 433 (1940) 5) M.W. Nesbitt, JAmRocketSoc **68**, 1 (1946) 6) J.H. Wyld, JAmRocketSoc **17** (70), 2 (1947) 7) M.J. Zucrow, "Principles of Jet Propulsion and Gas Turbines", Wiley, NY (1948) 8) R.C. Truax, JAmRocketSoc **18** (74), 62 (1948) 9) G.P. Sutton, "Rocket Propulsion Elements", Wiley, NY (1949) 10) S.S. Penner, JChemEd **29**, 37 (1952) 11) J.B. Goldman, "Liquid Monopropellants and Their Application", General Dynamics/Astronautics Bibliography, San Diego, Calif (1959) 12) O.E. Lancaster, Edit, "Jet Propulsion Engines", Princeton Press, Princeton, NJ (1959), 10-23, 23-26, 439-41, 442, 440-44, 453-64, 464-71 & 475-516 13) S.S. Penner & J. Ducarme, Edits, "The Chemistry of Propellants", Pergamon Press, NY (1960), pp 25-228 14) J. Ducarme et al, "Progress in Combustion Science & Technology", Pergamon Press, NY, Vol **1** (1960), pp 183-217 (Chapt on Ignition in LP Rocket Engines) 15) R.E. Wiech & R.F. Strauss, "Fundamentals of Rocket Propulsion", Reinhold, NY (1960), Chapt 5 16) 8th SympCombstn (1962), pp 1035, 1074 & 1140 17) L.E. Bollinger et al, Edits, "Progress in Astronautics & Rocketry", Academic Press, NY (1960), pp 447 & 471 18) Yu.Kh. Shaulov & M.O. Lerner, "Goreniye v Zhidkostnykh Raketnykh Dvigateliakh" (Combustion in Liquid Rocket Fuel Motors), GosizdatOboronProm, Moscow (1961) 19) W.A. Hollister, USDeptCommOfficeTech-Serv, D275279 (1962) & CA **60**, 10465 (1964)

20) G.S. Glatts, NASA Doc **N62-10432** (1962) & CA **60**, 10465 (1964) 21) E. Ring, "Rocket Propellants and Pressurization Systems", Prentice-Hall, Englewood Cliffs, NJ (1964) 22) 10th SympCombstn (1965), 1083 & 1101 23) T. Urbański, "Chemistry & Technology of Explosives", Pergamon Press, NY, Vol **3** (1967), pp 291-321 24) J.P. Hanley, "Advanced Solid and Monoliquid Gas Generators", Report **RMD 6055-3**, Thiokol Chemical Corp, Reaction Motors Div, Denville, NJ (1968) 25) R.K. Lund, "Encapsulated Liquid Monopropellant Ammunition Feasibility Study", Eglin AFB Tech Rept **AFATL-TR-61-27** by Thiokol Chemical Corp, Wasatch Division, Brigham City, Utah (1968) 26) R.F. Fletcher, Ann-NYAcadSci **152** (1), 432 (1968) & CA **70**, 69711 (1969) 27) M.V. Dobrovolskii, "Zhidokosnye Raketnye Dvigateli" (Liquid Rocket Propellants), Mashinostroenie, Moscow (1968) & CA **71**, 126715 (1969) 28) J.N. Bradley, "Flame & Combustion Phenomena", Methuen & Co Ltd, London (1969), pp 163-7 29) R.F. Gould, Edit, "Propellant Manufacture Hazards & Testing", Advances in Chemistry, Series **88**, American Chemical Society, Washington, DC (1969), pp 312 & 344 31) E.A. Farber, EngProgrUnivFlaTechPapSer **1969**, p 448 & CA **72**, 45640 (1970) 32) Anon, EncyclBrittanica **18**, 629 (1971) 33) Anon, "Monopropellant Hydrazine Propulsion Systems", Chemical Propulsion Information Agency Publication **228** (IV), JANNAF Propulsion Meeting, New Orleans, La (1972) 34) M.J. Russi, "A Survey of Monopropellant Hydrazine Thruster Technology", Aerospace Corp, San Bernardino, Calif (1974) 35) R. Meetin & J. Newton, Final Rept Proj AF-3058, Edwards AFB, Calif (1974)

Liquid TNT. See under Drip Oil in Encycl **5**, (1972), D1546-R to D1547-L

Litharge. See Lead Monoxide in this Vol

Lithium-Aluminum Hydride. See Aluminum-Lithium Hydride in Encycl **1**, (1960), A154-R to A155-L, and under Hydrides in this Vol

Lithium Nitrate. LiNO_3 , mw 68.95, colorless delq granules, mp 261° , d 2.38g/cc; sol in w and alc. Used in pyrotechnics as an oxidizer to color burning compns red (Ref 2), and in rocket proplnts (Ref 1a)

Refs: 1) Gmelin, Syst Nr 20 (1927), 98ff 1a) D.R. Stern, USP 2949006 (1960) & CA 55, 4964 (1961) 2) EngDesHdbk, "Properties of Materials Used In Pyrotechnic Compositions", AMCP 706-187 (Oct 1963), 179-80 3) CondChemDict (1971), 525-L

Lithium Perchlorate. LiClO_4 , mw 106.40, colorless delq crystals, mp 236° , d 2.429g/cc; sol in w and alc. Decompn starts at about 400° and becomes rapid at 430° , yielding LiCl and O_2 . It has more available O_2 on a vol basis than liq O_2 , and is thus used in "oxygen candles" (Ref 2, p 237). It is used as an oxidizer in solid rocket proplnts and in pyrotechnics to color burning compns red (Refs 1 & 2)

Refs: 1) EngDesHdbk, "Properties of Materials Used in Pyrotechnic Compositions", AMCP 706-187 (Oct 1963), 181-2 2) Ellem (1968), 124, 237, 271 & 337 3) CondChemDict (1971), 525-L

Lithoclastites. Dynamites patented in Fr by Roca in 1884 contd NG mixed with hydrocarbons and other substances

Ref: Daniel (1902), 690

Lithofracteur. Brit mining expl manufd between 1882 and 1899. Its approx compn was NG 54, Ba nitrate 15, kieselguhr 17, wood flour 2, bran 1, sulfur 4, Mn dioxide 2 & soda ash 2% (Refs 1 & 3). A Ger version, called *Lithofracteur Krebs*, contd NG 52, pulverized coal 12, sulfur 2, Na nitrate 4 & kieselguhr 30% (Ref 4). Gody (Ref 2) lists a *Lithofracteur Dynamital* which contd saltpeter, sulfur, sawdust and bran. He also lists a *Lithofracteur of Newton*, known as *Poudre Newton*, which consisted of Ba nitrate 77, K nitrate 2 & charcoal 21%

Refs: 1) Daniel (1902), 409 2) Gody (1907), 173 3) CondChemDict (1942), 290 4) Pérez Ara (1945), 331

Lithorite. A Belg mining expl used at the end of the 19th century. It consisted of K nitrate 50.0, Na nitrate 16.0, sulfur 16.0, nitrated sawdust 8.0, Amm picrate 3.5, K ferrocyanide 3.0 & charcoal 3.5%

Ref: Daniel (1902), 410

Little David. An experimental rifled mortar (914mm mortar T1) of 36" diameter developed in the USA during WWII. This mortar and its special ammo were secretly developed for reducing Ger fortifications; however, this proved to be unnecessary. The mortar weighed 172900 lbs; its proj weighed 3650 lbs of which 1589 lbs was HE. It was fired by a max propelling charge of 218 lbs of proplnt, and had a range of about 9000 yards

Ref: J. Quick, "Dictionary of Weapons and Military Terms", McGraw-Hill, NY (1973), 279

Livens Projector. Invented during WWI by Capt J. Livens of the Brit Army. It was a crude form of a trench mortar, consisting of a smooth bore tube (8" ID, 37.5" long) which was used to project *Livens Drums* by means of a proplnt charge ignited by an electric primer. The drums were ellipsoidal-like containers (7-5/8" diam, 20" long) filled with either gaseous agents or incendiary materials, and contained a burster charge. The filled drum weight was about 61 lbs, and its range was between 910 and 1450 yards.

From 400 to 800 projectors were covertly installed in a specially prepd trench, whose front wall was cut at a 45° angle. Their only mounting was a simple metal base placed to prevent the tube from being driven into the ground on discharge. The projectors were held in place by earth filling. They were electrically connected in sets of 25, and on firing of 800 projectors simultaneously, a charge of 11 tons of phosgene gas would be deposited over 50 to 100 square yard area without preliminary warning to the enemy

Refs: 1) Anon, "History of Trench Warfare Materiel", ArmyOrdnHandbook No 154, US-GovtPrintingOffice, Washington (1920), 170-81 2) A.B. Ray, IEC 13, 716-17 (1921) 3) C. Wachtel, "Chemical Warfare", Chemical

Publishing Co, Brooklyn, NY (1941), 288
4) Anon, "Livens Projector", US War Dept
Tech Manual TM 3-325 (1942)

LOADING AND FABRICATION OF EXPLOSIVES

Process Selection.

Most solid high expls are manufd by processes that yield granular material. Their bulk densities are generally somewhat less than 1 g/cu cm. They are used in military applications as solids of well defined configurations, usually at densities between 1.5 and 1.7g/cu cm

The two principal loading techniques are casting and pressing. All expls in common military use can be pressed, however, those that are castable are usually cast because of the greater convenience and flexibility of this process. As a rule of thumb, main bursting charges of large cal munitions are cast while small explosive components (initiators to boosters) are pressed

More pounds of military expl are cast than are loaded by all other processes. Essentially, the casting of an expl involves only melting it and pouring it into a charge case or mold. In practice, like most fundamentally simple processes, the procedures necessary to cast charges of the quality needed for acceptable performance and safety can become quite elaborate. A suitable pour viscosity is of over-riding importance

The most common procedure for pressing powd expls is that of pouring the powd into a mold and pressing it with a ram that fits snugly. The pressure most frequently specified for charges used in military items is 10000 psi. Charges may be pressed directly into their containers or pressed into molds and ejected as pellets. Where they are pressed into containers of lengths greater than the diameter, the explosive is usually loaded in increments

After pressing or casting, it is sometimes necessary to machine explosives, either to provide a smooth surface or a fuze cavity at the filling hole, or to produce complex contours required for some specialized purposes. In some cases, mating contours of two charges are cemented together. Cavities are also formed using a special tool on final pressing

Of increasing importance are the plastic

bonded expls (PBX). These are exactly what the name implies, and like plastics can be obtained in many different forms. Hence, PBX's are available for casting, pressing, or extruding. They vary from rigid to rubbery consistencies depending on the type of plastic used as the binders - thermoplastic or thermosetting - and the degree of polymerization permitted. High mechanical strength and high thermal stability are possible (Ref 10)

Other considerations for process selection include fabrication facilities and suitability of the explosive for its intended application (Ref 13)

Casting.

Projectile Preparation

As part of the manufg process, the interior wall of the proj is sprayed with paint or varnish, primarily to prevent rusting of the proj in storage. The requirements of the coating are that it be compatible with the expl, adhere well to the proj wall, and offer a good bonding surface for the expl. The latter requirement is necessary to prevent rotation of the charge relative to the spinning proj. The finished coating at the base of the proj should be thin enough to assure thorough drying and be sufficiently smooth to eliminate irregularities that could otherwise form air pockets

The molten expl is usually poured thru a funnel-former. This tool is specially designed to furnish the desired surface contour upon removal and to hold a sufficient reservoir of molten expl to replenish the shrinking, cooling mass beneath it. A thin film of silicone grease is applied sometimes to the former to aid in its release when the expl has solidified

Effect of Casting Procedure On Charge

Characteristics.

1) Porosity and Cavitation.

The porosity of an expl charge is usually introduced by two principal causes, entrained air bubbles and dissolved gases, and shrinkage that occurs as the charge solidifies and cools. The higher the temp of casting and the more fluid the melt, the larger is the fraction of the entrained air that forms into bubbles and floats out of the charge. On the other hand, these conditions maximize cavitation due to shrinkage. The most serious effect of shrinkage is that known to metal founders as "piping".

The casting solidifies from the outside and consequent shrinkage is that of an isolated mass at the center where no additional material is available to fill the volume left by the shrinkage. The result is a single large void at the center of the casting.

In a cast charge (unlike in a pressed charge), both density and pore or cavity size are determined by the casting procedure. Both of these factors must be considered by the designer in terms of their effects upon safety, reliability, and performance.

2) *Crystal Size*

The crystals of TNT in cast expls may vary from microscopic size to a substantial fraction of the size of the charge, depending upon casting conditions and procedure. The approach known as cream casting results in very fine crystals. In mixed expls, which usually are cast in the form of slurries, the solid particles tend to inhibit crystal growth, although TNT crystals sometimes apparently grow around the particles of the slurry. The effects of particle size on initiation sensitivity, failure diameter, and performance characteristics also have been observed to apply to crystal size in cast TNT.

3) *Uniformity of Composition.*

Most castable expls are poured as slurries of RDX, Al, etc, in molten TNT. The instant a charge is poured, the particles of higher density than TNT start to settle, and those that are lighter start to rise. As a result, by the time the material solidifies, its compn varies from point to point within the charge. Another cause of nonuniformity of compn is the tendency of TNT to form essentially pure crystals, leaving other components of the mixt at grain boundaries and in the center of the charge that usually solidifies last. The most serious production problem of this kind is the settling of Al in larger charges of aluminized expls. The use of Al and other additives in very fine particle sizes can help to alleviate this problem but also tends to increase pouring difficulties because of the higher viscosities of the melts.

Standard Casting Procedure

The most common procedure for filling a proj or bomb case is to do so in a single pouring (Ref 7). In loading projs, a funnel or sprue provides a reservoir of molten expl to fill the volume left by the shrinkage. The expl in the funnel

must, of course, remain liq and in communication with the center of the charge. When the filling hole is large enough, convective heat transfer maintains such conditions. In other instances, however, such conditions can be maintained only by means of steam heated funnels, steam finger, or hot probes.

Where the maintenance of a clear channel between sprue and the slowest freezing part of a charge is impractical, cavitation is avoided by casting charges in layers, each of which is allowed to "crust over" before pouring the next.

TNT melts at 81°. It forms eutectics with RDX, Tetryl (68°), PETN (76°), and other "impurities" in the mix and makes these materials more soluble at higher temps. Thus, there is a general tendency for the solid content and, hence, the apparent viscosity of most castable mixts to decrease as the temp is increased. However, a reversal of the tendency toward the reduction in viscosity has been noted in Comp B when it heated above 100°.

From the eutectic or mp, the composition of the liq portion and its viscosity vary as heat is removed. It has been recommended that the heat content of any expl be reduced, before pouring, to the minimum compatible with the avoidance of air entrainment.

TNT may be cast after it has cooled to a point where a fairly large fraction of it has solidified to form a slurry of very small crystals. Such a slurry is obtained by stirring it as it cools. TNT cast in this manner is labeled by some as creamed TNT. Some have applied the term creamed to all expls that are cast after stirring until the last possible instant. Extreme caution must be taken to avoid air entrapment during stirring. This technique has the advantage of resulting in less shrinkage on cooling and solidification because a large portion of the TNT is already solid before casting.

Some Special Casting Techniques.

1) *Pellet Casting.*

For very large charges, cooling time is reduced and shrinkage minimized by use of pre-cast pellets. The best pellet casting technique is that of pouring a quantity of molten expl into the case, and then pouring in pellets, slowly enough so that they are not in contact with one another to avoid entrapping interstitial air (Ref 7). Although pellet casting

reduces the total amount of shrinkage voids, it makes it nearly impossible to maintain channels to the pockets of molten material. The most important advantages of pellet casting is the reduction of cooling time and minimizing of shrinkage in large charges. Pellet casting is not used in loading artillery projs because of the development of cavities

2) Vacuum Melting and Casting.

Entrainment of air may be avoided by melting and casting under a vacuum. Vacuum melting is a fairly straight-forward procedure in the vacuum kettles that are maintained by many loading facilities. Vacuum casting requires specially designed molds or a vacuum chamber large enough to contain both kettle and mold. The definite increase in the cast density should indicate without question the advantage of vacuum melting, namely, an increase in viscosity of the vacuum melted material. Nevertheless, a divergence of opinion exists regarding the value of vacuum melting followed by pouring in air. Some investigators report results nearly as good as those obtained with complete vacuum melting and casting. Others maintain that so much air is entrained in the casting process that the value of vacuum melting is negligible. A possible explanation for this difference of opinion is the difference in techniques that can be applied in various types of operation

3) Vibration, Jolting and Centrifugal Casting.

Accelerating of a cast charge after pouring but before solidification will often expedite the movement of air bubbles to the surface (Ref 4). Vibration and jolting often break the surface tension that causes bubbles to cling to surfaces (Ref 7). Centrifugal acceleration, of course, also accelerates the settling of denser components of mixtures (Ref 7). This has been used to advantage in loading HEAT ammo where it is desirable to have a richer composition of the more energetic compounds (RDX and HMX) around the cone in cyclotol or octols

4) Controlled Cooling.

If an expl charge can be induced to cool from the bottom up, maintaining a nearly plane interface between liq and solid, densities well in excess of 99% of maximum theoretical are attainable. In a complicated programmed cooling, the thermal cycle of preheating

the mold, pouring, and cooling takes over forty hours (Ref 2). At the other extreme is the use of strategically placed insulation to cause a charge to cool in the approximate desired pattern

5) Extrusion

Extrusion may be considered a form of casting under pressure. In applications where cylindrical charges are required, some plastic bonded explosives can be extruded into the desired shape and then placed or pressed into the ammunition housing. Conventional extrusion tools are employed for this process

6) Liquid Explosives

From the standpoint of casting, the pouring of liq or slurry expls is handled in the same manner as that of molten expls. The process is simpler in that pouring takes place at ambient temp. However, care must still be taken to avoid entrapment of air. Liq filling can be speeded up by pumping. If slurries are to be gelled in the ammo, the gelling agent is introduced just ahead of the cavity (Ref 12)

Pressing.

Standard Procedures.

1) Measurement of Explosive Charges

For small test quantities or for some premium quality production, direct reading one-pan balances are used. They are faster than analytical balances and provide an accuracy within one percent. Automatic weighing machines are also available

The desire is always to load a specific weight of expl. This objective can be achieved to a sufficient degree of accuracy for many purposes by volumetric control, as in commercial blasting caps and squibs. The two most common volumetric measuring devices are scoops and charging plates. Scoops (Fig 1)

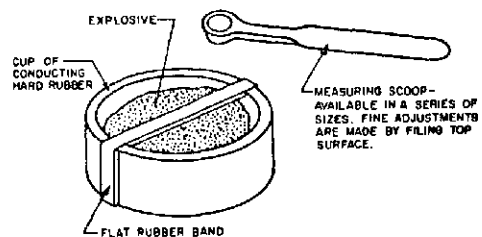

Fig 1 Scoop Loading

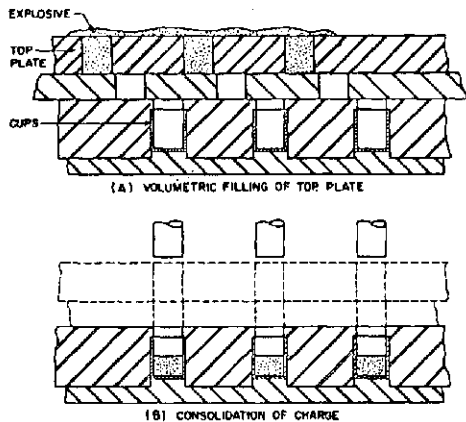

Fig 2 Charging Plate Loading

are filled and leveled against a rubber band. Careful scooping is accurate within 4%. Charging plates (Fig 2) lend themselves to production rates. After filling holes in the top plate and scraping off the excess, plates are aligned with cup holes. Since expl quantities are usually specified by weight, it is left to the loading plant to adjust the volume measured so as to take into account bulk density. There are now several automatic volumetric loading devices for production loading of primer mixes and lead azide used in initiators

2) Direct Pressing in Case

A large proportion of expl charges are loaded by direct pressing of expl charges in cases (Fig 3). Fits and tolerances of expl charge cases and loading tools are determined by reconciliation of three opposing factors: 1) production costs of components rise sharply as tolerances are reduced; 2) powdered expls tend to flow into the clearance between ram and case. In addition to creating a hazard, the expls wedged in this space can increase the frictional resistance to ram movement, and substantially decrease real loading press; and 3) interference between ram and case results in binding (which may be so severe as to prevent any pressing of the expl), damage to the case, inclusion of chips of case material in the expl, or all of these (Ref 1)

The cost of a set of loading tools may be distributed over a large number of items. For this reason, they are often made to fits and to-

lerances similar to those used for gages. Where cases are made by processes such as forging, drawing, and extrusion, which use most of the tolerance in lot-to-lot variation, some loading activities have found it worthwhile to maintain a series of loading tools of graduated dimension, using those giving the best fit possible with each lot of cases

Production loading tools should be hardened (60 Rockwell C is common). The die should be ground, honed, and lapped or polished to an 8 or 16 rms micro-inch finish. Some claim better results if the final operation involves longitudinal rather than rotary motion

The friction between the expl and the walls causes a gradient of press, and hence density, decreasing from the face of the ram. The slope of this press gradient, of course, is proportional to the coeff of friction between the expl and the walls, which varies with both expl and case material and also with the interior finish of the case. As a general rule, the density variations due to these gradients are kept within reasonable bounds by adherence to the general

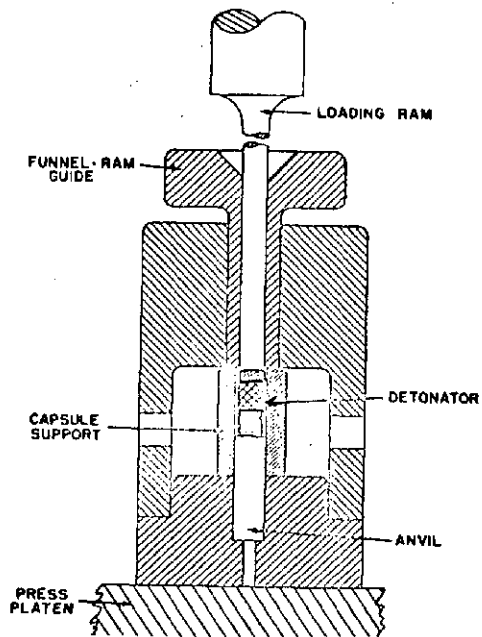

Fig 3 Detonator Loading Tool

rule-of-thumb that the length of an increment after consolidation should not exceed the diameter of the cavity (Ref 2)

The usual loading press of about 10000 psi is well beyond the bursting strength of charge cups of any material that can be economically deep drawn. Hence, cups are supported by close fitting loading tools while being pressed. Most of the difference between the cup diameter before and after loading is accounted for by the expansion of the expl component, relieving residual stresses, as it is pushed out of the tool. For this reason, loading tools should be made to fit the maximum outside diameter of the cup, within a few ten-thousandths of an inch. Standard dimensions and tolerances of cups are listed in MIL-STD-320 (Ref 11). Bore finish and hardness of the bushing are important factors in trouble-free ejection of finished cups. Lapped or honed bores are often specified. Where cases are heavier or where expls are to be loaded directly into fuze cavities, the interactions of case and tool tolerances, which may be sufficient to cause interference between the ram and any of the bores thru which it passes, should be considered carefully. In some situations, where expls are to be loaded directly into fuze holes, the most practical way to attain alignment is to use a pin or dowel, similar to the loading ram, to hold the component in alignment with the ram guide while it is being clamped in place. It is best to use an alignment pin a thousandth of an inch or so larger than the loading ram. Fig 4 shows a set-up for hand loading of leads making use of an alignment ram and a mandrel

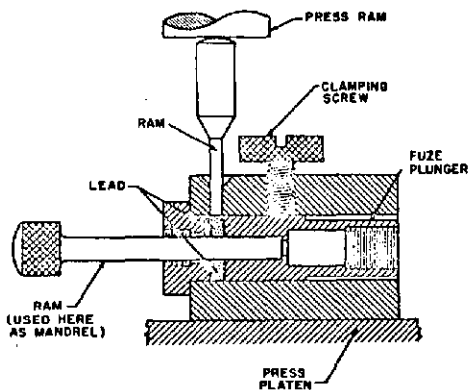

Fig 4 Tool for Direct Loading of Component

3) Stop vs Pressure Loading

In production, it is possible either to press a controlled quantity of expl to a controlled height (called stop loading) or to apply a given load to a loading ram of a given diameter (called pressure loading). The inherent variations in production material introduce a certain amount of error in the density obtained by either method

The relationship between loading press and charge density for commonly pressed expls is given in Table 1 (Ref 1). An approximation of the loading densities of six commonly used explosives is shown in the nomograph, Fig 5 (Ref 3). The pressure-density relationship varies somewhat from lot to lot. In addition, loading density is affected by such factors as ram clearance and increment length

From the usual cup tolerances, it has been calculated that the cross-sectional area of the expl column of a detonator may vary by two or three percent. In normal production, a reasonable weighting tolerance for initiator charges is three or four percent. Thus, in stop loading, assuming that the height of an increment is exactly reproduced, the density may vary as much as seven percent

The implication of the foregoing, that densities are more readily controlled by the control of loading pressure than by stop loading, has been borne out by experience. However, the production advantages of stop loading are sufficient to outweigh any theoretical disadvantages. It is important for stop loading to specify dimensions, quantities, and tolerances such that the max press is within limits imposed by tool strength. When items so loaded are used, safety and reliability determinations should take the effects of variable charge density into account. In either type of loading, a check of the loading density for each production lot is highly desirable

When density is determined by pressure loading, variation in press, cross-sectional area, and charge weight each has an effect upon the column-height. Usually, the length tolerances specified cannot be held merely by holding the various quantities mentioned within their tolerances. The weight of expl must be adjusted to compensate for the other variables. Commonly, the last charge loaded is adjusted to fit the space

TABLE 1

LOADING DENSITY OF VARIOUS EXPLOSIVES

Explosive	Pressed (pressure kpsi)						Cast	Crystal Density
	3	5	10	12	15	20		
Composition A-3	1.47	—	1.61	1.65	—	—	—	—
Composition B	—	—	1.59	—	—	—	1.67	—
Cyclonite (RDX)	1.46	1.52	1.60	1.63	1.65	1.68	—	1.82
EDNA (Haleite)	—	1.39	1.46	—	1.51	1.55	—	1.71
Explosive D	1.33	1.41	1.47	1.49	1.61	1.64	—	1.72
Lead Azide	2.46	2.69	2.98	3.05	3.16	3.28	—	4.68
(2 specimens)	2.62	2.71	2.96	—	3.07	—	—	—
Lead Styphnate (Norm.)	2.12	2.23	2.43	2.47	2.57	2.63	—	3.1
Pentolite, 50-50	—	—	1.59	—	—	—	1.65	—
PETN	—	1.48	1.61	—	—	—	—	1.76
Picric Acid	1.4	1.5	1.57	1.59	1.61	1.64	1.71	1.76
Picratol, 52/48	—	—	—	—	—	—	1.62	—
Tetracene	1.05	1.22	1.33	1.37	1.41	1.48	—	4.72
Tetryl	1.40	1.47	1.57	1.60	1.63	1.67	—	1.73
TNT	1.34	1.40	1.47	1.49	1.52	1.55	1.59	1.65

(Densities are in g/cc)

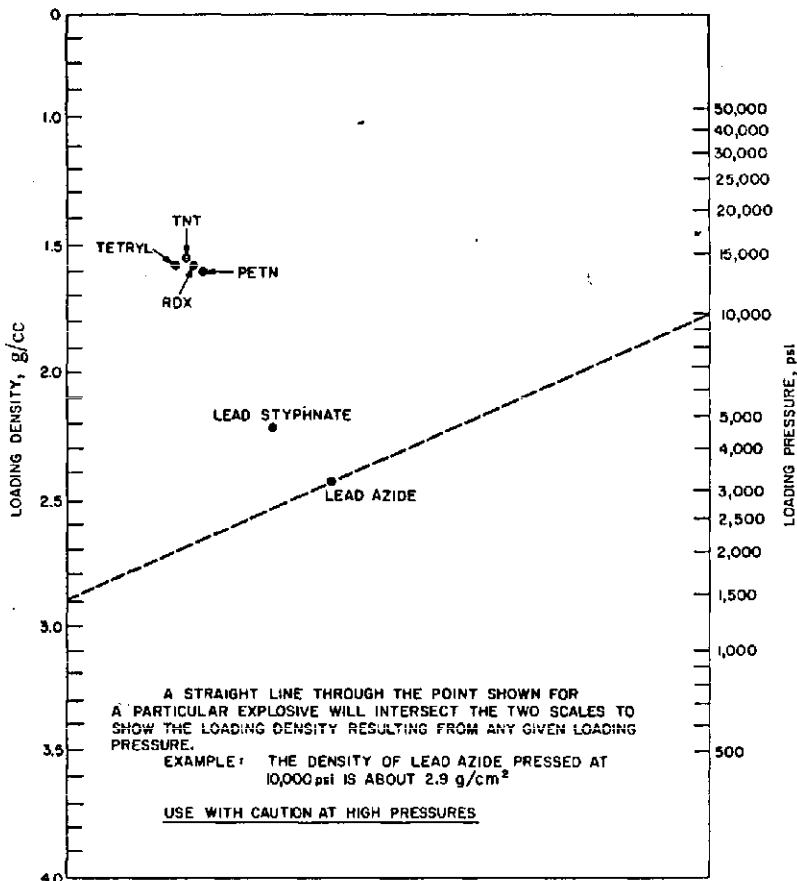

Fig 5 Nomograph of Loading Pressure and Density

remaining for it and the weight is specified as "approximate"

In addition to the pressing properties of the expl as such, the relationship between loading press and density is affected by such factors as ram movement, clearances, increment size, and the coeff of friction between expl and case. The movement of the ram affects the relationship in two ways

The first effect may be very serious. Where a balance or dead weight is used to determine the loading press, a rapid ram movement can result in a force due to acceleration of the masses moved which may vary from a substantial fraction to several times the force due to gravity. Analyses of some loading operations have revealed that the true loading press was three or four times that intended

The second effect of ram movement usually works in the opposite direction (slower ram speeds plus a dwell at the peak press may cause an increase in density). This effect is due to the fact that, at loading pressures usually used, expls are stressed beyond their yield points and creep or flow plastically. This effect, of course, becomes more important at very high pressures, such as those used for delays. In addition to increasing the density, slower speeds plus dwell of the ram result in a more uniform density

4) Pelletizing

Most powdered expls that are to be pressed are prepressed into pellets. The die of the loading tool permits closer tolerances and better finishes than are reasonable for cases that are loaded by direct pressing. Exceptions are primer mixes, PETN, and LA, although LA is pelleted in Canada on a production basis

Although pellets for expl use are loaded by single operation methods in which weighed charges are pressed either by stop loading or by controlled pressure techniques, quantity production of pellets is accomplished in automatic pelleting machinery, in which the explosive is metered volumetrically by the controlled movements of punches. Single stroke presses of the types used for expls produce about 90 pellets per minute while rotary presses have rates of about 700 pellets per minute

The density gradient resulting from wall friction, in addition to its effects on expl per-

formance, may adversely affect the handling properties of pellets. Pellets consolidated from powders at low densities tend to be weak in two ways; their resistance to body fractures is often less than desirable, and they may crumble at corners and chalk off at surfaces. On the other hand, some materials become brittle and develop residual strains at high densities

The effect of density variation on mechanical properties of pellets may cause difficulties even though the variation in expl properties is tolerable. On the other hand, the general superiority of the finishes of pelleting molds over those of charge cases and the use of double acting loading equipment result in somewhat smaller density gradients in pellets than in direct loaded explosives. The result of these counterbalancing trends is that the one-to-one limiting ratio of length to diameter which applies to increment loading also applies to pellets. For some materials, somewhat shorter pellets are desirable, particularly in larger sizes

The diameter of a pelleting die may be maintained to almost any tolerance specified. Similarly, the distance between the top and bottom punches of an automatic pelleting machine, or the punch-to-heel distance in a stop pressing tool, can be held to any desired tolerance. Thus, the dimensional variations are essentially the variations in expansion of the material, during and after ejection from the die. The immediate expansion upon ejection for a typical expl used for pressed pellets is about 0.3%. Pellet-to-pellet variations are usually less than 0.1% but the expansion continues with storage at a rate that varies appreciably with conditions as well as with the compn of the expl. Pellets of an expl of known expansion characteristics, which are to be inserted into cups within a few hours after pelleting, may be held to dimensional tolerances of the order of 0.1% or less. However, tolerances of 0.3 to 0.5% are more practical

Variations in density reflect variations in dimensions with those of the bulk density and flow characteristics of the expl, and those of the measured volume. With frequent pellet density determinations and occasional adjustment of the pelleting press, expls with good flow properties can be pressed into pellets reproducible in density to 1% in an automatic pelleting press

5) Reconsolidation

Frequently, when it is desirable to attain the close confinement and continuity characteristic of expls loaded directly into their cases, it is difficult or inconvenient to do so. In such instances, pellets are inserted into the cavities and reconsolidated by pressing. In designing for reconsolidation, consideration must be given to the tolerances and variations of hole dimensions, pellet weight, and pressure-density relationship that enter into the determination of the relative location of the surface thru which the reconsolidation pressure is applied. Where this dimension is critical, the reconsolidation is done to a stop so that the tolerances appear in the density of the reconsolidated pellet. When reconsolidation is specified, the effects of these variations upon performance should be considered

Special Procedures

1) Vacuum Pressing

In the usual pressing operation, in which a granular expl is pressed from a bulk density of about half the crystal density to about 95% of the crystal density, the press rise in the interstitial gases (assuming isothermal compression and no leakage) may be in the neighborhood of 200 psi. The air may be presumed to diffuse out of the pellet, thru the continuous pores, quite rapidly after the pellet is ejected or the ram is removed, if it has not already leaked thru the clearance between ram and cavity during pressing

When densities reach 99% of cryst density, the calcd press of the interstitial gases rises rapidly, limiting attainable densities. When under conditions of pressing, the expl or some component of it is caused to flow plastically, the pores may be closed into individual bubbles in which the compressed gases are retained to cause excessive growth after press removal or pellets that pop open when ejected from the die. In an open pore material, the relatively mobile gases tend to increase density gradients by distributing press without a correspondingly even distribution of the solid expl. For these three reasons, vacuum pressing is used where very high or uniform densities are required, or where significant plastic flow is anticipated

during pressing

Fig 6 is a diagram of a vacuum loading tool. First, lower and top punches are advanced to a prepress position to compact the powder slightly. After evacuating to 1 mm Hg, full press is applied. Production of extremely high quality charges of TNT (pressed at elevated temp) and Composition A-3 (both at elevated and room temp) has been reported. Density spreads within 6-in diameter charges are 0.005g/cc (Ref 2)

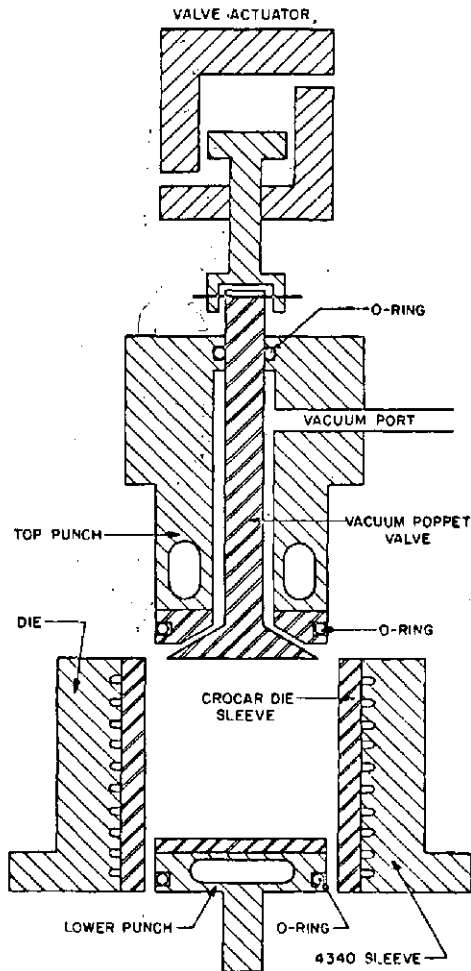

Fig 6 Vacuum Pressing Apparatus

2) Hot Pressing

The unique props of plastic bonded expls are realized most fully if they are pressed at elevated temps. Appropriate temps, of course, are detd by the props of the plastic bonding agents used and limited by the thermal instability of the expls. Temps as high as 130° have been used (Ref 9). When heated to temps approaching their melting points, expls and additives used in expls, like most solids, are more prone to plastic flow. Equipment required for hot pressing of PBX has been found useful in the production of high density charges of conventional expls. TNT is pressed routinely to a density of 1.62g/cc at 70° in the vacuum pressing process previously described, whereas cast densities this high are unusual (Ref 2). Pre-heating of the expl is more efficient than waiting for it to heat in the mold but cannot be used when thermosetting resins serve as binder

3) Hydrostatic and Isostatic Pressing

When an expl is pressed in a die by means of a ram, the friction of the walls tends to cause press and density gradients. In addition, the one-dimensional compression can result in an anisotropic structure and produce pellets with residual strains. Where dimensional stability, uniformity and high density are essential to performance, hydrostatic pressing and isostatic pressing have been used. In both of these processes, the expl is compressed by the action of a fluid, from which it is separated by a rubber (or other elastomer) film

In hydrostatic pressing, the expl is placed on a solid surface and covered with a rubber diaphragm (Fig 7). Although this process elimi-

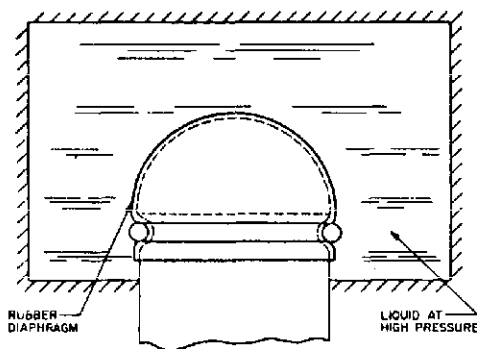

Fig 7 Hydrostatic Press Principle

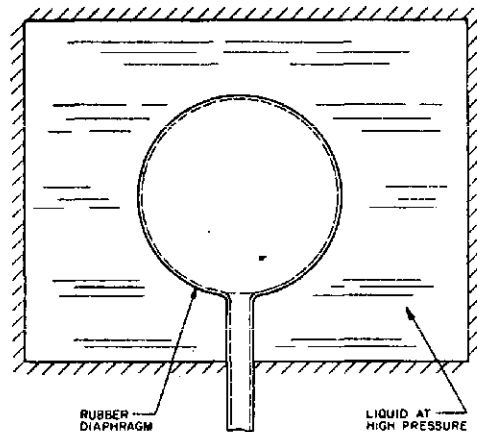

Fig 8 Isostatic Press Principle

nates the gradients which result from wall friction, some directionality of compression remains which can result in anisotropic structure and residual strains. In isostatic pressing, the explosive is placed in a rubber bag (Fig 8) that is surrounded by the pressurizing fluid so that the compression is essentially three-dimensional

In addition to the production of high quality charges, hydrostatic pressing and isostatic pressing can be used to consolidate expls which are so sensitive that frictional contact with the walls of a conventional mold creates a hazard. Materials like pure RDX, of which it is difficult to make firm pellets except in small sizes, can often be pressed hydrostatically or isostatically (Ref 9)

Hydrostatic pressing and isostatic pressing are usually applied to expls that have been evacuated, frequently at elevated temps. Temps up to 130° and pressures up to 30000 psi have been used. The surfaces where pressure is applied thru elastic membranes are, of course, of relatively poorly defined form and dimensions. Hence, these pressing processes must almost invariably be followed by machining

4) Pulsating Pressures

Expts have shown that pressures which pulsate with an amplitude of a few percent of the static press and at a frequency of about 60 Hz, when used with conventional molding tools, make it possible to produce pellets four or five diameters long with negligible density gradients. The interesting possibilities of this technique in production of explosive charges have not yet been exploited

Finishing Operations

1) Machining

It has been found that the most uniform densities and compositions are attained by pressing or casting relatively large charges, and machining the charges needed from selected segments. Similarly, high quality charges can be made by isostatic or hydrostatic pressing, which also must be followed by machining operations. All standard machine shop operations including milling, drilling, sawing, boring, and turning — are applied in this work

Many cast loaded items are filled thru the same hole as that into which the fuze is to be inserted. After casting, the sprue is broken off. Although it is a good plan to design the funnel to form a core for the fuze cavity, the problem of funnel extraction limits this practice to some extent. At best, then, the bottom of the fuze cavity is a rough, broken off surface and, generally, the cavity is not as deep as desired. The boring of fuze cavities to the specified depth and surface finish is a routine operation of production

Profile lathes and forming tools may be used to form almost any desired surface of revolution. The special forms required for detonation wave shaping and other specialized output are often generated by such means. Expls may be machined to the same tolerances as metals. Turning and milling to a thousandth of an inch is not difficult with a good machine. However, the practical applicability of such precision is limited by the dimensional instability of most expl materials

Safety is an important aspect in machining explosives. Since the sensitivity of an expl has meaning only in terms of the specific initiating impulse, the practice of machining each expl material by remote control is most desirable (Ref 2). On the basis of test data it is considered safe to machine Composition A-3, Composition B, and TNT at 200 ft/min surface speed

Cut-off tools and small drills are more hazardous because of the poor cooling conditions. These operations, if necessary, should be performed at low speeds with intermittent cutting and frequent flushing. Water should be used wherever practical as a coolant, although tests at high speed under dry conditions are

considered justification for dry machining where needed. The water keeps expl dust out of the air and cools the cutting operation

2) Cementing of Compound Charges

Expl charges made of more than one expl, in which the contour of the boundary is an important design parameter, often are fabricated from cast, pressed, or machined components that are cemented together

Cements that harden by the loss of solvent generally are to be avoided because the solvent can be lost only by diffusion thru the expl. Diffusion may be slow and the solvent may modify the properties of the expl. Two types of cement that have been used for this purpose are catalytic setting cements, like epoxy resins, and contact cements. Compatibility of the materials to be used should be checked. Compatibility of epoxy resins with most explosives depends upon the catalyst or hardener used (Ref 8). Data regarding bond strengths and other pertinent properties also have been compiled (Refs 5 & 6)

Both surfaces to be cemented should be clean and fit accurately to one another. A minimum continuous layer of cement should be applied to each surface to be joined. Where catalytic resins are used, provision should be made to hold the members in firm contact for the curing period. When contact cements are used, mechanical means are desirable to assure that the elements are in the proper position and orientation when they make the first contact

Written by S. M. KAYE

Refs: 1) Anon, "Ordnance Explosive Train Designers' Handbook", Report NOLR 1111, NOL (April 1952) 2) E. James, Jr, "Charge Preparation for Precise Detonation Studies", 2nd ONR SympDeton, Vol 1 (1955), pp 1-17 3) Anon, "Explosion Effects Data Sheets", NAVORD Rept 2986, NavOrdLab, Silver Spring, Md (June 1955) 4) G.D. Clift, "Centrifugal Casting of Explosive Charges for HEAT Shell", PATR 2381 (1956) 5) M.J. Bodnar, "Bonding of Explosives to Metal with Adhesive", PATR 2412 (1957) 6) M.J. Bodnar, E.R. Kelly and W.J. Powers, "Adhesive Bonding of High Explosives to Metals", PATR 2538 (1958) 7) M.J. Margolin & E.A.

Skettini, "Ammunition Loading Techniques", *ExplsDevSectRept* **43**, PicArns (1958)

8) M.C. St. Cyr, "Compatibility of Explosives with Polymers", *PATR* **2595** (1959) 9) C.C. Misener, "Capabilities of Explosive Loading Group of the Chemical Engineering Division (WE)", *NAVORD Rept* **6873**, NavOrdLab, Silver Spring, Md (April 1960) 10) D. Kite Jr, A.K. Behlert & E. Jercerzewski, "Plastic Bonded Explosives for Use in Ammunition", *PATM* **2-2-62** (1962) 11) Anon, "Terminology Dimensions and Materials of Explosive Components for Use in Fuzes, *MIL-STD-320* (July 1962) 12) S. Levmore, "Principal Characteristics of the Gelled Slurry Explosive DBA-22M", *PATR* **4237** (1971) 13) Anon, *EngDesHdbk*, "Explosive Series—Explosive Trains", *AMCP* **706-179** (Jan 1974), 10-1 to 10-19

Addnt Refs: a) C. Claessen, *GerP* 243981 (1910) (Double-walled steam heated funnel for shell loading with molten expls) b) C.E. Bishel, *GerP* 227635 (1910) (Cast loading of expls under press to increase their d) c) Anon, *GerP* 244034 (1911) (to Deutsche Sprengstoff A-G) (High d is achieved by maintaining a feeding head full of liq expl and subjecting it to press during charge solidification) d) Anon, *GerP* 255096 (1911) (to Dynamit A-G) (A cold rod of HE is introduced into the main axis of a molten charge to increase the rate of cooling, and thus prevent cavity formation) e) W. Fairweather, *BritP* 24960 (1911) (Molten HE is poured into a shell and subjected to mechanical press while the upper part is kept liq by heat, and the lower part is allowed to solidify by cooling with w) f) Anon, *GerP* 279526 (1913) (to Deutsche Sprengstoff A-G) (Cavity-free HE charges of high d are obtained by casting into cases and subjecting them to centrifugal forces) g) Colver (1918), 10, 319; 442-483, 671 (Various methods of obtaining high d casts of HE are reviewed, eg, direct or press casting, chilled molds or shells, cold core expl, and centrifugation) h) Anon, *ChemAge* **1**, 385-6 & 407-8 (1919) & *CA* **13**, 3318 (1919) (Loading of TNT & Amatol by melting and pouring, pouring shaped charges into blocks with subsequent loading into shells, pressing block charges and fitting into shells, stemming, and direct hydraulic pressing) i) C.A. Woodbury,

USP 1329566 (1920) (Loading of shells with a mixt prepd by dissolving PA in TNT and then adding TNX while maintaining the temp of the mixt above the mp of TNT) j) F. Hawkes, *ArOrd* **2**, 208-11 (1922) (Loading of shells with TNT and Amatol) k) J.P. Madden & L. Fisher, *USP* 1420637 (1922) & *CA* **16**, 2993 (1922) (A portion of TNT is melted and then mixed with about 2.5 parts of solid TNT to form a plastic mixt for filling) l) Anon, *BritP* 181030 (1922) & *CA* **16**, 4349 (1922) (To facilitate loading of shells with TNT or like expl under press, part of the TNT is first melted and heated to about 85°, and the remainder is then added dry and well stirred to form a plastic dough, which is forced into the shell) m) W.A. Gibbons, *USP* 1453933 (1923) (Cast loading by partially filling a shell with solid HE, followed by pouring the HE in liq form to fill the cavities) n) G.C. Hale, *ArOrd* **5**, 838-40 (1925) (Ger methods for loading HE shells) o) J.P. Harris, *ArOrd* **7**, 40-8 (1926) (Loading of ammo at PicArns) p) H.H. Olmstead, *USP* 1670689 (1928) & *CA* **22**, 2467 (1928) (Molten expls are poured into shells in successive layers, each about ½" in thickness, and allowed to cool for about 30 minutes before adding the next layer) q) O. Matter, *USP* 1903594 (1933) (A soln of HE is gradually added to a liq in motion which is miscible with the solvent in any proportions, but does not dissolve the expl. The pptd expl is melted to form a fluid mass contg unmelted granules in suspension, and the resulting broth-like mass is cast) r) C.R. Dutton, *ArOrd* **20**, 389-93 (1940) (Filling of bombs with a molten PA/TNT mixt) s) H. Shaler, *USP* 2195429 (1940) & *CA* **34**, 5283 (1940) (Loading of expls into ammo is done by introducing an increment of molten expl, and rotating the ammo on its axis until the increment has solidified. This operation is then repeated with successive expl increments) t) M.A. Cook & C.O. Davis, *USP* 2353147 (1944) (High d HE charges are obtained by heating a mixt of two solid ingredients, one being a nitrated organic compd, to a temp at which one of the compds melts. A dispersing agent is included in the mixt) u) L.A. Quayle, *MechEngrg* **67**, 599-606 (1945) (Volumetric pouring machine for filling mines, bombs &

shells) v) H. Bernstorff & A. Allendörfer, USP 2390052 (1945) (Device for stirring expl melts) w) H. Graham et al, *Canad Chem & Process Indus* **30**, 37-41 (1946) (Bomb filling with 80/20 Amatol) x) A.N. Campbell & E.J. Pritchard, *CanJRes* **25B**, 183-97 (1947) & *CA* **41**, 4647 (1947) (It was hypothesized that cavitation & shrinkage in expl charges could be eliminated if it were possible to slow crystallization so that the melt would remain liq for a while at RT. Attempts to prepare expl mixts with such properties were unsuccessful) y) I.E. Aske, USP 2439443 (1948) (Casting app for vibrating molds) z) P. Campbell & W.H. Maxwell, USP 2439450 (1948) (App compensating for shrinkage of cast expls) aa) L.F. Audrieth & D.D. Sager, USP 2482089-91 (1949) (A cast expl obtained by pouring a suspension of RDX or EDNA into a liq melt of TNT contg Tetryl or PETN) bb) A.R.V. Steele et al, *BritP* 765210 (1957) (A head of liq expl held in a hollow former provides a flow of expl to compensate for any contraction as solidification occurs) cc) J.G. Holmes, *Ordn* **42**, 193-4 (1957) (Application of single-pour controlled cooling to filling bombs and other expl ordnance) dd) S.D. Stein & M.J. Margolin, "Proposed Shell Loading Standards Based on a Statistical Study of Setback Sensitivities", *PATR* **2563** (1958)

Loading Factor. Expressed as percentage, is the weight of HE fill of an ordnance item divided by the total weight of the item, multiplied by 100

Lobbe Explosive. Mixt patented in Eng in 1861 contg Na nitrate, sawdust and lime
Ref: Daniel (1902), 411

Locust-gum. Proposed as a waterproofing coating for AN grains in so-called "water-resistant" expls
Ref: W.J. Taylor, USP 2654666 (1953) & *CA* **48**, 3692 (1954)

Logistics. Those aspects of military operations

that deal with (1) design and development, acquisition, storage, movement, distribution, maintenance, evacuation, and disposition of materiel; (2) movement, evacuation, and hospitalization of personnel; (3) acquisition or construction, maintenance, operation, and disposition of facilities and (4) acquisition and furnishing of services. It comprises both planning, including determination of requirements, and implementation
Ref: *OrdTechTerm* (1962), 180

Long Tom. Popular name for US 155mm self-propelled gun used during WWII. Extremely accurate, it fired a 95-lb proj a distance of 25700 yds. It weighed 15 tons and had a barrel length of about 23 ft. During the assault on the Siegfried Line these guns assisted in the destruction of 120 pillboxes, obliterating one with each round fired from a range of 300 yds

The name has also been applied to the US 155mm self-propelled gun M-53, currently used by the Army and Marine Corps. It is full tracked to provide mobility for the gun and protection for the crew of six in offensive combat

Ref: J. Quick, "Dictionary of Weapons and Military Terms", McGraw-Hill, NY (1973), 281

Loss of Weight Stability Tests. Expls are heated at some predetd temp and the loss of weight is measured periodically. Usually, the greater the weight loss, the less stable is the expl

In Ger, 10g samples of industrial blasting expls were placed in loosely covered weighing bottles and heated at 75° for several hours (Ref 2). Guichard (Ref 1) devised an automatic balance to eliminate removing the expl sample from the const temp oven for cooling and weighing
See also Heat Tests in Vol 1 of *Encycl*, p XV
Refs: 1) M. Guichard, *BullSocChim (Fr)* [4], **39**, 1113 (1926) & [5], **3**, 115 (1936); *Ann-Chim (Paris)* **9**, 324 (1938) 2) Reilly (1938), 93

Lovelace. Invented a priming expl consisting of K chlorate, PA & MF, and an expl powd contg K chlorate, PA & charcoal

Ref: Daniel (1902), 411

Low Detonation Pressure Explosives. Most expl materials in wide use today may be characterized by deton pressures ranging from approx 150–350 kilobars. Propnt materials, on the other hand, exhibit comparatively low press typical of deflgrn reactions. The difference in pressures exhibited by these two classes of materials leaves an interesting gap, the exploration of which may yield valuable information on the propagation and kinetic limitations of detong materials

The reliable generation of deton press under 100 kilobars should offer advantages from an engineering viewpoint in applications where higher pressures are neither needed nor desired. Certain plastic/expl formulations described (Ref 1) offer these advantages in addition to others, such as the capability of being extruded or injection molded into difficult configurations and then polymerized in place. Expls included superfine PETN, acetone fine RDX, dextrinated LA and Thallous Azide

Refs: 1) M.T. Abegg, H.J. Fisher, H.C. Lawton & T. Weatherill, *Explosivst* **18**, No 2, (Feb 1970), 25–31 2) Anon, *Expls&Pyrots* **3** (9), 1970

Low Energy Detonating Cord (LEDC). When detong cord is not required directly to initiate HE, but solely to transmit deton from one place to another, it is advantageous to use a cord with very low charge weight. LEDC consists of an extremely small core load of HE, one or two grains per ft, which is contained in a small continuous lead tube. The lead tube is protected by wrappings of paper or cotton cord and an outer jacket of plastic. The countering provides good tensile strength and unlimited w resistance. LEDC has a vel of deton of 24000 ft/sec, slightly faster than standard detong cord (Ref 2)

When used for laying above ground to connect shots in civil engineering, quarrying and open-pit operations, LEDC has the advantage of producing much less noise than the normal

grade. This avoids any requirement of covering the cord with earth or sand when used in populous areas (Ref 1)

See also Cord, Detonating in Vol 3 of Encycl, p C529-R

Refs: 1) S. Fordham, "High Explosives and Propellants", Pergamon Press, NY (1966), 134–5 2) Blasters' Hdbk (1969), 107–8

Low Explosive (LE). An expl which when used in its normal manner deflagrates or burns rather than detonates; that is, the rate of advance of the reaction zone into the unreacted material is less than the vel of sound in the unreacted material. Low expls include propnts, certain primer mixts, BlkPdr, photoflash pdrs and delay compns. Whether an expl reacts as a HE or LE depends on the manner in which it is initiated and confined. For example, a double base propnt when initiated in the usual manner is a LE. However, this material can be made to deton if the propnt is initiated by an intense shock. Conversely, a HE like TNT, under certain conditions, can be ignited by flame and will burn without detonating

Ref: OrdTechTerm (1962), 181-R

Low-Explosive Devices for Performing Mechanical Functions. Known as actuators or cartridge actuated devices (See Encycl 2 (1962), C70–C72) low-explosive devices are small parts in which a propnt is ignited to produce gas. The gas generated performs such mechanical functions as closing switches, actuating valves, cutting cables, severing bolts, dispensing fluids, inflating bags, or starting engines

Basically, the devices are of two types, small actuators like dimple, bellows, or piston motors and larger pressure cartridges and gas generators. They are compact, efficient, reliable, inexpensive, and deliver a burst of mechanical work in a short period of time. Actuators provide a force over a small distance while gas generators exploit the energy of expanding gas

Ref: G. Cohn, "Low-Explosive Devices for Performing Mechanical Functions", Proceedings of the New Mexico Section of the ASME (Behavior and Utilization of Explosives in Engineering Design) (2–3 March 1972)

Low Freezing Dynamites (LF Dynamites).

See under Dynamite (*Freezing of Dynamites Containing NG*) in *Encycl 5* (1972), D1588-R to D1593-L

Low Melting Ammonium Nitrate Explosives.

See under Ammonium Nitrate Blasting Explosives, High Explosives and Propellants (*AN High Explosives*) in *Encycl 1* (1960), A346-R to A348-L, A352-R

Low Order Burst. Functioning of a proj or bomb in which the expl fails to attain a high order deton. Usually evidenced by the breaking of the container into a few large fragments instead of a large number of smaller fragments
Ref: *OrdTechTerm* (1962), 181-R

Low Order Detonation. See under Detonation, High-, Low-, and Intermediate Order, Velocities of, in *Encycl 4* (1969), D384-R to D389-R

Low Temperature Effect on Explosive Properties.

Tests conducted at temps of -80° and -183° with expls commonly used in detonators showed that the vel of deton and Trauzl lead block expansion values were practically unaffected, while brisance, as indicated by the lead plate test, was greatly reduced. The performance of detonators, as judged by an initiation test on unconfined cartridges contg LOX (qv) expls, was also greatly reduced. Only detonators contg Mannitol Hexanitrate, when immersed in LOX expls for 3 minutes at -183° , resulted in complete deton (Ref 1)

Burning, and the initiation, growth, and propagation of expls are often retarded or prevented by very low temps. Tests of blasting caps at liq nitrogen temps showed much decreased sensitivity (Ref 3)

The effect of low temps upon the sensitivities of initiators is usually quite small because the change from room temp is only a small fraction of the rise associated with initiation. However, systems that are marginal with respect to growth or propagation of expl reaction will usually fail in low temp testing (Ref 3)

The most noticeable effect of low temp upon stable deton results from a shrinkage in vol. Because of the higher d at low temps, deton velocities, and consequently deton pressures, are higher. These increases are too small to have practical significance. Where propagation time is critical, and must be synchronized with a process that is independent of temp, this effect, now accentuated by reduction in distance, can be a source of difficulty (Ref 2)
Refs: 1) L.V. Clark, *SS 28*, 345-8 (1933) (In English) & *CA 28*, 1191 (1934) 2) G.V. Horvat & E.J. Murray, "Propagation of Detonation in Long Narrow Cylinders of Explosives at Ambient Temperature and at -65°F ", *PATR 2389* (1957) 3) Anon, *EngDesHndbk*, "Explosive Series—Explosive Trains", *AMCP 706-179* (1974), 4-11

Lubrication

Fuzes. A lubricant is expected to perform the jobs of minimizing friction, wear, and galling between sliding or rolling parts. It must do these jobs under two types of conditions: (1) those which are inherent in the component element itself — such as load, speed, geometry, and frictional heat — and (2) those which are imposed from external sources — such as temp and compn of the surrounding atm, nuclear radiation, inactive storage, vibration, and mechanical shock. The imposed conditions are usually the more restrictive ones for lubricant selection

Mechanical fuze components contain elements which undergo a variety of sliding and rolling motions, and combinations of the two. For example, a mass translating on guide rods involves linear sliding only, the balls in a ball bearing involve essentially all rolling motion, and meshing gear teeth surfaces experience both rolling and sliding motions. For any given type of motion, the lubricant found to be satisfactory in one case will not necessarily be suitable for another if loads, speeds, etc, are not similar

Selection of the proper lubricant requires not only knowledge of the specific function which the lubricant is required to perform in the device being lubricated but also consideration of the interactions include chemical processes — such as corrosion of the metal parts

by components of the lubricant, eg, corrosion due to oxidation of MoS_2 in the absence of suitable inhibitors, or solution of copper alloys during lubricant oxidation processes; or physical interactions, eg, attack by active organic materials on synthetic elastomers and plastic structural members. In addition, the inherent stability of the lubricant must be considered. Stability is of particular importance if storage for long periods of time with or without elevated temps (which speeds up oxidation rate) is involved. (In general, lubricants are inhibited against oxidation by appropriate additives, but since temp is an important parameter, the oxidation stability characteristics of the lubricant should be taken into account in connection with the expected storage life and pertinent temps of the mechanism being lubricated). Oxidation of fluid or semi-fluid lubricants may lead to thickening of the lubricant with consequent increased forces being required for operation, or corrosive attack on the materials of construction

A wide variety of fluid and semi-fluid lubricants is available covering a wide temp range of applicability, a range of compatibility with organic and inorganic structural materials, and a range of other properties which may be pertinent, eg, nonspreading, lubricity, etc. In addition, both dry powdered and bonded solid-film lubricants are available. The choice of a lubricant depends on the totality of functions which the lubricant must perform, and the structural and functional features of the mechanism being lubricated. For example, a very severe nonspreading and low vapor pressure requirement in connection with long term storage may lead to a choice of a solid lubricant; whereas adhesion problems with bonded lubricants at high loads or with thin films associated with low mechanical tolerances may complicate the use of dry film lubricants. In fuzes subject to high rates of spin (above 25000 rpm), fluid and semi-fluid lubricants tend to be displaced by centrifugal force causing loss of lubricant and possible contamination of other fuze parts. Requirements for corrosion protection may require additives not accessible with dry lubricants

In simpler fuzes, choice of proper materials, plating, and finishes can obviate a separate lubricant

Descriptions of available lubricants — oils, greases and solid — with summaries of their properties are contained in Ref 5

Space Applications. All known liquid lubricants and fatty acids evaporate, and they are, therefore, unsuitable for space conditions. Tests showed that liquid lubricants do not even provide adequate lubrication in the lower vacuums of space simulators. Solid lubricants, such as molybdenum disulfide, tungsten disulfide, and the soft metals have given better results. However, the known data about space lubricants are results of simulator measurements made in the pressure range of 10^{-5} to 10^{-6} torr which does not simulate real space conditions, and therefore, these available data cannot be considered completely valid. It can be expected that definite data on lubricant performance in a vacuum will be obtained by conducting tests in a simulator that reaches the low 10^{-10} torr range. At this press level, the monolayer formation time is increased to at least several hours which will result in a sufficient time span for observing the metal surfaces (Ref 6)

Explosives. Lubricants are utilized in HE's to minimize compn adherence to dies used for pelleting and press loading operations. Typical of materials used with Tetryl have been graphite, stearic acid, Ca, Ba and Mg stearates (Refs 1, 2 & 3). Forchielli (Ref 4) reported on the beneficial effects of the metallic stearates (Ca, Li, Co, Zn & Cr) and talcum pdr with Composition A-3

Refs: 1) E.F. Reese, "Develop Process for Reclamation of Tetryl Scrap Containing Stearic Acid", PATR 1131 (1941) 2) G. Weingarten, "Develop Improved Lubricant and Binder for Pelleting Tetryl", PATR 1261 (1943) 3) Ibid, "Use of Calcium Stearate in the Pelleting of Tetryl", PATR 1337 (1943) 4) A.L. Forchielli, "Desensitization of High Explosives by Waxes, Semi-Plastic RDX Compositions", PATR 1787 (1950) 5) Anon, "The Lubrication of Ammunition Fuzing Mechanisms", Journal Article 49.0 of the JANAF Fuze Committee (May 1967), AD 829-739 6) K.O. Bauer, "Handbook of Pyrotechnics", Chemical Publishing Co, NY (1974), 313

Luck and Cross. Prepd, in 1898, proplnt powds by adding aq solns of Pb and Zn acetates to NC as stabilizers. This addition could be conducted in the presence of 30–50% acetone, after which the mixt was dried

Ref: Daniel (1902), 412

Luck and Durnford. Proposed, in 1896, to prepare proplnt powd from nitrated hydro-cellulose which had been treated with aq starch soln. This allowed the material to be compacted into grains, blocks, leaflets, etc

Ref: Daniel (1902), 411-12.

Luck Powder. A proplnt proposed, in 1900, for use in shotguns. It consisted of NG powd in which the NC was replaced by either cellulose acetate, butyrate or benzoate. This substitution permitted the prepn of sporting powds with a slow rate of combustion

Ref: Daniel (1902), 413

Luminous Phenomena. See Detonation (and Explosion) Luminosity (Luminescence) Produced on, in *Encycl* 4 (1969), D425-L to D434-L; Flash and Flame in *Encycl* 6 (1974), F74-R to F75-L, and Fluorescence, Luminescence and Phosphorescence, F124-R to F125-L

Addnl Refs: 1) A. Michel-Lévy & H. Muraour, *CR* 206, 1566–8 (1938) & *CA* 32, 5629 (1938) (Luminosity of expls) 2) H. Muraour, A. Michel-Lévy & J. Rouvillois, *CR* 208, 508–10 (1939) & *CA* 33, 3157 (1939) (Luminosity of expls) 3) H. Muraour, *Chim&Ind (Paris)* 47, 3–15 (1942) & *CA* 37, 6461 (1943)

[Luminosity has its origin in the shock waves generated by expls, and not in emitted gas as claimed by Lafitte, *CA* 29, 1324 (1926)]

4) A. Michel-Lévy & H. Muraour, *CR* 224, 695–6 (1947) & *CA* 41, 5723 (1947) (Origin of luminosity which accompanies the firing of expls in untamped drill holes. It is not a function of the gas evolved, but of the amt of air in the hole) 5) L. Deffet & P. vanWouwer, *Chim&Ind (Paris)* 69, 1086–7 (1953) & *CA* 49, 6608–9 (1955) (Luminosities produced by expl shock waves)

Lundholm and Sayers. Proposed in 1899 (BritP 10376) methods for the manuf of several expls, eg, mixts of NC with nitro-aromatic compds, mixts of oxy- or hydro-NC with various organic compds, etc. They also proposed charging projectiles by introducing expls in layers

Ref: Daniel (1902), 413

Lunge, Georg. (1839–1923). Ger chemist, noted for work on technological analytical methods. Inventor of the nitrometer (See below); author of numerous publications, among them (in collaboration with E. Berl), “Chemisch-technische Untersuchungsmethoden”, a classic work on technical analysis

Ref: Hackh's (1944), 501-R

Lunge Nitrometer. An app designed by G. Lunge for the detn of nitrogein in either organic or inorganic nitrates. It is so designed that the nitrate or nitric ester is dissolved in concd sulfuric acid and the soln, without entrained gas, is afterwards admitted to a reaction vessel. The nitric oxide gas from the reaction is measured in a mercury eudiometer in cc at atm press, a barometer and thermometer are read, and the wt of nitrogen in the nitric oxide and the percentage of nitrogen in the sample are calcd (Ref). This app was subsequently modified by the DuPont Co, and is known as the DuPont Nitrometer (See *Encycl* 1 (1960), A373-L to A377-L for description of use)

Ref: Davis (1943), 270–1

Lupersol DDM. A proprietary catalyst of Wallace & Tiernan, Inc, Buffalo, NY, contg 60% methylethylketone peroxide in dibutylphthalate, used as the hardener in Laminac (qv)

Refs: 1) *OrdTechTerm* (June 1962), 183-R 2) Anon, *EngDesHdbk*, “Military Pyrotechnics Series, Part Three – Properties of Materials Used in Pyrotechnic Compositions”, *AMCP* 706-187 (Oct 1963), 183–4

LX Explosives. A code employed by the Lawrence Livermore Laboratory, Univ of California (Livermore), USA, to designate formulations in production. A specific code designation is assigned to an expl when the state of development of its formulation has reached the point where a set of reasonable manufg specifications can be written, the evaluation of the material's chemical, physical, expl props and sensitivity is essentially complete, and the material has a definite application

This code consists of the two letters **LX** followed by a dash, two digits, a second dash, and finally a single digit. The first pair of digits is merely an arbitrary serial number assigned in sequence, while the last digit denotes a subclass in the series. Thus, **LX-01-0**, **LX-02-1** **LX-05-0**, etc. The last digit provides for small changes in manufg specifications. For example, when **LX-04-0** has undergone a revision of expl particle size, new lots, manufd under the revised specification, are identified as **LX-04-1**

LX-01 is a liq material, characterized by a wide liq range (-65° to $+165^{\circ}$ F), moderate energy release, and good stability and sensitivity props. *Caution:* The TNM component is moderately volatile and highly toxic

LX-02 is a material of putty-like texture characterized by ability to propagate in very small diameters

LX-04 is a solid expl characterized by excellent mechanical and compatibility props, an energy release about 9% less than **LX-09** and sensitivity props much superior to **LX-09**

LX-07-2 is a modification of **LX-04** with a higher energy release (5% less than **LX-09-0**), obtained at the expense of some degradation in mechanical props (less elongation, etc) and in sensitivity

LX-08 is an extrudable, curable expl developed for use in Dautriche timing tests

LX-09 is similar to the LASL expl **PBX-9404**, but with significantly improved thermal stability and slightly poorer physical props

LX-10 is in the same energy class as **LX-09** and **PBX-9404**, but utilizing HMX and Viton A like **LX-04**, and having excellent thermal characteristics. It also exhibits high creep resistance, but may be somewhat more sensitive

than the others

LX-11 is like **LX-04**, but intentionally degraded in energy by adding an addnl 5% binder

LX-13 is a variant of the LASL expl **XTX-8003**
Ref: B.M. Dobratz, "Properties of Chemical Explosives and Explosive Simulants", Lawrence Livermore Laboratory, Univ of California (Livermore), **UCRL-51319** (15 Dec 1972), pp 3-3, 3-4, 17-1, 17-2

Typical LX formulations are given in the following table:

Explosive	Formulation		Color
	Ingredient	Weight %	
LX-01	Nitromethane	51.7	Clear
	Tetranitromethane	33.2	
	1-Nitropropane	15.1	
LX-02-1	PETN	73.5	Buff
	Butyl rubber	17.6	
	Acetyltributylcitrate	6.9	
	Cab-O-Sil *	2.0	
LX-04-1	HMX	85.0	Yellow
	Viton A **	15.0	
LX-07-2	HMX	90.0	Orange
	Viton A	10.0	
LX-08	PETN	63.7	Blue
	Silicone rubber	34.3	
	Cab-O-Sil	2.0	
LX-09-1	HMX	93.3	Purple
	p-DNPA	4.4	
	FEFO ***	2.3	
LX-10-0	HMX	95	Bl-grn spots on white
	Viton A	5	
LX-11-0	HMX	80	White
	Viton A	20	
LX-13	PETN	80	Green
	Silicone rubber	20	

* Cab-O-Sil — trademark for colloidal silica particles

** Viton A — trademark for a synthetic rubber derived from vinylidene fluoride and hexafluoropropylene

*** FEFO — bis (2-fluoro-2,2-dinitroethyl) formal

Lycopodium (Club-Moss or Vegetable Sulfur).

Fine yellow powd consisting of flammable spores of *Lycopodium clavatum*, which grows in North America, Asia and Europe (Ref 3). It has been used in pyrotechnic formulations, eg, in green stars: Ba perchlorate 70.5, Mg powd 11.8, shellac 11.8 & lycopodium powd 5.9% (Ref 2). It is also a constituent of some expls (Ref 1), eg, in Leonard's smokeless powds (qv)

Refs: 1) Daniel (1902), 405 2) Davis (1943), 86 3) CondChemDict (1971), 530

Lyddite. Br expl, similar in compn to the Fr Melinite (qv). The name was derived from the town of Lydd, near which the expl was manufd and tested. It contains either PA alone, or in admixture with about 10p of other aromatic hydrocarbons, added principally to lower the mp of the PA. Lyddite was adopted in 1888 for charging torpedo warheads, and later during the South African war, for HE projectiles

Refs: 1) Daniel (1902), 414 2) Colver (1918), 14 3) Bebie (1943), 95 4) Davis (1943), 166

Lysol and Nitrated Derivative

Lysol. Brown, oily liq; creosote odor; poisonous. A mixt of alkali compounds of the higher phenols with fat and resin soaps. Obtained by boiling a mixt of heavy tar-oils, fats and resin with alkali. Sol in w, alc, eth, chl_f & benz (Ref 4). A registered trademark of Lehn & Fink Products Co, Bloomfield, NJ, for a cresylic disinfectant and antiseptic (Ref 3). On nitration it yields an expl

Nitrolysol (Nitrated lysol). Mp about 64°. Prepd by one-stage nitration of lysol. It has been proposed for use as an additive to reduce the mp of other expls such as PA. It is also suitable for the manuf of plastic expls, and for coating hygroscopic substances such as Na nitrate, to protect against moisture (Refs 1 & 2)
Refs: 1) E. Raynaud, FrP 449785 (1912) & CA 7, 2687 (1913) 2) Colver (1918), 692 3) Hackh's (1944), 503 4) CondChemDict (1950), 409; not found in later editions