

# EXPLOSIVES SCIENCE

Raymond N. Rogers and Joan L. Rogers

Los Alamos, NM

## Introduction:

Explosives are often played with as though they were toys. The persons playing with explosives are often too young to have accumulated sufficient formal education in chemistry and physics to understand the hazards involved. One intent here is to supply sufficient information to allow intelligent choices to be made in the handling and use of explosives.

The misuse of explosives causes a knee-jerk reaction against any scientific discussion of the materials. This is unfortunate. They have unique properties that can help us understand materials in general: they "talk to us" with energy. You can build defects into crystals and watch the effects through changes in the explosives' thermal properties and sensitivity. You can easily follow absolute-rate processes. True scientific applications of explosives can be fascinating and rewarding. We hope that the information presented here will suggest methods for using explosives in research.

Three broad categories of hazards can be observed in the use of explosives: sensitivity, stability, and toxicity. Each type of hazard must be considered before explosives are handled.

Safety tests for impact, friction, shock, and sparks generate *relative* scales for evaluating hazards. Different explosives are compared with one another. It can be stated that TNT is less sensitive than PETN; however, a quantitative statement can not be made about exactly how hard either must be hit to cause initiation under all conditions. Relative scales lack credibility: some small change in experimental conditions can cause errors in hazards interpretations. Many different relative tests must be run to improve the probability that all hazards have been identified.

Safety is estimated from *experience* with the materials. The experience usually involves an accident and the subsequent accident investigation. If one explosive rarely causes accidents and another is found to be less sensitive to impact, you might jump to the assumption that it will be less hazardous. That is a very dangerous assumption. ***Each explosive, formulation, and application must be investigated by many different safety tests.***

All initiations are thermal in nature. Detonations are characterized by a constant-velocity shock wave; however; the heat generated by chemical reactions supports the shock wave. An understanding of explosives requires an understanding of their thermochemical properties.

# Thermochemistry of explosives:

Self-heating accidents have often occurred when small-scale procedures have been scaled up without considering the effects of size. Safe amounts can be estimated in very straightforward ways. Other accidents have occurred when additional materials were added to previously safe operations. Such "compatibility" problems can be observed before they become a hazard.

A large number of tests has been used to observe relative thermal stabilities. In addition, some more recent quantitative methods can be applied to predicting safe temperature ranges for many important explosives. Each approach will be discussed; however, no attempt is being made to make a comprehensive review. All comments and perspectives are based on our experience alone.

## Relative Tests for Thermal Stability and Compatibility:

### Tests Involving Chemical Product Detection or Analysis:

All of the earliest tests are in this class, and many of the tests are still in use in different parts of the world. ***Erroneous conclusions will always be drawn from these tests when results are used to compare stabilities of materials that decompose to produce different products.***

**Abel Test:** One of the earliest tests is the Abel Test (1875). It observes the time required to change the color of starch/iodide paper when 1-gram samples are heated to 180° F. It is still used in the quality control of commercial cellulose nitrate (NC), nitroglycerin (NG), and nitroglycol. It can not be used to compare different types of explosives.

**Vieille Test:** The sample is heated at 110° C with a strip of litmus paper (1896). The sample is opened to the air overnight at room temperature, and the procedure is repeated until the paper turns red within one hour. The overall heating time is the quantity measured. A propellant powder passed by this test self heated to explosion in 1911, and two ships were sunk.

**Bergmann-Junk Test:** The test involves heating the sample to 132° C and determining extracted nitrites (1904). The test was much modified by Siebert in 1942, who used H<sub>2</sub>O<sub>2</sub> as the trapping liquid, added a better apparatus for trapping the NO, and titrated total acidity. The test works well for quality control of a single explosive, but it can not be used to compare dissimilar materials.

**Leclercq's Test:** This test (1950) involves the determination of the amount of NO and NO<sub>2</sub> liberated at 90° C as a function of time.

Changes in product composition will confuse all of these tests. For example, nitroguanidine decomposes to produce some ammonia. Ammonia changes total acidity and can react with oxides of nitrogen. None of the chemical tests observe the product of decomposition that causes self-heating accidents: ***heat.***

## Differential Thermal Analysis (DTA):

When self-heating is the problem, it seems only logical to make heat the quantity measured. DTA observes the production or absorption of heat by a sample.

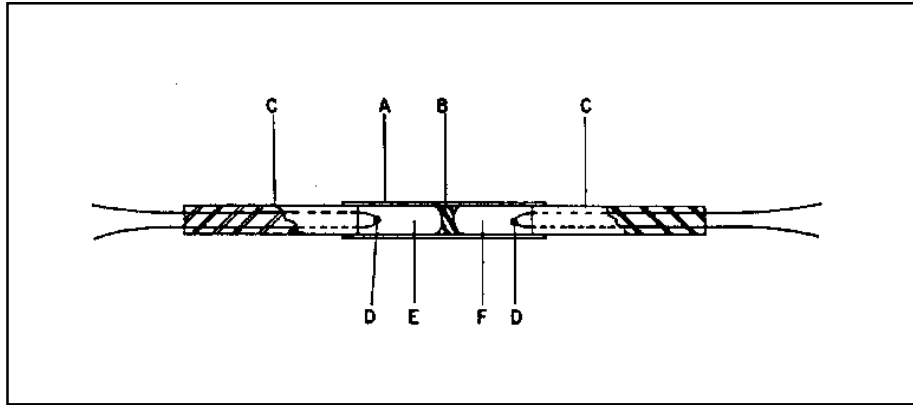

The figure shows a simple DTA cell for use with explosives. It uses two thermocouples on the same axis. Components: A, stainless-steel hypodermic tubing; B, ceramic plug; C, thermocouple insulators; D, thermocouples; E, sample compartment; F, reference compartment. A 0.125-inch OD tube is suitable for samples of about 3-30 milligrams. **Caution:** detonation of a 30 mg sample can be extremely hazardous. The DTA cell should be isolated within a secure shield. The cell can be slipped inside a ceramic or graphite tube furnace for heating.

The next figure shows the DTA "thermogram" of reagent-grade ammonium nitrate (the solid curve). The dashed curve is the "pyrolysis" (Effluent Gas Detection, EGD) curve, a technique that will be discussed below.

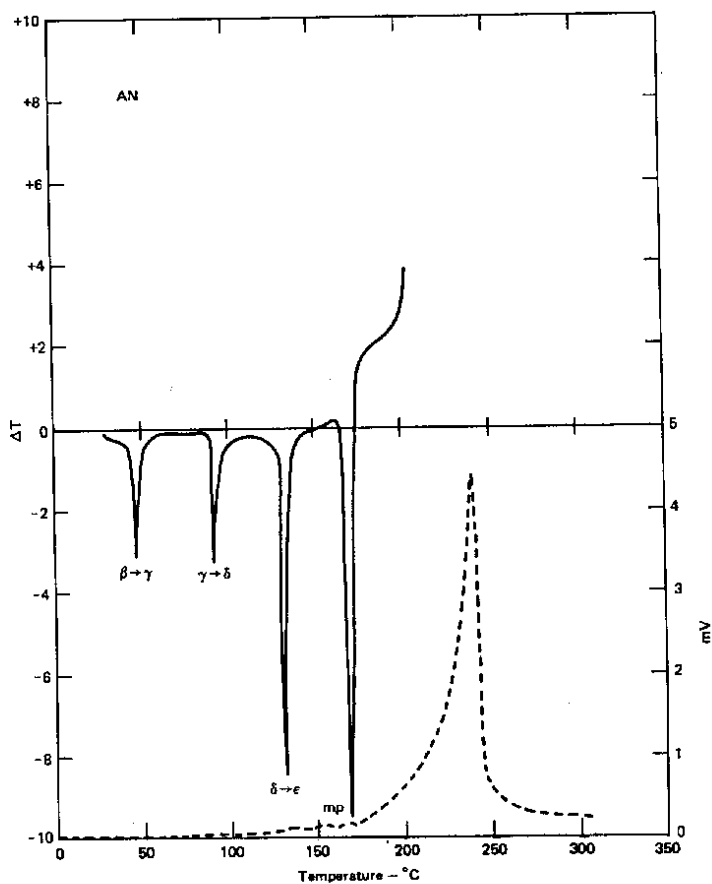

The downward peaks with negative  $\Delta T$ s indicate energy-absorbing processes. In the case of ammonium nitrate, there are three different changes in crystalline structure and melting. The melted ammonium nitrate starts to decompose exothermally immediately, and the curve rises into the  $+\Delta T$  range. The pyrolysis curve shows concomitant gas evolution.

The qualitative information available from DTA is very useful; unfortunately, quantitative measurements suffer from the fact that heat flow between the sample and the reference cells depends on the temperature difference between them and the average temperature of the system. The thermal sensitivity of a normal DTA system is not constant. It is usually not safe to make quantitative comparisons between dissimilar materials.

The first appearance of heat from a reaction (exotherm) is often used as a criterion for thermal stability. Different samples of the same explosive can be compared with some confidence when runs are made at the same heating rates; however, **simple DTA runs can not establish a reliable relative-stability scale for comparing different explosives.** This fact results from the ways different explosives decompose.



Very few explosives decompose according to simple rate laws, for example the first-order law shown to the left. When such a material is heated to some temperature, its rate of decomposition is immediately as high as it can get at that temperature. Its rate falls off exponentially as reactant is consumed over time.

The "order" of a reaction is indicated by the exponent of the depletion function in the rate equation. For example, a "second order" reaction has a depletion function  $(1 - \alpha)^2$ .

Most explosives decompose according to "autocatalytic" rate laws, as shown to the right. There is some delay at any temperature before they reach their maximum rate of decomposition: *the first appearance of a DTA exotherm will be shifted to a relatively higher temperature*. A very autocatalytic material will appear to be more stable than it really is.

The assumption is often made that it is safe to handle an explosive at any temperature below the first appearance of an exotherm in the DTA curve: ***That assumption is dangerously false!*** The highest safe temperature for handling any energetic material depends on its size, shape, and previous thermal history.

A normal DTA cell is somewhat sealed; therefore, the test is run in a self-generated atmosphere. Important heterogeneous and secondary reactions can often be observed. Tests involving reduced pressure or purging (for example, the vacuum stability test or thermogravimetry) will usually miss these reactions. Some of the most important compatibility problems can be identified by DTA in a self-generated atmosphere. However, in explosives work it is advantageous to run both confined DTA tests and unconfined or purged tests. The differences between the types of tests will often help identify safety problems involving confinement. **An explosive in a can or a bomb does not age the same as an explosive in the open.**

Several methods have been published for determining chemical kinetics constants with DTA apparatus. Erroneous results of different degrees will be obtained with all such methods when decompositions are complex, eg, autocatalytic. Simple decompositions are almost unheard of with explosives and propellants. **It is extremely dangerous to develop safety predictive models that**

are based solely on kinetics constants determined by DTA methods (or any other methods that use programmed temperatures). In any case, all predictive models must be confirmed by independent thermal-ignition tests.

One of the most important applications of DTA is the detection of chemical incompatibility. The explosive is run by itself at some controlled heating rate. Then the mixture in question is run ***under identical conditions***.

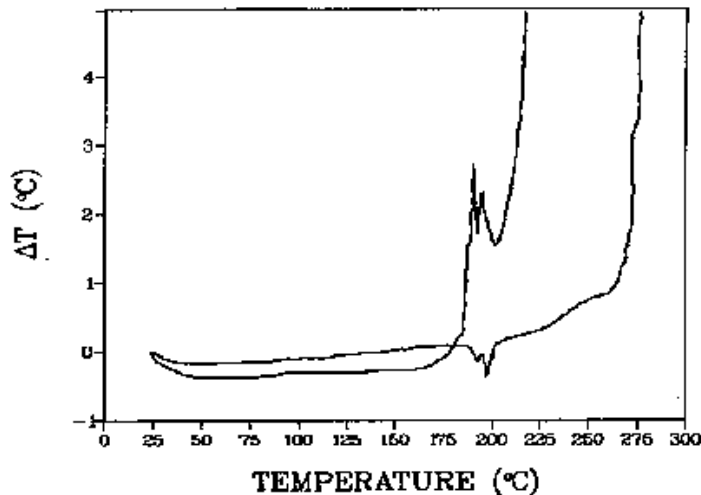

The figure shows the problem caused by adding lead powder to HMX. The lower curve shows a production-grade HMX. Its major impurity is RDX, as shown by the double endotherm below 200° C. The upper curve shows the same HMX mixed with lead powder. The endotherms have now become exotherms, and the sample explodes 50° C below HMX alone. The mixture is not safe, and a similar system self-heated catastrophically in a large press during fabrication procedures. Quantitative estimates of the difference between the HMX and HMX with lead can be made, but they can not be made from the DTA curves alone.

### Pyrolysis (Effluent Gas Detection, EGD):

In the pyrolysis (EGD) test, the explosive is heated at a linear rate under a flow of gas, and the decomposition products and/or volatile materials are detected in the gas stream as a function of temperature. Detection is accomplished with one of the normal kinds of gas-chromatography detectors, usually a thermal-conductivity detector.

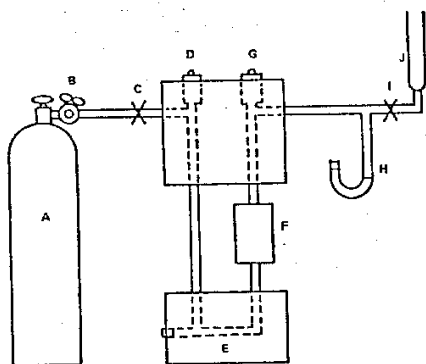

Schematic of pyrolysis apparatus at Los Alamos. A - carrier gas supply; B - pressure regulator; C - flow control; D - reference thermal conductivity cell; E - pyrolysis chamber; F - combustion tube; G - active cell; H - manometer; I - pressure valve; J - meter.

Decomposition products are immediately removed from the reactant, and heterogeneous reactions are usually eliminated. A comparison between DTA and EGD results allows phase transitions and reactions to be differentiated, and heterogeneous reactions can be detected. It provides a sensitive method for detection of impurities, solvates, and clathrates. Very sensitive detectors are available, and the sensitivity of the test can be very high, much higher than thermogravimetry.

The pyrolysis curve for ammonium nitrate is shown above with the DTA curve. The crystal transitions do not produce gas; however, materials that are trapped in the crystal lattice are released when the crystal structure changes.

Pyrolysis can be used to determine the vapor pressure of purely volatile materials.

EGD and most other gas-detection methods respond only to total gas evolved. Changes in mechanism during a decomposition result in changes in the kinds of gas produced as well as amounts and rates. Therefore, it is not safe to assume that the rate of appearance of gaseous products is the same as the rate of disappearance of reactant(s).

Comparisons between different samples of the same material, run at the same heating rate, can be very useful for quality control; however, comparisons among dissimilar materials must be carefully interpreted. Note that this same statement was made with regard to DTA tests. It is almost a truism that each type of test has its own shortcomings. It is far safer to compare the results obtained from many different types of tests than to depend on a single test.

## Pyrolysis-TLC:

A simple method related to EGD combines pyrolysis with thin-layer chromatography (TLC). The method involves programming a temperature-resistant thin-layer plate across the exit port of a pyrolysis cell as a function of time or temperature. The important distinction between constant-

temperature and programmed-temperature methods will be discussed later.

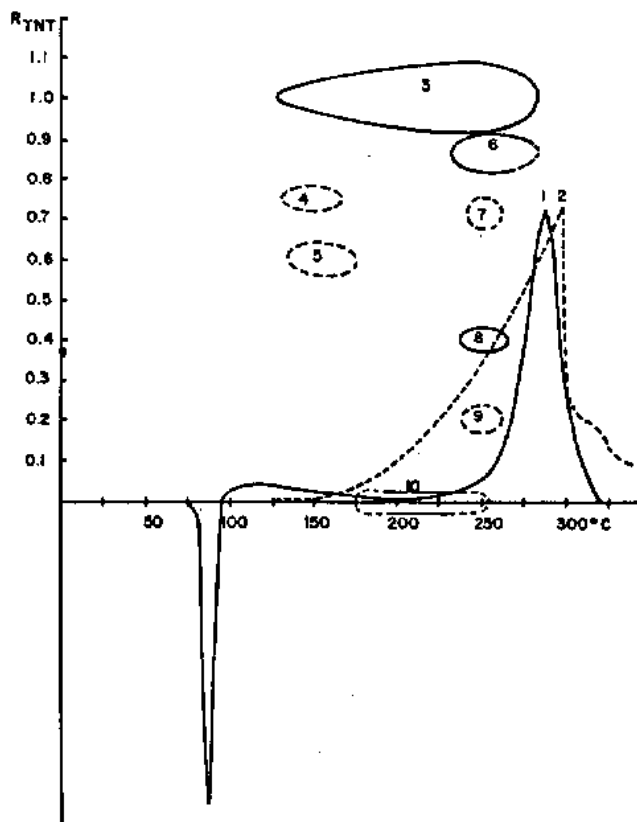

(1) DTA curve, (2) pyrolysis curve, (3) TNT zone, (4) 2,6- and 3,5-DNT zone, (5) 2,4-DNT zone, (6) TNB zone, (7) DNA zone, (8) TNB-OH zone, (9) unidentified zone, (10) TNB-a zone  
Sample 0.284 mg, heating rate 11°C/minute, air carrier gas

The TLC plate collects the higher molecular weight decomposition products before secondary reactions can occur, and the TLC plate can be developed to separate and identify the components. The individual decomposition products can be identified from their  $R_f$  values (how fast they move on the plate) and/or specific reagent sprays.

The figure shows an example that was produced with impure TNT. The corresponding DTA and pyrolysis curves are superimposed for comparison. Changes in decomposition mechanism can be detected, and subtle incompatibilities may be quite obvious.

The volatile TNT impurities, the dinitrotoluenes, and TNT vapor can be detected at temperatures slightly above the melting point (3, 4, and 5). True decomposition products appear at temperatures above about 250° C, consistent with the DTA and EGD results.

Kinetics constants can be determined by photometry of a TLC plate. However, an important distinction must be made between methods based on the rate of appearance of products and methods based on the rate of disappearance of reactant. An explosive may appear to decompose according to a simple rate law, but analysis of products usually shows that there are many component reactions: the process is complex.



None of the product- or gas-analytical methods give direct information on heat, the factor that causes self-heating accidents.

## Thermogravimetry (TGA):

In thermogravimetry a sample is heated at a linear rate while it is being weighed. Since it is difficult to embed a thermocouple in a sample while it is being weighed, there must be a compromise between weighing accuracy and sensitivity and accuracy of temperature measurement. The thermocouple in DuPont equipment is not in contact with the sample; therefore, a sample that self heats significantly will have a largely unknown temperature. Volatile reactant will escape as well as decomposition products, and the method will have all of the disadvantages discussed under other gas measuring methods.

With explosives and propellants, rapid decomposition reactions produce a thrust on the sample pan, causing erroneous mass measurements: the mass appears to increase as reactant decomposes. Catastrophic decompositions or detonations tend to destroy much expensive equipment.

## Vacuum Stability Test:

This old test is used all over the world for the determination of thermal stability and compatibility. It is often the *only* thermal test used, a situation that should be much discouraged.

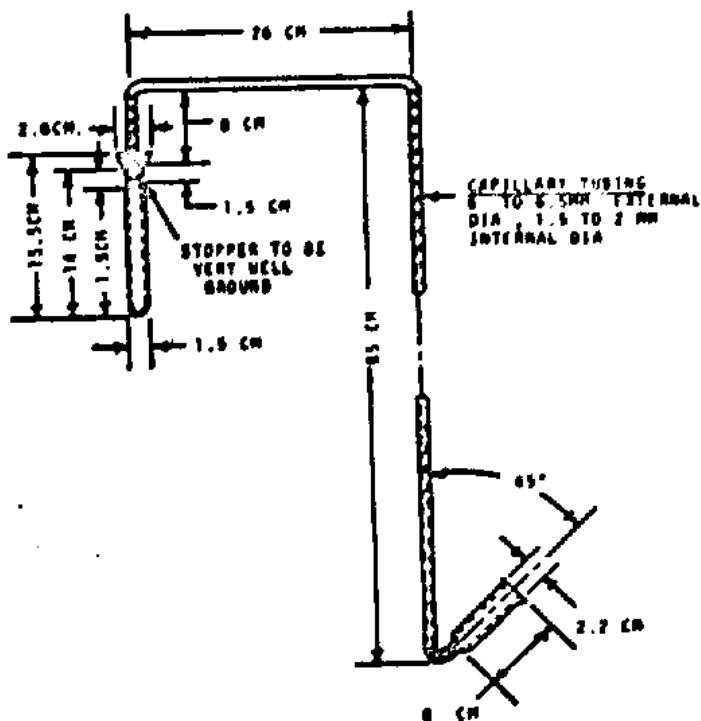

The figure shows a schematic of the vacuum stability apparatus. In running the test, a sample in a calibrated tube is connected to a manometer, mercury (toxic) is placed in a cup at the base of the

manometer, and the system is evacuated to approximately 5 torr. When evacuation is stopped, mercury rises in the manometer tube to some level, and the sample remains under vacuum. The sample tube is heated to a constant temperature, usually 90° C for double-base propellants, 100° C for single-base propellants, and as high as 200° C for some high explosives. The volume of gas produced is read as a function of time or at some specified time. Volume of gas is the value reported.

Volatile components and/or products distill into the manometer, some materials and products react with mercury, and the reduced pressure inhibits heterogeneous reactions. Explosives that decompose to produce different gaseous products can not be compared with the test, and interpretation is important under the best circumstances.

The test is cheap, and it can be a good control or acceptance test for monitoring different batches of the same explosive or formulation. It has the advantage of operating at a lower temperature than many other tests. It tends to miss rapid initial-rate processes and secondary heterogeneous or gas-phase reactions. Incidentally, RDX and HMX produce considerable formaldehyde on thermal decomposition, and polyoxymethylenes condense on the manometer tube.

The test is much used for compatibility determinations, comparing gas volumes obtained from a sample against volumes obtained from the sample mixed with a material in question. There is considerable controversy concerning what additional volume of gas indicates "incompatibility," and many arbitrary specifications have been published. Since many thermally active reactions do not produce much if any additional gas, and many multi-phase reactions require interaction through the gas phase, the test tends to miss important incompatibility hazards. Negative results are possible when the additive absorbs a gaseous product. Interpretation of such results is tricky. One laboratory, using the vacuum stability test as its only thermal test, lost a pressing facility to a mixture that passed the test.

### **Taliani Test:**

This test appeared in its basic form in 1904, before the introduction of the vacuum stability test. It is quite similar to the vacuum stability test, but it is designed to measure pressure at constant volume as a sample decomposes. A schematic of the apparatus is shown in the figure.

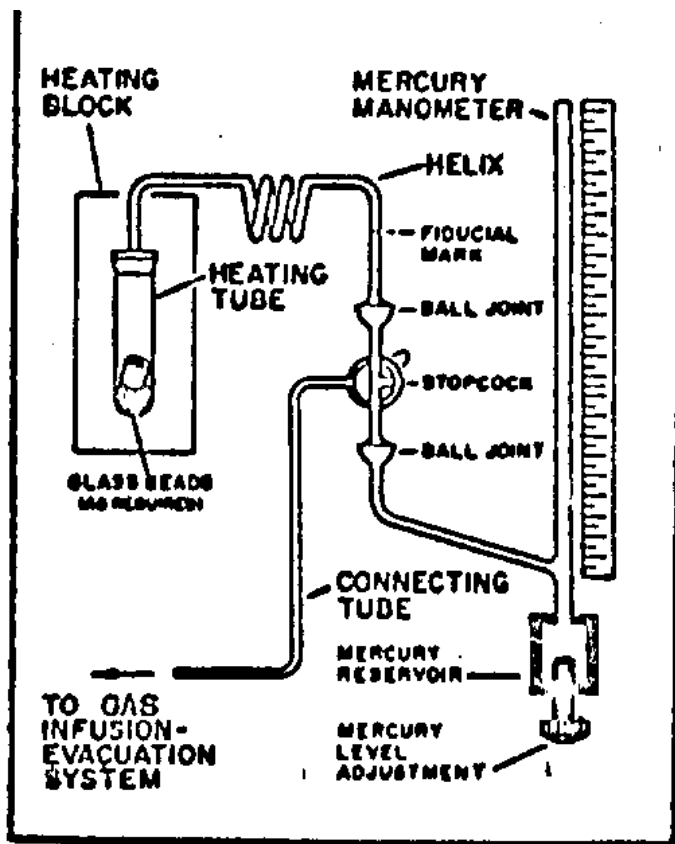

FIGURE 1. Taliani test apparatus.

Although it is normally run at reduced pressures (up to only about 100 torr), it can be run at higher pressures. At higher pressures it may see heterogeneous and/or gas-phase reactions. It is widely used in the propellant industry.

### Gun Propellant Surveillance Program (The "65.5° C Test"):

The program was initiated early in the 20<sup>th</sup> Century after the Navy had experienced several disastrous fires and explosions with smokeless propellants. The Naval Ordnance Station, Indian Head, MD, is now field manager for a program that keeps all gun propellants of the U. S. military establishment under surveillance.

Samples of propellant are received in 8-oz glass-stoppered bottles, and they are placed in an oven heated to 65.5° C (150° F). The bottles are checked daily for visible fumes, and those samples that fume in less than thirty days are believed to have reached their "safe-life" limit. Such samples are retested in the same way, and the "German Bath Test" and "Available Stabilizer Test" are added. Samples that fail these tests are destroyed or expended in a specified time. A very large number of samples is under surveillance at any given time. The test is not used for nonstandard propellants.

### Chemical Reactivity Test (CRT):

The CRT test is an attempt to improve on the vacuum stability test by using a higher pressure, maintaining volatile products in the vicinity of the sample, and analyzing the products *via* gas

chromatography.

In the standard test, the sample is heated at 120° C under 1 atm pressure for 22 hours. The sample is positioned below a diffusion plug to help keep gaseous products near the condensed phase. After the heating time, a two-stage chromatography unit is used to measure the individual volumes of N<sub>2</sub>, NO, CO, N<sub>2</sub>O, and CO<sub>2</sub>. Unfortunately, the most popular version does not normalize the products measured against the total amount of volatiles fed into the GC system. Volatile products that do not pass the columns are lost and are not detected or identified.

The effects of additives on volumes of the specific gases can be measured, providing some criteria for compatibility. In practice, total gas volume is the usual value reported, and results do not usually differ much from vacuum stability results. The test is much more expensive than the vacuum stability and Taliani tests, and it is probably not worth the additional expense for routine quality control operations.

### **Accelerating Rate Calorimeter (ARC):**

The ARC (Columbia Scientific Industries) is intended "to maintain a sample in an adiabatic state and permit it to undergo thermal decomposition due to self-heating while recording the time-temperature-pressure relationship of the runaway process." The ARC automatically calculates kinetics constants and reports them as "the" kinetics constants for the system. When used with solid explosives and propellants, the ARC has serious limitations and gives spurious results. It is dangerous to base predictive models on numbers obtained from the ARC. The problems with the ARC follow from the basic functions of adiabatic calorimetry.

The fundamental equation for adiabatic calorimetry is:

$$c_p \frac{dT}{dt} = Q f(\alpha) Z e^{-E/RT}$$

where  $c_p$  is the heat capacity,  $T$  is the temperature,  $t$  is time,  $Q$  is heat of reaction,  $\alpha$  is the fraction decomposed at any time,  $Z$  is the Arrhenius pre-exponential,  $E$  is the Arrhenius activation energy, and  $R$  is the gas constant.

If the equipment were truly adiabatic,  $c_p$  were constant over the temperature range, a single temperature described the sample at any time, and the mechanism did not change with depletion, the equation would accurately describe the time-temperature history of a decomposition. **None of these requirements are accurately met when using the equipment with solid or viscous samples of significant size and energy.**

Explosives produce energy on decomposition, and they generally have very low thermal

conductivities: they tend to self heat. They get hotter on the inside than they are on the outside. One temperature does **not** describe the system. This provides a major error in using the ARC with solid explosives and propellants.

When decompositions are complex, mechanisms change with temperature, depletion, and pressure: **Q and  $f(\alpha)$  are not constant**. This provides another major source of error.

**Procedures do not currently exist for obtaining accurate kinetics constants for the component reactions of complex processes involving solid explosives and propellants from ARC measurements.**

There are additional fundamental problems with the theory of adiabatic calorimetry. When the basic equation is integrated, you obtain the following equation that defines  $T(t)$ .

$$t = \int_{T_0}^T \frac{c_p e^{E/RT}}{z f(\alpha) Q} dT$$

An exact, explicit form for the solution of that type of equation has not been discovered, and approximations of different degrees of accuracy and complexity must be used. To make matters much worse,  $f(\alpha)$  has never been observed to be either a simple function or a single function for an explosive. ***The ARC should not be used in an attempt to obtain meaningful kinetics constants for solid explosives.***

## Time-To-Explosion Test:

Henkin and McGill published a time-to-explosion test in 1952 that was clever and simple. They attempted to obtain kinetics constants for explosives with no success. We now understand why their attempt failed, and we consider a modification of their test to be one of the most important thermal tests to run on explosives.

The "Henkin Test" used empty blasting-cap shells as containers for the explosive samples, immersed the samples in a constant-temperature Wood's metal bath, and measured the time to explosion. Henkin and McGill made Arrhenius Plots of time to explosion versus  $1/T$ , assuming that the slope of the line would be  $E/R$ . It wasn't, but the test proved to be very useful for other things; for example, it was a very good way to detect incompatible systems.

The Henkin Test has been much modified at the Los Alamos National Laboratory in order to provide a relative scale of thermal stabilities that can be justified on the basis of fundamental principles. The

modified test can also be used for the laboratory-scale experimental determination of critical temperatures for a known size and shape of explosive. As such, it is the test used to prove the accuracy of quantitative thermal-hazard models. It is a cheap and useful test.

When the surface temperature of any explosive charge is increased, it will either decompose quietly at a somewhat higher rate (ultimately rupturing its confinement as a result of the production of gaseous products), self-heat to explosion or detonation, or ignite and burn. Its response depends on its surface temperature, its size and shape, and its chemical and physical properties.

**The most important criterion for thermal safety is the "critical temperature" ( $T_c$ ),** defined as the lowest constant surface temperature at which a specific material of a specific size and shape will self heat catastrophically. The critical temperature is related to the size, shape, chemical, and physical properties of a specific material.

## CONDUCTIVE HEAT FLOW

### FRANK-KAMENETSKII

$$\frac{E}{T_c} = R \ln \left[ \frac{a^2}{\delta \lambda} \cdot \frac{\rho Q Z E}{T_c^2 R} \right]$$

## CONVECTIVE HEAT FLOW

### SEMENOV

$$\frac{E}{T_c} = R \ln \left[ \frac{V}{S \beta} \cdot \frac{\rho Q Z E}{T_c^2 R} \right]$$

Reactive heat flow equations have been solved with assumptions that are appropriate for highly energetic materials, and critical temperatures can be calculated for specific materials of a specific size and shape. The method used for the calculation depends on whether the explosive is a solid (conductive heat flow) or a liquid (convective heat flow). The two most important equations are shown in the figure.  $E$  is the Arrhenius activation energy,  $Z$  is the Arrhenius pre-exponential,  $T_c$  is the critical temperature,  $R$  is the gas constant,  $a$  is a dimension (radius of a sphere or cylinder, half thickness of a slab),  $\delta$  is essentially a dimensionless shape factor (3.32 for spheres, 2.00 for infinite cylinders, and 0.88 for infinite slabs),  $\lambda$  is the thermal conductivity,  $\rho$  is the density,  $Q$  is the heat of reaction,  $V$  is the volume,  $S$  is the surface area, and  $\beta$  is a heat-flow coefficient. A stirred liquid approaches the behavior predicted by the Semenov equation; a solid that does not melt closely approaches the behavior predicted by the Frank-Kamenetskii equation.

These equations can not be solved in the normal way: ***They must be solved by successive approximations.*** It is quite laborious to do that by hand. A programmable calculator can be used, or a much faster Basic program can be written for the computer. When all of the values except  $T_c$  are known, guess an arbitrary  $T_c$  and calculate values for each side of the equation. Keep trying different guesses until the two sides are identical. We usually set our programs to converge to within 0.1K.

Once a critical temperature has been determined experimentally for a specific size, shape, and density of a specific material, the value of the expression  $[\rho QZE/\lambda R]$  is specified. No assumptions have to be made about the material's properties at all.

Since the activation energy is specific to any material, a list of critical temperatures at the same size, shape, and density will provide a general, valid, relative scale for thermal stabilities. ***Different types of energetic materials can be compared on the same scale.*** We believe that an experimental determination of critical temperature is the most important single test to be run on energetic materials.

[See Picture next page]

The test as run at Los Alamos uses empty DuPont E-83 aluminum blasting-cap shells (copper alloy cells are incompatible with many explosives). 40 mg of explosive is weighed into the cell for the "standard" test, and it is confined with an aluminum plug. The plugs are hollow anodized aluminum

Los Alamos Scientific

OF THE UNIVERSITY OF

CM.

1 2 3 4 5 6 7 8 9

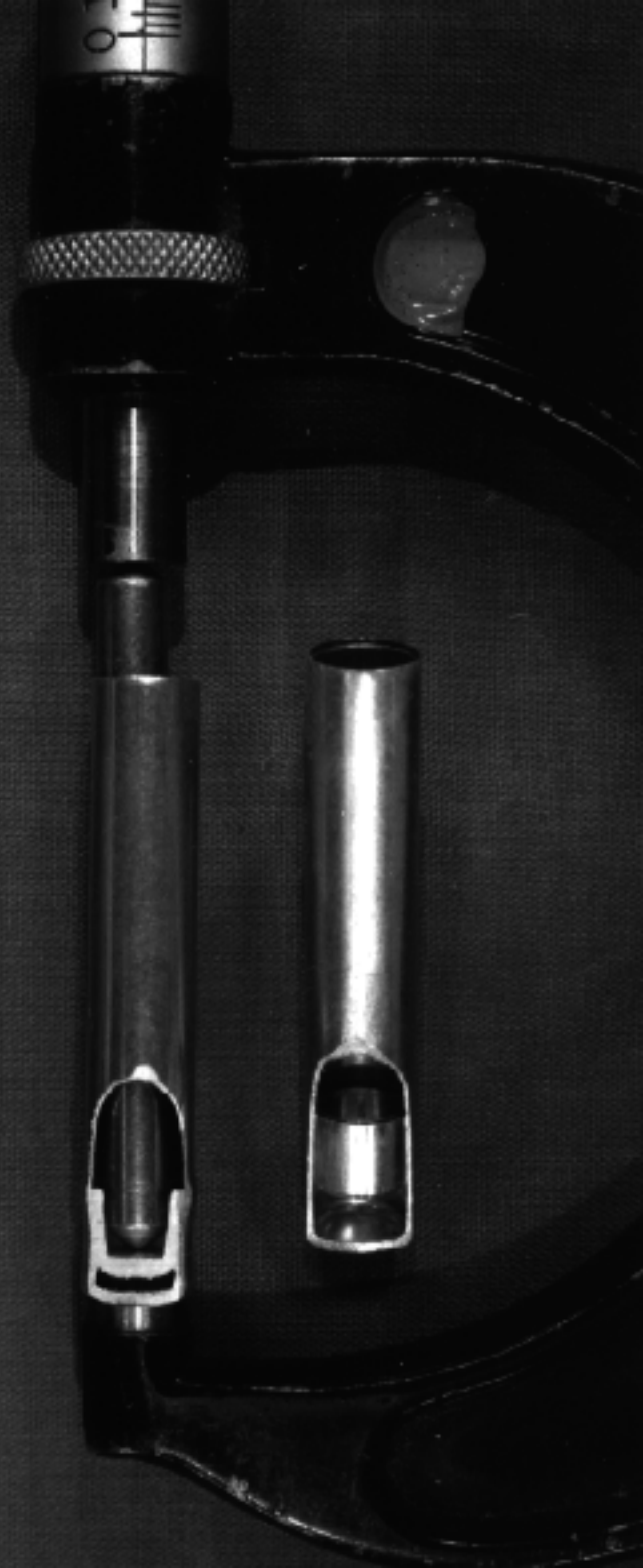
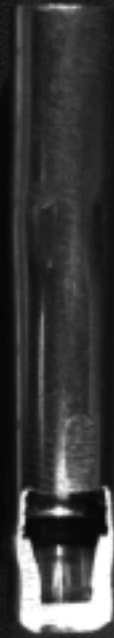



plugs 6.55-mm OD by 5.33-mm ID and 5.64-mm long, and they can be produced in large numbers on a screw machine. Standard Lee plugs have also been used. The sample, confining shell, and plug are pressed with a conical punch to a pressure somewhat less than 6100 p.s.i (400 pounds applied force), as required to expand the aluminum plug to form a seal. After pressing, sample thickness can be measured. The low thermal conductivity of explosives makes the thin wafer of sample act as an infinite slab. The half thickness is the "a" of the Frank-Kamenetskii equation. The completed assembly is dropped into a preheated metal bath at a known temperature (T), and the time to explosion is recorded. The lowest temperature at which an explosion (or other runaway reaction) can be obtained is  $T_c$ .

**CAUTION: Explosion or partial detonation of a 40-mg sample can be extremely destructive. Tests must be run with adequate shielding.**

The sealed cell maintains a positive pressure over the sample at all times; however, the thin aluminum wall stretches allowing gas to leak at higher pressures (somewhat like a Bunsen valve). The effect is a containment vessel that maintains a constant pressure of a few hundred p.s.i. We have found these cells very useful for other kinds of applications.

It is extremely important to recognize that the critical temperature determined applies **only** to the size and shape of the test.

The sample does not stop decomposing at temperatures below the  $T_c$  (see the discussion on the Arrhenius expression below), the rate is just not sufficient to cause an explosion. When a cell is opened after a "no-go," it is often found to be either empty or contain only a small amount of charred decomposition product. The original sample has decomposed quietly and completely.

An example of a relative stability scale, based on critical temperatures, is shown in the figure. It is important to notice that for maximum validity and accuracy, the samples should have as nearly as possible the same thickness (the dimension, "a," is squared in the Frank-Kamenetskii equation, making results sensitive to thickness). Density differences are much less important. The critical temperatures shown apply **only** to 0.8-mm-thick slabs ( $a = 0.4$  mm). Estimation of critical temperatures for other sizes and shapes will be discussed below.

# CRITICAL TEMPERATURE

FOR AN 0.8-mm-THICK SLAB

<u>MATERIAL</u>	<u>T<sub>c</sub> (°C)</u>
PETN	193
NQ	203
RDX	215
COMP B	216
EAK	245
HMX	249
TNT	286
TATB	329

A useful feature of the test is that time to explosion can be used for quality control purposes: **A reduced time to explosion for a new sample of a specific explosive indicates a less stable material.** The figure shows a comparison between time-to-explosion curves for pure and commercial ammonium nitrates. The critical temperatures (the temperature at which the lines become horizontal and explosions do not occur at any time) are nearly 100° C apart.

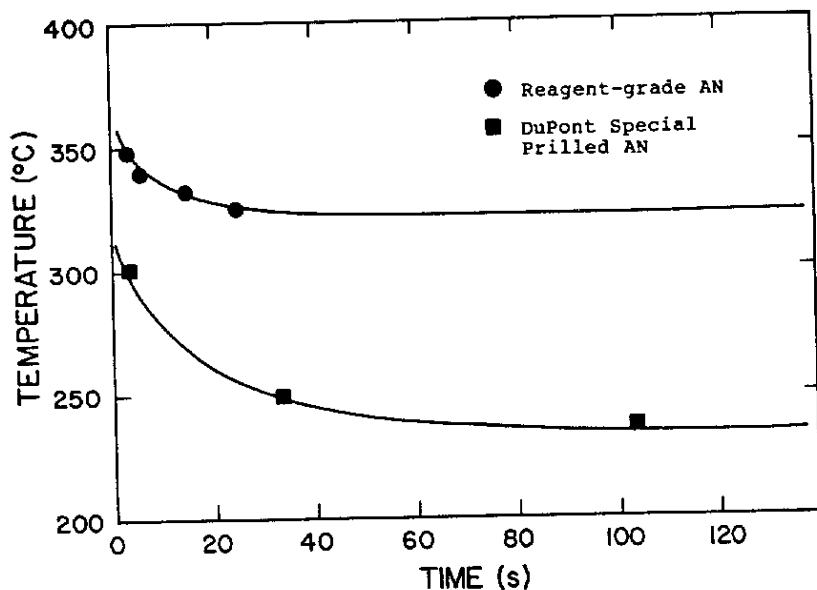

All of the tests in the figure were run on 0.8-mm-thick samples. A thicker sample gives a lower critical temperature. Results are quite sensitive to thickness, as would be expected from the  $a^2$  term in the Frank-Kamenetskii equation. Some care in sample preparation is rewarded with better precision in the results.

Similarly, when considering compatibility, reductions in time to explosion and/or critical temperature when another material is mixed with the explosive indicate **incompatibilities**.

However, the most important aspect of the test is that it can provide a small-scale, totally independent test for quantitative thermal-hazard predictions.

This test can also be used to make predictions for those situations where "no answer is not the right answer." When some "guess" must be made on the safety of an explosive, its  $T_c$  can be determined rapidly from a time-to-explosion curve. This specifies the value of  $[\rho QZE/\delta \lambda R]$ . If the density does not change appreciably, predictions can be made for other sizes and shapes. A familiarity with the properties of explosives makes it possible to guess an activation energy, if one can not be obtained. The accuracy of the resulting model can be tested to a first approximation by doubling the thickness of the sample tested and measuring another  $T_c$ . Some very violent reactions should be anticipated; however, this may be the only valid approach to making a necessary prediction.

### **One Dimensional Time-to-Explosion Test (ODTX):**

The ODTX test was an attempt to simplify mathematical analysis of time-to-explosion data. Its result was to complicate the problem and cause considerable confusion.

In the ODTX test, a spherical sample is confined between O-ring-sealed, heated "anvils," and the time to confinement failure is measured. A closing pressure of 1500 atm is standard, but the pressure can be controlled. Shapes of samples other than spheres have also been used.

The ODTX criterion for "explosion" is failure of confinement: *failure does not necessarily involve catastrophic self heating*. Indeed, ODTX operators recognize and report two different types of responses, "low order" and "high order." A material that decomposed to gaseous products endothermically would give an "explosion." Since different types of chemical processes can give the same result, the ODTX is not a simple reactive-heat-flow test. It is also extremely expensive.

### **Quantitative Predictions of Thermal Hazards:**

All energetic materials, whether they are called explosives or propellants, evolve heat when they decompose. The higher their temperature, the faster they decompose. From a box full of oily rags or a barn full of hay to an ICBM rocket motor filled with solid propellant, energetic materials can self heat with unfortunate results. Processing, design, quality control, and operational applications of systems using energetic materials all require an understanding of thermal hazards and an ability to predict safety limits.

The safest approach to hazards predictions involves an understanding of the fundamental chemical properties of the materials and the use of this knowledge for the production of *quantitative* models for hazards predictions.

The figure shows the basic problem: **THERE IS NO SUCH THING AS A SINGLE AUTOIGNITION, COOKOFF, OR CRITICAL TEMPERATURE FOR ANY ENERGETIC MATERIAL.**

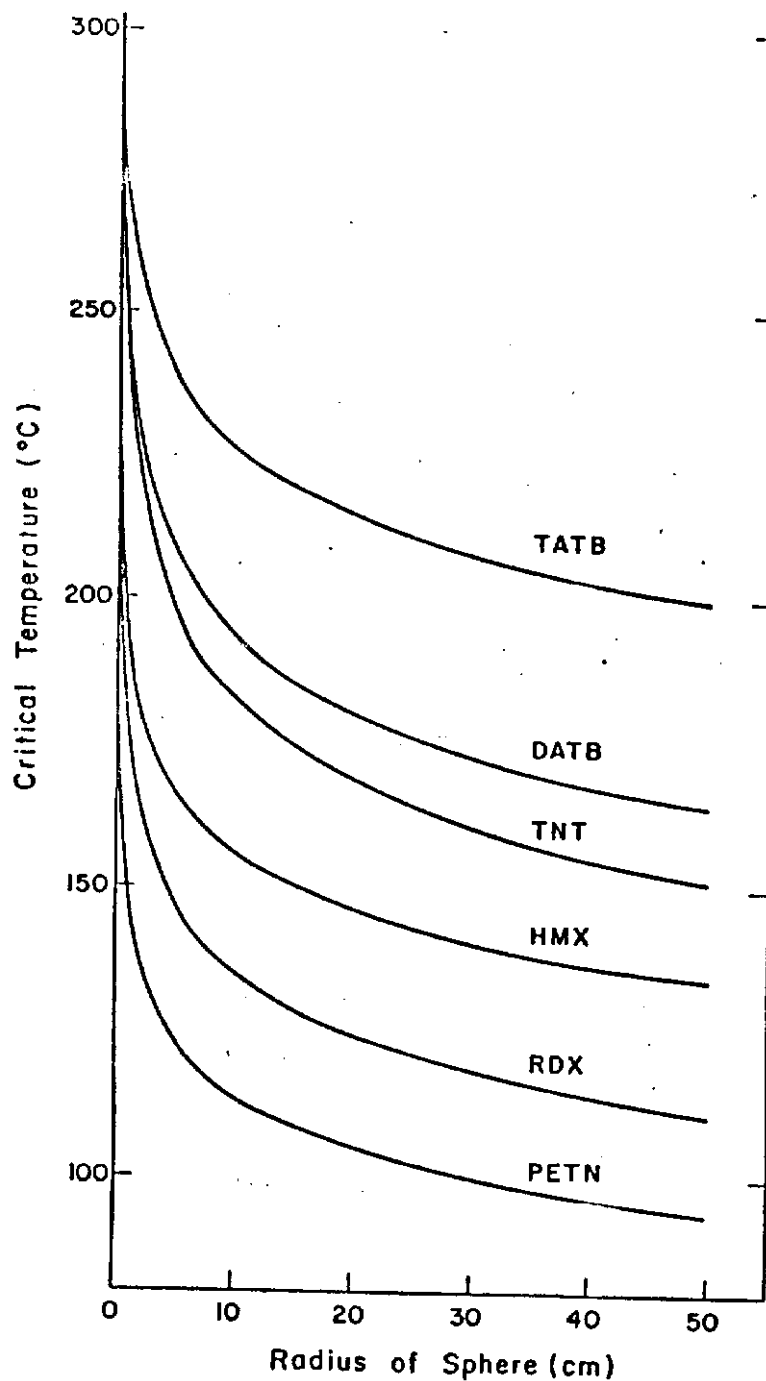

The temperature at which any specific energetic material will self heat to ignition or explosion depends on its chemical properties, its size, and its shape. The curves show that

there is a specific critical temperature for each explosive at each specific size of sphere.

The critical temperature is very sensitive to changes in size in the small-size range. It can change by nearly 100° C in the first 5-cm size range. *If we were to make cookoff measurements in 1/2-inch geometry and make the assumption that an 8-inch charge would survive the same temperature, an accident would almost certainly be the result.*

Even though a barn full of hay may ignite and burn, a handful of hay will not burn your hand.

Differences in shape are not nearly so important as are changes in size. For practical purposes, the critical temperature for some rather irregular shape can be estimated by circumscribing it with a regular shape. The estimated  $T_c$  will not be lower than that for the peculiar shape.

## The Concept of a Critical Temperature:

As discussed under the time-to-explosion test above, it can be demonstrated experimentally that there is a specific constant surface temperature below which a material of a specific size and shape will fail to self heat catastrophically. The temperature that divides catastrophic events from simple decomposition is called the **critical temperature,  $T_c$** . The critical temperature is the most important value to predict when the thermal safety of any material or process is in question.

It must be remembered, however, that energetic materials still decompose at temperatures below the critical temperature. If they are sealed in a container, gas pressure will build up until the container ruptures. The result may look like an "explosion"; however, extremely violent responses can be expected at temperatures above  $T_c$ .

## Mathematical Models for Critical Temperature:

As discussed under the time-to-explosion test, the Frank-Kamenetskii equation provides a good model for a solid explosive or other energetic material; the Semenov equation can be used to model energetic liquids. It was also mentioned that the equations must be solved by successive approximations.

The Frank-Kamenetskii model assumes that a thermal gradient will be established across a mass of the material: it will be hotter at its center than at its surface. The Semenov model assumes a perfectly flat temperature distribution, as approached by a rapidly stirred liquid. The heat-flow coefficient,  $\beta$ , is usually between about 0.0105 and 0.0135 cal cm<sup>-2</sup> s<sup>-1</sup> K<sup>-1</sup> for thin glass walls (eg, a flask). It will be about 0.018 for fluid-jacketed melt kettles and about 0.0015 for steam-jacketed kettles.

The activation energy,  $E$ , and the pre-exponential,  $Z$ , are the largest numbers in the equations, and it is important that they be determined with good accuracy. The figure illustrates the problem. It shows different critical temperature predictions for a material

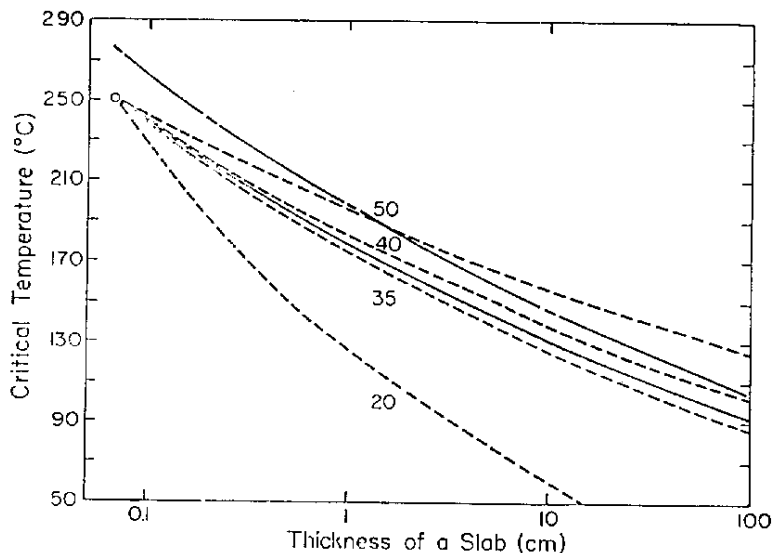

(benzenetrifuroxan) that has an experimental critical temperature of 250° C as a 0.6-mm-thick slab. An infinite number of compensating pairs of Es and Zs will predict the experimental  $T_c$ , but only the *correct* set will predict the critical temperature for all sizes and shapes.

Some idea of accuracy requirements can be obtained from the values of the compensating pairs:  $E = 50$  kcal/mole,  $Z = 3.16 \times 10^{18} \text{ s}^{-1}$ ;  $E = 40$  kcal/mole,  $Z = 2.62 \times 10^{14} \text{ s}^{-1}$ ;  $E = 37.2$  kcal/mole,  $Z = 1.92 \times 10^{13} \text{ s}^{-1}$ ;  $E = 35$  kcal/mole,  $Z = 2.44 \times 10^{12} \text{ s}^{-1}$ ; and  $E = 20$  kcal/mole,  $Z = 2.3 \times 10^6 \text{ s}^{-1}$ . All of these curves go through the single experimental  $T_c$  point, but only the 37.2 kcal/mole curve predicts  $T_c$  for all sizes and shapes. The upper solid curve that completely misses the experimental point is calculated from  $E = 37.2$  kcal/mole and  $Z = 4.11 \times 10^{12} \text{ s}^{-1}$ . It would give erroneously safe predictions for the material. It is the curve that was obtained from an experimental determination of E and Z. We were never able to get accurate measurements, because BTF is remarkably sensitive to confinement and is incompatible with almost everything (including sample holders).

***The fact that kinetics constants can not always be determined with acceptable accuracy makes it important to have at least one independent method for the determination of critical temperatures to check predictive models.***

The time-to-explosion test described above can be used to test predictive models.

## **Determination of Chemical Kinetics Constants for Use in Thermal Hazard Predictive Models:**

As discussed above, the accuracy of the kinetics constants is critical. We have found constants determined by DTA, ARC, or time-to-explosion alone to be too inaccurate for safety purposes.

Several calorimetric methods have been used for the determination of kinetics constants. Several

can be found in the literature that give good results, but we believe that the method that gives the most information on decomposition complexity and is the most generally applicable is that using a differential scanning calorimeter (DSC) in the *isothermal* (constant temperature) mode.

A DSC operates much like a DTA, and it looks very similar. Two sample holders are used, one for the sample and one for a reference; however, energy is partitioned between



them to keep their temperatures exactly the same: ***there is no heat flow between them.*** The energy required to keep the temperatures the same is the quantity measured. If the sample melts, energy is supplied to the sample to keep its temperature the same as the reference. If the sample decomposes exothermically, energy is supplied to the reference to keep its temperature the same as the sample. The energy measured *is* the energy of the transition or reaction. The measurements are quantitative.

A number of methods have been published that use the DSC in a temperature-scanning mode. None of them can be used with complex reactions to give sufficiently accurate kinetics constants for hazards predictions.

When the DSC is operated at constant temperature, a record is obtained of the rate of energy evolution as a function of time.

The figure shows isothermal DSC rate curves for several different types of energetic materials, as follows: 1) Comp B (65/35-RDX/TNT), 2) a high energy rocket propellant, 3) HMX, and 4) pure TATB.

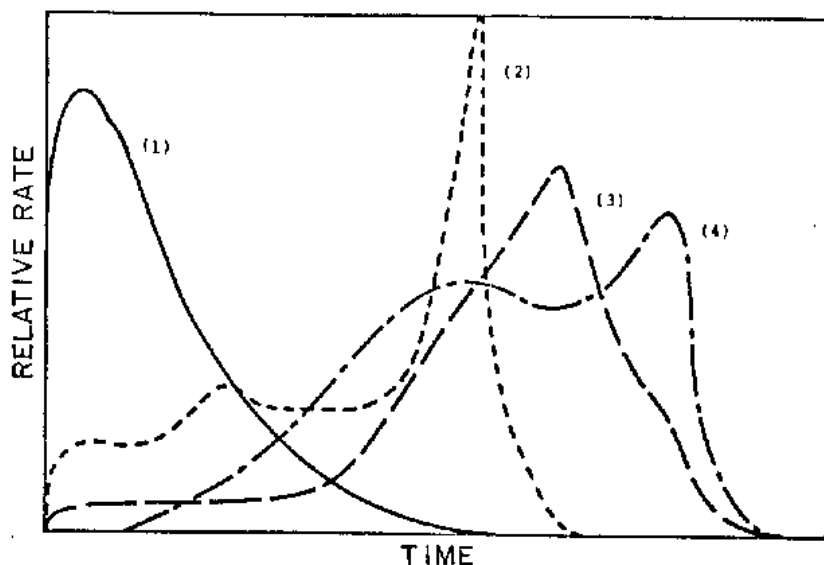

It can be seen that rate processes are very much different for the different materials. Use of assumed rate laws could lead to hazardously wrong predictions.

Reaction rate and amount of reactant(s) are the fundamental data required for any kinetics study. All of the values required can be obtained from an isothermal DSC rate curve.

### Isothermal DSC Kinetics Determinations:

An isothermal rate curve obtained from a 3-mg sample of TATB (1,3,5-triamino-2,4,6-trinitrobenzene) at 636K is shown in the figure to illustrate the method used to obtain kinetics constants.

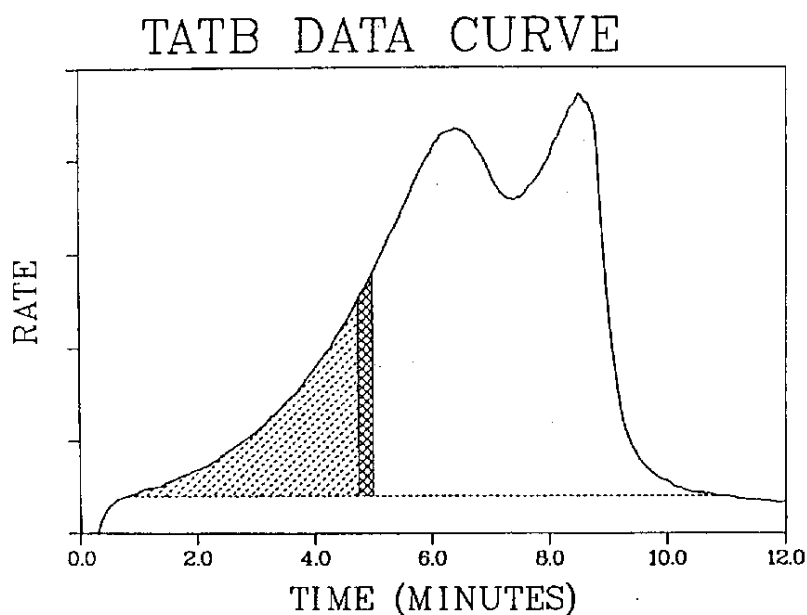

- Total Area, A
- ▨ Partial Area, a
- ⊠ Change in Area,  $\Delta a / \Delta t$



The fraction decomposed at any time ( $\alpha$ ) can be calculated from:

$$\alpha = \text{area to time } t / \text{total area} = a/A$$

The absolute rate at any time can be obtained from:

$$d\alpha/dt = \text{height above the baseline at } t / \text{total area} = h(t)/A$$

The quantitative rate of heat evolution (as measured with the DSC) is proportional to the rate of the (global) chemical reaction, as follows:

$$dq/dt = Qd\alpha/dt = kQf(\alpha),$$

where  $q$  is the measured heat flux,  $Q$  is the heat of reaction (for the specific reaction), and  $k$  is the chemical rate constant. However, although heat evolution and rate are proportional, **changes in mechanism associated with complex reactions can cause changes in heat of reaction ( $Q$ ) and the depletion function [ $f(\alpha)$ ]** as the reaction proceeds. **When mechanisms change during the course of a reaction, it is not valid to "linearize" the rate data for the entire process to obtain a single rate constant.**

A single depletion function that will model a specific part of a reaction is a necessary but not sufficient proof of a consistent mechanism. **VALID KINETICS CONSTANTS CAN BE OBTAINED ONLY FOR CONSISTENT REACTIONS.** Isothermal DSC often makes it possible to measure the kinetics constants for the different component reactions of a complex process, even those that operate as the rate-controlling components at lower temperatures.

It will be discussed below that a reaction regime that **both obeys a single depletion function and shows a constant kinetic isotope effect** represents a consistent reaction.

It is important to measure all of the component reactions. The low-rate, induction-time reactions will largely determine time to explosion; the most rapid reaction will be responsible for catastrophic self heating. It is seldom possible to make both time-to-explosion and critical temperature calculations with the same set of chemical rate constants.

The assumption is often made in the literature that the decomposition of an energetic material will obey a rate law of the following form:

$$d\alpha/dt = k(1 - \alpha)^n$$

where  $n$  is the "reaction order." When working with explosives and propellants, **that assumption is not often true.** It is necessary to analyze the data in such a way that consistent reactions can be identified and measured.

Autocatalytic-type processes (reactions in which the early rate increases with time and depletion at constant temperature) are common. Some causes for autocatalytic processes with explosives can be melting with decomposition (RDX, HMX, etc.), chemical autocatalysis (PETN, NC, NG, etc.), inhibition (stabilized propellants), and solid-state systems (nucleation-growth processes). The search for appropriate rate laws for the analysis of rate curves must include such systems. *The reaction products observed during the early (induction), intermediate (acceleratory), and late (decay) parts of an autocatalytic reaction are nearly always different.*

A first attempt to find appropriate rate laws can be made by making an "order plot." Once  $d\alpha/dt$  and a series of  $(\alpha, t)$  values have been obtained from the rate curves, they can be tested for simple rate laws ( $n \geq 0$ ). From the simple rate law above, you can see that a plot of  $\ln d\alpha/dt$  versus  $\ln(1 - \alpha)$  should give a straight line with a slope of  $n$  (the reaction order). Any curvature, discontinuity, or negative slope in the order plot indicates complexity in the reaction. **If negative slopes are observed, autocatalytic-type rate laws should be tested.**

A general autocatalytic rate law has the form:  $d\alpha/dt = k\alpha^p(1 - \alpha)^q$ .

When the peak of an autocatalytic rate curve occurs after 50% depletion,  $p > q$ .

TATB decomposes by a complex mechanism, and it provides a good example of the methods that allow analysis of such rate curves. TATB rate curves show an increasing rate early in the process, and the curve shows two distinct peaks: it is clearly complex.

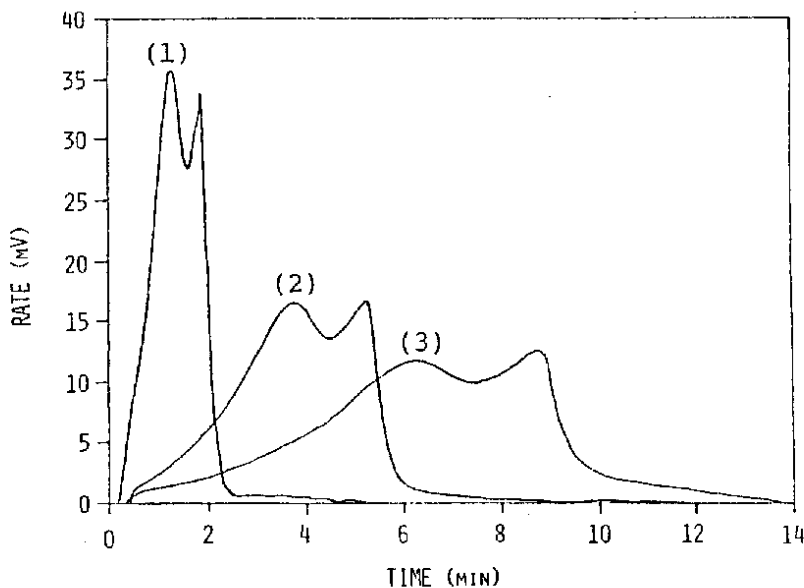

Isothermal DSC rate curves for production-grade TATB at the same weight and sensitivity: 1) 648 K, 2) 636 K, and 3) 630 K.

The TATB order plot shows that almost 60% has decomposed before the slope becomes positive.

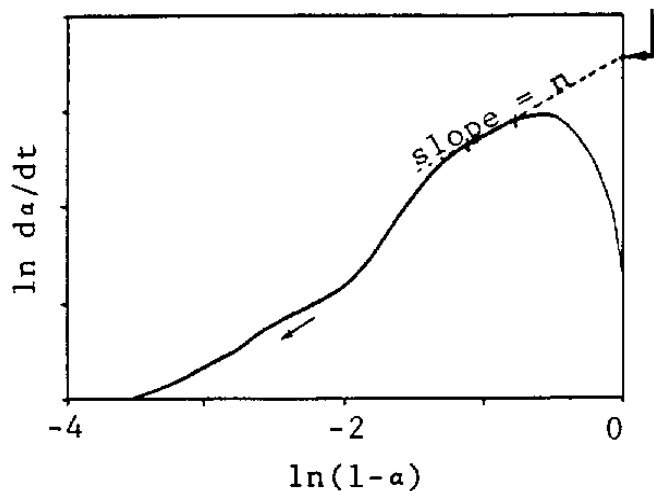

The intercept of any straight-line segment gives  $k$  for that segment. If the reaction is not truly normal, the  $k$  is meaningless.

However, a plot of the TATB rate data according to a simple autocatalytic law [ $d\alpha/dt = k\alpha(1 - \alpha)$ ] shows that a major part of the process can be modeled with such a law. In this type of plot, the slope is  $k$ , but the curve folds back on itself at  $\alpha(1 - \alpha) = 0.25$ .

The autocatalytic order plot for TATB shows that the slope of the early consistent reaction between  $\alpha = 0$  and  $\alpha = 0.5$  is reduced by deuterating the TATB. **There is a kinetic isotope effect (KIE).**

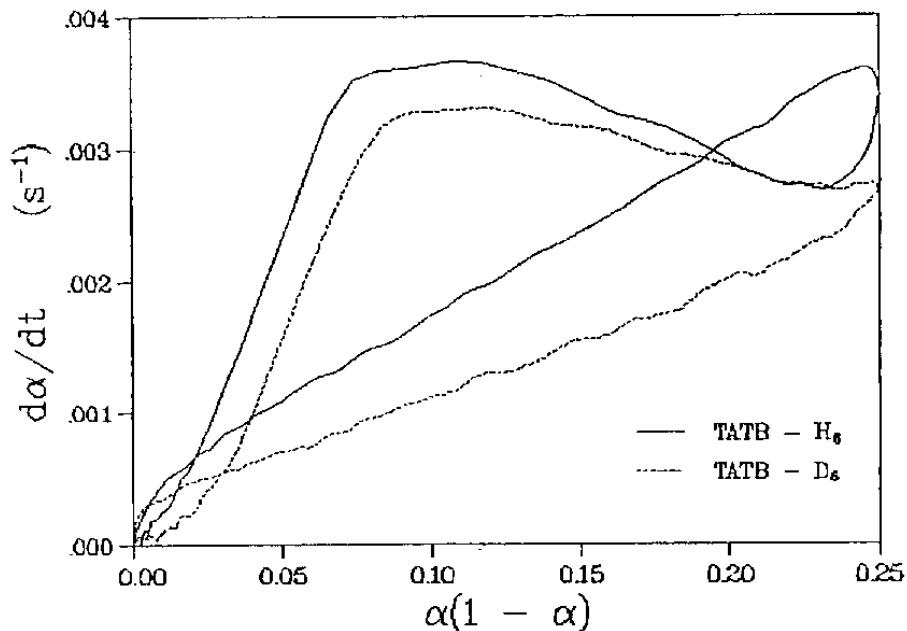

The KIE is constant through exactly the same range of depletion that showed the constant slope ( $k$ ). If a KIE is constant through a specific part of a complex decomposition, you can feel confident that a consistent component reaction has been identified. This is a time-consuming and expensive way to identify consistent reactions, but it may be the only positive way to unravel some nasty surprises by explosives.

Rate laws of all of the different types that can be expected have been observed in working with

energetic materials; however, most consistent reactions can be described according to one of the rate laws shown in the table.

### Some Rate Laws and their Integrals:

DEPLETION FUNCTION $f(\alpha)$	$\alpha$ max	$\dot{\alpha}$ max	$\int f(\alpha) = kt$
$(1 - \alpha)^0$	Const.	k	
$(1 - \alpha)$	0	k	$-\ln(1 - \alpha)$
$(1 - \alpha)^2$	0	k	$1/(1 - \alpha)$
$\alpha(1 - \alpha)$	0.5	0.25k	$-\ln\left(\frac{1 - \alpha}{\alpha}\right)$
$\alpha^2(1 - \alpha)$	0.667	0.149k	$-\frac{1}{\alpha} - \ln\left(\frac{1 - \alpha}{\alpha}\right)$
$\alpha(1 - \alpha)^2$	0.333	0.149k	$\frac{1}{1 - \alpha} - \ln\left(\frac{1 - \alpha}{\alpha}\right)$
$\alpha^2(1 - \alpha)^2$	0.5	0.0625k	$-\frac{1 - 2\alpha}{\alpha(1 - \alpha)} - 2\ln\left(\frac{1 - \alpha}{\alpha}\right)$

It is not usually necessary to go to such lengths as KIE measurements to prove that a useful consistent reaction has been identified. Rate constants (k) determined from straight-line portions of order plots can be used to calculate kinetics constants for the processes. Predictive models can be derived from the kinetics constants (E and Z), and the models can be tested by time-to-explosion tests.

The Arrhenius Law describes the effect of temperature on rate constants for consistent reactions, as follows:

$$k = Ze^{-E/RT}.$$

Therefore, a plot of  $\ln k$  versus  $1/T$  should give a straight line for each consistent reaction, and the slope of the straight line will be  $-E/R$ .

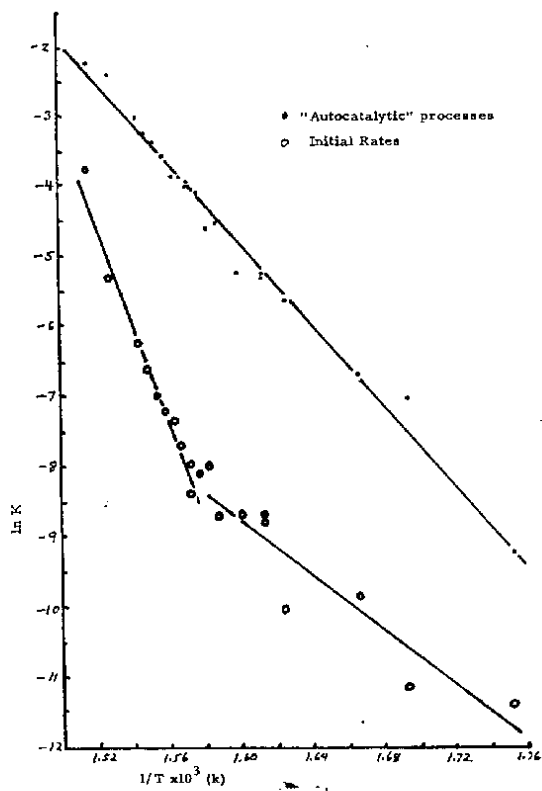

The Arrhenius plot for the TATB data is shown in the figure. The slope of the "autocatalytic process" gives an activation energy ( $E$ ) of 59.1 kcal/mole and the intercept gives a  $Z$  of  $3.75 \times 10^{18} \text{ s}^{-1}$ .

With TATB, only the  $E$  and  $Z$  for the "autocatalytic" process can be used correctly to predict experimental critical temperatures. This is exactly what you would predict from the KIE results. They are, therefore, the constants to use for  $T_c$  versus size and shape predictions.

**Kinetics constants can usually be determined for explosives, even when the decompositions are complex, by using isothermal methods. The kinetics constants can be used in suitable reactive-heat-flow mathematical models (eg, the Frank-Kamenetskii or Semenov equations) to predict the critical temperatures ( $T_c$ ) for any size and shape of a specific explosive. The predictive models can be tested for accuracy against time-to-explosion tests.**

Some examples of explosives that have been studied by the above methods are shown in the table. The prediction for BTF did not agree with the experimental critical temperature; therefore, we know that incorrect kinetics constants were determined. It would be hazardous to use such a model for large-scale predictions.

**Experimental and Predicted Critical Temperatures (With values used for calculations):**

	$T_m$ (°C)		Values Used					
	Experimental	Calc	a (cm)	$\rho$ (g/cm <sup>3</sup> )	Q (cal/g)	Z (sec <sup>-1</sup> )	E (kcal/mole)	$\lambda \times 10^4$ (cal/cm <sup>2</sup> ·sec·°C)
HMX	253-255	253	0.033	1.81	500	$5 \times 10^{19}$	52.7	7.0
RDX	215-217	217	0.035	1.72	500	$2.015 \times 10^{18}$	47.1	2.5
TNT	287-289	291	0.038	1.57	300	$2.51 \times 10^{11}$	34.4	5.0
PETN	200-203	196	0.034	1.74	300	$6.3 \times 10^{19}$	47.0	6.0
TATB	331-332	334	0.033	1.84	600	$3.18 \times 10^{19}$	59.9	10.0
DATB	320-323	323	0.035	1.74	300	$1.17 \times 10^{15}$	46.3	6.0
BTF	248-251	275	0.033	1.81	600	$4.11 \times 10^{12}$	37.2	5.0
NQ	200-204	204	0.039	1.63	500	$2.84 \times 10^7$	20.9	5.0
PATO	280-282	288	0.037	1.70	500	$1.51 \times 10^{10}$	32.2	3.0
HNS	320-321	316	0.037	1.65	500	$1.53 \times 10^9$	30.3	5.0

When the predictive model needs further verification (as with explosives for a nuclear weapon), or when kinetics constants have been impossible to determine, we do large-scale testing at a firing site. The cheapest system we have tried involves 1-liter heating mantles. We put castable explosives (that melt well below the test temperatures) in 1-liter round-bottom flasks. Explosives that do not melt at the test temperatures are machined into 13-cm-diameter hemispheres. Thermocouples are placed in the center of the samples and at several positions in each mantle. Two hemispheres are joined to make a sphere. Temperature controllers are adjusted so that the hottest spot in each mantle controls its temperature. Recorders chart the temperatures of the mantles and sample. We shield the sample in a 6-foot-diameter high-tensile steel containment vessel. We heat the mantles as quickly as possible to the desired test temperature. The sample is left until it self heats. Times may be as long as several weeks when the test temperature is close to the critical temperature. Tests run below the critical temperature show an increase in the central temperature of the sample, but the temperature ultimately begins to drop. The explosive decomposes, but there is no ignition or explosion. Large-scale tests require considerable time --- and stable power sources.

**Kinetic Isotope Effects and Explosives Sensitivity:**

As discussed above, kinetic-isotope effects can be used to detect the specific functional groups involved in the elementary reactions of complex explosives decomposition processes. Isothermal kinetics methods must be used to correlate component reactions with specific reaction regimes. When component reactions can be identified at different temperatures, kinetics constants can be determined. Conditions for self heating to explosion or detonation can be calculated from the kinetics constants, and predictions can be tested against independent time-to-explosion measurements.

However, much more can be learned from KIE. Pressure effects on the elementary reaction can be explained in terms of transition-state theory. It can be shown that the rate depends on pressure according to the expression:

$$\left( \frac{\partial \ln k}{\partial P} \right)_T = - \frac{\Delta V}{RT}$$

where  $\Delta V$  is the volume of activation. The volume of activation is defined as the difference in molar volume between the reactants and the activated complex. Pressure applied to a system that has a positive volume of activation decreases the rate of the reaction; pressure applied to a system that has a negative volume of activation increases the rate.

The sign of the volume of activation can be determined from the magnitude of the KIE. In the case of TATB (above),  $k_H > k_D$ , and the ratio is 1.5. It is a "normal" effect, and it is a "primary" effect. The elementary reaction involves motion of the hydrogens. Isotope effects are determined by changes in the force constants describing motions at the position of isotopic substitution for the process leading from reactant to transition state (the "activated" state). A decreased force constant can be correlated with a normal isotope effect. When there is a decrease in force constant leading to activation, bond lengths will be greater in the transition state: **there will be a positive change in the volume of activation.**

TATB is recognized as an intrinsically "insensitive" explosive, and it has a positive volume of activation. All other factors being equal, an explosive with a positive volume of activation will be more difficult to initiate with a shock wave than an explosive with a zero or negative volume of activation. We have not had the opportunity to study other explosives as completely as TATB, but it has appeared that  $k_H < k_D$  for HMX during the decomposition in the liquid phase, and the ratio for PETN appeared to be nearly zero.

We propose that observations of KIE could make it possible to predict sensitivities. A long-range goal would be a quantitative model for "sensitivity."

## Compatibility:

Compatibility problems can be handled in exactly the same way as are pure explosives. A reaction regime will normally be found that corresponds to the reaction between the explosive and the additive. The stoichiometry of the reaction can be obtained from the rate curve or order plot. The rate curves must be evaluated with the correct rate laws.

Mixtures of explosives with metals often show a zero order rate law, especially when the metal is a catalyst for the decomposition of the explosive. This is because the reaction takes place at the surface of the metal, and the surface area of the metal does not change.

Note that lead is not a true catalyst for the decomposition of RDX and HMX; it takes part in the

reaction. Elemental lead is oxidized to plumbic oxide by the oxides of nitrogen produced by the nitramines, then plumbic oxide oxidizes formaldehyde (another decomposition product). The lower oxides on the surface of the lead are then re-oxidized by oxides of nitrogen. The lead particles do not undergo significant size changes, so the reaction is best described by a zero-order rate law. More energy is obtained from the overall reaction, making the system more hazardous.

Zero order is defined as the situation where  $d\alpha/dt = k(1 - \alpha)^0$ ; that is,  $d\alpha/dt = k$  (a constant). The rate does not change with time at any given temperature. The data must be evaluated with a zero-order rate law. Predictions can be made.

## Time to Explosion:

Time to explosion gets longer as systems get larger. Times to explosion of a few weeks have been measured at temperatures slightly above the critical temperature in 13-cm diameter spherical geometry at Los Alamos.

In view of the long times, it would appear to be safe to do some operations at temperatures above the critical temperature. Indeed, that is often done; however, factors that change time to explosion must be understood in complete detail. Slight changes in purity or composition, changes in crystal perfection (as defects caused by pressing), past history of a charge, and/or fabrication or formulation methods can cause major changes in time to explosion. **The changes can be very large and unexpected. WE STRONGLY RECOMMEND AGAINST HANDLING ENERGETIC MATERIALS ABOVE THE CRITICAL TEMPERATURE.**

## BIBLIOGRAPHY

### DTA:

G. Krien, *Explosivstoffe* 8, 205, August 1965.

R. N. Rogers, *Microchemical J.* 5, 91 (1961).

H. J. Borchardt and F. Daniels, *JACS* 79, 41 (1957). This is the first kinetics article on DTA.

H. E. Kissinger, *Analytical Chemistry* 29, 1702 (1957). Kissinger proposed his method for simple reactions only (clays). The method is often used for explosives, giving erroneous results.

### Review of Thermal Methods:

L. W. Collins and L. D. Haws, *Thermochimica Acta* 21, 1 - 38 (1977).

ASTM, *American National Standard*, ANSI/ASTM E698 - 79, pp. 1009 ff.



**Pyrolysis (EGD):**

R. N. Rogers, S. K. Yasuda, and J. Zinn, *Analytical Chemistry* 32, 672 (1960).

J. F. Baytos, "Evaluation of High Explosives by Pyrolysis," LA-3249, Los Alamos National Laboratory, December 1964.

**Combined Pyrolysis and Thin-Layer Chromatography:**

R. N. Rogers, *Analytical Chemistry* 39, 730 (1967).

R. N. Rogers and L. C. Smith, *J. Chromatography* 48, 268 (1970).

**Vacuum Stability:**

MIL-STD-286B, 20 December 1975, Method 403.1.3.

J. F. Baytos, LAUR-84-1333, Los Alamos National Laboratory, June 1984.

J. F. Baytos, "High-Temperature Vacuum Thermal Stability Tests of Explosives," LA-5829-MS, Los Alamos National Laboratory, January 1975.

**Taliani:**

MIL-STD-286B, 1 December 1967, Method 406.1.2.

**Critical-Temperature Predictive Models:**

A. G. Merzhanov and V. G. Abramov, *Propellants and Explosives* 6, 130-148 (1981). A review of models.

D. A. Frank-Kamenetskii, *Diffusion and Heat Transfer in Chemical Kinetics*, Plenum Press, New York, NY (1969).

N. N. Semenov, *Chemical Kinetics and Chain Reactions*, Oxford University Press, London (1935).

**Thermal-initiation Testing:**

J. Zinn and C. L. Mader, *J. Applied Physics* 31, 323 (1960).

J. Zinn and R. N. Rogers, *J. Phys. Chem.* 66, 2646 (1962).

R. N. Rogers, *Thermochimica Acta* 11, 131 (1975).

D. L. Jaeger, LA-8332, Los Alamos National Laboratory, August 1980. This reports a critique on the ODTX.

### **Heat-Flow Calorimetry:**

J. L. C. Van Geel, *Ind. And Eng. Chem.* **58**, 24 (1966).

### **DSC Kinetics Methods:**

R. N. Rogers and L. C. Smith, *Thermochimica Acta* **1**, 1 (1970). This shows some of the problems with programmed-temperature kinetics methods.

R. N. Rogers, *Analytical Chemistry* **44**, 1336 (1972). Discusses isothermal rate constants.

R. N. Rogers, "Differential Scanning Calorimetric Determination of Kinetics Constants of Systems that Melt with Decomposition," *Thermochimica Acta* **3**, 437 (1972).

R. N. Rogers and G. W. Daub, "Scanning Calorimetric Determination of Vapor-Phase Kinetics Data," *Analytical Chemistry* **45**, 596 (1973).

R. N. Rogers and G. W. Daub, "Determination of Condensed-Phase Kinetics Constants," *Thermochimica Acta* **9**, 855 (1974).

A. A. Duswalt, "The Practice of Obtaining Kinetic Data by Differential Scanning Calorimetry," *Thermochimica Acta* **8**, 57 (1974).

R. Bruce Cassel, "ASTM Method of Testing for Determining the Arrhenius Kinetic Constants for the Screening of Potentially Hazardous Materials," *Perkin-Elmer Thermal Analysis Application Study* **28** [Pittsburgh Conference Paper No. 688, 1979].

### **Complex Reactions, KIE:**

R. N. Rogers, J. L. Janney, and M. H. Ebinger, *Thermochimica Acta* **59**, 287-298 (1982).

### **When All Else Fails (and you still have to make a prediction):**

R. N. Rogers, J. L. Janney, and N. P. Loverro, *Journal of Energetic Materials* **2**, 293-330 (1984).