

FMFRP 12-43

**Professional Knowledge Gained
from Operational Experience in
Vietnam, 1969, Special Issue,
Mines and Boobytraps**



U.S. Marine Corps

PCN 140 124300 000

DEPARTMENT OF THE NAVY
Headquarters United States Marine Corps
Washington, DC 20380-0001

20 July 1989

FOREWORD

1. PURPOSE

Fleet Marine Force Reference Publication (FMFRP) 12-43, *Professional Knowledge Gained from Operational Experience in Vietnam, 1969, Special Issue, Mines and Boobytraps*, is published to ensure the retention and dissemination of useful information which is not intended to become doctrine or to be published in Fleet Marine Force manuals. FMFRPs in the 12 Series are a special category of publications: reprints of historical works which were published commercially or by the U.S. Government Printing Office and are no longer in print.

2. SCOPE

This reference publication complements existing training manuals on small-unit tactics, patrolling, weapons, mines and boobytraps, and leadership. Written by a multitude of Marines during the Vietnam War, this volume is an excellent compendium of lessons to be learned from the Marine Corps' experience in 1969. It is enthusiastically recommended to all junior officers, SNCOs, and NCOs who will profit from the principles presented.

3. CERTIFICATION

Reviewed and approved this date.

BY DIRECTION OF THE COMMANDANT OF THE MARINE CORPS



M. P. SULLIVAN

Major General, U.S. Marine Corps
Deputy Commander for Warfighting
Marine Corps Combat Development Command
Quantico, Virginia

DISTRIBUTION: "119"

MINES AND BOOBYTRAPS

CONTENTS

<u>SECTION</u>	<u>PAGE</u>
I ENEMY MINE WARFARE	
Introduction.	1
Enemy Doctrine.	3
Enemy Sources of Supply	3
VC Mine Factories	5
Enemy Tactics	6
II COUNTERMEASURES	
Nontactical Countermeasures.	9
Tactical Countermeasures	13
Individual Countermeasures	15
Immediate Action to Take	
When and After an Explosive	
Device is Tripped.	22
Unit Training.	23
III ENEMY MINE INDICATORS	
IV ENEMY MINES AND BOOBYTRAPS	
Explosive Antipersonnel	
Devices.	39
Nonexplosive Boobytraps.	48
Antitank and Vehicle Mines	56
Antihelicopter Mining.	66

SECTION I

ENEMY MINE WARFARE

INTRODUCTION

The history of mine and boobytrap warfare is almost as long as the history of war itself. Although these devices were once considered an unfair and cowardly manner of fighting an enemy, nations continued to develop and employ mines and boobytraps because they provided an effective and simple means of inflicting casualties upon an enemy force.

During the war with France, 1946-1954, the Viet Minh used improvised explosive mines and boobytraps effectively against the French forces. The VC/NVA have continued to improve upon these techniques and are employing mines and boobytraps as an effective weapons system against free world military forces in SVN today. The number of Marine casualties, perhaps better than any other example, illustrates how effective the enemy is with these devices. Marines landed in force in SVN during March 1965 and during the first months of fighting approximately 65-75 percent of all Marine casualties were caused by mines and boobytraps. Much has been learned about the enemy's methods of employing mines and boobytraps since March 1965, but despite this knowledge, Marines, at an alarming rate, continue to become casualties as a direct result of enemy mines and boobytraps. During 1968, 37.7 percent of all Marine casualties were caused by the accidental detonation of a mine or boobytrap. In other words, more than one of every three Marines killed or

wounded in SVN becomes a casualty as the result of a mine or boobytrap. Although a great many detection means, ranging from intricate electronic devices to specially trained dogs, have been developed, experience has shown that an alert Marine, aware of what to look for and where to look, is the most effective detection device.

The information contained in this book is intended to make each Marine aware of the ways which the VC/NVA use mines and boobytraps and to describe the means to effectively protect one's self and unit from these devices. To aid in this objective, mines and boobytraps frequently used by the VC/NVA are identified and described.

Study this issue; the information in it can save lives -- yours and your fellow Marines'.



ENEMY DOCTRINE

Although modified by past guerrilla warfare experience in Vietnam, VC/NVA mine warfare doctrine continues to closely parallel that of the Chinese Communist Army. Extensive deliberate minefields have not been encountered in Vietnam. Rather, the enemy employs mines singly or in clusters to achieve his purposes.

In areas occupied and protected by free world forces, the enemy employs mines to delay and disrupt the use of roads and paths and to cause the allies to divert forces to guard and clear those routes. In addition to the threat to military traffic and lawful civilian movement, the free world personnel and equipment employed in patrolling the roads and in detecting and removing mines are prime targets.

In contested areas where friendly offensive operations or patrol activities are conducted, the enemy employs mines and boobytraps to inflict casualties, delay and channelize movement, and damage or destroy equipment.

ENEMY SOURCES OF SUPPLY

The enemy uses a very limited number of modern machine-produced mines. The majority of enemy mines are handmade by the VC using U.S. duds, discarded ammunition and equipment, and materials thrown away by U.S. forces as trash. Ninety percent of all the material in enemy mines and boobytraps is of U.S. origin (see fig.1). Of all the explosive devices produced locally in VC mine factories, 95 percent are anti-personnel boobytraps.

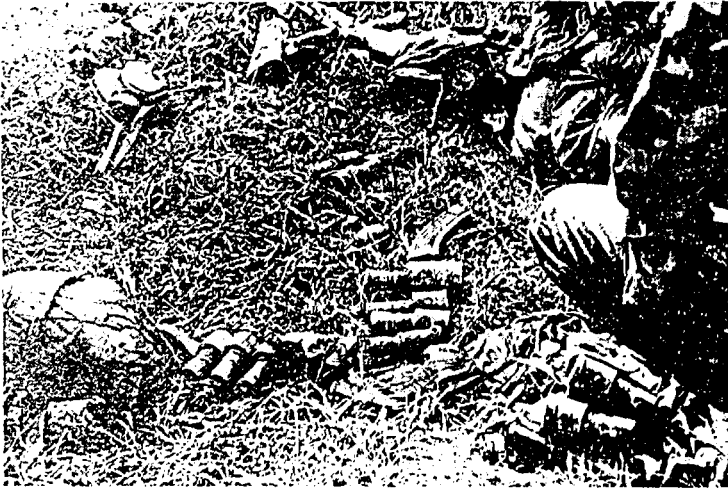

Figure 1.--Enemy equipment captured by Marines on sweep operations in ICTZ. Note US M-26 grenade in center of picture. Other grenades are locally produced using C-ration cans.

All dud ammunition is a source of enemy supply. After airstrikes and artillery and mortar missions, enemy salvage teams make sweeps to collect duds. Lighter ordnance is carried away to preparation areas; large bombs and projectiles are broken down and stripped on the spot. In some cases the larger duds are rigged as boobytraps where they have fallen. This is especially true when the enemy feels the strike or fire mission was a preparation for an infantry attack.

However, dud ammunition is not the only source of enemy supply. Carelessly discarded ordnance of all sizes and in any quantity is collected by enemy salvage teams. Mortar rounds, rockets, LAAW's,

grenades, and small arms ammunition abandoned to lighten the load (or improperly secured and lost by fast-moving Marines) have value as the explosive element in boobytraps. Even a single M16 round ejected to clear a stoppage can be used by the enemy.

Additionally, materials discarded as trash and improperly destroyed such as ration, ammunition, beer and soda cans, batteries, waterproof packaging materials, bandoliers, etc., provide the enemy a valuable source of supply to support his mine warfare operations. These items have, on numerous instances, been employed successfully against Marines and their equipment. Thorough police of friendly positions upon departure and complete destruction of trash are mandatory to deny the enemy this source of supply.

VC MINE FACTORIES

Primitive VC mine factories are usually located in the areas they supply. Great care is taken in the camouflage and dispersal of these facilities. Usually constructed underground, effort is made to disperse the workshops and storage throughout a series of tunnels. These limit destruction by working accidents or free world force artillery, air and naval gunfire and protect against discovery. As important as concealment of the mine factory, is the mobility of its personnel and equipment. Even while the mine factory is being settled in one position, new positions are being prepared for rapid displacement. Rarely does a mine factory

remain in one place any longer than a few weeks. There is no distinct pattern of movement. Factories have been known to return to previous positions even after that position has been discovered and destroyed by Marine forces.

NVA-trained engineers provide the skilled nucleus for the enemy mine factories, but supervision and labor are primarily VC. The typical output of a local VC mine factory is about 135 mines and explosive devices per month.

ENEMY TACTICS

ANTITANK AND ANTIVEHICULAR MINING

As we improve in our ability to detect mines, the enemy counters with new twists such as increased use of boobytraps attached to a basic mine to create casualties among mine-clearing personnel; larger mines buried deeper with reduced activation pressure; and pressure electric detonators with offset devices to explode mines under vehicles. Command-detonating mines are normally used in densely populated areas and pressure-type devices in less populated sections. The heaviest mining is along lines of communications near fixed installations.

The enemy makes every effort to avoid repeating practices which, when analyzed, could indicate a pattern. Therefore, the VC/NVA doctrine stresses where to use mines, not how. Listed below are a few of the kinds of places where enemy antitank and antivehicular mines may be found:

- Road junctions and the areas in the vicinity of the road near the junction,

with all the mines set to detonate simultaneously.

- Bridges and the approaches 5 to 15 meters from the bridges.

- Old wheel and tread tracks in the road, with care taken to duplicate the track after mine emplacement.

- Underneath roads, tunneling in from the shoulders.

- Potholes in the road.

- Areas recently cleared by free world military forces. The enemy replaces the mines that have been taken out.

ANTIPERSONNEL MINES AND BOOBYTRAPS

Enemy tactics in emplacing antipersonnel mines and boobytraps differ from those used in antitank and antivehicular mining only by where they put them. Locations most commonly used by the VC/NVA to emplace antipersonnel mines and boobytraps are:

- Narrow passages.
- Paddy dikes.
- Trail junctions.
- Hedgerows and tree lines.
- Tunnels and caves.
- Fence lines and gates.
- Tree branches overhanging trails.
- Likely CP sites.
- High ground and ridgelines.
- Shady areas.
- Stream fords.
- Wells and natural watering points on streams and rivers.
- Likely helicopter landing zones.

▶ Remember: Any place a Marine frequently walks, takes cover, rests, or draws water is a likely location for enemy antipersonnel mines and boobytraps.



SECTION II

COUNTERMEASURES

Countermeasures are those actions, both tactical and nontactical, that can be taken by units and/or individual Marines which reduce the mine and boobytrap threat. Countermeasures decrease the enemy's ability to emplace mines and boobytraps or limit their effectiveness if they are emplaced.

NONTACTICAL COUNTERMEASURES

The most effective way to counter the enemy's mine and boobytrap threat is to destroy this threat at its source; i.e., the elimination of the VC/NVA mine and boobytrap factories and the sources of supply for these factories.

Every effort must be made to locate existing enemy mine and boobytrap factories and to determine likely locations for future factory sites. Hoi Chanhs, POW's and captured documents must be carefully processed because, with skillful handling, they provide vital information on factory location sites. Once found, existing factories and future locations must be made unusable.

More important than neutralizing the enemy's mine and boobytrap factories, is the denial to the enemy of the source of supply with which he operates these factories; i.e., unexploded U.S. ordnance, discarded equipment and improperly destroyed trash. The fact that U.S. ordnance and salvageable trash falls into enemy hands can be traced to several factors:

◇ Unexploded Ordnance

The first factor and an important source of unexploded ordnance for the enemy is provided by the free world military force's employment of air, artillery and naval gunfire support. Some ordnance items fail to detonate, become a "dud" and provide a potential mine or boobytrap. All Marines who employ fire support should consider this fact in the employment of supporting arms, and be careful not to call for fires in excess of what is required to accomplish the mission.

◇ Abandoned Munitions

The second factor, another important source of explosive materiel supply for the enemy's mine and boobytrap operations, is abandoned or lost munitions. The following examples, if allowed to occur, will assist the enemy in his efforts:

- Overstockage. A unit overstocks ammunition and then is required to move on short notice with only a basic load. The remaining ammunition is left on the abandoned position.

- Ammunition Handling Procedures. A unit attempts to turn in excess ammunition to an ASP (ammunition supply point) and is refused due to inefficient disposal procedures.

- Abuse of Ammunition. A unit discards ammunition considered unserviceable because of dirt, tarnish, mud or other avoidable conditions or minor imperfections.

- Loss in Transit. A helicopter sling breaks on an ammunition resupply mission and all or a portion of the load is scattered across the countryside.

◇ Improperly Destroyed Trash

The last factor, but far from least important to the enemy's mine and booby-trap program, is his source of supply from friendly trash. All items considered unusable by free world forces must be completely destroyed or properly disposed of. Figure 2 shows one example of the results of an improperly policed friendly area of operations. Discarded C-ration/soda cans are also commonly used in a type of booby-trap which is constructed with an M26 grenade. The safety pin is removed and the grenade is put in the can. When the can is disturbed, the grenade slips out, the spoon pops and the grenade detonates.

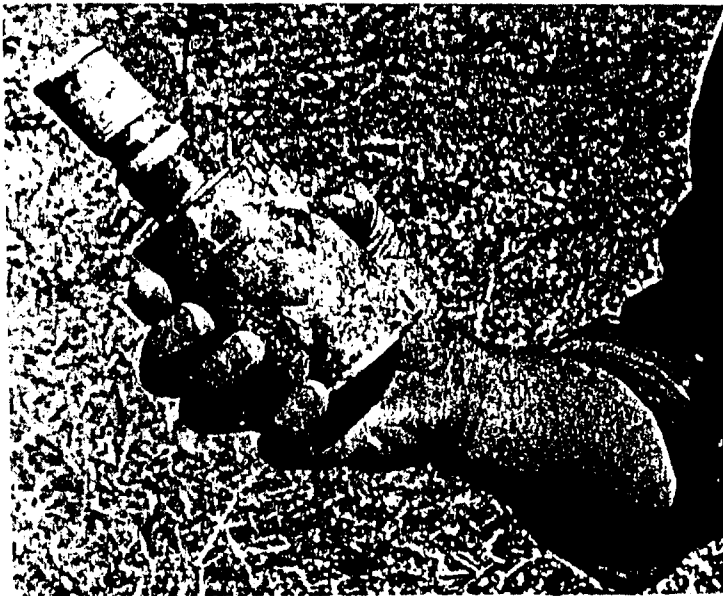

Figure 2.--Shown is a VC grenade made from locally available materials including a carelessly discarded "Coke" can.

The VIP (Volunteer Informant Program) has proved to be an increasingly effective countermeasure to the enemy's mine and boobytrap efforts. This program rewards Vietnamese individuals who turn in dud and abandoned munitions. Continued emphasis on this program will significantly decrease the enemy capacity to employ U.S. ordnance against free world forces. (See fig. 3.) During one period, 188 of 259 payments in the III MAF area were made to children who turned in explosives suitable for the manufacture of boobytraps. To ensure that the effectiveness of VIP reaches its full potential, it is the responsibility of every individual Marine and each Marine unit to give VIP their complete support.



Figure 3.--Shown here is the VIP (Volunteer Informant Program) in action. Articles on ground have been turned in to Marines by local villagers.

TACTICAL COUNTERMEASURES

Tactical countermeasures employed by Marine units are very effective in reducing the enemy's capability of emplacing mines or boobytraps if such countermeasures are aggressively planned and executed. Unit commanders have several tactical measures at their disposal, including the employment of sophisticated electronic devices. They are:

- Employing portable ground radar and seismic intrusion devices.
- Maintaining a constant physical presence throughout the TAOR to include outposting of key roads. This is the most effective tactical countermeasure, but sometimes difficult to achieve because of the number of Marines required to ensure good coverage.
 - Conducting aggressive patrolling.
 - Conducting reconnaissance patrols to verify S-2 intelligence reports.
 - Employing scout-sniper teams.
 - Conducting small unit cordon and search operations in coordination with Vietnamese units/police.
 - Employing H&I fires over roads or over specific areas.
 - Employing small stay-behind patrols dropped off unnoticed from units passing near a road.
 - Paving or oiling dirt roads.
 - Patrolling and outposting on and near roads.
 - Employing Kit Carson Scouts. Using the native ability of the Kit Carson Scouts, coupled with their knowledge of the area of operations and VC activities, can prove highly useful in locating devices. During

October 1968, Kit Carson Scouts found 229 mines and boobytraps in the III MAF area.

●Scout Dogs. Using specially trained dogs (see fig. 4.) to detect the scent left by the individual emplacing a mine or boobytrap. This scent is detectable 1-4 days after emplacement. Since boobytraps are generally emplaced shortly after initiation of friendly operations, the chance of discovery by dogs is good. A trained dog will use his vision to detect tripwires and unnatural elements, and his hearing to detect sound waves created by tripwire vibration. Many dogs detect a tripwire when it touches the body hair of their forelegs or chest. Most are agile enough to back away before it is tripped. Of 119 dogs killed in SVN since January 1967, only seven were killed by boobytraps.



Figure 4.--Specially trained dogs such as the one shown here have proven extremely valuable in detecting enemy mines and boobytraps.

INDIVIDUAL COUNTERMEASURES

Individual countermeasures are those measures each and every Marine can take to diminish the effectiveness of a mine or boobytrap device which has been emplaced, and is found or is accidentally detonated. This can be accomplished through physical protective measures, detection and destruction measures, avoidance of explosive devices, and through application of immediate action when an explosive device has been accidentally detonated.

▷ Physical Protective Countermeasures

The individual Marine can take these steps to reduce the effectiveness of enemy mines:

- Wear body armor and helmet.
 - Sandbag vehicle flooring. When possible, place a heavy rubber mat over sandbags to reduce secondary fragments such as shrapnel, sand, stones and pieces of sandbag.
 - Keep arms and legs inside vehicles to achieve maximum protection from sandbags.
 - Maintain proper distance from other personnel.
 - Don't travel alone.
 - Don't pick up or touch what appear to be attractive "souvenirs". The VC/NVA prey upon the natural curiosity of Marines and their desire to take home a souvenir.
- ▶ **Beware:** That "souvenir" is most likely a boobytrap.

▷ Detection Countermeasures

Once emplaced, a mine or boobytrap must be found before it causes multiple casualties through accidental detonation by

a Marine. Unfortunately, too many boobytraps are discovered only after they explode. It is imperative that detection techniques be stressed. Detection may be by:

• Visual inspection. At present, the best mine and boobytrap detector in the Marine Corps is an alert and observant Marine. Each Marine must know the areas in which boobytraps and mines are normally found and be alert for things which "just don't look right." Examples are:

• Mud smears, mudballs, dung, or a board on the road.

• Apparent road repair, new fill or paving patches, ditching or culvert work.

• Wires leading away from the side of the road.

• Tripwires across the trails; along shoulders of roads at likely ambush sites; across the most accessible route through dense vegetation; at fords, ditches and across rice paddy dikes.

• Terrain features which do not appear natural. Cut vegetation dries and changes color; rain may wash away covering material and cause an explosive device to sink leaving a surface depression; a covered device may appear as a mound.

• Suspicious items in trees, branches, or bushes.

• Markings used by VC/NVA to indicate the location of a mine or boobytrap.

• Probing. Suspicious spots must be carefully probed with a probe or bayonet.

• Mine detectors. Mine detectors are designed to assist the individual Marine in a detailed, deliberate sweep of a specific area, usually a road. Particular

attention must be given to the time factors of the individual sweeping situation, since overhasty opening of a road can mean an ineffective sweep and quite possibly destruction or injury to vehicular traffic and personnel. The average sweep rate varies from almost nothing to about 5 m.p.h. depending, of course, on the proficiency of the team and the number of contacts encountered. In using detectors, certain considerations must be kept in mind:

- Graveled roads make it difficult for the AN/PRS-4 detector to discriminate between real and false targets.

- Metallic debris, such as can tops, small arms ammunition cases, and metal fragments from artillery rounds fired over roads at night to discourage mine laying, make it difficult for the AN/PI53 detector to discriminate between real and false targets.

- The tendency for the enemy to bury mines deeper than designed detection depths, and to deliberately plant metallic debris in the road, calls for additional caution in the use of detectors.

- Operator fatigue. Consideration must be given to the fatigue experienced by operators after 20 minutes of wearing detector earphones. This condition can be delayed to 1 or 2 hours by wearing earphones over the helmet so that 2 to 4 inches exist between ear and phone. This also permits the operator to hear a verbal alert for an ambush.

- Use of the Buddy System. This system is not only useful in training inexperienced Marines, but also provides an extra margin of safety to the individuals who employ it. Two Marines working together, in the same area, have the advantage of

increased detection capability, mutual reassurance, and shared knowledge.

◇ Destruction Countermeasures

Once detected, mines and boobytraps must be marked and/or destroyed in place by the discovering person or unit to prevent accidental detonation by a following unit or individual Marine. Considerations for destruction are:

- Mines and boobytraps should not be moved unless absolutely necessary and then only by qualified EOD or engineer personnel. Many boobytraps are themselves boobytrapped, and if disturbed will detonate the associated device.

- Explosive devices should be destroyed by engineers. If engineers are not available, then devices may be destroyed by selected qualified personnel within each unit.

- Mines and boobytraps may be destroyed or neutralized by use of grappling hooks, demolitions, and artillery fires. The LVTE linecharge and the LVTE with plow-shaped mine excavator (figs. 5 and 6) should be considered for use in areas of high mine density.

◇ Avoidance Countermeasures

Strict application of training and careful planning of movements through danger areas will enable unit commanders and individuals to reduce casualties by simply avoiding the explosive devices. The unit leader must analyze from the enemy's viewpoint each area through which he intends to move his men. He must ask himself the question, "If I were the enemy, where would I put the boobytrap?" This question can and should influence both administrative



Figure 5.--The LVTE firing its organic linecharge to clear mines.



Figure 6.--The LVTE with its plow-shaped mine excavator.

and tactical movements and is a factor to be considered in the scheme of maneuver during an attack. Some suggested means for avoiding mines and boobytraps are:

- Stay off trails, footpaths, cart tracks, or other likely routes of travel as much as possible. Vary routes used to villages and key terrain features. Use of the same route twice is an invitation to the enemy to employ boobytraps. Keep the VC/NVA guessing as to which route will be used next.

- Move where local inhabitants move. These people know the location of most mines and boobytraps and will avoid these areas. In a village, stay near the villagers and watch which buildings they use. Use Vietnamese as guides whenever possible. Have sufficient money on hand to pay for information on mine and boobytrap locations and support VIP.

- Avoid patterns. Constantly change direction of movement. Check times of departure and return of patrols to ensure, for example, that all daylight patrols don't return before supper and all night-time patrols depart after supper. Avoid the repeated use of the same bivouac areas.

- Maintain intervals of 15 meters between men and 100 meters between men and tracked vehicles. In view of the fact that the effective casualty radius of the M26 grenade is 15 meters, and that two or more casualties are suffered for each boobytrap grenade accidentally detonated, the maintenance of proper interval is most important.

- Move slowly. Rapid movement generates carelessness. A unit must be allowed sufficient time to move to its objective.

- At times the enemy will show themselves only when they want to be seen. When

pursuing the enemy, be especially alert for deliberately emplaced boobytraps on the axis of advance.

- Artillery and mortar fires near and in the area of operations will not only discourage boobytrap emplacement, but will also neutralize devices by sympathetic detonation, overturning and burying emplaced mines, and rupturing tripwires. Employment of these fires beside a road, before and during a road sweep, will discourage command detonation of road mines.

- At all times, a lightweight stick (bamboo) or a slender steel rod can be helpful if used to feel for tripwires.

- Mark detected mines and boobytraps so those following may avoid them.

- Helicopters can be used to extract a unit which finds itself in a heavily boobytrapped area.

- At times, the flanks of a road are boobytrapped out to 250 meters as an obstacle to road sweep security teams. Tanks, preceding the infantry, can detonate these boobytraps. When trafficability permits, tanks moving off and parallel to the road sweeps can also reduce tank road-mining incidents. Random selection of tank travel between road and adjacent terrain will keep the NVA guessing as to the actual route the tank will take.

- When on roads, stay in the well-used portion and off shoulders.

- Follow the tracks of the vehicle ahead. If there is no vehicle ahead, stay out of the ruts.

- Avoid holes, depressions, and objects lying on the road.

◆ Remember: A boobytrap too easily detected can be a ruse resulting in detonation of other explosive devices emplaced nearby.

Immediate Action To Take When and After
an Explosive Device Is Tripped

It is recognized that little reaction time exists once the detonation chain starts. The maximum delay for the M26 and foreign grenades ranges from 4 to 9 seconds. If the delay element has been modified, the minimum fuse delay can be less than 1 1/2 seconds. However, since the time available cannot be predicted, certain immediate action can assist in reducing casualties and the degree of personal injury.

◇ Immediate Action

FIRST: Be alert for the "pop" of the exploding cap, the tug of the tripwire, or the warning of another Marine.

SECOND: Sound a warning so that others may take cover.

THIRD: Drop to the ground immediately.

Immediate action is designed as an instinctive reaction based on minimum fuse delay. When using it also remember:

- Do not attempt to outrun the explosion. The 800 fragments of the M26 grenade have an initial velocity of over 5000 feet per second. During the available delay, however brief, an individual can best remove himself from the cone of the explosion by dropping to the ground. He must assume a minimum delay in every case.

- If possible, when dropping to the ground, present the smallest target to the force of the explosion by pointing the feet in the direction of the charge.

- All those nearby should drop to the ground when the warning is sounded.

- Do not immediately rush to the aid of Marines wounded by mines or boobytraps. Frequently there is a second boobytrap in the vicinity of the first. The man nearest each casualty should carefully clear his way to the wounded individual and render first aid. Under no circumstances should the unit leaders or others crowd near the wounded men.

- Conduct a brief but careful search for other explosive devices in the immediate vicinity before moving on.

- If a device is tripped and does not explode, follow the same immediate action and then blow it in place.

UNIT TRAINING

We have discussed preventive countermeasures, tactical countermeasures and individual countermeasures. Simply realizing that these countermeasures exist isn't sufficient. It is imperative that every Marine becomes knowledgeable of and proficient in the execution of the countermeasures discussed. This task can be accomplished through an aggressive and comprehensive unit and individual training program. Such training should emphasize:

- Wearing of helmets and body armor.
- Dispersion between men.
- Alertness.
- Visual detection techniques.
- Operation of electronic detection equipment.
- Demolition training which enables Marines to destroy explosive devices in place.
- Employment of the buddy system.
- Avoidance of patterns.
- Immediate action procedures and action to take subsequent to the detonation of an explosive device.



SECTION III

ENEMY MINE INDICATORS

If the enemy emplaces mines or booby-traps in the vicinity of villages or in areas where he moves or expects to move, he often indicates the location or direction of the explosive devices in some manner. The VC/NVA may not always follow the examples in this publication in absolute detail, but as a general rule, the indicators are usually found in a regular pattern such as sticks or stones in a line or sticks placed on or in the ground. This regularity of pattern is the danger signal (see fig. 7). Any arrangement of sticks and stones which appears unnatural indicates a strong possibility of the presence of

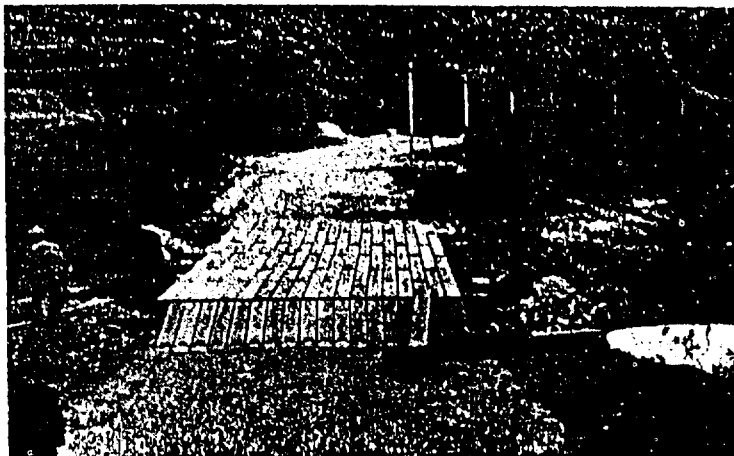
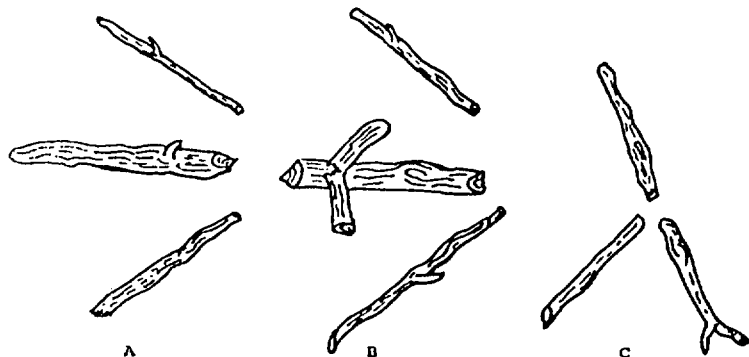

Figure 7.--Note the row of rocks on top of bridge beam at the foot of the bridge. This is typical of the warning signs used by the VC/NVA to warn of their mining activities.

mines and boobytraps. The illustrations which follow are examples of marking patterns indicating the presence of mines and boobytraps which have been encountered thus far in SVN.



ARROW MARKERS



A. Three sticks are placed on the trail in the form of an arrowhead. The important thing to remember is that the point of the arrow does not always point in the direction of the boobytrap. The symbol can only be considered as a means to identify an area as being boobytrapped.

B. A variation of the three-stick arrowhead shows a fourth stick. Again, no definite pattern has been established as to direction or the reason for the fourth stick (usually broken). But it does mean boobytraps in the area.

C. The "Y" arrangement is sometimes found farther down the trail from the arrowhead indicating the limit of the danger area. No pattern or specific distance has been established.

BAMBOO RECTANGLE MARKER

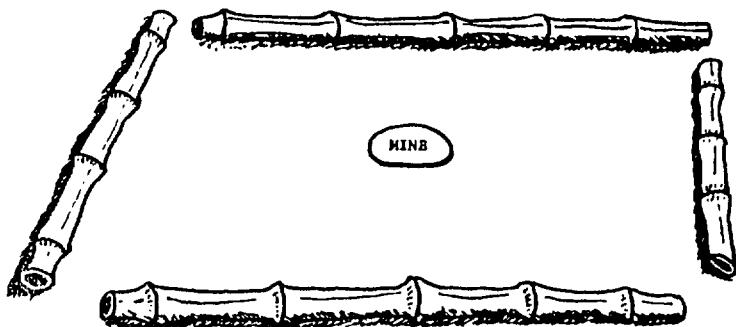

As shown, this marker usually indicates a boobytrap within the square. Most of these symbols found have been laid out with bamboo 18 to 42 inches in length.



BAMBOO MARKER

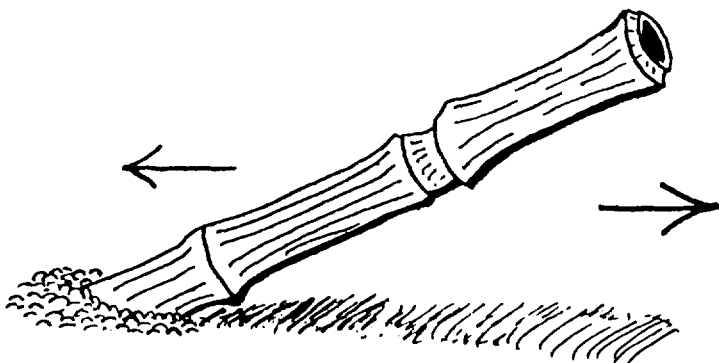

A piece of bamboo 6 to 8 inches long is stuck in the ground at an angle of 45 degrees. Generally, boobytraps can be expected along the axis of the bamboo in either direction.



BAMBOO TRIPOD MARKER

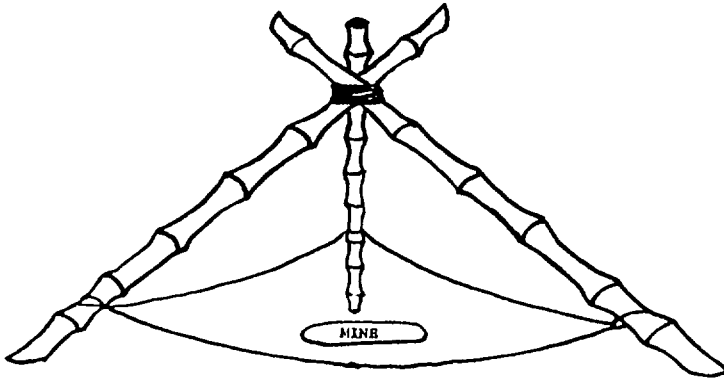

The bamboo tripod consists of bamboo, usually about 18 inches long, tied together to form a tripod. Wire, vines, cord or string is wrapped around the legs near the bottom to hold the tripod in place. This device has been found directly over punji pits, boobytraps, and mines.



BROKEN BUSH OR STICK MARKERS

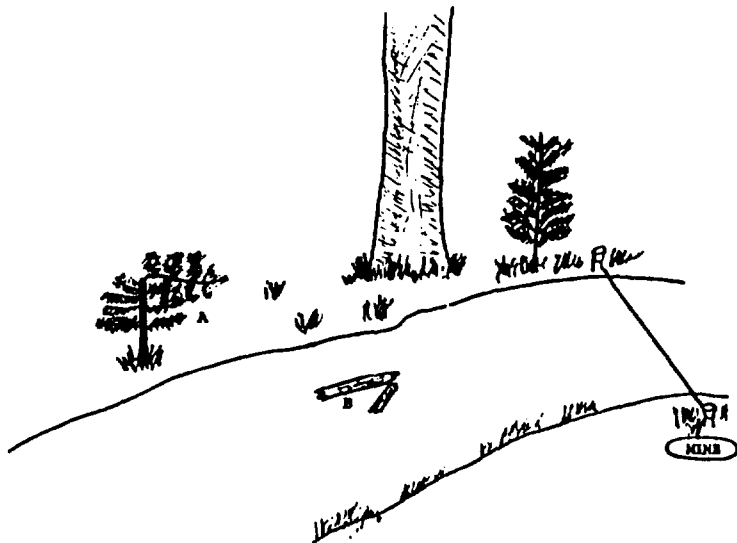

A. The enemy has been known to break the tops of small saplings and bushes pointing the broken part in the direction of the boobytrapped area. Usually mines and boobytraps are planted 50 to 100 meters from this marker.

B. A stick or length of bamboo broken at a right angle and lying across the road or trail may mean an enemy mine or boobytrap 200 to 400 meters ahead.



BANANA LEAF MARKERS

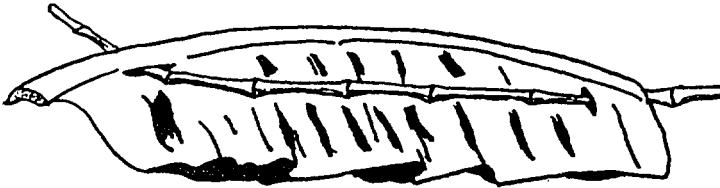

A banana leaf or other similar leaf is folded down the center with a thin stick approximately the thickness of a toothpick woven through in two places. In addition to marking mines, this may indicate an ambush area. There is no pattern as to location or distance of mines or ambushes from this marker.



PARALLEL STICK MARKER



Short sticks or lengths of bamboo laid parallel to a road or trail usually mean the road or trail is free of mines or boobytraps.



GROWING GRASS MARKER

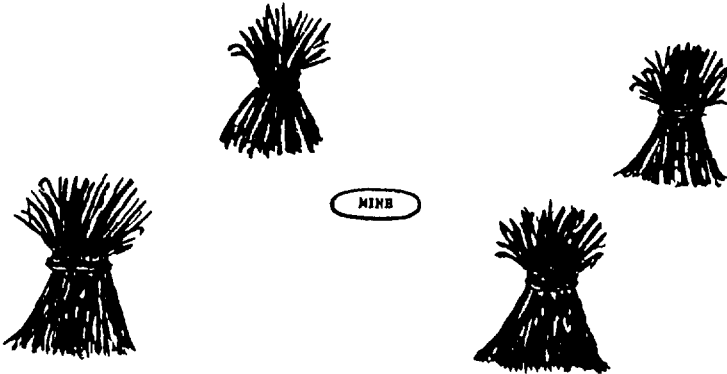

Growing grass is sometimes tied to form four growing sheaves of grass. The tied sheaves form a square of about 6 feet. The mine is buried or concealed in the center of the square.





TRAIL MARKERS

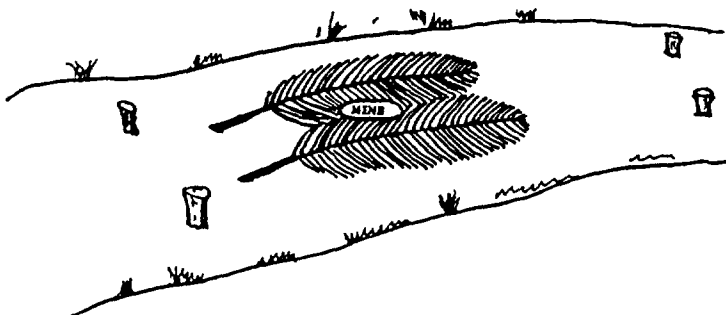

These devices have been used extensively together. The mine or boobytrap is placed (buried) under two large leaves. In front and to the rear, at no special distance, stakes are driven. The markers have also been used independently of each other at times.





FORKED-STICK MARKER

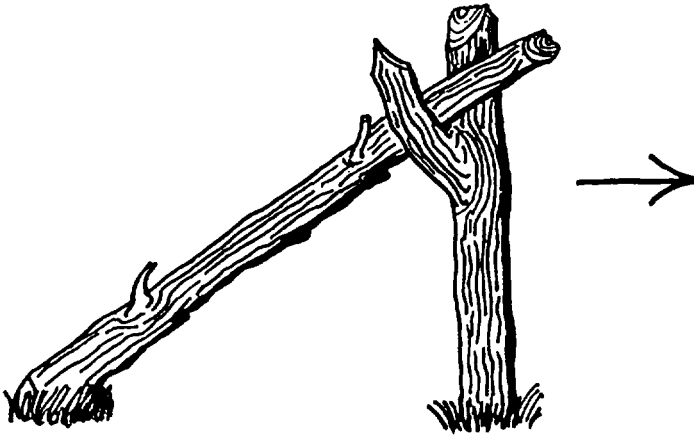

A forked stick is driven vertically into the ground and another stick is laid into the fork with the elevated end pointing to the danger area. Distance to explosive device is unknown. This sign may also indicate enemy direction of movement.





ROCK MARKERS



Various formations of rocks and small stones are used to mark boobytrapped areas. No pattern of distance or location has been established.





SPACED-STICK MARKER

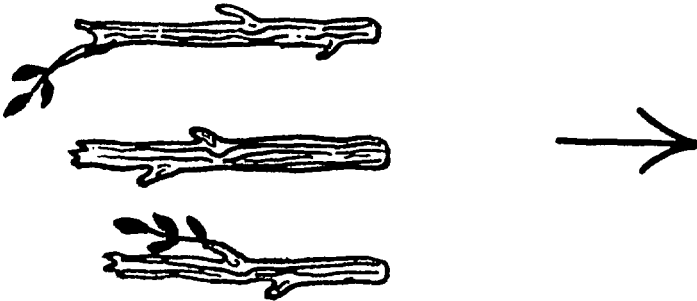

Three sticks, one on each side of a road or trail and one in the middle, usually mean the road is not to be used. A mine or boobytrap is usually 200 to 400 meters from the marker. Stones have been used in the same manner.





TRACK MARKER

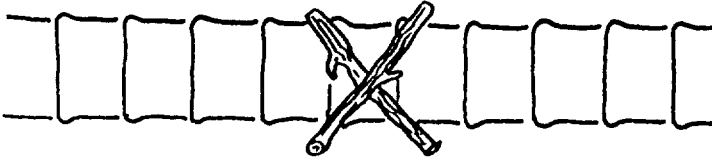
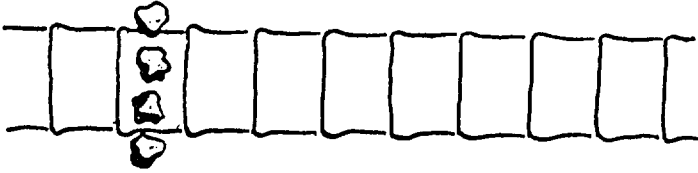

The enemy has capitalized on our habit of following old vehicle tracks by placing mines in these tracks. Mines are sometimes marked with crossed sticks or an arrangement of stones. The location of the mine in relation to these markers is unknown. The mine may be under the marker or up to 400 meters farther on.





STAKES WITH X-MARKER

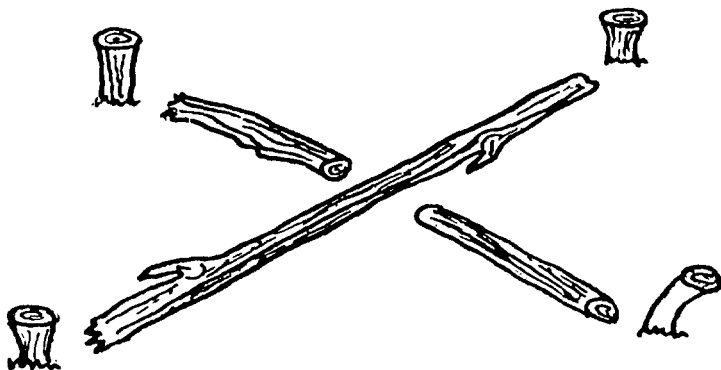

An M1A1 antitank mine with approximately 25 pounds of TNT was discovered under this marker. The mine had been marked with stakes at each corner and three sticks forming an "X" over the mine.





SECTION IV

ENEMY MINES AND BOOBYTRAPS

EXPLOSIVE ANTIPERSONNEL DEVICES

Mines and explosive boobytraps employed by the enemy against friendly personnel are limited in type and quantity only by the availability of explosive materials and the imagination of the enemy. Anything that can be made to explode and cause injury can be rigged as an anti-personnel mine or boobytrap.

Antipersonnel mines and explosive boobytraps are very successfully employed by the VC/NVA. Part of this success is because Marines are not familiar with the physical description of explosive devices normally employed by the VC/NVA, and thus fail to recognize them prior to accidental detonation.

The following illustrations represent some of the devices employed by the VC/NVA in SVN.





MUDBALL MINE

SUN-BAKED MUD OR CLAY
APPROX ½" THICK

SAFETY PIN
REMOVED

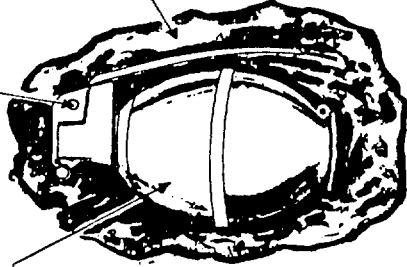

M26 HANDGRENADE

The mudball mine consists of a hand-grenade encased in sun-baked mud or clay. The safety pin (pull ring) is removed and mud is molded around the grenade. After the mud dries it holds the lever of the grenade in the safe position. The mudball is placed on trails or anywhere troops may walk. Stepping on the ball breaks the dried mud apart and releases the lever detonating the grenade. The U.S. M26 and M33 handgrenades have been the most commonly used grenades for this purpose although other lever-type grenades may be used.



TIN CAN ANTIPERSONNEL MINE

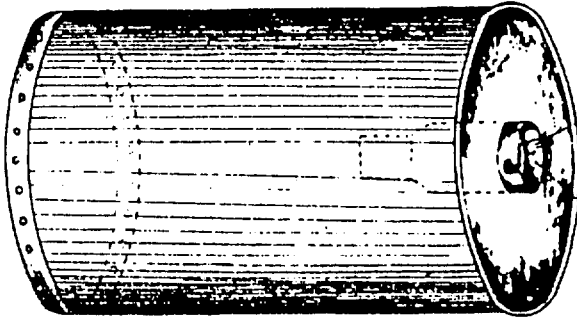

The tin can mine is constructed from sheet metal or any discarded metal container (C-ration, beer, or soft drink can). The firing device for the explosive is an improvised fuse with zero delay action. A handgrenade fuse may be used by removal of the delay element. The mine functions by a tripwire attached to the pull ring. Pressure on the tripwire pulls the pull ring, activating the mine in the same manner as a handgrenade.



CAST-IRON ANTIPERSONNEL
FRAGMENTATION MINE

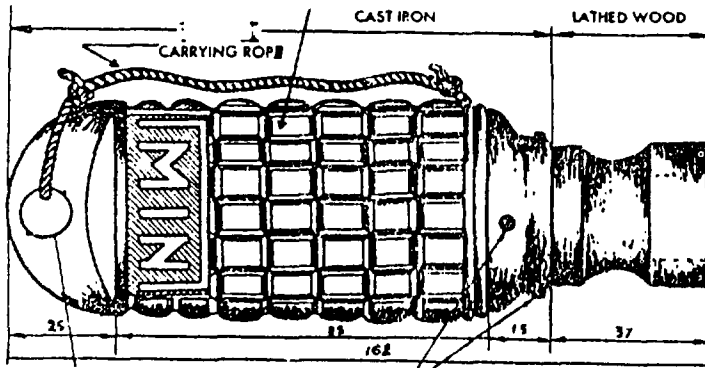

This mine, made of cast iron, resembles a stick handgrenade with a very short handle. The word "MIN" is often found cast into the body. The handle houses a pull-friction igniter. A tug on a trip-wire attached to the friction igniter will activate the fuse.





CHINESE COMMUNIST NO. 8
DUAL-PURPOSE MINE

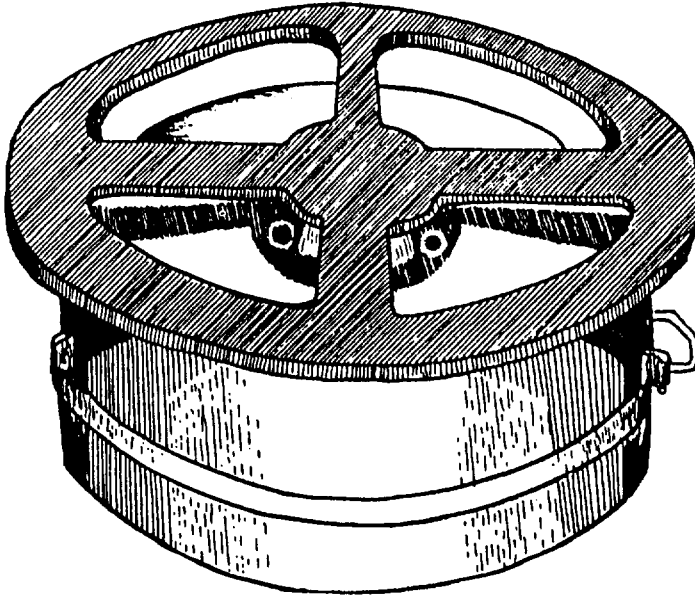

Almost identical to the CHICOM No. 4 Dual-Purpose Mine, this device also has a double-acting fuse. Like the No.4, a pressure of 300 pounds on the pressure spider or a pull of 10 pounds on an attached tripwire will detonate the mine. Slightly larger than the No.4, this mine contains 5 pounds of explosive and has an overall weight of 12 pounds. It is made of metal and coated with creosote for waterproofing.



BOUNDING FRAGMENTATION MINE

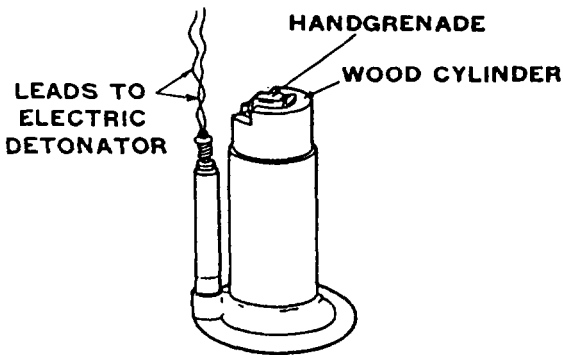

The bounding mine is improvised from expended U.S. M2 bounding mine or M48 trip-flare cases. A wooden cylinder slightly smaller in diameter than the mine case is hollowed out so that a standard grenade can fit inside. The wooden cylinder (with enclosed grenade) is then fitted into the mine case and the grenade's safety pin is extracted. When the mine is detonated, the cylinder and grenade are propelled upward. As the wooden cylinder and grenade separate, the handle flies off the grenade, activating the fuse.



VC "TOE POPPER" MINE



This mine is fabricated of cartridge cases or pieces of pipe of various sizes. It is loaded with a charge of black powder, a primer, and a variety of fragments for missile effect. When the victim steps on the mine, the igniter detonates the black powder charge and propels the fragments upward.



CARTRIDGE TRAP

CARTRIDGE TRAP

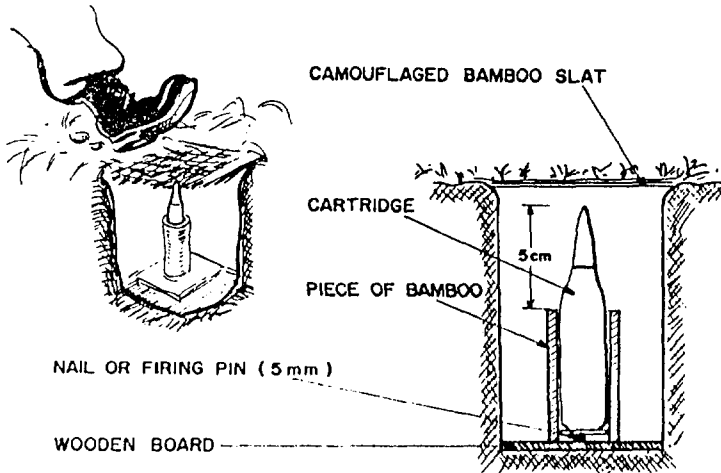

Four simple and easily obtainable components make up this mine; a bamboo tube, a nail, a piece of wood, and any small arms ammunition or M79 round. The piece of wood is used as a base. The bamboo tube is placed upright on the wooden base and a nail is driven up through the wood to penetrate the bottom of the bamboo. The cartridge is then wedged into the bamboo so that the primer is touching the point of the nail. Partially buried along a trail or path, the pressure of a man's foot stepping on the nose of the cartridge forces the primer onto the nail, firing the cartridge.



DIRECTIONAL FRAGMENTATION
MINE (DH-10)



Commonly referred to as a "CHICOM or VC claymore," this mine has characteristics similar to the U.S. M18 Claymore Mine. Fused electrically, it is a command-detonating device designed for employment from ambush or defensive positions. It has a range of 150 to 200 meters and is effective against personnel and thin-skinned vehicles.





POMZ-2 ANTIPERSONNEL MINE

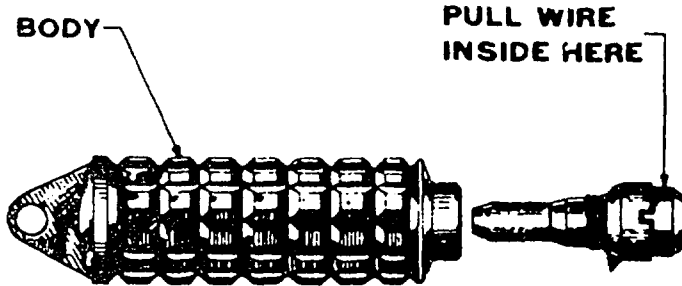

Chinese Communist copies of the Soviet POMZ-2 mine are now being employed by the VC/NVA. Weighing only 4.4 pounds, it is easily carried and can be emplaced quickly. Fused for detonation by tripwire (tension release or pressure release), it can also be rigged electrically for command detonation.

NONEXPLOSIVE BOOBYTRAPS

The idea of nonexplosive boobytraps is as old as man. From the simple earth pit lined with sharpened stakes to highly sophisticated mechanisms of triggered coils and latches, the enemy employs them all. The principle employed is simply to use anything that will catch the victim by surprise.



BARBED-SPIKE PLATE

BARBED-SPIKE PLATE

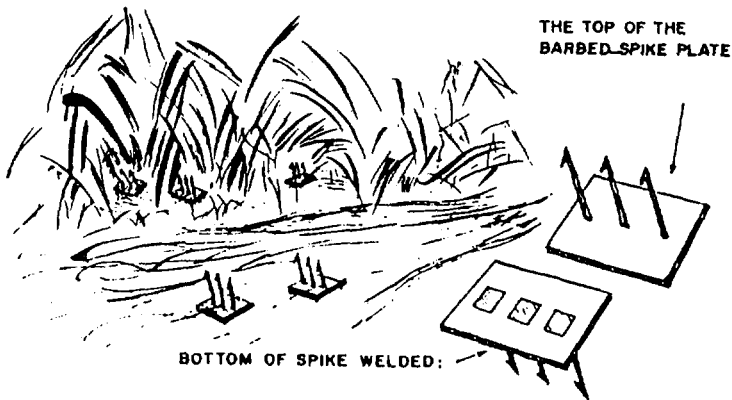

The barbed-spike plate is the basic element of all enemy nonexplosive booby-traps. The plate, a flat piece of wood or metal, is used as a base to fasten any number of barbed spikes. The spikes, ranging in length from several inches to several feet, are fastened securely to the base. When a man steps or falls on the spiked plate, or is struck by one, the spikes will penetrate, producing a serious wound.



SPIKE TRAP BOX

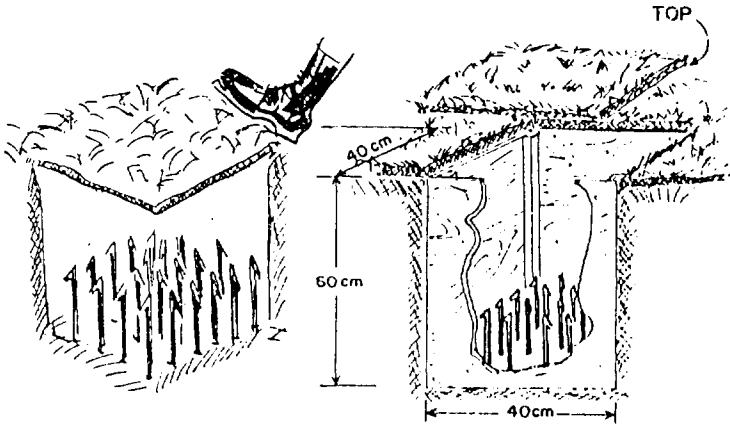

This device is a simple wooden box made of boards joined together with four corner posts. The box has a lightweight top but the bottom is removed. Barbed spikes are placed in the ground at the bottom pointing upward. This trap is usually set up on dirt roads and trails to take advantage of favorable camouflage.



POINTED BAMBOO STAKES

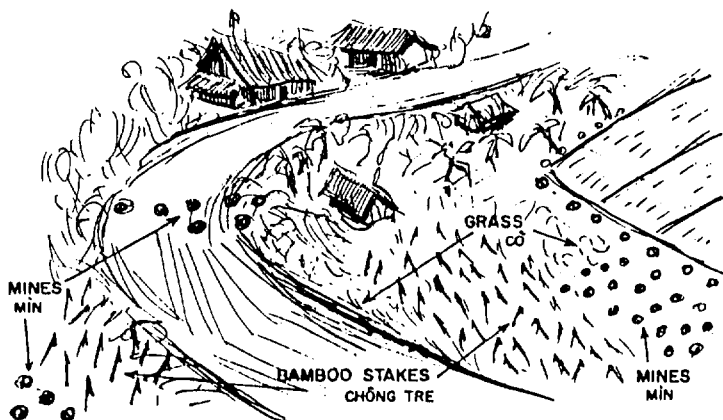

Made of bamboo which has been sharpened, the stakes are stuck in the ground and covered with grass. When a weapon is fired or a grenade thrown, troops seek cover and are impaled.





SPIKE TRAP PIT

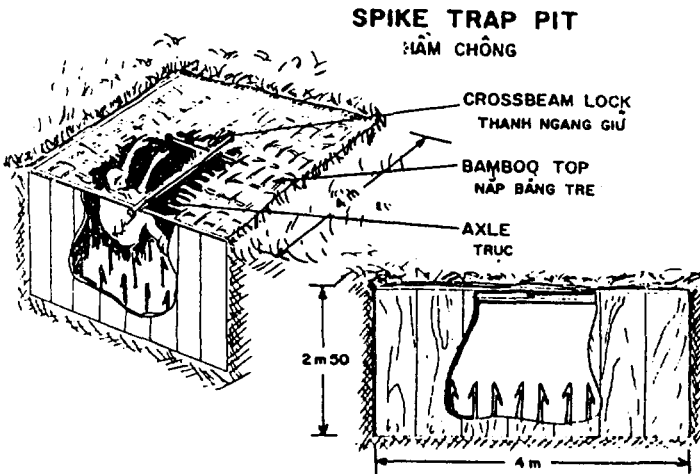

A trap pit is a large trap box with a bamboo top. Stakes are made of sharpened bamboo or barbed spikes and used to line the box. When a man steps on the trap he will fall into the pit. The top turns on an axle; therefore, the trap does not need to be reset to work again. The pit is often prepared as a defensive obstacle and then made safe by locking it in place with a crossbeam (so it can be crossed safely by the enemy) until the desired time of use.



TRAP BRIDGE

TRAP BRIDGE

CUT AT THE MIDDLE AND COVERED WITH MUD

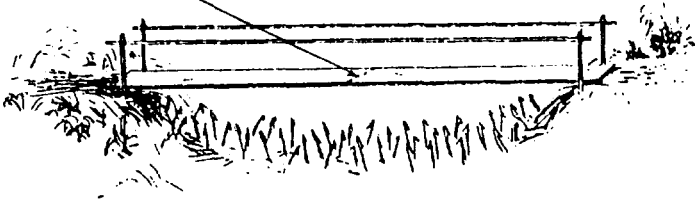

A small footbridge is partially cut in the middle. The cut is then camouflaged with coverings of mud, etc. Barbed spikes or sharpened bamboo stakes are emplaced under the cut, using the water, mud or foilage under the bridge as camouflage. The weight of a man on the bridge will cause it to collapse, tumbling the victim onto the spikes. Like the spike trap pit, bridges can be prepared in this manner, then braced for normal use. At the approach of free world forces the braces are removed.





STEEL ARROW TRAP

STEEL ARROW TRAP

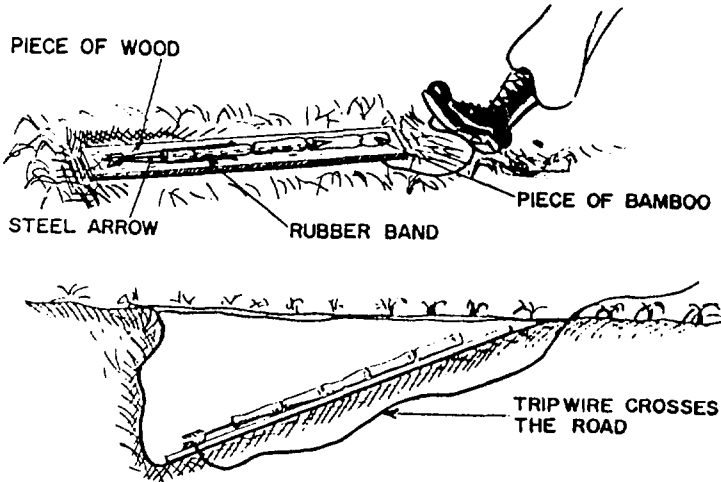

This trap utilizes a bamboo tube (usually about 3 feet long) as a launcher. A steel arrow is placed in the tube. Using a block of wood as the bolt, a strip of strong rubber for power and a catch to lock the rubber strip, the device is fired with a tripwire. When the victim trips the wire, the latch disengages, allowing the rubber strip to launch the arrow.



BAMBOO WHIP

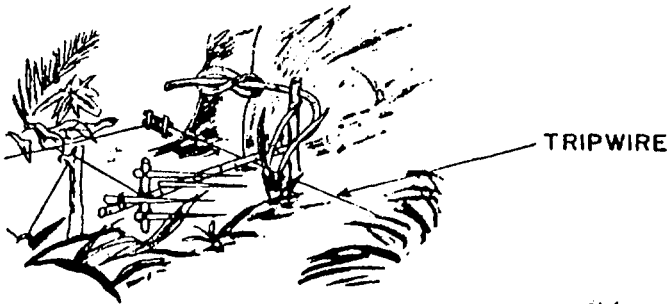

A strip of springy bamboo from 3 to 10 feet in length is used to make a bamboo whip. A barbed-spike plate is secured to the tip of the bamboo (or several of the spikes driven through the bamboo), and the whip is drawn back and secured. A tripwire is then latched to the whip and the wire is strung across the trail. When a man trips the wire, the bamboo is released, and whips around, striking the victim with the spikes.

ANTITANK AND VEHICLE MINES

Mines employed by the enemy against wheeled and tracked vehicles vary from conventional antitank mines of foreign manufacture to rigged duds and locally produced explosive devices. All the industrially produced mines are of the type fused for detonation at from 150 to 400 pounds of pressure. They are buried slightly beneath the surface of the ground. The enemy generally employs these mines as designed but has varied fusing and positioning so that there is no definite pattern.

SOVIET ANTITANK MINE TMB-2

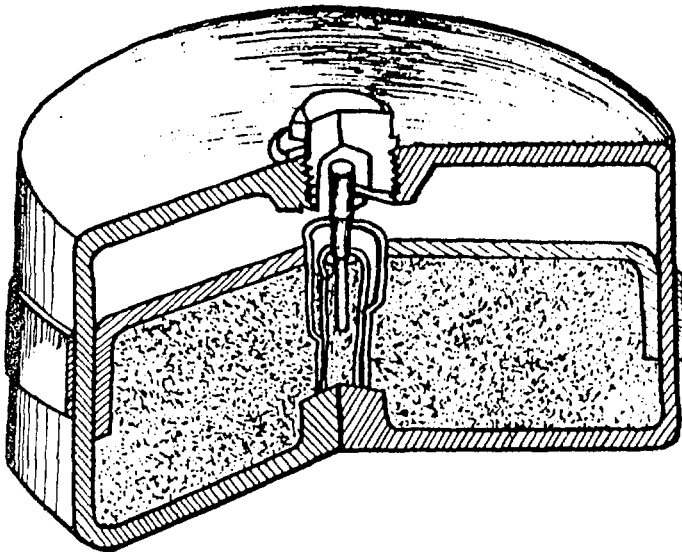

Designed to avoid detection by a mine detector, this mine is constructed of black or brown tar-impregnated cardboard. It is gauged for activation by a force of 350

pounds of pressure. Further, it can be waterproofed by use of wood and plastic sheeting, without losing its nondetection characteristic. It contains 11 pounds of explosive and has an overall weight of 15.4 pounds.



CHINESE COMMUNIST NO. 4
DUAL-PURPOSE MINE

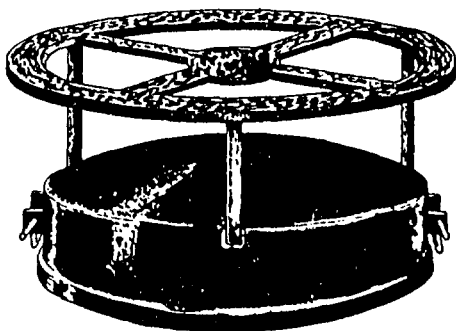

Intended for employment against both vehicles and personnel, this mine incorporates a double-acting fuse that will detonate the mine under either of two circumstances: The first, when a load of 300 pounds of pressure is applied to the pressure spider; the second, when a pull of 10 pounds is exerted on a tripwire fastened to the fuse's striker-retainer pin. Constructed of creosoted metal, it carries 4 pounds of explosive and has an overall weight of about 10 pounds.



CONCRETE FRAGMENTATION MINE

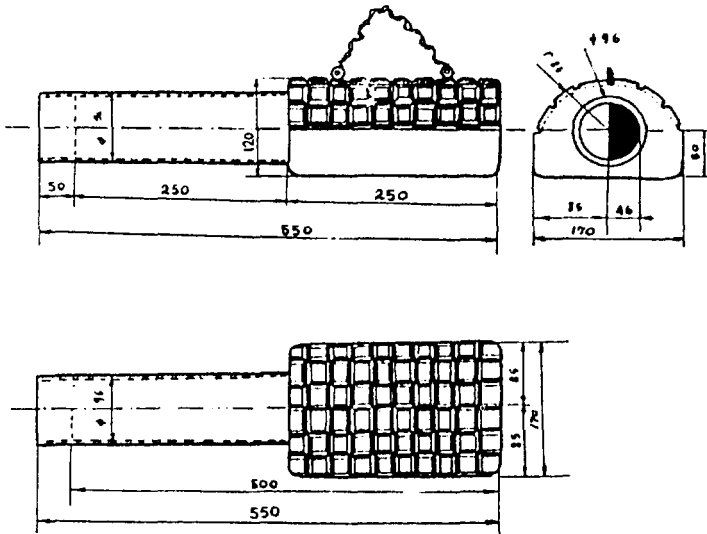

This mine is constructed of explosive encased in a cylindrically shaped concrete shell with a flat side for stable emplacement. A 2-inch-diameter pipe on one end of the mine serves as a carrying handle and detonator housing. The two swivels on top of the mine are used to tie it to an object. Usually employed as a command-detonating mine, it is equipped with an electrical firing device.



NVA CAST-IRON FRAGMENTATION
ANTITANK MINE

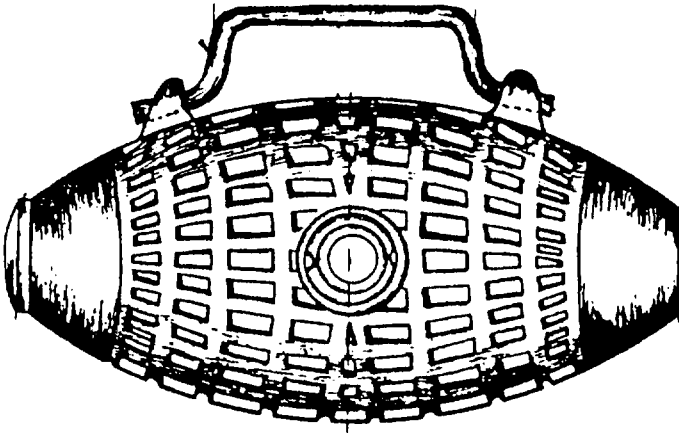

Produced in North Vietnam, this egg-shaped mine is made of cast iron with serrations on its outer surface. Designed for command detonation, the mine is fused with an electrical detonator and weighs 12 pounds.



VC MOUND-SHAPED MINE

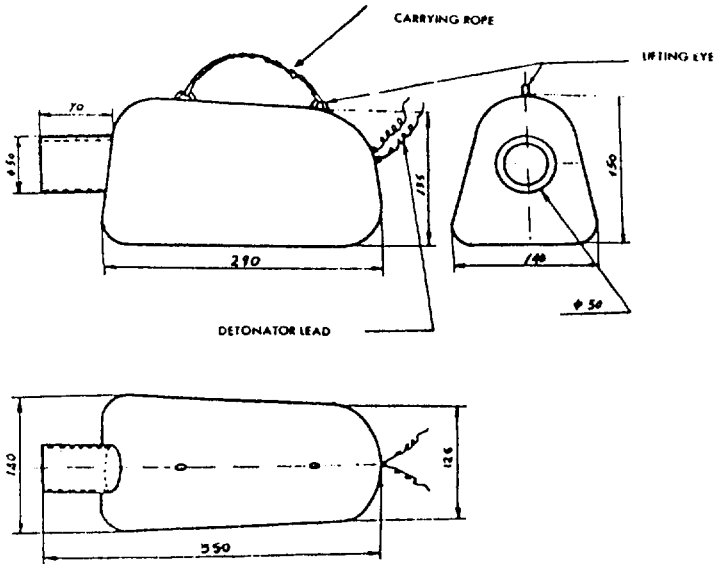

Manufactured locally in VC mine factories, this mine contains an iron-pipe detonator encased in concrete. Another command-detonating mine, it is fused electrically and weighs 13 pounds.



VC ROUND VOLUME MINE

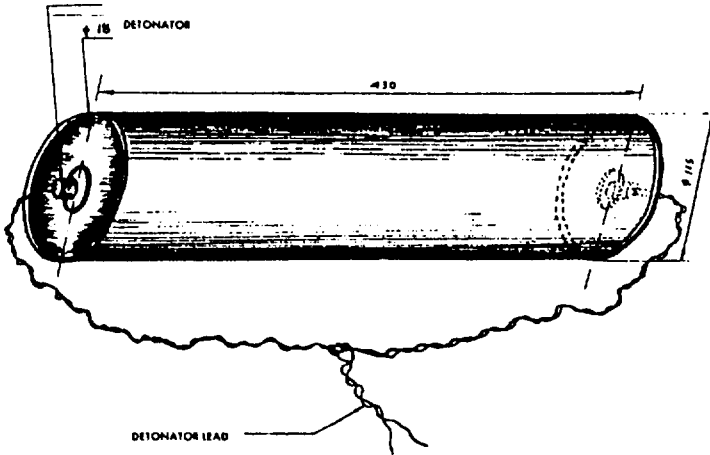

Produced locally in VC mine factories, this mine is a prototype of numerous other VC-manufactured explosive devices. Constructed of sheet metal, with welded seams, it generally weighs about 15 pounds, of which 13 pounds are explosive. Command detonated, it is fused electrically and employs two detonators, one in each end of the mine. The same principle of construction is applied to salvaged artillery shell casings, expended LAAW launchers, and most other devices using metal containers.



VC BOX MINE AND DEMOLITIONS

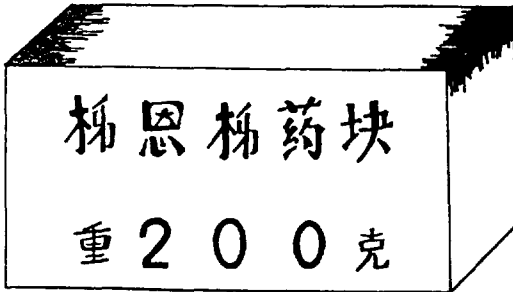

The VC box mine is constructed of wood utilizing discarded ammunition boxes or any scrap material. Mine detectors will not locate these devices. They can be water-proofed with plastic sheeting. Box mines are produced in various sizes but the most common contains about 40 pounds of explosive. The mine can be fused for command detonation or self-detonation by the use of various devices. The explosive charge is usually made up of standard Soviet or Chinese Communist 1-pound demolition blocks.



B-40 ANTITANK BOOBYTRAP

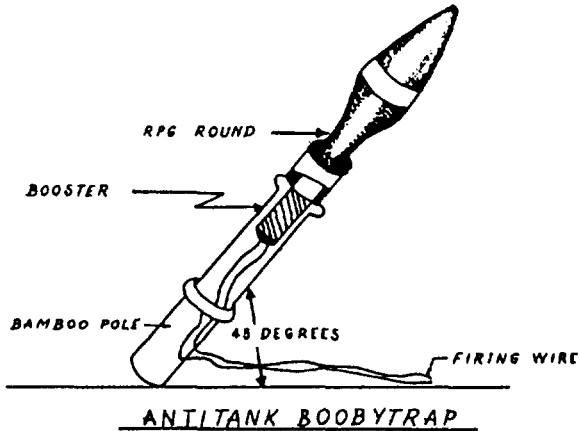

A length of bamboo is emplaced at an angle of 45 degrees along the shoulder of a road. A B-40 rocket is then placed in the bamboo tube and fired electrically by command detonation as the tank or vehicle crosses the line of fire.



SOVIET ANTITANK MINE TM-41

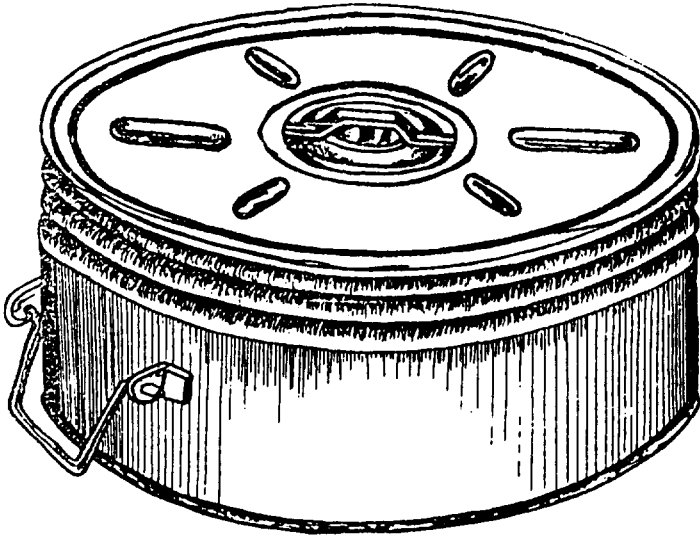

Constructed of blued steel, sometimes painted olive drab or white, the TM-41 carries an explosive charge of 8 pounds and has a total weight of 12 pounds. A force of 350 pounds of pressure on the lid will activate the firing device. With very little additional waterproofing it can remain operational indefinitely.



CHINESE COMMUNIST M1A1
ANTITANK MINE

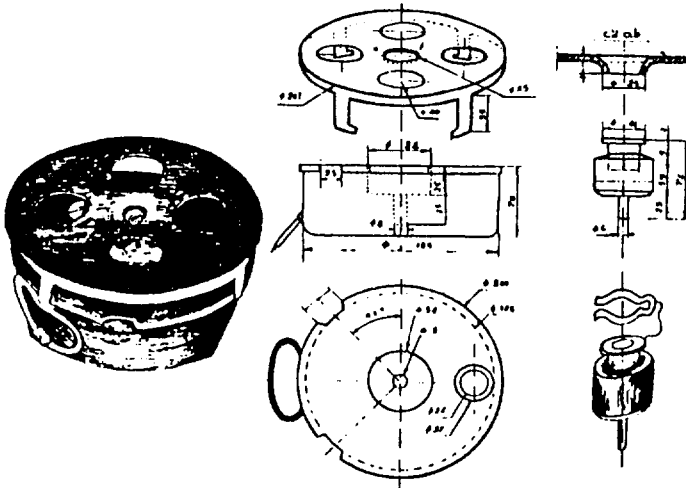

Manufactured in Communist China, this mine is similar to and often mistaken for a U.S. pre-World War II mine. Made of metal, it is painted olive drab with the yellow markings "MINE M1A1-TNT". It is activated by 200 pounds of pressure on the pressure plate. This mine contains 4 pounds of explosive and weighs 11.5 pounds.

ANTIHELICOPTER MINING

The degree of success that the employment of helicopters has had on restricting and containing VC/NVA activities is evidenced by the enemy's efforts to destroy or neutralize these machines. In addition to intense ground fire, the enemy has devised numerous helicopter landing zone destruction systems. Such destruction systems range from the primitive planting of long pointed stakes to imaginative explosive devices. Because of its design, the helicopter is extremely vulnerable to these devices, particularly the rotors and airframe.

HELICOPTER EXPLOSIVE TRAPS

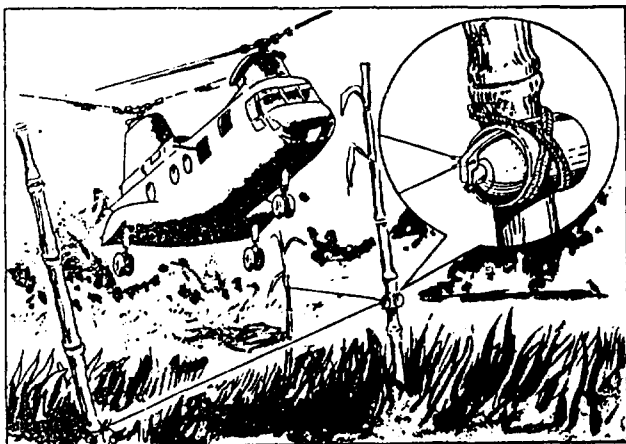

Grenades, artillery/mortar rounds, or any other type of exploding ordnance are mounted in trees or on the surface of the landing zone. The explosive devices are rigged for tripwire detonation and the

wire is strung to loosely emplaced poles. The rotorwash of landing helicopters will blow the poles from their loose position, tripping the device.

A 13-year-old Vietnamese boy recently claimed that the VC had forced him to reconnoiter helicopter landing zones. The boy was instructed by the VC to place handgrenades in the zones with strings wrapped around the levers, pieces of paper attached to the free ends of the strings and the rings (pull rings) pulled. Rotorwash from landing helicopters would then blow the paper, unwrap the string, and release the safety lever.

